



INNOVATIVE DESIGN. CLASSIC RESULTS.

EPC STORMWATER REVIEW COMMENTS ARE  
SHOWN IN ORANGE BOXES WITH BLACK TEXT

**FINAL DRAINAGE REPORT  
FOR  
FOREST LAKES FILING 7  
EL PASO COUNTY, COLORADO**

**December 2021**

Prepared for:  
**FOREST LAKES RESIDENTIAL DEVELOPMENT, LLC**  
2138 Flying Horse Club Dr.  
COLORADO SPRINGS CO 80921  
(719) 592-9333

Prepared by:  
**CLASSIC CONSULTING ENGINEERS & SURVEYORS**  
619 N. CASCADE AVENUE, SUITE 200  
COLORADO SPRINGS CO 80903  
(719) 785-0790

Job no. 1175.70  
PCD File # SF-21-49



**FINAL DRAINAGE REPORT FOR FOREST LAKES FILING 7**

**ENGINEER'S STATEMENT:**

The attached drainage plan and report were prepared under my direction and supervision and are correct to the best of my knowledge and belief. Said drainage report has been prepared according to the criteria established by the El Paso County for drainage reports and said report is in conformity with the master plan of the drainage basin. I accept responsibility for any liability caused by any negligent acts, errors, or omissions on my part in preparing this report.

\_\_\_\_\_  
Kyle R Campbell, Colorado P.E. #29794

\_\_\_\_\_  
Date

**DEVELOPER'S STATEMENT:**

I, the developer, have read and will comply with all of the requirements specified in this drainage report and plan.

Business Name: Forest Lakes Residential Development, LLC

By: \_\_\_\_\_

Title: \_\_\_\_\_

Address: 2138 Flying Horse Club Dr.

Colorado Springs, CO 80921

**EL PASO COUNTY ONLY:**

Filed in accordance with the requirements of the Drainage Criteria Manual, Volumes 1 and 2, El Paso County Engineering Criteria Manual and Land Development Code as amended.

\_\_\_\_\_  
Jennifer Irvine, P.E.  
County Engineer / ECM Administrator

\_\_\_\_\_  
Date



# FINAL DRAINAGE REPORT FOR FOREST LAKES FILING 7

## TABLE OF CONTENTS:

PURPOSE	Page 4
PROJECT DESCRIPTION	Page 4
PREVIOUS REPORTS	Page 5
SOILS & GEOLOGY	Page 5
DRAINAGE CRITERIA	Page 5
FLOODPLAIN STATEMENT	Page 6
EXISTING DRAINAGE CONDITIONS	Page 6
PROPOSED DRAINAGE CONDITIONS	Page 7
STORMWATER QUALITY (FOUR STEP PROCESS)	Page 22
DRAINAGE AND BRIDGE FEES	Page 23
CONSTRUCTION COST OPINION	Page 24
SUMMARY	Page 25
REFERENCES	Page 26

## APPENDICES

VICINITY MAP
SOILS MAP (S.C.S. SURVEY)
F.E.M.A. MAP
EXISTING CONDITIONS CALCULATIONS
DEVELOPED CONDITIONS CALCULATIONS
DETENTION POND 'A'
HYDRUALIC GRADE LINE (HGL) CALCULATIONS
DRAINAGE MAPS



## **FINAL DRAINAGE REPORT FOR FOREST LAKES FILING 7**

### **PURPOSE**

This document is the Final Drainage Report for Forest Lakes Filing 7. The purpose of this report is to identify onsite and offsite drainage patterns, define areas tributary to the proposed full spectrum detention and water quality facility the site, and to safely route developed storm water runoff via a proposed storm sewer system. The proposed Filings 5, 6, & 7 development shall be in adherence to the El Paso County approved Master Development Drainage Plan and Amendment/Preliminary Drainage Report for Forest Lakes as well as current County Drainage Criteria.

### **PROJECT DESCRIPTION**

The Forest Lakes Filing 7 is 82.504 acres of a phased master planned community located in northern El Paso County, Colorado. The Filing 7 limits contain a large open space Tract A, 36.02 acres of an existing steep hill being encompassed by the proposed and existing Mesa Top Drive. Filing 7 also has a large open space Tract D, 13.20 acres of existing hill side separating the Rocky Mountain Open Space (US Government owned) and the proposed home lots of Filing 7. The property lies to the east of Pike National Forest, north of the United States Air Force Academy, west of Interstate 25 and south of the Town of Monument. The Forest Lakes Filing 7 property is located in Section 29 of Township 11 South, Range 67 West of the Sixth Principal Meridian. The proposed Filing 7 is within the far westerly area, east of Filing 6 and continuation of Mesa Top Drive. The Filing 7 boundary is north of Beaver Creek, a tributary to Monument Creek. The site is located within the Beaver Creek Drainage Basin.

A previous MDDP Amendment and Preliminary Drainage Report for Filings 5, 6, 7 has been approved by the County and defines existing and updated developed peak flow data for the 5-year and 100-year recurrence intervals within the Filings 5, 6, & 7 portions of the property. The previous report established the overall drainage design information and identified the required storm drainage and flood control facilities within the Filings 5, 6, & 7 properties. Final development of Filing 7 is consistent with this approved report with no changes to the overall drainage patterns, lot layout, and roadway design. The vicinity map for the Filings 7 area is presented in the Appendix of this report.

As the limits of Filing 7 are outside of the existing drainage corridors, there is no grading proposed within the existing wetlands, mouse habitat, and/or 100-year floodplain limits. The drainage maps in the Appendix of this report show the existing wetland limits, Preble's Jumping Mouse habitat limits, and effective FEMA floodplain.

## **PREVIOUS REPORTS**

The latest and most applicable previously approved drainage study is the following:

1. "Master Development Drainage Plan Amendment and Preliminary Drainage Report for Forest Lakes (Filing 5, 6, 7)," by Classic Consulting Engineers & Surveyors LLC, approved April 1, 2019.
2. "Final Drainage Report for Forest Lakes Filing No. 5," by Classic Consulting Engineers & Surveyors, LLC, approved June 9, 2020.
3. "Final Drainage Report for Forest Lakes Filing 6," by Classic Consulting Engineers & Surveyors, LLC, approved May 11, 2021.

## **SOILS AND GEOLOGY**

The soils within the Forest Lakes Filing 7 and tributary area are Hydrologic Soil Group B, mostly Jarre-Tecolote complex and Peyton-Pring complex (See Appendix for Soil Map).

## **DRAINAGE CRITERIA**

Hydrologic calculations were performed using the City of Colorado Springs/El Paso County Drainage Criteria Manual, as revised in November 1991 and October 1994. Full Spectrum Detention and Stormwater quality analysis, Extended Detention Basin (EDB) design, are per the Urban Drainage and Flood Control District Manual and UD-BMP Version 3.05 spreadsheet. The Rational Method was used to estimate stormwater runoff from the developed project and tributary to the proposed full spectrum detention/water quality pond. Developed Conditions Basins E, S-1 thru S-5, and off-site Basins within Pike National Forest calculate the overland flow length (time of concentration) using undeveloped criteria (300' max. length) and not 100' for developed/urban land use. This is due to the large amount



of un-developed steep sloped tributary area within each of these basins that do not and will not contain houses, driveways, or any other type of impervious developed surface. Using this overland flow more accurately defines the peak time for runoff to reach the downstream facilities. The UDFCD UD-Inlet excel workbook was used to verify street capacities, size sump inlets, and calculate interception and flow-by rates of at-grade inlets. The full spectrum detention/water quality pond outlet was designed using the UDFCD UD-Detention Version 4.04 excel workbook. The UD-Sewer computer program was used to calculate the hydraulic grade line (HGL) within the storm sewer system. An overall tributary area exhibit is included to show the various types of pervious and impervious areas established to determine the overall imperviousness of the 38.54 acres tributary to the proposed full spectrum detention/water quality facility (Pond A).

#### **FLOODPLAIN STATEMENT**

No portion of the Forest Lakes Filing 7 development is located within a floodplain as determined by the Flood Insurance Rate Maps (F.I.R.M.) Map Numbers 08041 CO266G & CO258G, effective date, December 7, 2018 (See Appendix for overlay exhibit). The entire parcel is outside of jurisdictional wetlands limits and Preble's Jumping Mouse Habitat limits.

#### **EXISTING DRAINAGE CONDITIONS**

As defined in the MDDP Amendment and Preliminary Drainage Report, there are multiple off-site basins and open space areas tributary to the Filings 5-7 area. Within this report is the Existing Conditions of the area directly tributary and that of Filing 7 of Forest Lakes. An Existing Conditions Drainage Map is included in the Appendix. Please see previous Filing 5 & 6 Final Drainage Reports for discussion of existing conditions within Beaver Creek and east of the proposed development.

**DESIGN POINT 1 ( $Q_5 = 5.6$  cfs and  $Q_{100} = 15.2$  cfs)** is the overall runoff from Filing 6 Mesa Top Drive construction and the Forest Lakes Metro District water tank and access road, Basin EX-A (3.98 acres). This runoff drains to the end of the temporary cul-de-sac and through a riprap rundown to existing grade where it continues thru Basin EX-B to the temporary sediment basin at Design Point 4.

**DESIGN POINT 2 ( $Q_5 = 23.1$  cfs and  $Q_{100} = 155.4$  cfs)** is the existing conditions runoff from Basins OS-1, 66.39 acres of Pike National Forest Land (open space) that drains across the western boundary of Forest Lakes Filing 7 and to the existing temporary sediment basin at Design Point 4. This land consists of dense forest and steep grades with minimal concentration points along the boundary line.

**DESIGN POINT 3 ( $Q_5 = 0.4$  cfs and  $Q_{100} = 2.8$  cfs)** is the existing conditions runoff from off-site Basin EX-D, 1.00 acres of land located at the southwest corner of the Filing 7 boundary and draining onto the proposed site. This runoff drain into Basin EX-B and also to the temporary sediment basin at DP-4.

**DESIGN POINT 4 ( $Q_5 = 44.3$  cfs and  $Q_{100} = 280.0$  cfs)** is the existing runoff at the terminus of basin EX-B and the temporary sediment basins installed with the overlot grading of Filings 5-7. Specifically, this runoff consists of that from Design Points 1-3 and Basin EX-B, 60.79 acres of onsite Forest Lakes Filing 7 land, including a large portion of the existing large 'hill' located on the property. This area/runoff drains directly into the Beaver Creek Channel and Preble's Jumping Mouse limits being released from the temporary sediment basin in place from previous grading activities.

**DESIGN POINT 5 ( $Q_5 = 13.8$  cfs and  $Q_{100} = 92.4$  cfs)** is the existing conditions runoff from Basins EX-C, 44.59 acres of the existing large 'hill' located within Filing 7 boundaries and the adjacent and under construction Forest Lakes Filing No. 6 subdivision. This runoff drains into the existing Full Spectrum Detention/Water Quality Facility Pond B, constructed with Filing No. 6. From this pond, the runoff drains directly into the adjacent jurisdictional wetlands, Preble's Jumping Mouse, and Beaver Creek Channel limits. For more description on the drainage within Basin EX-C, please refer to the Developed Conditions of the "Final Drainage Report for Forest Lakes Filing No. 6," by Classic Consulting.

## **PROPOSED DRAINAGE CONDITIONS**

Developed runoff from Filing 7 will be collected in a public storm system and piped into the Privately owned and maintained full spectrum detention/water quality facility that will detain and treat the developed runoff prior to releasing at or below historic rates to the downstream channel. As previously mentioned, the rational method was used to estimate developed runoff values. All storm sewer inlets and pipes collecting runoff within the County right-of-way will be 'Public'. All storm sewer outside of

right-of-way, including the pond outfall pipe, is 'Private' as is the proposed full spectrum detention facility. Private facilities will be owned and maintained by the Forest Lakes Metropolitan District.

Due to the extreme topography of the proposed development (84' of fall within the right-of-way), adherence to the maximum pipe velocity of 18 feet per second is not possible in numerous locations. As in previous Forest Lakes Filings and per the pipe manufacturer's specifications, the maximum allowable velocity was increased to 24 feet per second. The DCM also limits the use of drop manholes larger than 1 foot in typical situations. Again, due to the extreme topography of the site and the limitation of the allowable pipe velocities, the use of larger drop manholes had to be implemented throughout the incoming pipe system to Pond A and the bypass system along the back of the lots and open space interface. HGL grade line calculations are included in the Appendix in support of the construction drawings for the proposed Public and Private storm systems.

Unresolved-Please provide deviation for velocities greater than 18 fps in storm system.

Per the current El Paso County Drainage Criteria for stormwater capacity within street sections, the following summaries of Figures 7-7 applies: all proposed roads are Residential.

<i>Street Type</i>	<i>Allowable – Initial Storm (5 yr)</i>	<i>Allowable–Major Storm (100 yr)</i>
Residential w/Ramp Curb	1.5% street slope = 10 cfs 2% street slope = 12 cfs 4% street slope = 16.5 cfs 6% street slope = 19.5 cfs 8% street slope = 17.8 cfs 10% street slope = 16.5 cfs No curb overtopping.	1.5% street slope = 46 cfs 2% street slope = 44 cfs 4% street slope = 36 cfs 6% street slope = 32 cfs 8% street slope = 29 cfs 10% street slope = 27.5 cfs 12" maximum depth at flowline.
Residential w/Vertical Curb (6" Vertical Curb)	1.5% street slope = 13 cfs 2% street slope = 15 cfs 4% street slope = 20.5 cfs 6% street slope = 18 cfs 8% street slope = 16.8 cfs 10% street slope = 15.7 cfs No curb overtopping.	1.5% street slope = 45 cfs 2% street slope = 43 cfs 4% street slope = 35 cfs 6% street slope = 31 cfs 8% street slope = 28 cfs 10% street slope = 26.5 cfs 12" maximum depth at flowline.





At-grade inlets and sump (low-points) were designed in a way that street capacity is not an issue anywhere within the proposed Filing or surrounding and future roadways. Street capacity has also been verified at each design point by using the UD-Inlet Excel workbook (located in Appendix) from Urban Drainage Flood Control District (UDFCD). Inlet sizing is also per the UD-Inlet Excel workbook. Drainage from individual lots are assumed to travel in side-lot swales to the street. One Site-Level Low Impact Development form (IRF form) is included in the Appendix of this report, for the basins that discharge to the proposed full spectrum detention and water quality Pond A. The area of Forest Lakes Filing 7 that is tributary to the downstream storm system and Pond B of Forest Lakes Filing No. 6 were constructed per the Filing 6 report and assumptions and therefore updated IRF and Pond calculations are not provided in this report. A detailed description of the developed flows for Forest Lakes Filing No. 7 is as follows:

**DESIGN POINT 1A ( $Q_5 = 9.3$  cfs and  $Q_{100} = 23.1$  cfs)** is the developed runoff from Design Point 8 and Basin A1, 5.15 acres of proposed Filing 7 home lots, open space (hill area), and local roadway (Mesa Top Drive). This Design Point was previously analyzed in the Filing 6 report with no proposed changes. A 15' CDOT Type R at-grade inlet is proposed at this location intercepting  $Q_5 = 8.8$  cfs and  $Q_{100} = 15.1$  cfs while the remaining runoff will continue south-east along the concrete pan at the Ute Mountain Court intersection to Design Point 1B. Pipe 4, proposed 24" RCP, conveys the intercepted runoff to an adjacent manhole along the proposed Mesa Top Drive storm main (See DP-11 for downstream pipe continuation).

**DESIGN POINT 1B ( $Q_5 = 4.4$  cfs and  $Q_{100} = 21.8$  cfs)** is the developed runoff from Basin B1, 4.69 acres of proposed Filing 7 home lots along Mesa Top Drive, open space (hill area), and local roadway and the flow-by runoff from DP-1A. A 15' CDOT Type R at-grade inlet is proposed at this location intercepting  $Q_5 = 4.4$  cfs and  $Q_{100} = 14.6$  cfs while the remaining runoff will continue south-east along the proposed Mesa Top Drive curb to Design Point 2. Pipe 15, proposed 24" RCP, conveys the intercepted runoff to an adjacent manhole along the proposed Mesa Top storm main (Pipe 16). Pipe 16 (42" RCP) contains a total runoff rate of  $Q_5 = 37.5$  cfs and  $Q_{100} = 86.7$  cfs and continues southeast down Mesa Top Drive until a 90 degree turn at Foothills Flash Court after the connection of DP-2.

**DESIGN POINT 2 ( $Q_5 = 3.6$  cfs and  $Q_{100} = 17.6$  cfs)** is the developed runoff from Basin B2, 3.16 acres of proposed Filing 7 home lots along Mesa Top Drive, open space (hill area), and local roadway and the flow-by runoff from DP-1B. A 15' CDOT Type R at-grade inlet is proposed at this location intercepting  $Q_5 = 3.6$  cfs and  $Q_{100} = 13.1$  cfs while the remaining runoff will continue east along the Mesa Top Drive curb to Design Point 3. Pipe 17, proposed 24" RCP, conveys the intercepted runoff to an adjacent manhole with Pipe 16/Mesa Top Drive main. Pipe 18 (42" RCP) is the outfall pipe to this junction manhole and contains a total runoff rate of  $Q_5 = 40.9$  cfs and  $Q_{100} = 99.2$  cfs and drains south along Foothills Flash Court toward Design Points 15 & 16 and ultimately to the proposed Pond A at Design Point 19.

**DESIGN POINT 3 ( $Q_5 = 5.6$  cfs and  $Q_{100} = 22.4$  cfs)** is the developed runoff from Basin C, 6.00 acres of proposed Filing 7 home lots along Mesa Top Drive, open space (hill area), and local roadway and the flow-by runoff from DP-2. A 15' CDOT Type R at-grade inlet is proposed at this location intercepting  $Q_5 = 5.6$  cfs and  $Q_{100} = 14.9$  cfs while the remaining runoff will continue east along the proposed curb to Design Point 4. Pipe 36, proposed 24" RCP, conveys the intercepted runoff to the east within Mesa Top Drive to a junction manhole, combining with runoff from Pipes 37 and 38 (DP-4 & DP-6A).

**DESIGN POINT 4 ( $Q_5 = 3.5$  cfs and  $Q_{100} = 17.7$  cfs)** is the developed runoff from Basin D, 3.27 acres of proposed Filing 7 home lots along Mesa Top Drive, open space (hill area), and local roadway and the flow-by runoff from DP-3. A 15' CDOT Type R at-grade inlet is proposed at this location intercepting  $Q_5 = 3.5$  cfs and  $Q_{100} = 13.1$  cfs while the remaining runoff will continue east along the proposed curb onto the existing Mesa Top Drive curb constructed with Filing 6 and to the sump inlet at Design Point 5 (Filing 6). A proposed 24" RCP lateral (Pipe 37) will convey the intercepted runoff to the adjacent storm manhole, combining with Pipe 36 and Pipe 38 (from Design Point 6A).

**DESIGN POINT 5 ( $Q_5 = 2.7$  cfs and  $Q_{100} = 17.6$  cfs)** is the developed runoff from Basin E, 5.09 acres of open space (hill area) and local roadway, and the flow-by runoff from DP-4. An existing 15' CDOT Type R sump inlet was installed at this location with Filing 6. The entirety of this runoff will be collected by this inlet and the runoff routed via an existing 24" RCP (Pipe 7) to an adjacent storm manhole, combining with Pipes 39 and 8. See previously approved Filing No. 6 report for more discussion. The flow rate with developed conditions Filing 7 is slightly lower than assumed in the Filing 6 report and therefore no

additional downstream analysis is warranted. The overflow path for this sump inlet (in case of inlet failure) is to overtop the crown of roadway and the high point at the existing intersection of Mesa Top Drive and Timber Trek Way, and to drain east then north, along Timber Trek Way to downstream facilities.

**DESIGN POINT 6A ( $Q_5 = 4.5$  cfs and  $Q_{100} = 8.9$  cfs)** is the developed runoff from Basin F1, 1.65 acres of proposed Filing 7 home lots and local roadway (Mesa Top Drive). This Design Point was analyzed in the previous Filing 6 report with no proposed changes. A 5' CDOT Type R at-grade inlet is proposed at this location intercepting  $Q_5 = 2.7$  cfs and  $Q_{100} = 3.7$  cfs while the remaining runoff will continue east along the proposed curb to the existing sump inlet at Design Point 6B. A proposed 18" RCP lateral (Pipe 38) conveys the intercepted runoff to the adjacent storm manhole, combining with Pipes 36 and Pipe 37 (from Design Point 4). Pipe 39 (30" RCP  $Q_5 = 11.3$  cfs and  $Q_{100} = 30.9$  cfs) conveys the combined runoff from this manhole to the east, where it connects with the 30" pipe stub installed with the existing Filing 6 subdivision. The flow rate with developed conditions Filing 7 is slightly lower than assumed in the Filing 6 report and therefore no additional downstream analysis is warranted.

**DESIGN POINT 6B ( $Q_5 = 4.2$  cfs and  $Q_{100} = 10.1$  cfs)** is the developed runoff from Basin F2, 0.91 acres of proposed Filing 7 home lots and local roadway (Mesa Top Drive), and the flow-by runoff from DP-6A. A 10' CDOT Type R sump inlet was installed at this location with Filing 6. The entirety of this runoff is collected by this inlet and the runoff routed via an existing 18" RCP (Pipe 8) to an existing adjacent storm manhole, combining with Pipes 39 and 7. Pipe 9 (existing 36" RCP  $Q_5 = 17.6$  cfs and  $Q_{100} = 55.3$  cfs) conveys the combined runoff from this manhole to the downstream Filing No. 6 facilities (Pond B). See previously approved report for more description of downstream flow patterns. The flow rate with developed conditions Filing 7 is slightly lower than assumed in the Filing 6 report and therefore no additional downstream analysis is warranted.

**DESIGN POINT 7 ( $Q_5 = 3.3$  cfs and  $Q_{100} = 9.6$  cfs)** is the developed runoff from Basins Z1 & Z2 within Forest Lakes Filing No. 6 and tributary to the north-west corner of the Filing 7 development. Basin Z1 is 1.30 acres of the Forest Lakes Metro District Water tank and access road constructed with Filing 6 off of Mesa Top Drive. Basin Z2 is 1.40 acres of an existing large lot Filing 6 home and existing Mesa Top Drive

that drains south onto the Filing 7 property. There are no changes proposed in either of these existing basins and the runoff continues along proposed Mesa Top Drive to the at-grade inlet at Design Point 9.

**DESIGN POINT 8 ( $Q_5 = 1.7$  cfs and  $Q_{100} = 4.0$  cfs)** is the developed runoff from Basin A2 within Forest Lakes Filing No. 6 and tributary to the north-west corner of the Filing 7 development. Basin A2 is 1.01 acres of existing Filing 6 home lots and existing Mesa Top Drive that drains south onto the Filing 7 property. There are no changes to this existing basin and the runoff continues along proposed Mesa Top Drive to the at-grade inlet at Design Point 1A.

**DESIGN POINT 9 ( $Q_5 = 7.6$  cfs and  $Q_{100} = 19.6$  cfs)** is the developed runoff from Design Point 7 and Basin G, 2.50 acres of proposed Filing 7 home lots, open space (behind lots), and local roadway (Mesa Top Drive). A 15' CDOT Type R at-grade inlet is proposed at this location intercepting  $Q_5 = 7.5$  cfs and  $Q_{100} = 13.8$  cfs while the remaining runoff will continue south along the concrete pan at the Horse Trade Place intersection to Design Point 10. Pipe 1, proposed 24" RCP, conveys the intercepted runoff to the south to an adjacent manhole combining with Pipe 2 from Design Point 10.

**DESIGN POINT 10 ( $Q_5 = 5.6$  cfs and  $Q_{100} = 18.5$  cfs)** is the developed runoff from Basin H, 3.11 acres of proposed Filing 7 home lots, open space (behind lots), and local roadway (Horse Trader Place). A 15' CDOT Type R at-grade inlet is proposed at this location intercepting  $Q_5 = 5.6$  cfs and  $Q_{100} = 13.4$  cfs while the remaining runoff will continue south along the proposed Mesa Top Drive curb to Design Point 11. Pipe 2, proposed 24" RCP, conveys the intercepted runoff to an adjacent manhole combining with Pipe 1. Pipe 3 (30" RCP  $Q_5 = 13.1$  cfs and  $Q_{100} = 27.2$  cfs) conveys the combined runoff from this manhole south within Mesa Top Drive toward Design Point 11.

**DESIGN POINT 11 ( $Q_5 = 2.0$  cfs and  $Q_{100} = 9.2$  cfs)** is the developed runoff from Basin J1, 0.92 acres of proposed Filing 7 home lots and local roadway (Mesa Top Drive). A 10' CDOT Type R at-grade inlet is proposed at this location intercepting  $Q_5 = 2.0$  cfs and  $Q_{100} = 6.9$  cfs while the remaining runoff will continue south along the proposed Mesa Top Drive curb to Design Point 11. Pipe 5, proposed 18" RCP, conveys the intercepted runoff to an adjacent manhole combining with Pipes 3 & 4. Pipe 6 (36" RCP  $Q_5 = 23.4$  cfs and  $Q_{100} = 48.3$  cfs) conveys the combined runoff from this manhole southeast within Mesa

Top Drive to a junction manhole with the storm main in Mountain Ledge Lane. (See Design Point 14 for continuation of pipe discussion).

**DESIGN POINT 12 ( $Q_5 = 4.3$  cfs and  $Q_{100} = 9.7$  cfs)** is the developed runoff from Basin K, 2.30 acres of proposed Filing 7 home lots, open space (behind lots), and local roadway (Mountain Ledge Lane). A 10' CDOT Type R at-grade inlet is proposed at this location intercepting  $Q_5 = 4.2$  cfs and  $Q_{100} = 7.1$  cfs while the remaining runoff will drain east along the Mountain Ledge Lane curb to Design Point 13. Pipe 10, proposed 18" RCP, conveys the intercepted runoff to the east within Mountain Ledge Lane to junction manhole combining with Pipes 11 & 12.

**DESIGN POINT 13 ( $Q_5 = 2.8$  cfs and  $Q_{100} = 11.4$  cfs)** is the developed runoff from Basin J2, 1.65 acres of proposed Filing 7 home lots, open space (between lots), and local roadway (Mountain Ledge Lane). The flow-by from the at-grade inlets at Design Points 11 & 12 also drains to this sump inlet. A 10' CDOT Type R sump inlet is proposed at this location intercepting the entirety of the runoff. Pipe 11, proposed 18" RCP, conveys the intercepted runoff to a junction manhole within Mountain Ledge Lane combining with Pipes 10 & 12. In the event of inlet failure, the emergency overflow path is to overtop the crown of the roadway and adjacent high point at the south curb return of Mesa Top Drive and Mountain Ledge Lane and drain to the southeast toward Design Points 15 & 16.

**DESIGN POINT 14 ( $Q_5 = 3.3$  cfs and  $Q_{100} = 6.6$  cfs)** is the developed runoff from Basin L, 1.20 acres of proposed Filing 7 home lots and local roadway (Mountain Ledge Lane). A 10' CDOT Type R sump inlet is proposed at this location intercepting the entirety of the runoff. Pipe 12, proposed 18" RCP, conveys the intercepted runoff to a junction manhole within Mountain Ledge Lane combining with Pipes 10 & 11. Pipe 13 (30" RCP  $Q_5 = 10.0$  cfs and  $Q_{100} = 24.4$  cfs) conveys the combined runoff from this manhole northeast within Mountain Ledge Lane to a junction manhole with the storm main in Mesa Top Drive (Pipe 6). Pipe 14 (42" RCP  $Q_5 = 33.1$  cfs and  $Q_{100} = 72.1$  cfs) conveys the combined runoff from the Mesa Top Drive/Mountain Ledge Lane intersection to the southeast within Mesa Top Drive. Downstream of this intersection, the Mesa Top Drive storm main combined with the lateral from Design Point 1B (see DP-1B for continuation of pipe discussion). In the event of inlet failure, the emergency overflow path is

to overtop the crown of the roadway and adjacent high point at the south curb return of Mesa Top Drive and Mountain Ledge Lane and drain to the southeast toward Design Points 15 & 16.

**DESIGN POINT 15 ( $Q_5 = 3.2$  cfs and  $Q_{100} = 6.5$  cfs)** is the developed runoff from Basin M, 1.19 acres of proposed Filing 7 home lots and local roadway (Foothills Flash Court and Mesa Top Drive), and from Basin M2, 0.18 acres of Mesa Top Drive that drains onto Foothills Flash Court and to this design point. A 5' CDOT Type R sump inlet is proposed at this location intercepting the entirety of the runoff. Pipe 21, proposed 18" RCP, conveys the intercepted runoff to a junction manhole within Foothills Flash Court combining with Pipe 20 (42" RCP). Pipe 22 (48" RCP  $Q_5 = 44.7$  cfs and  $Q_{100} = 106.9$  cfs) conveys the combined runoff from this manhole southwest within Foothills Flash Court to a junction manhole with Pipe 24 from Design Point 18. In the event of inlet failure, the emergency overflow path is to overtop the high point to the south and continue southwest along Foothills Flash Court toward Design Points 17 & 18.

**DESIGN POINT 16 ( $Q_5 = 1.2$  cfs and  $Q_{100} = 2.4$  cfs)** is the developed runoff from Basin Q, 0.42 acres of proposed Filing 7 home lots and local roadway (Foothills Flash Court). A 5' CDOT Type R sump inlet is proposed at this location intercepting the entirety of the runoff. Pipe 19, proposed 18" RCP, conveys the intercepted runoff to a junction manhole within Foothills Flash Court combining with Pipe 18 (42" RCP). Pipe 20 (42" RCP  $Q_5 = 41.7$  cfs and  $Q_{100} = 100.7$  cfs) conveys the combined runoff from this manhole southwest within Foothills Flash Court to a junction manhole with Pipe 21 from Design Point 15. In the event of inlet failure, the emergency overflow path is to overtop the high point to the south and continue southwest along Foothills Flash Court toward Design Points 17 & 18.

**DESIGN POINT 17 ( $Q_5 = 6.8$  cfs and  $Q_{100} = 15.1$  cfs)** is the developed runoff from Basin N, 3.65 acres of proposed Filing 7 home lots and local roadway (Foothills Flash Court). A 15' CDOT Type R sump inlet is proposed at this location intercepting the entirety of the runoff. Pipe 23, proposed 24" RCP, conveys the intercepted runoff to the sump inlet across the street at Design Point 18. In the event of inlet failure, the emergency overflow path is to overtop the crown of the roadway and the curb south of DP-18 into the open space/drainage tract and ultimately to Pond A/Design Point 19.

**DESIGN POINT 18 ( $Q_5 = 4.1$  cfs and  $Q_{100} = 8.2$  cfs)** is the developed runoff from Basin P, 1.53 acres of proposed Filing 7 home lots and local roadway (Foothills Flash Court). A 10' CDOT Type R sump inlet is proposed at this location intercepting the entirety of the runoff. Pipe 24 (24" RCP,  $Q_5 = 10.5$  cfs and  $Q_{100} = 22.5$  cfs) conveys the intercepted runoff and that from Pipe 23, to a junction manhole with the large main from Mesa Top Drive and Foothills Flash Court. Pipe 25 (48" RCP  $Q_5 = 53.8$  cfs and  $Q_{100} = 126.1$  cfs) conveys the combined runoff from this manhole south within the open space/drainage tract and into the proposed full spectrum detention & storm water quality facility (Pond A/Design Point 19). A concrete impact structure and appropriately sized forebay will be installed at the terminus of Pipe 25 and entry point into the pond (See UD-BMP for forebay sizing). In the event of inlet failure, the emergency overflow path is to overtop the curb/walk to the south and drain into the open space/drainage tract and ultimately to Pond A/Design Point 19.

**DESIGN POINT 19 – FULL SPECTRUM DETENTION AND STORM WATER QUALITY FACILITY 'A'** ( $Q_5 = 59.1$  cfs,  $Q_{100} = 137.8$  cfs) is the overall developed runoff into the proposed Detention/Storm Water Quality Facility Pond 'A', including Basins U and R. Basin R is 1.64 acres of adjacent home lots that drain directly into Basin U (Pond 'A') due to the walk-out conditions of the lots. Basin U is 1.28 acres of the detention facility and surrounding slope area. This facility is a Private Full Spectrum Extended Detention Basin per the El Paso County & City of Colorado Springs and Mile High Flood District (MHFD), formally Urban Drainage Flood Control District, drainage criteria. The proposed facility was sized utilizing two excel workbooks from MHFD, UD-BMP version 3.05 and UD-Detention version 4.04. The composite impervious value was determined using Site-Level Low Impact Development (LID) Design Effective Impervious Calculator (IRF Form) located in the Appendix of this report. Also, an exhibit of the tributary area to the pond and the assumed impervious/pervious types is included in the Appendix.

A total of 38.29 acres of Forest Lakes land is tributary to this facility at a calculated imperviousness of 43.2%. The required EURV (Excess Urban Runoff Volume) is 1.753 acre-feet and the proposed top of outlet box at an elevation of 7114.40 (micropool w.s.e./start of SWQ = 7108.00) provides a EURV of 1.77 acre-feet. A concrete forebay structures (18" tall walls w/ 8.5" notch) will be installed at the pipe entry point into the proposed detention/water quality facility. A 7' wide low flow concrete trickle channel will be installed from the proposed forebay at Pipe 25 to the proposed pond outlet box at a 0.76% minimum

slope. The 48" Pipe 25 requires a minimum forebay volume of 0.018 acre-feet per the UD-BMP spreadsheet.

An 8' wide outlet box (4' deep opening) is proposed with a top of box at 7114.40 elevation. For a Full Spectrum facility, the outlet box orifice hole within the front plate is to drain the EURV in less than 72 hours. Per the UD-Detention version 3.07 spreadsheet from Mile High Flood District a total of (3) orifice holes are to be installed in the front plate of the outlet box with the bottom orifice hole of 2" wide x 1" high, and middle orifice of 3" wide x 2" high, and upper orifice of 3" wide x 2" high. A 2.5' deep concrete bottom micropool is to be installed within the wing walls of the outlet structure, with a surface area of 270 square feet. An initial surcharge depth of 4" will be provided within the micropool outlet structure. A removable trash screen of 12" in width will be placed in front of the orifice plate to help prevent the orifice holes from clogging. A 30" RCP outlet pipe (Pipe 26) will convey the detained release ( $Q_5 = 4.4$  cfs,  $Q_{100} = 48.5$  cfs, 100-yr water surface elevation of 7116.94, MH-Detention) to the existing Beaver Creek corridor located directly south and east of Filing 7. Impact structure/energy dissipation will be installed at the end of this 30" outfall pipe and just outside of the Preble's Jumping Mouse/no disturbance limits. A Bentley Flowmaster analysis is included in the appendix showing a non-erosive velocity at or less than 5 ft/sec downstream of the concrete impact structure along the native ground and drainage pattern. For conservative purposes, n coefficients between 0.03 to 0.05 were used in the cross sections downstream of the pipe outfall (Pipe 26) and have a velocity in the section less than 5 ft/sec (non-erosive). Therefore, additional downstream protection is not needed. This facility restricts the release to pre-development (historic levels) per the UD-Detention spreadsheet and is a portion of the direct comparison to Existing Conditions Design Point 4 ( $Q_5 = 44.3$  cfs and  $Q_{100} = 280.0$  cfs).

A 36' length riprap emergency spillway located at elevation 7117.00 will pass the entire incoming 100-year storm event at a flood depth of 0.98' in case of complete outlet box and pipe failure. Per the Drainage Criteria Manual (DCM), the top of the pond berm shall be minimum 2.0' higher than the flood depth water surface elevation. The proposed 12' wide top of berm elevation is at 7120.00. This emergency spillway will only be utilized in the case of a complete outlet box failure, and will drain directly into the wetlands, open space, and Beaver Creek corridor. A 15' wide maintenance access road at 12% max. grade will be installed to the bottom of the facility as per the DCM.



This facility adequately treats all 38.29 acres of Forest Lakes Filing 7 developed flows for storm water quality and detains the release to below historic rates. Per the Code of Colorado Regulations 4.2.5.1 a Jurisdictional Size Dam height is measured, either from the invert of the outlet pipe at the longitudinal centerline of the embankment (spillway elevation = 7117.00 & 30" invert at centerline of dam is 7107.37, 9.63') or the spillway elevation compared to the existing ground at the centerline (spillway elevation = 7117.00 & existing ground 7110.00, 7.0'). A dam height of 10' or below is not considered a 'Jurisdictional' facility with the State of Colorado. Therefore, this is a non-jurisdictional size dam and additional documentation/coordination with the State Engineer, beyond the typical non-jurisdictional form, is not required for the proposed facility. Maintenance and ownership of the Private detention/water quality facility and the entire proposed storm sewer is by the Forest Lakes Metropolitan District. An El Paso County Detention Pond Maintenance Agreement will be required indicating these Facilities to be ultimately owned and maintained by the Metro District.

**DESIGN POINT 20 ( $Q_5 = 0.9$  cfs and  $Q_{100} = 42.9$  cfs)** is the pipe outfall location for Pond 'A' as previously described in DP-19. Two Flowmaster Cross Sections (26A & 26B) are included in the Appendix for this area to show non-erosive velocities at the end of the concrete impact structure and downstream within the native ground Preble's Jumping Mouse/no disturbance limits. The use of a concrete impact structure and 18' end width of the concrete bottom ensures non-erosive velocities and shear stresses at the outfall of the proposed Pond 'A'.

**DESIGN POINT 21 ( $Q_5 = 7.7$  cfs and  $Q_{100} = 51.9$  cfs)** is the undeveloped runoff from Basins OS-1A & S-1 located north-west of the proposed Filing 7 limits. Basin OS-1A is 23.26 acres of the off-site, westerly adjacent US National Forest land that sheet flows to the east onto the overall Forest Lakes Boundary. Basin S-1 is 2.13 acres of Filing 6 & Filing 7 open space, undisturbed land that drains east and into the proposed interception swale and inlet system. As there are proposed lots backing into the native ground slope and natural drainage patterns of this large off-site basin (See OS-1 Existing Conditions), there is a need to intercept this runoff prior to draining through and into the home lots. A proposed riprap lined interception swale (2' bottom width, 1.5' depth, 4:1 side slope on downstream (east) side, 3:1 side slope on incoming slope (west) side, D50 = 12" rock) conveys the undeveloped runoff to the proposed CDOT

Type D (6' x 3', in-series and depressed) inlet at this design point. A Flowmaster cross section is included in the Appendix showing the drainage characteristics in the riprap interception swale. Figure 8-22 from the Urban Drainage and Flood Control District (MHFD) DCM Vol. 1 was used to verify stability of the Type M, 18" deep swale (See Appendix). In areas of longitudinal slope vs. flowrate that are not within the Type M, 18" depth range on Figure 8-22, 'partially grouted riprap' shall be installed. Partially grouted riprap has an advantage over ridge structures because it is flexible when under attached by water, it can remain functional even if some individual stones may be lost, and it can be repaired relatively easily. Partially grouted riprap consists of specifically sized rocks that are placed and grouted together, with the grout filling only 1/3 to 1/2 of the total void space. The voids of the riprap matrix are partially filled with a Portland cement based grout by hose or tremie, or by automated mechanical means. See Grading and Erosion Control Plans for areas of the riprap swale that are to be partially grouted riprap.

Pipe 27 (30" RCP) conveys the intercepted runoff to the south within the on-site open space and toward Design Point 22. A small portion of the 100-year event runoff (5.4 cfs) continues beyond this inlet within the riprap swale and to Design Point 22. The riprap lined interception swale, the CDOT area drain inlets, and storm pipe "bypass" system are all privately owned and maintained by the Forest Lakes Metropolitan District.

**DESIGN POINT 22 ( $Q_5 = 8.2$  cfs and  $Q_{100} = 60.6$  cfs)** is the undeveloped runoff from Basin OS-1B, Basin S-2, and the flow-by from DP-21. Basin OS-1B is 24.79 acres of the off-site, westerly adjacent US National Forest land that sheet flows to the east onto the overall Forest Lakes Boundary. Basin S-2 is 2.23 acres of Filing 7 open space, undisturbed land that drains east and into the proposed interception swale and inlet system. This location represents the highest flow rates within the proposed interception swale and per the Flowmaster Section in the Appendix, the 100-yr flow rate travels in the swale at 6.34 ft/sec and a flow depth of 16.7" (held within the 18" deep riprap swale). The same proposed riprap lined interception swale (2' bottom width, 1.5' depth, 4:1 side slope on downstream (east) side, 3:1 side slope on incoming slope (west) side, D50 = 12" rock) conveys the undeveloped runoff to the proposed CDOT Type D (6' x 3', in-series and depressed) inlet at this design point. Pipe 28 (36" RCP) conveys the intercepted runoff to an adjacent manhole combining with Pipe 27 from DP-21. Pipe 29 (48" RCP  $Q_5 = 15.9$  cfs and  $Q_{100} = 112.4$  cfs) is the outfall pipe from this manhole and conveys the combined runoff

south toward Design Point 23. A portion of the 100-year event runoff (14.0 cfs) continues beyond this inlet within the riprap swale and to Design Point 23. The riprap lined interception swale, the CDOT area drain inlets, and storm pipe “bypass” system are all privately owned and maintained by the Forest Lakes Metropolitan District. As this location represents the highest flow rate within the proposed interception swale, and the Flowmaster section shows it is being held within the swale, no other sections are needed at the downstream locations of the bypass system.

**DESIGN POINT 23 ( $Q_5 = 3.4$  cfs and  $Q_{100} = 36.5$  cfs)** is the undeveloped runoff from Basin OS-1C, Basin S-3 , and the flow-by from DP-22. Basin OS-1C is 9.91 acres of the off-site, westerly adjacent US National Forest land that sheet flows to the east onto the overall Forest Lakes Boundary. Basin S-3 is 1.14 acres of Filing 7 open space, undisturbed land that drains east and into the proposed interception swale and inlet system. The proposed riprap lined interception swale (2’ bottom width, 1.5’ depth, 4:1 side slope on downstream (east) side, 3:1 side slope on incoming slope (west) side, D50 = 12” rock) conveys the undeveloped runoff to the proposed CDOT Type D (6’ x 3’, in-series and depressed) inlet at this design point. Pipe 30 (30” RCP) conveys the intercepted runoff to an adjacent manhole combining with Pipe 29 from DP-22. Pipe 31 (48” RCP  $Q_5 = 19.2$  cfs and  $Q_{100} = 148.0$  cfs) is the outfall pipe from this manhole and conveys the combined runoff south toward Design Point 24. A small portion of the 100-year event runoff (0.7 cfs) continues beyond this inlet within the riprap swale and to Design Point 24. The riprap lined interception swale, the CDOT area drain inlets, and storm pipe “bypass” system are all privately owned and maintained by the Forest Lakes Metropolitan District.

**DESIGN POINT 24 ( $Q_5 = 2.3$  cfs and  $Q_{100} = 16.6$  cfs)** is the undeveloped runoff from Basin OS-1D, Basin S-4 , and the flow-by from DP-23. Basin OS-1D is 5.52 acres of the off-site, westerly adjacent US National Forest land that sheet flows to the east onto the overall Forest Lakes Boundary. Basin S-4 is 1.63 acres of Filing 7 open space, undisturbed land that drains east and into the proposed interception swale and inlet system. The proposed riprap lined interception swale (2’ bottom width, 1.5’ depth, 4:1 side slope on downstream (east) side, 3:1 side slope on incoming slope (west) side, D50 = 12” rock) conveys the undeveloped runoff to the proposed CDOT Type C (depressed) inlet at this design point. Pipe 32 (24” RCP) conveys the entirety of this runoff to an adjacent manhole combining with Pipe 31 from DP-23.

42" per CD's

Pipe 33 (48" RCP  $Q_5 = 21.2$  cfs and  $Q_{100} = 162.3$  cfs) is the outfall pipe from this manhole and conveys the combined runoff south toward Design Point 25.

**DESIGN POINT 25 ( $Q_5 = 2.1$  cfs and  $Q_{100} = 14.1$  cfs)** is the undeveloped runoff from Basin OS-1E and Basin S-5. Basin OS-1E is 2.76 acres of the off-site, westerly adjacent US National Forest land that sheet flows to the east onto the overall Forest Lakes Boundary. Basin S-5 is 2.92 acres of Filing 7 open space, undisturbed land that drains east and into the proposed interception swale and inlet system. The proposed riprap lined interception swale (2' bottom width, 1.5' depth, 4:1 side slope on downstream (east) side, 3:1 side slope on incoming slope (west) side, D50 = 12" rock) conveys the undeveloped runoff to the proposed CDOT Type C (depressed) inlet at this design point. Pipe 34 (24" RCP) conveys the entirety of this runoff to an adjacent manhole combining with Pipe 33 from DP-24. Pipe 35 (48" RCP  $Q_5 = 22.7$  cfs and  $Q_{100} = 172.4$  cfs) is the outfall pipe from this manhole and conveys the combined runoff south then east into Foothills Flash Court R.O.W. This 'Bypass Outfall' storm pipe continues east until a Tract C (between Lots 17 & 18) where it turns south and daylights at the southern edge of Filing 7, prior to the Preble's Jumping Mouse Limits. Impact structure/energy dissipation will be installed at the end of this 48" outfall pipe and just outside of the Preble's Jumping Mouse/no disturbance limits. A Bentley Flowmaster analysis is included in the appendix showing a non-erosive velocity at or less than 5 ft/sec downstream of the concrete impact structure along the native ground and drainage pattern. For conservative purposes, n coefficients between 0.03 to 0.05 were used in the cross sections downstream of the pipe outfall (Pipe 35) and have a velocity in the section less than 5 ft/sec (non-erosive). Therefore, additional downstream protection is not needed. This runoff is non-developed, historic stormwater and is therefore not required to be detained or treated for water quality. This represents a large portion of the comparison to the Existing Conditions Design Point 4 ( $Q_5 = 44.3$  cfs and  $Q_{100} = 280.0$  cfs).

**DESIGN POINT 26 ( $Q_5 = 22.7$  cfs and  $Q_{100} = 172.4$  cfs)** is the pipe outfall location for the 'Bypass System' as previously described in DP-25. Two Flowmaster Cross Sections (35A & 35B) are included in the Appendix for this area to show non-erosive velocities at the end of the concrete impact structure and downstream within the native ground Preble's Jumping Mouse/no disturbance limits. The use of a concrete impact structure and 70' end width of the concrete bottom ensures non-erosive velocities and shear stresses at the outfall of the undeveloped bypass system (Pipe 35).

**DESIGN POINT 27 ( $Q_5 = 3.0$  cfs and  $Q_{100} = 11.7$  cfs)** is the surface runoff into the native channel area and Preble's Jumping Mouse limits from Basins EX-D, OS-1F, and T. Basin OS-1F is 0.16 acres of the off-site, westerly adjacent US National Forest land that sheet flows to the east onto the overall Forest Lakes Boundary. Basin EX-D is 1.00 acres of undeveloped Beaver Creek adjacent land that drains northeast onto Basin T. Basin T is 2.69 acres of undeveloped open space area in the southwest corner of Filing 7, including rear yard drainage from Lots 18-22. This runoff will not concentrate and will 'sheet flow' into the native ground and non-erosion velocities along the southern boundary of Filing 7. Also, this Lot drainage in Basin T does not need to drain into Pond A as there is over 300' length of natural/open space prior to the floodplain limits of Beaver Creek. A PUD Modification was granted for such 'back yard' release and a copy is included in the Appendix of this report.

**DESIGN POINT 28 ( $Q_5 = 3.2$  cfs and  $Q_{100} = 7.5$  cfs)** is the runoff from Basin V, 1.61 acres of the rear yards and portions of Filing 7 home lots that drain directly south into the existing Beaver Creek drainage corridor. The majority of this basin is slope area and landscaped back yards with minimal impervious surfaces within (concrete, roof tops). This runoff will not concentrate and will 'sheet flow' into the native ground and non-erosion velocities. Also, this flow does not need to drain into a detention/water quality Pond as there is over 300' length of natural/open space prior to the floodplain limits of Beaver Creek. A PUD Modification was granted for such 'back yard' release and a copy is included in the Appendix of this report.

There are 4 locations of runoff release from the proposed Filing 7 development into the natural drainage conditions and Beaver Creek Channel corridor (Design Points 20, 26, 27, & 28). The combination of these four flow rates ( $Q_5 = 29.8$  cfs and  $Q_{100} = 234.5$  cfs) is to be directly compared to that from Existing Conditions Design Point 4 ( $Q_5 = 44.3$  cfs and  $Q_{100} = 280.0$  cfs). From this comparison, development of Forest Lakes Filing 7 does not hinder downstream native drainage channels or property and is designed in accordance with all applicable criteria.

## **STORMWATER QUALITY (FOUR STEP PROCESS)**

El Paso County requires the Four Step Process for receiving water protection that focuses on reducing runoff volumes, treating the water quality capture volume (WQCV), stabilizing drainage ways, and implementing long-term source controls. The Four Step Process pertains to management of smaller, frequently occurring storm events, as opposed to larger storms for which drainage and flood control infrastructure are sized. Implementation of these four steps to achieve stormwater permit requirements is required. The site adheres to this Four Step Process as follows:

1. Individual home roof downspouts will be directed onto pervious landscape areas. The additional grass buffer BMP provides the following: 1) Minimize directly connected impervious areas. 2) Provides initial pollutant and sediment removal before entering the storm system. Rear yard flows of those proposed lots adjacent to public streets will be directed over a grass buffer area (both landscaped and native grasses) to provide treatment of these small rear yard areas.
2. The proposed Pond A and existing Pond B provides Detention and Stormwater Quality Treatment for the entirety of the proposed development. The facilities in conjunction with Step 1 implementation above will address all required Water Quality Capture Volume and Slow Release Requirements.
3. The recipient of the drainage flows from the site is Beaver Creek, with an estimated 100-year storm runoff rate of 15,480 cfs to 16,190 cfs. This portion of the creek also contains Preble's Jumping Mouse habitat limits, 100-year FEMA floodplain, and jurisdictional wetlands. As such the downstream corridor is very well established and as the detained developed release rate is far less than historic, theoretically no additional erosion will occur.
4. Does not apply to this Residential subdivision as this step is to 'consider the need for Industrial and Commercial BMPs'. Temporary construction BMPs will be installed per the approved grading and erosion control plans.

**DRAINAGE AND BRIDGE FEES**

Forest Lakes Filings 7 is within the Beaver Creek Drainage Basin and is a total of 82.504 acres. Per the year 2021 El Paso County Drainage Fees, the Beaver Creek drainage fee is \$11,808 per impervious acre of development. Filing 7 consists of 24.533 acres of typical home lots, 6.263 acres of public right-of-way (roads), and 51.708 acres of open space/undeveloped area. Using Table 6-6 of the DCM, specifically 65% imperviousness for typical home lots, 100% imperviousness for pavement/right-of-way, and 0% imperviousness for open space/undeveloped area; an overall Filing 7 impervious area is calculated at 22.209 acres. Bridge Fees are not required for miscellaneous drainage basins.

**FILING 7 (22.209 Impervious acres)**

DRAINAGE FEE:

\$11,808/acre x 22.209 acres \$ 262,243.87

Based upon a review of the prior and current drainage fee off-sets / credits as well as drainage fees paid, with the El Paso County Engineering Review Manager in associated with the Filing No. 6 Final Drainage Report, the following summary of platting activity for this community was:

The current available drainage fee credit is \$172,159.77 per the approved fil. No. 6 Final Drainage Report. Using this amount to off-set the Filing No. 7 drainage fees and the 50% pond cost for the detention facility being built with Filing No. 7 (50% of \$145,000.00 = \$72,500.00) for a total of \$244,659.77 to be used to offset Filing No. 7 fees. Drainage Fees in the amount of \$17,584.10 will be required to be paid prior to plat recordation.

Forest Lakes Fees									
Project No. (plat no.)	Filing No.	on plat	date of plat	fees due in FDR	date of FDR	credits per FDR/agreement	Offset credit used	Paid in cash	credit remaining:
SF03036 (12407)	1 (no number)	zero	August 29, 2006	\$ 64,731.94	September 8, 2004	\$ 234,000.00	\$ 64,731.94	\$ -	\$ 169,268.06
SF06029 (12747)	3	zero	January 25, 2008	\$ 79,342.54	January 12, 2007		\$ 79,342.54	\$ -	\$ 89,925.52
SF1527 (13884)	2A	\$ 3,144.38	December 21, 2016	\$ 93,069.90	August 8, 2016		\$ 89,925.52	\$ 3,144.38	\$ -
SF1528 (14065)	2B	\$ 73,582.44	December 5, 2017	\$ 73,582.44	August 8, 2016		\$ -	\$ 73,582.44	\$ -
SF1817 (14263)	4	\$ 50,387.18	December 18, 2018	\$ 50,387.18	July 19, 2018		\$ -	\$ 50,387.18	\$ -
SF1519	fil 1 amended	na			October 20, 2015	\$ 271,388.50			\$ 271,388.50
SF1915	5	na	July 13, 2020	\$115,426.34	June 9, 2020	\$ 145,500.00	\$ 115,426.34		\$ 301,462.16
Sf2027	6	na	June 22, 2021	\$201,802.39	May 11, 2021	\$ 99,659.77	\$ 72,500.00	\$ -	\$ 172,159.77



## CONSTRUCTION COST OPINION

The following is a construction cost opinion for the public facilities, located within the public right-of-way and accepting runoff from the public roadways, and the private facilities, intercepting the off-site runoff and routing to the downstream natural channel:

### Public Drainage Facilities Non-reimbursable (FILING NO. 7)

ITEM	DESCRIPTION	QUANTITY	UNIT COST	COST
1.	5' Type-R Inlet	3 EACH	\$7,440/EA	\$ 22,320.00
2.	10' Type-R Inlet	5 EACH	\$8,136/EA	\$ 40,680.00
3.	15' D-10-R Inlet	8 EACH	\$11,005/EA	\$ 88,040.00
4.	18" RCP Storm Drain	318 LF	\$67/LF	\$ 21,306.00
5.	24" RCP Storm Drain	838 LF	\$81/LF	\$ 67,878.00
6.	30" RCP Storm Drain	413 LF	\$100/LF	\$ 41,300.00
7.	36" RCP Storm Drain	280 LF	\$124/LF	\$ 34,720.00
8.	42" RCP Storm Drain	122 LF	\$166/LF	\$ 20,252.00
9.	48" RCP Storm Drain	637 LF	\$202/LF	\$ 128,674.00
10.	Type II Storm MH	6 EACH	\$6,619/EA	\$ 39,714.00
11.	Type I Storm MH	10 EACH	\$12,034/EA	\$ 120,340.00
SUB-TOTAL				\$ 625,224.00
10% ENGINEERING				\$ 62,522.40
5% CONTINGENCIES				<u>\$ 31,261.20</u>
<b>TOTAL</b>				<b><u>\$ 719,007.60</u></b>

### Private Drainage Facilities Non-reimbursable (FILING NO. 7)

ITEM	DESCRIPTION	QUANTITY	UNIT COST	COST
1.	Geotextile (under riprap)	2,683 SY	\$6.20/SY	\$ 16,634.60
2.	Riprap (swale)	2,684 TONS	\$83/TON	\$ 222,772.00
3.	24" RCP Storm Drain	45 LF	\$81/LF	\$ 3,645.00
4.	30" RCP Storm Drain	510 LF	\$100/LF	\$ 51,000.00
5.	36" RCP Storm Drain	311 LF	\$124/LF	\$ 38,564.00
6.	42" RCP Storm Drain	742 LF	\$166/LF	\$ 123,172.00
7.	48" RCP Storm Drain	766 LF	\$202/LF	\$ 154,732.00
8.	CDOT Type C Inlets	2 EA	\$4,802/EA	\$ 9,604.00
9.	CDOT Type D Inlets	3 EA	\$5,932/EA	\$ 17,796.00
10.	Type II Storm MH	1 EA	\$6,619/EA	\$ 6,619.00
11.	Type I Storm MH	11 EA	\$12,034/EA	\$ 132,374.00
12.	Permanent Pond 'A'	5,350 CY	\$21/CY	\$ 112,350.00



SUB-TOTAL	\$ 889,262.60
10% ENGINEERING	\$ 88,926.26
5% CONTINGENCIES	\$ 44,463.13
<b>TOTAL</b>	<b><u>\$ 1,022,651.99</u></b>

**SUMMARY**

Developed runoff from the proposed Forest Lakes Filing 7 is proposed to outfall to one proposed private Full Spectrum Detention (EDB) and Storm Water Quality Facility (owned and maintained by the Forest Lakes Metropolitan District) prior to discharging to downstream facilities. The proposed Full Spectrum detention & water quality pond was sized using the current and applicable drainage criteria and provides release rates below existing allowable release rates. Therefore, the developed site runoff and proposed storm sewer facilities will not adversely affect the downstream facilities or surrounding developments.

PREPARED BY:

Matthew Larson  
Project Manager

mal/117570/FDR-FILING7.doc



## REFERENCES

1. City of Colorado Springs and El Paso County Drainage Criteria Manual Volume 1, May 2014.
2. Drainage Criteria Manual (Volume 3) latest revision April 2008, Urban Drainage and Flood Criteria District.
3. "Forest Lakes Master Development Drainage Plan," by Kiowa Engineering Corporation, revised April 11, 2002.
4. "Preliminary and Final Drainage Report Forest Lakes Subdivision Filing No. 1," by Kiowa Engineering Corporation, filed September 8, 2004.
5. "Drainage Report Amendment for Preliminary and Final Drainage Report Forest Lakes Subdivision Filing No. 1," by Classic Consulting Engineers & Surveyors, LLC, dated August 2015.
6. "Debris Flow/Mudflow Analysis Forest Lakes Subdivision (Phase 2) Lindbergh Road and W. Baptist Road El Paso County, Colorado," by CTL Thompson Inc., dated August 6, 2018.
7. "Master Development Drainage Plan Amendment and Preliminary Drainage Report for Forest Lakes (Filing 5, 6, 7)," by Classic Consulting Engineers & Surveyors LLC, approved April 1, 2019.
8. "Final Drainage Report for Forest Lakes Filing 5," by Classic Consulting Engineers & Surveyors, LLC, approved June 9, 2020.

## REFERENCES

1. City of Colorado Springs and El Paso County Drainage Criteria Manual Volume 1, May 2014.
2. Drainage Criteria Manual (Volume 3) latest revision April 2008, Urban Drainage and Flood Criteria District.
3. "Forest Lakes Master Development Drainage Plan," by Kiowa Engineering Corporation, revised April 11, 2002.
4. "Preliminary and Final Drainage Report Forest Lakes Subdivision Filing No. 1," by Kiowa Engineering Corporation, filed September 8, 2004.
5. "Drainage Report Amendment for Preliminary and Final Drainage Report Forest Lakes Subdivision Filing No. 1," by Classic Consulting Engineers & Surveyors, LLC, dated August 2015.
6. "Debris Flow/Mudflow Analysis Forest Lakes Subdivision (Phase 2) Lindbergh Road and W. Baptist Road El Paso County, Colorado," by CTL Thompson Inc., dated August 6, 2018.
7. "Master Development Drainage Plan Amendment and Preliminary Drainage Report for Forest Lakes (Filing 5, 6, 7)," by Classic Consulting Engineers & Surveyors LLC, approved April 1, 2019.
8. "Final Drainage Report for Forest Lakes Filing 5," by Classic Consulting Engineers & Surveyors, LLC, approved June 9, 2020.

## APPENDIX

Has this deviation been approved by EPC? If so, please provide additional documentation.

## FOREST LAKES FILINGS 5, 6 and 7

### JUSTIFICATION FOR PUD MODIFICATIONS: Back Yard Drainage – Direct Release

Chapter 4.2.6.F.2.g of the Land Development Code (LDC) allows for a PUD modification of a general development standard in the LDC or criteria of the Engineering Criteria Manual (ECM), provided at least one of the benefits identified in Chapter 4.2.6.F.2.h are met. Section 5.8 of the ECM establishes an additional mechanism whereby an engineering design standard can be modified provided the limits of consideration in ECM Section 5.8.6 are met and the modifications meets the criteria for approval in ECM Section 5.8.7.

#### Nature of Request:

Section of LDC/ECM from which modification is sought:

ECM Section 1.7.2 (APPENDIX I)

Specific Criteria from which modification is sought:

Water Quality Capture Volume Requirements.

Proposed nature and extent of modification:

Allow for direct release across grass buffer (or equivalent) for back yards of proposed single-family subdivision lots.

#### ECM Section 5.8.6: Limits of Consideration:

The ECM Administrator may only consider a project-specific modification to an existing standard when one of the following conditions is met:

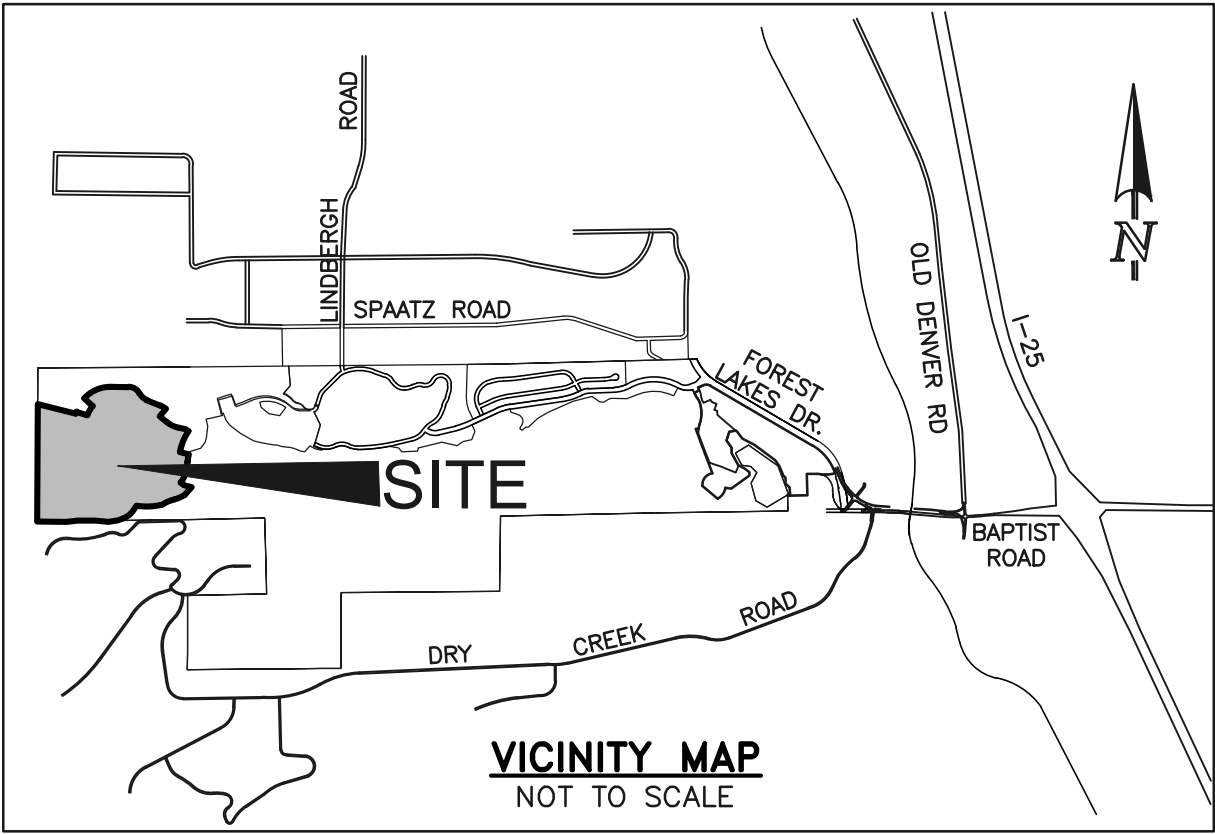
- The ECM standard is inapplicable to a particular situation.  
N/A
- Topography, right-of-way, or other geographical conditions or impediments impose an undue economic hardship on the applicant, and an equivalent alternative that can accomplish the same design objective is available and does not compromise public safety or accessibility.  
There is significant topography on this site and the proposed home lots are 'walk-out' lot conditions along natural open space and drainage corridors that contain Preble's Jumping Mouse Habitat and FEMA 100-year floodplain limits. There is limited ability to capture the drainage from the back yards but all roof drains will be routed to front yard and the street eventually to a permanent downstream water quality facility. All major imperviousness (roads, driveways, and rooftops) are all treated by a downstream full spectrum detention and water quality facility. There is a 300'+ buffer between the property line (end of back yards) and the waters of the State of Colorado; and other than a small patio, no additional anticipated imperviousness within the direct release back yard drainage basins.
- A change to a standard is required to address a specific design or construction problem, and if not modified, the standard will impose an undue hardship on the applicant with little or no material benefit to the public.  
Additional permanent water quality facilities would be required to capture all drainage from all of the back yards. As there is limited imperviousness, this runoff should not need detention nor water quality. Therefore, additional facilities to install and maintain would impose unnecessary hardship on the developer and Forest Lakes Metropolitan District.

#### ECM Section 5.8.7: Criteria for Approval

No modification shall be approved unless it is demonstrated that:

**VICINITY MAP**

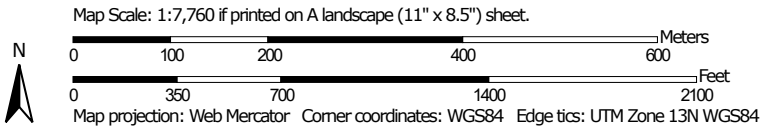
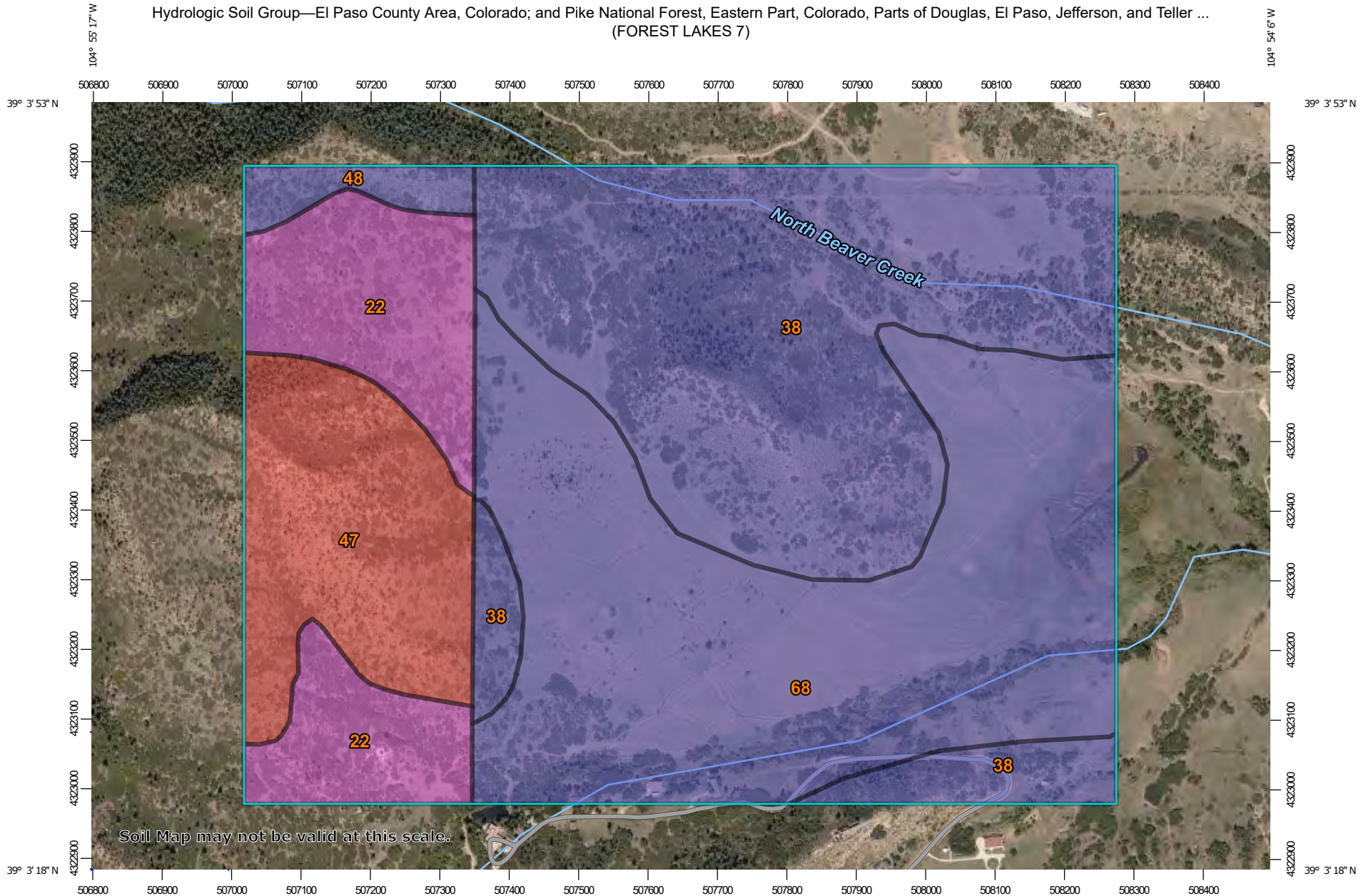




**SOILS MAP (S.C.S. SURVEY)**



Hydrologic Soil Group—El Paso County Area, Colorado; and Pike National Forest, Eastern Part, Colorado, Parts of Douglas, El Paso, Jefferson, and Teller ...  
(FOREST LAKES 7)



## MAP LEGEND

### Area of Interest (AOI)









 Area of Interest (AOI)

### Soils

#### Soil Rating Polygons





 A  
 A/D  
 B  
 B/D  
 C  
 C/D  
 D  
 Not rated or not available

#### Soil Rating Lines


 A  
 A/D  
 B  
 B/D  
 C  
 C/D  
 D  
 Not rated or not available

#### Soil Rating Points






 A  
 A/D  
 B  
 B/D

 C  
 C/D  
 D  
 Not rated or not available


### Water Features

 Streams and Canals

### Transportation

 Rails  
 Interstate Highways  
 US Routes  
 Major Roads  
 Local Roads

### Background

 Aerial Photography

## MAP INFORMATION

The soil surveys that comprise your AOI were mapped at 1:24,000.

Warning: Soil Map may not be valid at this scale.

Enlargement of maps beyond the scale of mapping can cause misunderstanding of the detail of mapping and accuracy of soil line placement. The maps do not show the small areas of contrasting soils that could have been shown at a more detailed scale.

Please rely on the bar scale on each map sheet for map measurements.

Source of Map: Natural Resources Conservation Service  
 Web Soil Survey URL:  
 Coordinate System: Web Mercator (EPSG:3857)

Maps from the Web Soil Survey are based on the Web Mercator projection, which preserves direction and shape but distorts distance and area. A projection that preserves area, such as the Albers equal-area conic projection, should be used if more accurate calculations of distance or area are required.

This product is generated from the USDA-NRCS certified data as of the version date(s) listed below.

Soil Survey Area: El Paso County Area, Colorado  
 Survey Area Data: Version 19, Aug 31, 2021

Soil Survey Area: Pike National Forest, Eastern Part, Colorado, Parts of Douglas, El Paso, Jefferson, and Teller Counties  
 Survey Area Data: Version 8, Aug 31, 2021

Your area of interest (AOI) includes more than one soil survey area. These survey areas may have been mapped at different scales, with a different land use in mind, at different times, or at different levels of detail. This may result in map unit symbols, soil properties, and interpretations that do not completely agree across soil survey area boundaries.

Soil map units are labeled (as space allows) for map scales 1:50,000 or larger.

Date(s) aerial images were photographed: Aug 19, 2018—Sep 23, 2018

## MAP LEGEND

## MAP INFORMATION

The orthophoto or other base map on which the soil lines were compiled and digitized probably differs from the background imagery displayed on these maps. As a result, some minor shifting of map unit boundaries may be evident.

## Hydrologic Soil Group

Map unit symbol	Map unit name	Rating	Acres in AOI	Percent of AOI
38	Jarre-Tecolote complex, 8 to 65 percent slopes	B	105.1	36.8%
68	Peyton-Pring complex, 3 to 8 percent slopes	B	105.4	36.9%
<b>Subtotals for Soil Survey Area</b>			<b>210.4</b>	<b>73.7%</b>
<b>Totals for Area of Interest</b>			<b>285.7</b>	<b>100.0%</b>

Map unit symbol	Map unit name	Rating	Acres in AOI	Percent of AOI
22	Kassler very gravelly coarse sandy loam, 5 to 35 percent slopes	A	35.1	12.3%
47	Sphinx, warm-Rock outcrop complex, 15 to 80 percent slopes	D	34.9	12.2%
48	Tecolote very gravelly sandy loam, 15 to 40 percent slopes, very stony	B	5.2	1.8%
<b>Subtotals for Soil Survey Area</b>			<b>75.2</b>	<b>26.3%</b>
<b>Totals for Area of Interest</b>			<b>285.7</b>	<b>100.0%</b>

## Description

Hydrologic soil groups are based on estimates of runoff potential. Soils are assigned to one of four groups according to the rate of water infiltration when the soils are not protected by vegetation, are thoroughly wet, and receive precipitation from long-duration storms.

The soils in the United States are assigned to four groups (A, B, C, and D) and three dual classes (A/D, B/D, and C/D). The groups are defined as follows:

Group A. Soils having a high infiltration rate (low runoff potential) when thoroughly wet. These consist mainly of deep, well drained to excessively drained sands or gravelly sands. These soils have a high rate of water transmission.

Group B. Soils having a moderate infiltration rate when thoroughly wet. These consist chiefly of moderately deep or deep, moderately well drained or well drained soils that have moderately fine texture to moderately coarse texture. These soils have a moderate rate of water transmission.

Group C. Soils having a slow infiltration rate when thoroughly wet. These consist chiefly of soils having a layer that impedes the downward movement of water or soils of moderately fine texture or fine texture. These soils have a slow rate of water transmission.

Group D. Soils having a very slow infiltration rate (high runoff potential) when thoroughly wet. These consist chiefly of clays that have a high shrink-swell potential, soils that have a high water table, soils that have a claypan or clay layer at or near the surface, and soils that are shallow over nearly impervious material. These soils have a very slow rate of water transmission.

If a soil is assigned to a dual hydrologic group (A/D, B/D, or C/D), the first letter is for drained areas and the second is for undrained areas. Only the soils that in their natural condition are in group D are assigned to dual classes.

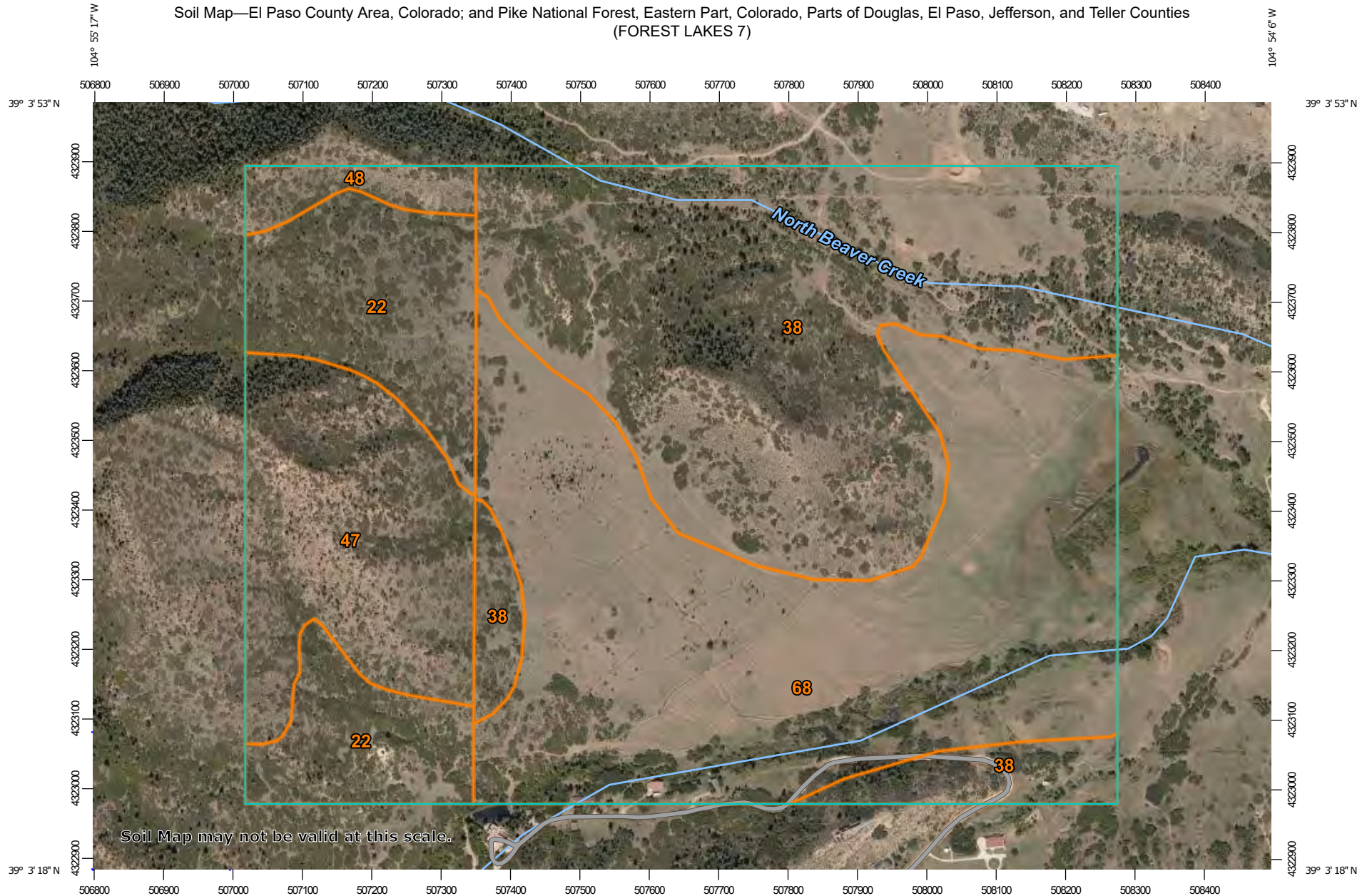
## Rating Options

*Aggregation Method:* Dominant Condition

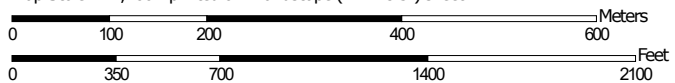
*Component Percent Cutoff:* None Specified

*Tie-break Rule:* Higher

Soil Map—El Paso County Area, Colorado; and Pike National Forest, Eastern Part, Colorado, Parts of Douglas, El Paso, Jefferson, and Teller Counties  
(FOREST LAKES 7)



Map Scale: 1:7,760 if printed on A landscape (11" x 8.5") sheet.



Map projection: Web Mercator Corner coordinates: WGS84 Edge tics: UTM Zone 13N WGS84




## MAP LEGEND

### Area of Interest (AOI)

 Area of Interest (AOI)

### Soils

 Soil Map Unit Polygons

 Soil Map Unit Lines

 Soil Map Unit Points

### Special Point Features



Blowout



Borrow Pit



Clay Spot



Closed Depression



Gravel Pit



Gravelly Spot



Landfill



Lava Flow



Marsh or swamp



Mine or Quarry



Miscellaneous Water



Perennial Water



Rock Outcrop



Saline Spot



Sandy Spot



Severely Eroded Spot



Sinkhole



Slide or Slip



Sodic Spot



Spoil Area



Stony Spot



Very Stony Spot



Wet Spot



Other



Special Line Features

### Water Features



Streams and Canals

### Transportation



Rails



Interstate Highways



US Routes



Major Roads



Local Roads

### Background



Aerial Photography

## MAP INFORMATION

The soil surveys that comprise your AOI were mapped at 1:24,000.

Warning: Soil Map may not be valid at this scale.

Enlargement of maps beyond the scale of mapping can cause misunderstanding of the detail of mapping and accuracy of soil line placement. The maps do not show the small areas of contrasting soils that could have been shown at a more detailed scale.

Please rely on the bar scale on each map sheet for map measurements.

Source of Map: Natural Resources Conservation Service

Web Soil Survey URL:

Coordinate System: Web Mercator (EPSG:3857)

Maps from the Web Soil Survey are based on the Web Mercator projection, which preserves direction and shape but distorts distance and area. A projection that preserves area, such as the Albers equal-area conic projection, should be used if more accurate calculations of distance or area are required.

This product is generated from the USDA-NRCS certified data as of the version date(s) listed below.

Soil Survey Area: El Paso County Area, Colorado

Survey Area Data: Version 19, Aug 31, 2021

Soil Survey Area: Pike National Forest, Eastern Part, Colorado,

Parts of Douglas, El Paso, Jefferson, and Teller Counties

Survey Area Data: Version 8, Aug 31, 2021

Your area of interest (AOI) includes more than one soil survey area. These survey areas may have been mapped at different scales, with a different land use in mind, at different times, or at different levels of detail. This may result in map unit symbols, soil properties, and interpretations that do not completely agree across soil survey area boundaries.

Soil map units are labeled (as space allows) for map scales 1:50,000 or larger.

Date(s) aerial images were photographed: Aug 19, 2018—Sep 23, 2018

## MAP LEGEND

## MAP INFORMATION

The orthophoto or other base map on which the soil lines were compiled and digitized probably differs from the background imagery displayed on these maps. As a result, some minor shifting of map unit boundaries may be evident.



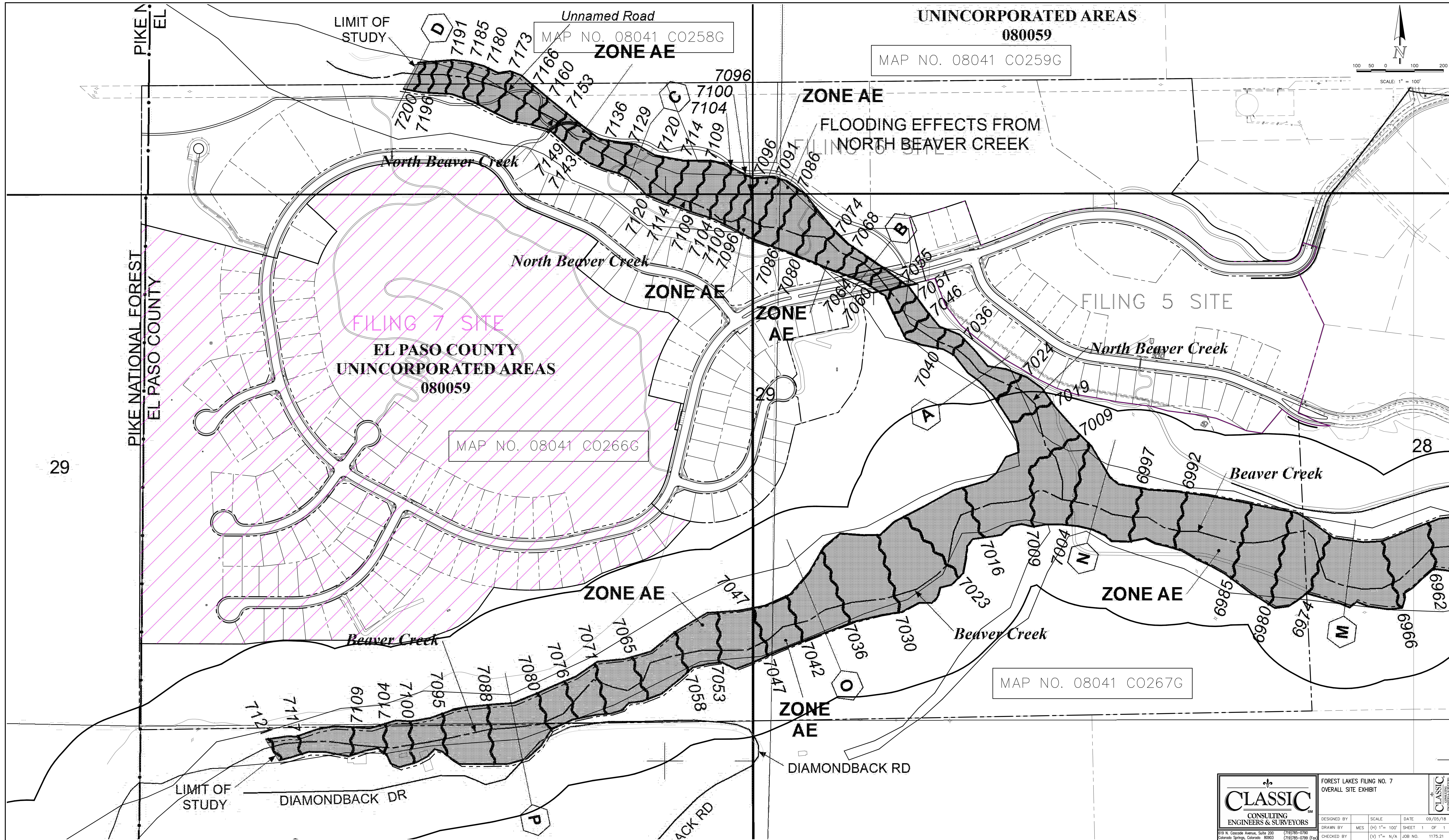
## Map Unit Legend

Map Unit Symbol	Map Unit Name	Acres in AOI	Percent of AOI
38	Jarre-Tecolote complex, 8 to 65 percent slopes	105.1	36.8%
68	Peyton-Pring complex, 3 to 8 percent slopes	105.4	36.9%
<b>Subtotals for Soil Survey Area</b>		<b>210.4</b>	<b>73.7%</b>
<b>Totals for Area of Interest</b>		<b>285.7</b>	<b>100.0%</b>

Map Unit Symbol	Map Unit Name	Acres in AOI	Percent of AOI
22	Kassler very gravelly coarse sandy loam, 5 to 35 percent slopes	35.1	12.3%
47	Sphinx, warm-Rock outcrop complex, 15 to 80 percent slopes	34.9	12.2%
48	Tecolote very gravelly sandy loam, 15 to 40 percent slopes, very stony	5.2	1.8%
<b>Subtotals for Soil Survey Area</b>		<b>75.2</b>	<b>26.3%</b>
<b>Totals for Area of Interest</b>		<b>285.7</b>	<b>100.0%</b>

**F.E.M.A. MAP**





		FOREST LAKES FILING NO. 7	
		OVERALL SITE EXHIBIT	
DESIGNED BY	SCALE	DATE	09/05/18
DRAWN BY	MES (H) 1" = 100'	SHEET	1 OF 1
CHECKED BY	(V) 1" = N/A	JOB NO.	1175.21

818 N. Cascade Avenue, Suite 203  
 Colorado Springs, Colorado 80903  
 (719) 785-0190  
 (719) 785-0199 (Fax)

N:\117521\DRAWINGS\ASSEMBLY\SYSTEMA - MAP 08041 CO258G.dwg, 10/9/2017, 12:28:58 PM, 1:108333

## EXISTING CONDITIONS CALCULATIONS

JOB NAME: FOREST LAKES FILING NO. 7  
 JOB NUMBER: 1175.70  
 DATE: 06/24/19  
 CALCULATED BY: MAL

**FINAL DRAINAGE REPORT ~ BASIN RUNOFF COEFFICIENT SUMMARY (EXISTING CONDITIONS)**

BASIN	TOTAL AREA (AC)	IMPERVIOUS AREA / STREETS			LOTS/LANDSCAPE/UNDEV. AREAS (NOT PAVEMENT)			WEIGHTED		WEIGHTED CA	
		AREA (AC)	C(5)	C(100)	AREA (AC)	C(5)	C(100)	C(5)	C(100)	CA(5)	CA(100)
OS-1	66.39	0.00	0.90	0.96	66.39	0.09	0.36	0.09	0.36	5.98	23.90
EX-A	3.98	0.70	0.90	0.96	3.28	0.20	0.43	0.32	0.52	1.29	2.08
EX-B	60.79	0.00	0.90	0.96	60.79	0.09	0.36	0.09	0.36	5.47	21.88
EX-C	44.59	0.00	0.90	0.96	44.59	0.09	0.36	0.09	0.36	4.01	16.05
EX-D	1.00	0.00	0.90	0.96	1.00	0.09	0.36	0.09	0.36	0.09	0.36

JOB NAME FOREST LAKES FILING NO. 7

JOB NUM 1175.70

DATE: 9/13/2020

CALC'D BY MAL

**FINAL DRAINAGE REPORT ~ BASIN RUNOFF SUMMARY (EXISTING CONDITIONS)**

BASIN	WEIGHTED		OVERLAND				STREET / CHANNEL FLOW				Tc	INTENSITY		TOTAL FLOWS	
	CA(5)	CA(100)	C(5)	Length (ft)	Height (ft)	Tc (min)	Length (ft)	Slope (%)	Velocity (fps)	Tc (min)	TOTAL (min)	I(5) (in/hr)	I(100) (in/hr)	Q(5) (cfs)	Q(100) (cfs)
OS-1	5.98	23.90	0.09	300	100	9.9	1720	18.0%	14.8	1.9	11.9	3.87	6.50	23.1	155.4
EX-A	1.29	2.08	0.45	100	3	8.2	260	5.0%	7.8	0.6	8.7	4.33	7.28	5.6	15.2
EX-B	5.47	21.88	0.09	300	40	13.4	2200	7.7%	9.7	3.8	17.2	3.31	5.56	18.1	121.8
EX-C	4.01	16.05	0.09	300	60	11.8	2370	7.2%	9.4	4.2	16.0	3.43	5.75	13.8	92.4
EX-D	0.09	0.36	0.09	120	30	6.9	200	7.0%	9.3	0.4	7.3	4.61	7.74	0.4	2.8

JOB NAME: FOREST LAKES FILING NO. 7  
 JOB NUMBER: 1175.70  
 DATE: 09/13/20  
 CALCULATED BY: MAL

**FINAL DRAINAGE REPORT ~ SURFACE ROUTING SUMMARY (EXISTING CONDITIONS)**

Design Point(s)	Contributing Basins	Equivalent CA(5)	Equivalent CA(100)	Maximum Tc	Intensity		Flow		Inlet Size
					I(5)	I(100)	Q(5)	Q(100)	
1	BASIN EX-A	1.29	2.08	8.7	4.33	7.28	5.6	15.2	Temp. Cul-de-sac (Filing 6)
2	BASIN OS-1	5.98	23.90	11.9	3.87	6.50	23.1	155.4	Offsite surface runoff
3	BASIN EX-D	0.09	0.36	7.3	4.61	7.74	0.4	2.8	Offsite surface runoff
4	BASIN EX-B + DP-1 + DP-2 +DP-3	12.82	48.23	15.6	3.46	5.81	44.3	280.0	Surface runoff to Beaver Creek
5	BASIN EX-C	4.01	16.05	16.0	3.43	5.75	13.8	92.4	Filing 6 Pond - To Beaver Creek

## DEVELOPED CONDITIONS CALCULATIONS



JOB NAME: FOREST LAKES FILING NO. 7  
 JOB NUMBER: 1175.70  
 DATE: 09/13/20  
 CALCULATED BY: MAL

**FINAL DRAINAGE REPORT ~ BASIN RUNOFF COEFFICIENT SUMMARY (DEVELOPED CONDITIONS)**

BASIN	TOTAL AREA (AC)	IMPERVIOUS AREA / STREETS			LOTS/LANDSCAPE/UNDEV. AREAS (NOT PAVEMENT)			WEIGHTED		WEIGHTED CA	
		AREA (AC)	C(5)	C(100)	AREA (AC)	C(5)	C(100)	C(5)	C(100)	CA(5)	CA(100)
A1	5.15	0.64	0.90	0.96	4.51	0.30	0.5	0.37	0.56	1.93	2.87
A2	1.01	0.13	0.90	0.96	0.88	0.32	0.5	0.39	0.56	0.40	0.56
B1	4.69	0.41	0.90	0.96	4.28	0.14	0.39	0.21	0.44	0.97	2.06
B2	3.16	0.17	0.90	0.96	2.99	0.25	0.46	0.28	0.49	0.90	1.54
C	6.00	0.33	0.90	0.96	5.67	0.20	0.43	0.24	0.46	1.43	2.75
D	3.27	0.36	0.90	0.96	2.91	0.20	0.43	0.28	0.49	0.91	1.60
E	5.09	0.32	0.90	0.96	4.77	0.09	0.36	0.14	0.40	0.72	2.02
F1	1.65	0.56	0.90	0.96	1.09	0.45	0.59	0.60	0.72	0.99	1.18
F2	0.91	0.30	0.90	0.96	0.61	0.45	0.59	0.60	0.71	0.54	0.65
G	2.50	0.35	0.90	0.96	2.15	0.35	0.53	0.43	0.59	1.07	1.48
H	3.11	0.62	0.90	0.96	2.49	0.31	0.5	0.43	0.59	1.33	1.84
J1	0.92	0.24	0.90	0.96	0.68	0.38	0.54	0.52	0.65	0.47	0.60
J2	1.65	0.14	0.90	0.96	1.51	0.35	0.53	0.40	0.57	0.65	0.93
K	2.30	0.56	0.90	0.96	1.74	0.31	0.5	0.45	0.61	1.04	1.41
L	1.20	0.42	0.90	0.96	0.78	0.45	0.59	0.61	0.72	0.73	0.86
M	1.19	0.17	0.90	0.96	1.02	0.45	0.59	0.51	0.64	0.61	0.77
M2	0.18	0.15	0.90	0.96	0.03	0.45	0.59	0.83	0.90	0.15	0.16
N	3.65	0.44	0.90	0.96	3.21	0.40	0.56	0.46	0.61	1.68	2.22
P	1.53	0.49	0.90	0.96	1.04	0.45	0.59	0.59	0.71	0.91	1.08

JOB NAME: FOREST LAKES FILING NO. 7  
 JOB NUMBER: 1175.70  
 DATE: 09/13/20  
 CALCULATED BY: MAL

**FINAL DRAINAGE REPORT ~ BASIN RUNOFF COEFFICIENT SUMMARY (DEVELOPED CONDITIONS)**

BASIN	TOTAL AREA (AC)	IMPERVIOUS AREA / STREETS			LOTS/LANDSCAPE/UNDEV. AREAS (NOT PAVEMENT)			WEIGHTED		WEIGHTED CA	
		AREA (AC)	C(5)	C(100)	AREA (AC)	C(5)	C(100)	C(5)	C(100)	CA(5)	CA(100)
Q	0.42	0.16	0.90	0.96	0.26	0.45	0.59	0.62	0.73	0.26	0.31
R	1.64	0.00	0.90	0.96	1.64	0.45	0.59	0.45	0.59	0.74	0.97
S-1	2.13	0.00	0.90	0.96	2.13	0.09	0.36	0.09	0.36	0.19	0.77
S-2	2.23	0.00	0.90	0.96	2.23	0.09	0.36	0.09	0.36	0.20	0.80
S-3	1.14	0.00	0.90	0.96	1.14	0.09	0.36	0.09	0.36	0.10	0.41
S-4	1.63	0.00	0.90	0.96	1.63	0.09	0.36	0.09	0.36	0.15	0.59
S-5	2.92	0.00	0.90	0.96	2.92	0.09	0.36	0.09	0.36	0.26	1.05
T	2.69	0.00	0.90	0.96	2.69	0.21	0.43	0.21	0.43	0.56	1.16
U	1.28	0.62	0.90	0.96	0.66	0.09	0.36	0.48	0.65	0.62	0.83
V	1.61	0.00	0.90	0.96	1.61	0.41	0.57	0.41	0.57	0.66	0.92
Z1	1.30	0.02	0.90	0.96	1.28	0.21	0.44	0.22	0.45	0.29	0.58
Z2	1.40	0.23	0.90	0.96	1.17	0.25	0.48	0.36	0.56	0.50	0.78
EX-D	1.00	0.00	0.90	0.96	1.00	0.09	0.36	0.09	0.36	0.09	0.36
OS-1A	23.26	0.00	0.90	0.96	23.26	0.09	0.36	0.09	0.36	2.09	8.37
OS-1B	24.79	0.00	0.90	0.96	24.79	0.09	0.36	0.09	0.36	2.23	8.92
OS-1C	9.91	0.00	0.90	0.96	9.91	0.09	0.36	0.09	0.36	0.89	3.57
OS-1D	5.52	0.00	0.90	0.96	5.52	0.09	0.36	0.09	0.36	0.50	1.99
OS-1E	2.76	0.00	0.90	0.96	2.76	0.09	0.36	0.09	0.36	0.25	0.99
OS-1F	0.16	0.00	0.90	0.96	0.16	0.09	0.36	0.09	0.36	0.01	0.06

JOB NAME FOREST LAKES FILING NO. 7

JOB NUM 1175.70

DATE: 9/13/2020

CALC'D BY MAL

**FINAL DRAINAGE REPORT ~ BASIN RUNOFF SUMMARY (DEVELOPED CONDITIONS)**

BASIN	WEIGHTED		OVERLAND				STREET / CHANNEL FLOW				Tc	INTENSITY		TOTAL FLOWS	
	CA(5)	CA(100)	C(5)	Length (ft)	Height (ft)	Tc (min)	Length (ft)	Slope (%)	Velocity (fps)	Tc (min)	TOTAL (min)	I(5) (in/hr)	I(100) (in/hr)	Q(5) (cfs)	Q(100) (cfs)
A1	1.93	2.87	0.45	100	2	9.3	870	7.1%	9.3	1.6	10.9	4.00	6.72	7.7	19.3
A2	0.40	0.56	0.45	100	2	9.3	160	5.0%	7.8	0.3	9.7	4.18	7.02	1.7	4.0
B1	0.97	2.06	0.45	100	2	9.3	220	3.2%	6.3	0.6	9.9	4.14	6.95	4.0	14.3
B2	0.90	1.54	0.45	100	6	6.5	225	6.2%	8.7	0.4	6.9	4.68	7.86	4.2	12.1
C	1.43	2.75	0.45	100	2	9.3	450	7.9%	9.8	0.8	10.1	4.11	6.91	5.9	19.0
D	0.91	1.60	0.45	100	2	9.3	290	7.9%	9.8	0.5	9.8	4.16	6.98	3.8	11.1
E	0.72	2.02	0.09	220	58	9.2	300	2.0%	4.9	1.0	10.2	4.10	6.88	2.9	13.9
F1	0.99	1.18	0.45	50	1	6.6	700	8.0%	9.9	1.2	7.8	4.51	7.57	4.5	8.9
F2	0.54	0.65	0.45	50	1	6.6	400	3.0%	6.1	1.1	7.7	4.52	7.59	2.5	4.9
G	1.07	1.48	0.45	100	2	9.3	470	7.6%	9.6	0.8	10.1	4.11	6.90	4.4	10.2
H	1.33	1.84	0.45	100	2	9.3	315	5.4%	8.1	0.6	10.0	4.13	6.94	5.5	12.8
J1	0.47	0.60	0.45	100	2	9.3	230	7.0%	9.3	0.4	9.8	4.17	7.00	2.0	4.2

JOB NAME FOREST LAKES FILING NO. 7

JOB NUM 1175.70

DATE: 9/13/2020

CALC'D BY MAL

**FINAL DRAINAGE REPORT ~ BASIN RUNOFF SUMMARY (DEVELOPED CONDITIONS)**

BASIN	WEIGHTED		OVERLAND				STREET / CHANNEL FLOW				Tc	INTENSITY		TOTAL FLOWS	
	CA(5)	CA(100)	C(5)	Length (ft)	Height (ft)	Tc (min)	Length (ft)	Slope (%)	Velocity (fps)	Tc (min)	TOTAL (min)	I(5) (in/hr)	I(100) (in/hr)	Q(5) (cfs)	Q(100) (cfs)
J2	0.65	0.93	0.45	100	2	9.3	90	2.0%	4.9	0.3	9.6	4.18	7.03	2.7	6.6
K	1.04	1.41	0.45	100	2	9.3	350	5.7%	8.4	0.7	10.0	4.12	6.92	4.3	9.7
L	0.73	0.86	0.45	50	1	6.6	460	5.0%	7.8	1.0	7.6	4.54	7.63	3.3	6.6
M	0.61	0.77	0.45	100	2	9.3	100	2.0%	4.9	0.3	9.7	4.18	7.02	2.6	5.4
M2	0.15	0.16	0.08	10	0.5	3.4	230	8.0%	9.9	0.4	5.0	5.17	8.68	0.8	1.4
N	1.68	2.22	0.45	100	2	9.3	450	3.3%	6.4	1.2	10.5	4.05	6.81	6.8	15.1
P	0.91	1.08	0.45	50	1	6.6	450	3.3%	6.4	1.2	7.8	4.51	7.56	4.1	8.2
Q	0.26	0.31	0.45	50	1	6.6	100	2.0%	4.9	0.3	6.9	4.68	7.85	1.2	2.4
R	0.74	0.97	0.45	50	10	3.1	155	16.0%	14.0	0.2	5.0	5.17	8.68	3.8	8.4
S-1	0.19	0.77	0.09	140	18	9.3	350	6.9%	9.2	0.6	9.9	4.14	6.95	0.8	5.3
S-2	0.20	0.80	0.09	260	38	12.1	280	5.7%	8.4	0.6	12.7	3.77	6.33	0.8	5.1
S-3	0.10	0.41	0.09	230	38	11.0	230	5.2%	8.0	0.5	11.4	3.93	6.59	0.4	2.7
S-4	0.15	0.59	0.09	125	18	8.5	300	10.9%	11.6	0.4	8.9	4.31	7.23	0.6	4.2

JOB NAME FOREST LAKES FILING NO. 7

JOB NUM 1175.70

DATE: 9/13/2020

CALC'D BY MAL

**FINAL DRAINAGE REPORT ~ BASIN RUNOFF SUMMARY (DEVELOPED CONDITIONS)**

BASIN	WEIGHTED		OVERLAND				STREET / CHANNEL FLOW				Tc	INTENSITY		TOTAL FLOWS	
	CA(5)	CA(100)	C(5)	Length (ft)	Height (ft)	Tc (min)	Length (ft)	Slope (%)	Velocity (fps)	Tc (min)	TOTAL (min)	I(5) (in/hr)	I(100) (in/hr)	Q(5) (cfs)	Q(100) (cfs)
S-5	0.26	1.05	0.09	200	74	7.8	410	9.3%	10.7	0.6	8.5	4.38	7.35	1.2	7.7
T	0.56	1.16	0.09	100	30	5.9	500	12.0%	12.1	0.7	6.6	4.75	7.97	2.7	9.2
U	0.62	0.83	0.09	35	9	3.7	200	0.5%	2.5	1.3	5.0	5.16	8.66	3.2	7.2
V	0.66	0.92	0.45	100	8	5.9	180	7.8%	9.8	0.3	6.2	4.84	8.13	3.2	7.5
Z1	0.29	0.58	0.09	25	4	3.7	450	11.0%	11.6	0.6	5.0	5.17	8.68	1.5	5.1
Z2	0.50	0.78	0.45	100	2	9.3	160	5.0%	7.8	0.3	9.7	4.18	7.02	2.1	5.5
EX-D	0.09	0.36	0.09	160	42	7.8	180	7.8%	9.8	0.3	8.2	4.44	7.45	0.4	2.7
OS-1A	2.09	8.37	0.09	300	40	13.4	2300	13.0%	12.6	3.0	16.5	3.38	5.67	7.1	47.5
OS-1B	2.23	8.92	0.09	300	40	13.4	2300	13.0%	12.6	3.0	16.5	3.38	5.67	7.5	50.6
OS-1C	0.89	3.57	0.09	300	40	13.4	730	13.0%	12.6	1.0	14.4	3.58	6.01	3.2	21.5
OS-1D	0.50	1.99	0.09	300	40	13.4	300	18.0%	14.8	0.3	13.8	3.65	6.13	1.8	12.2
OS-1E	0.25	0.99	0.09	300	100	9.9	160	29.0%	18.8	0.1	10.1	4.12	6.91	1.0	6.9
OS-1F	0.01	0.06	0.09	60	16	4.8	40	13.0%	12.6	0.1	5.0	5.17	8.68	0.1	0.5

JOB NAME: FOREST LAKES FILING NO. 7  
 JOB NUMBER: 1175.70  
 DATE: 09/13/20  
 CALCULATED BY: MAL

**FINAL DRAINAGE REPORT ~ SURFACE ROUTING SUMMARY (DEVELOPED CONDITIONS)**

Design Point(s)	Contributing Basins	Equivalent CA(5)	Equivalent CA(100)	Maximum Tc	Intensity		Flow		Inlet Size
					I(5)	I(100)	Q(5)	Q(100)	
1A	DP-8 + BASIN A1	2.33	3.43	10.9	4.00	6.72	9.3	23.1	15' Type R At-Grade
1B	BASIN B1 + FLOW-BY DP-1A	1.10	3.25	10.9	4.00	6.72	4.4	21.8	15' Type R At-Grade
2	BASIN B2 + FLOW-BY DP-1B	0.90	2.61	10.9	4.00	6.72	3.6	17.6	15' Type R At-Grade
3	BASIN C + FLOW-BY DP-2	1.43	3.42	11.7	3.90	6.55	5.6	22.4	15' Type R At-Grade
4	BASIN D + FLOW-BY DP-3	0.91	2.74	12.1	3.84	6.44	3.5	17.7	15' Type R At-Grade
5	BASIN E + FLOW-BY DP-4	0.71	2.73	12.1	3.84	6.44	2.7	17.6	15' Type R SUMP
6A	BASIN F1	0.99	1.18	7.8	4.51	7.57	4.5	8.9	5' Type R At-Grade
6B	BASIN F2 + FLOW BY DP-6A	0.94	1.34	7.8	4.51	7.57	4.2	10.1	10' Type R SUMP
7	BASIN Z1 + BASIN Z2	0.79	1.36	9.7	4.18	7.02	3.3	9.6	SURFACE FROM FIL. 6
8	BASIN A2	0.40	0.56	9.7	4.18	7.02	1.7	4.0	SURFACE FROM FIL. 6
9	DP-7 + BASIN G	1.85	2.84	10.1	4.11	6.90	7.6	19.6	15' Type R At-Grade
10	BASIN H + FLOW-BY DP-9	1.36	2.68	10.1	4.11	6.90	5.6	18.5	15' Type R At-Grade
11	BASIN J1 + FLOW-BY DP-10	0.48	1.33	10.1	4.11	6.90	2.0	9.2	10' Type R At-Grade
12	BASIN K	1.04	1.41	10.0	4.12	6.92	4.3	9.7	10' Type R At-Grade
13	BASIN J2 + FLOW-BY DP11 + FLOW-BY DP-12	0.68	1.65	10.1	4.11	6.90	2.8	11.4	10' Type R SUMP

JOB NAME: FOREST LAKES FILING NO. 7  
 JOB NUMBER: 1175.70  
 DATE: 09/13/20  
 CALCULATED BY: MAL

**FINAL DRAINAGE REPORT ~ SURFACE ROUTING SUMMARY (DEVELOPED CONDITIONS)**

Design Point(s)	Contributing Basins	Equivalent CA(5)	Equivalent CA(100)	Maximum Tc	Intensity		Flow		Inlet Size
					I(5)	I(100)	Q(5)	Q(100)	
14	BASIN L	0.73	0.86	7.6	4.54	7.63	3.3	6.6	10' Type R SUMP
15	BASIN M + BASIN M2	0.76	0.93	9.7	4.18	7.02	3.2	6.5	5' Type R Sump
16	BASIN Q	0.26	0.31	6.9	4.68	7.85	1.2	2.4	5' Type R Sump
17	BASIN N	1.68	2.22	10.5	4.05	6.81	6.8	15.1	15' Type R SUMP
18	BASIN P	0.91	1.08	7.8	4.51	7.56	4.1	8.2	10' Type R SUMP
19	BASIN U + BASIN R + PIPE 25	15.25	21.19	11.9	3.87	6.50	59.0	137.8	FSD/SWQ POND 'A'
20	POND A OUTFALL (PIPE 26)	1.14	7.46	11.9	3.87	6.50	4.4	48.5	SURFACE TO S.BEAVER
21	BASIN OS-1A + BASIN S-1	2.29	9.14	16.5	3.38	5.67	7.7	51.9	Type D (In Series & Depressed)
22	BASIN OS-1B + BASIN S-2 + FLOW-BY DP-21	2.43	10.67	16.5	3.38	5.67	8.2	60.6	Type D (In Series & Depressed)
23	BASIN OS-1C + BASIN S-3 + FLOW-BY DP-22	0.99	6.44	16.5	3.38	5.67	3.4	36.5	Type D (In Series & Depressed)
24	BASIN OS-1D + BASIN S-4 + FLOW-BY DP-23	0.64	2.70	13.8	3.65	6.13	2.3	16.6	Type C (Depressed)
25	BASIN OS-1E + BASIN S-5	0.51	2.04	10.1	4.12	6.91	2.1	14.1	Type C (Depressed)
26	BYPASS OUTFALL (PIPE 35)	6.87	31.00	17.2	3.31	5.56	22.7	172.4	SURFACE TO S.BEAVER
27	BASIN EX-D + BASIN OS-1F + BASIN T	0.67	1.57	8.2	4.44	7.45	3.0	11.7	SURFACE TO S.BEAVER
28	BASIN V	0.66	0.92	6.2	4.84	8.13	3.2	7.5	SURFACE TO S.BEAVER

JOB NAME: FOREST LAKES FILING NO. 7  
 JOB NUMBER: 1175.70  
 DATE: 09/13/20  
 CALCULATED BY: MAL

\* PIPES ARE LISTED AT MAXIMUM SIZE REQUIRED TO ACCOMMODATE Q100 FLOWS AT MINIMUM GRADE.  
 REFER TO INDIVIDUAL PIPE SHEETS FOR HYDRAULIC INFORMATION.

### FINAL DRAINAGE REPORT ~ PIPE ROUTING SUMMARY (DEVELOPED CONDITIONS)

Pipe Run	Contributing Basins	Equivalent CA(5)	Equivalent CA(100)	Maximum Tc	Intensity		Flow		Pipe Size*
					I(5)	I(100)	Q(5)	Q(100)	
1	DP-9 (Intercepted)	1.83	2.00	10.1	4.11	6.90	7.5	13.8	24"
2	DP-10 (Intercepted)	1.35	1.94	10.1	4.11	6.90	5.6	13.4	24"
3	PIPE 1 + PIPE 2	3.18	3.94	10.1	4.11	6.90	13.1	27.2	30"
4	DP-1A (Intercepted)	2.20	2.25	10.9	4.00	6.72	8.8	15.1	24"
5	DP-11 (Intercepted)	0.48	1.00	10.1	4.11	6.90	2.0	6.9	18"
6	PIPE 3 + PIPE 4 + PIPE 5	5.86	7.19	10.9	4.00	6.72	23.4	48.3	36"
7	DP-5	0.71	2.73	12.1	3.84	6.44	2.7	17.6	EX. 24"
8	DP-6B	0.94	1.34	7.8	4.51	7.57	4.2	10.1	EX. 18"
9	PIPE 39 + PIPE 7 + PIPE 8	4.60	8.87	12.6	3.78	6.35	17.4	56.3	EX. 30"
10	DP-12 (Intercepted)	1.02	1.03	10.0	4.12	6.92	4.2	7.1	18"
11	DP-13	0.68	1.65	10.1	4.11	6.90	2.8	11.4	18"
12	DP-14	0.73	0.86	7.6	4.54	7.63	3.3	6.6	18"
13	PIPE 10 + PIPE 11 + PIPE 12	2.43	3.54	10.1	4.11	6.90	10.0	24.4	30"



JOB NAME: FOREST LAKES FILING NO. 7  
 JOB NUMBER: 1175.70  
 DATE: 09/13/20  
 CALCULATED BY: MAL

\* PIPES ARE LISTED AT MAXIMUM SIZE REQUIRED TO ACCOMMODATE Q100 FLOWS AT MINIMUM GRADE.  
 REFER TO INDIVIDUAL PIPE SHEETS FOR HYDRAULIC INFORMATION.

### FINAL DRAINAGE REPORT ~ PIPE ROUTING SUMMARY (DEVELOPED CONDITIONS)

Pipe Run	Contributing Basins	Equivalent CA(5)	Equivalent CA(100)	Maximum Tc	Intensity		Flow		Pipe Size*
					I(5)	I(100)	Q(5)	Q(100)	
14	PIPE 6 + PIPE 13	8.28	10.73	10.9	4.00	6.72	33.1	72.1	42"
15	DP-1B (Intercepted)	1.10	2.17	10.9	4.00	6.72	4.4	14.6	24"
16	PIPE 14 + PIPE 15	9.38	12.91	10.9	4.00	6.72	37.5	86.7	42"
17	DP-2 (Intercepted)	0.90	1.95	10.9	4.00	6.72	3.6	13.1	24"
18	PIPE 16 + PIPE 17	10.28	14.86	11.1	3.98	6.68	40.9	99.2	42"
19	DP-16	0.26	0.31	6.9	4.68	7.85	1.2	2.4	18"
20	PIPE 18 + PIPE 19	10.54	15.16	11.2	3.96	6.64	41.7	100.7	42"
21	DP-15	0.76	0.93	9.7	4.18	7.02	3.2	6.5	18"
22	PIPE 20 + PIPE 21	11.31	16.09	11.2	3.96	6.64	44.7	106.9	48"
23	DP-17	1.68	2.22	10.5	4.05	6.81	6.8	15.1	24"
24	PIPE 23 + DP-18	2.59	3.30	10.5	4.05	6.81	10.5	22.5	24"
25	PIPE 22 + PIPE 24	13.89	19.39	11.9	3.87	6.50	53.8	126.1	48"
26	POND 'A' OUTFALL	1.14	7.46	11.9	3.87	6.50	4.4	48.5	30"

JOB NAME: FOREST LAKES FILING NO. 7  
 JOB NUMBER: 1175.70  
 DATE: 09/13/20  
 CALCULATED BY: MAL

\* PIPES ARE LISTED AT MAXIMUM SIZE REQUIRED TO ACCOMMODATE Q100 FLOWS AT MINIMUM GRADE.  
 REFER TO INDIVIDUAL PIPE SHEETS FOR HYDRAULIC INFORMATION.

### FINAL DRAINAGE REPORT ~ PIPE ROUTING SUMMARY (DEVELOPED CONDITIONS)

Pipe Run	Contributing Basins	Equivalent CA(5)	Equivalent CA(100)	Maximum Tc	Intensity		Flow		Pipe Size*
					I(5)	I(100)	Q(5)	Q(100)	
27	DP-21	2.29	9.14	16.5	3.38	5.67	7.7	51.9	30"
28	DP-22	2.43	10.67	16.5	3.38	5.67	8.2	60.6	36"
29	PIPE 27 + PIPE 28	4.72	19.81	16.5	3.38	5.67	15.9	112.4	48"
30	DP-23	0.99	6.44	16.5	3.38	5.67	3.4	36.5	30"
31	PIPE 29 + PIPE 30	5.71	26.25	16.7	3.36	5.64	19.2	148.0	48"
32	DP-24	0.64	2.70	13.8	3.65	6.13	2.3	16.6	24"
33	PIPE 31 + PIPE 32	6.35	28.96	16.9	3.34	5.60	21.2	162.3	48"
34	DP-25	0.51	2.04	10.1	4.12	6.91	2.1	14.1	24"
35	PIPE 33 + PIPE 34	6.87	31.00	17.2	3.31	5.56	22.7	172.4	48"
36	DP-3 (Intercepted)	1.44	2.28	11.7	3.90	6.55	5.6	14.9	24"
37	DP-4 (Intercepted)	0.91	2.03	12.1	3.84	6.44	3.5	13.1	24"
38	DP-6A (Intercepted)	0.60	0.49	7.8	4.51	7.57	2.7	3.7	18"
39	PIPE 36 + PIPE 37 + PIPE 38	2.95	4.80	12.1	3.84	6.44	11.3	30.9	30"

JOB NAME: FOREST LAKES FILING NO. 7  
 JOB NUMBER: 1175.70  
 DATE: 09/13/20  
 CALCULATED BY: MAL

**At-Grade Inlet - Flow Routing**

Design Point	TOTAL						INTERCEPTED				FLOW-BY			
	CA5	CA100	I5	I100	Q5	Q100	Q5	Q100	CA5	CA100	Q5	Q100	CA5	CA100
1A	2.33	3.43	4.00	6.72	9.3	23.1	8.8	15.1	2.20	2.25	0.5	8.0	0.13	1.19
1B	1.10	3.25	4.00	6.72	4.4	21.8	4.4	14.6	1.10	2.17	0.0	7.2	0.00	1.08
2	0.90	2.61	4.00	6.72	3.6	17.6	3.6	13.1	0.90	1.95	0.0	4.5	0.00	0.66
3	1.43	3.42	3.90	6.55	5.6	22.4	5.6	14.9	1.44	2.28	0.0	7.5	0.00	1.14
4	0.91	2.74	3.84	6.44	3.5	17.7	3.5	13.1	0.91	2.03	0.0	4.6	0.00	0.71
6A	0.99	1.18	4.51	7.57	4.5	8.9	2.7	3.7	0.60	0.49	1.8	5.2	0.40	0.69
9	1.85	2.84	4.11	6.90	7.6	19.6	7.5	13.8	1.83	2.00	0.1	5.8	0.03	0.84
10	1.36	2.68	4.11	6.90	5.6	18.5	5.6	13.4	1.35	1.94	0.0	5.1	0.00	0.74
11	0.48	1.33	4.11	6.90	2.0	9.2	2.0	6.9	0.48	1.00	0.0	2.3	0.00	0.33
12	1.04	1.41	4.12	6.92	4.3	9.7	4.2	7.1	1.02	1.03	0.1	2.6	0.02	0.38
21	2.29	9.14	3.38	5.67	7.7	51.9	7.7	46.5	2.28	8.19	0.0	5.4	0.00	0.95
22	2.43	10.67	3.38	5.67	8.2	60.6	8.2	46.6	2.43	8.21	0.0	14.0	0.00	2.46
23	0.99	6.44	3.38	5.67	3.4	36.5	3.4	35.8	1.00	6.31	0.0	0.7	0.00	0.13

JOB NAME:	<b>FOREST LAKES FILING NO. 7</b>
JOB NUMBER:	<b>1175.70</b>
DATE:	<b>09/13/20</b>
CALCULATED BY:	<b>MAL</b>

**FINAL DRAINAGE REPORT ~ PIPE TRAVEL TIMES**

PIPE RUN	STREET / CHANNEL FLOW				
	Pipe Diameter <i>(ft)</i>	Length <i>(ft)</i>	Slope <i>(%)</i>	Velocity <i>(fps)</i>	Tc <i>(min)</i>
3	2.5	355	6.0%	20.5	0.3
16	3.5	246	6.0%	25.7	0.2
18	3.5	105	1.0%	10.5	0.2
22	4.0	318	0.5%	8.1	0.7
29	4.0	330	4.0%	22.9	0.2
31	4.0	310	4.0%	22.9	0.2
33	4.5	450	4.0%	24.8	0.3
39	2.5	340	2.0%	11.8	0.5

Unresolved-Please provide deviation request for velocities larger than 18 fps on new pipes.

<b>INLET MANAGEMENT</b>
-------------------------

Worksheet Protected

INLET NAME	DP-1A INLET	DP-1B INLET	DP-2 INLET	DP-3 INLET	DP-4 INLET	DP-5 INLET
Site Type (Urban or Rural)	URBAN	URBAN	URBAN	URBAN	URBAN	URBAN
Inlet Application (Street or Area)	STREET	STREET	STREET	STREET	STREET	STREET
Hydraulic Condition	On Grade	On Grade	On Grade	On Grade	On Grade	In Sump
Inlet Type	CDOT Type R Curb Opening	CDOT Type R Curb Opening	CDOT Type R Curb Opening	CDOT Type R Curb Opening	CDOT Type R Curb Opening	CDOT Type R Curb Opening

## USER-DEFINED INPUT

User-Defined Design Flows						
Minor $Q_{Known}$ (cfs)	9.3	3.9	3.6	5.6	3.5	2.7
Major $Q_{Known}$ (cfs)	23.1	13.8	10.4	17.9	10.2	13.0

## Bypass (Carry-Over) Flow from Upstream

Receive Bypass Flow from:	No Bypass Flow Received	User-Defined	User-Defined	User-Defined	User-Defined	User-Defined
Minor Bypass Flow Received, $Q_b$ (cfs)	0.0	0.5	0.0	0.0	0.0	0.0
Major Bypass Flow Received, $Q_b$ (cfs)	0.0	8.0	7.2	4.5	7.5	4.6

## Watershed Characteristics

Subcatchment Area (acres)						
Percent Impervious						
NRCS Soil Type						

## Watershed Profile

Overland Slope (ft/ft)						
Overland Length (ft)						
Channel Slope (ft/ft)						
Channel Length (ft)						

## Minor Storm Rainfall Input

Design Storm Return Period, $T_r$ (years)						
One-Hour Precipitation, $P_1$ (inches)						

## Major Storm Rainfall Input

Design Storm Return Period, $T_r$ (years)						
One-Hour Precipitation, $P_1$ (inches)						

## CALCULATED OUTPUT

Minor Total Design Peak Flow, $Q$ (cfs)	9.3	4.4	3.6	5.6	3.5	2.7
Major Total Design Peak Flow, $Q$ (cfs)	23.1	21.8	17.6	22.4	17.7	17.6
Minor Flow Bypassed Downstream, $Q_b$ (cfs)	0.5	0.0	0.0	0.0	0.0	N/A
Major Flow Bypassed Downstream, $Q_b$ (cfs)	8.0	7.2	4.5	7.5	4.6	N/A

## Minor Storm (Calculated) Analysis of Flow Time

C	N/A	N/A	N/A	N/A	N/A	N/A
$C_s$	N/A	N/A	N/A	N/A	N/A	N/A
Overland Flow Velocity, $V_i$	N/A	N/A	N/A	N/A	N/A	N/A
Channel Flow Velocity, $V_t$	N/A	N/A	N/A	N/A	N/A	N/A
Overland Flow Time, $T_i$	N/A	N/A	N/A	N/A	N/A	N/A
Channel Travel Time, $T_t$	N/A	N/A	N/A	N/A	N/A	N/A
Calculated Time of Concentration, $T_c$	N/A	N/A	N/A	N/A	N/A	N/A
Regional $T_c$	N/A	N/A	N/A	N/A	N/A	N/A
Recommended $T_c$	N/A	N/A	N/A	N/A	N/A	N/A
$T_c$ selected by User	N/A	N/A	N/A	N/A	N/A	N/A
Design Rainfall Intensity, $I$	N/A	N/A	N/A	N/A	N/A	N/A
Calculated Local Peak Flow, $Q_p$	N/A	N/A	N/A	N/A	N/A	N/A

## Major Storm (Calculated) Analysis of Flow Time

C	N/A	N/A	N/A	N/A	N/A	N/A
$C_s$	N/A	N/A	N/A	N/A	N/A	N/A
Overland Flow Velocity, $V_i$	N/A	N/A	N/A	N/A	N/A	N/A
Channel Flow Velocity, $V_t$	N/A	N/A	N/A	N/A	N/A	N/A
Overland Flow Time, $T_i$	N/A	N/A	N/A	N/A	N/A	N/A
Channel Travel Time, $T_t$	N/A	N/A	N/A	N/A	N/A	N/A
Calculated Time of Concentration, $T_c$	N/A	N/A	N/A	N/A	N/A	N/A
Regional $T_c$	N/A	N/A	N/A	N/A	N/A	N/A
Recommended $T_c$	N/A	N/A	N/A	N/A	N/A	N/A
$T_c$ selected by User	N/A	N/A	N/A	N/A	N/A	N/A
Design Rainfall Intensity, $I$	N/A	N/A	N/A	N/A	N/A	N/A
Calculated Local Peak Flow, $Q_p$	N/A	N/A	N/A	N/A	N/A	N/A

<b>INLET MANAGEMENT</b>
-------------------------

Worksheet Protected

INLET NAME	DP-6B INLET	DP-6A INLET	DP-9 INLET	DP-10 INLET	DP-11 INLET	DP-12 INLET
Site Type (Urban or Rural)	URBAN	URBAN	URBAN	URBAN	URBAN	URBAN
Inlet Application (Street or Area)	STREET	STREET	STREET	STREET	STREET	STREET
Hydraulic Condition	In Sump	On Grade	On Grade	On Grade	On Grade	On Grade
Inlet Type	CDOT Type R Curb Opening	CDOT Type R Curb Opening	CDOT Type R Curb Opening	CDOT Type R Curb Opening	CDOT Type R Curb Opening	CDOT Type R Curb Opening

**USER-DEFINED INPUT****User-Defined Design Flows**

Minor $Q_{known}$ (cfs)	2.4	4.5	7.6	5.5	2.0	4.3
Major $Q_{known}$ (cfs)	4.9	8.9	19.6	12.7	4.1	9.7

**Bypass (Carry-Over) Flow from Upstream**

Receive Bypass Flow from:	User-Defined	No Bypass Flow Received	No Bypass Flow Received	User-Defined	No Bypass Flow Received	No Bypass Flow Received
Minor Bypass Flow Received, $Q_b$ (cfs)	1.8	0.0	0.1	0.1	0.0	0.0
Major Bypass Flow Received, $Q_b$ (cfs)	5.2	0.0	5.8	5.1	0.0	0.0

**Watershed Characteristics**

Subcatchment Area (acres)						
Percent Impervious						
NRCS Soil Type						

**Watershed Profile**

Overland Slope (ft/ft)						
Overland Length (ft)						
Channel Slope (ft/ft)						
Channel Length (ft)						

**Minor Storm Rainfall Input**

Design Storm Return Period, $T_r$ (years)						
One-Hour Precipitation, $P_1$ (inches)						

**Major Storm Rainfall Input**

Design Storm Return Period, $T_r$ (years)						
One-Hour Precipitation, $P_1$ (inches)						

**CALCULATED OUTPUT**

Minor Total Design Peak Flow, $Q$ (cfs)	4.2	4.5	7.6	5.6	2.0	4.3
Major Total Design Peak Flow, $Q$ (cfs)	10.1	8.9	19.6	18.5	9.2	9.7
Minor Flow Bypassed Downstream, $Q_b$ (cfs)	N/A	1.8	0.1	0.0	0.0	0.1
Major Flow Bypassed Downstream, $Q_b$ (cfs)	N/A	5.2	5.8	5.1	2.3	2.6

**Minor Storm (Calculated) Analysis of Flow T**

C	N/A	N/A	N/A	N/A	N/A	N/A
$C_s$	N/A	N/A	N/A	N/A	N/A	N/A
Overland Flow Velocity, $V_i$	N/A	N/A	N/A	N/A	N/A	N/A
Channel Flow Velocity, $V_t$	N/A	N/A	N/A	N/A	N/A	N/A
Overland Flow Time, $T_i$	N/A	N/A	N/A	N/A	N/A	N/A
Channel Travel Time, $T_t$	N/A	N/A	N/A	N/A	N/A	N/A
Calculated Time of Concentration, $T_c$	N/A	N/A	N/A	N/A	N/A	N/A
Regional $T_c$	N/A	N/A	N/A	N/A	N/A	N/A
Recommended $T_c$	N/A	N/A	N/A	N/A	N/A	N/A
$T_c$ selected by User	N/A	N/A	N/A	N/A	N/A	N/A
Design Rainfall Intensity, $I$	N/A	N/A	N/A	N/A	N/A	N/A
Calculated Local Peak Flow, $Q_p$	N/A	N/A	N/A	N/A	N/A	N/A

**Major Storm (Calculated) Analysis of Flow T**

C	N/A	N/A	N/A	N/A	N/A	N/A
$C_s$	N/A	N/A	N/A	N/A	N/A	N/A
Overland Flow Velocity, $V_i$	N/A	N/A	N/A	N/A	N/A	N/A
Channel Flow Velocity, $V_t$	N/A	N/A	N/A	N/A	N/A	N/A
Overland Flow Time, $T_i$	N/A	N/A	N/A	N/A	N/A	N/A
Channel Travel Time, $T_t$	N/A	N/A	N/A	N/A	N/A	N/A
Calculated Time of Concentration, $T_c$	N/A	N/A	N/A	N/A	N/A	N/A
Regional $T_c$	N/A	N/A	N/A	N/A	N/A	N/A
Recommended $T_c$	N/A	N/A	N/A	N/A	N/A	N/A
$T_c$ selected by User	N/A	N/A	N/A	N/A	N/A	N/A
Design Rainfall Intensity, $I$	N/A	N/A	N/A	N/A	N/A	N/A
Calculated Local Peak Flow, $Q_p$	N/A	N/A	N/A	N/A	N/A	N/A

**INLET MANAGEMENT**

Worksheet Protected

INLET NAME	DP-13 INLET	DP-14 INLET	DP-15 INLET	DP-16 INLET	DP-17 INLET	DP-18 INLET
Site Type (Urban or Rural)	URBAN	URBAN	URBAN	URBAN	URBAN	URBAN
Inlet Application (Street or Area)	STREET	STREET	STREET	STREET	STREET	STREET
Hydraulic Condition	In Sump	In Sump	In Sump	In Sump	In Sump	In Sump
Inlet Type	CDOT Type R Curb Opening	CDOT Type R Curb Opening	CDOT Type R Curb Opening	CDOT Type R Curb Opening	CDOT Type R Curb Opening	CDOT Type R Curb Opening

**USER-DEFINED INPUT****User-Defined Design Flows**

Minor $Q_{known}$ (cfs)	2.7	3.3	3.2	1.2	6.8	4.1
Major $Q_{known}$ (cfs)	6.5	6.6	6.5	2.4	15.1	8.2

**Bypass (Carry-Over) Flow from Upstream**

Receive Bypass Flow from:	User-Defined	No Bypass Flow Received	No Bypass Flow Received	No Bypass Flow Received	No Bypass Flow Received	No Bypass Flow Received
Minor Bypass Flow Received, $Q_b$ (cfs)	0.1	0.0	0.0	0.0	0.0	0.0
Major Bypass Flow Received, $Q_b$ (cfs)	4.9	0.0	0.0	0.0	0.0	0.0

**Watershed Characteristics**

Subcatchment Area (acres)						
Percent Impervious						
NRCS Soil Type						

**Watershed Profile**

Overland Slope (ft/ft)						
Overland Length (ft)						
Channel Slope (ft/ft)						
Channel Length (ft)						

**Minor Storm Rainfall Input**

Design Storm Return Period, $T_r$ (years)						
One-Hour Precipitation, $P_1$ (inches)						

**Major Storm Rainfall Input**

Design Storm Return Period, $T_r$ (years)						
One-Hour Precipitation, $P_1$ (inches)						

**CALCULATED OUTPUT**

Minor Total Design Peak Flow, $Q$ (cfs)	2.8	3.3	3.2	1.2	6.8	4.1
Major Total Design Peak Flow, $Q$ (cfs)	11.4	6.6	6.5	2.4	15.1	8.2
Minor Flow Bypassed Downstream, $Q_b$ (cfs)	N/A	N/A	N/A	N/A	N/A	N/A
Major Flow Bypassed Downstream, $Q_b$ (cfs)	N/A	N/A	N/A	N/A	N/A	N/A

**Minor Storm (Calculated) Analysis of Flow T**

C	N/A	N/A	N/A	N/A	N/A	N/A
$C_s$	N/A	N/A	N/A	N/A	N/A	N/A
Overland Flow Velocity, $V_i$	N/A	N/A	N/A	N/A	N/A	N/A
Channel Flow Velocity, $V_t$	N/A	N/A	N/A	N/A	N/A	N/A
Overland Flow Time, $T_i$	N/A	N/A	N/A	N/A	N/A	N/A
Channel Travel Time, $T_t$	N/A	N/A	N/A	N/A	N/A	N/A
Calculated Time of Concentration, $T_c$	N/A	N/A	N/A	N/A	N/A	N/A
Regional $T_c$	N/A	N/A	N/A	N/A	N/A	N/A
Recommended $T_c$	N/A	N/A	N/A	N/A	N/A	N/A
$T_c$ selected by User	N/A	N/A	N/A	N/A	N/A	N/A
Design Rainfall Intensity, $I$	N/A	N/A	N/A	N/A	N/A	N/A
Calculated Local Peak Flow, $Q_p$	N/A	N/A	N/A	N/A	N/A	N/A

**Major Storm (Calculated) Analysis of Flow T**

C	N/A	N/A	N/A	N/A	N/A	N/A
$C_s$	N/A	N/A	N/A	N/A	N/A	N/A
Overland Flow Velocity, $V_i$	N/A	N/A	N/A	N/A	N/A	N/A
Channel Flow Velocity, $V_t$	N/A	N/A	N/A	N/A	N/A	N/A
Overland Flow Time, $T_i$	N/A	N/A	N/A	N/A	N/A	N/A
Channel Travel Time, $T_t$	N/A	N/A	N/A	N/A	N/A	N/A
Calculated Time of Concentration, $T_c$	N/A	N/A	N/A	N/A	N/A	N/A
Regional $T_c$	N/A	N/A	N/A	N/A	N/A	N/A
Recommended $T_c$	N/A	N/A	N/A	N/A	N/A	N/A
$T_c$ selected by User	N/A	N/A	N/A	N/A	N/A	N/A
Design Rainfall Intensity, $I$	N/A	N/A	N/A	N/A	N/A	N/A
Calculated Local Peak Flow, $Q_p$	N/A	N/A	N/A	N/A	N/A	N/A

**INLET MANAGEMENT**

Worksheet Protected

INLET NAME	DP-21 INLET	DP-22 INLET	DP-23 INLET	DP-24 INLET	DP-25 INLET
Site Type (Urban or Rural)	RURAL	RURAL	RURAL	RURAL	RURAL
Inlet Application (Street or Area)	AREA	AREA	AREA	AREA	AREA
Hydraulic Condition	Swale	Swale	Swale	Swale	Swale
Inlet Type	CDOT Type D (In Series & Depressed)	CDOT Type D (In Series & Depressed)	CDOT Type D (In Series)	CDOT Type C (Depressed)	CDOT Type C (Depressed)

**USER-DEFINED INPUT**

<b>User-Defined Design Flows</b>					
Minor $Q_{known}$ (cfs)	7.7	8.2	3.4	2.3	2.1
Major $Q_{known}$ (cfs)	51.9	55.2	22.5	15.9	14.1
<b>Bypass (Carry-Over) Flow from Upstream</b>					
Receive Bypass Flow from:	No Bypass Flow Received	No Bypass Flow Received	No Bypass Flow Received	No Bypass Flow Received	No Bypass Flow Received
Minor Bypass Flow Received, $Q_b$ (cfs)	0.0	0.0	0.0	0.0	0.0
Major Bypass Flow Received, $Q_b$ (cfs)	0.0	5.4	14.0	0.7	0.0
<b>Watershed Characteristics</b>					
Subcatchment Area (acres)					
Percent Impervious					
NRCS Soil Type					
<b>Watershed Profile</b>					
Overland Slope (ft/ft)					
Overland Length (ft)					
Channel Slope (ft/ft)					
Channel Length (ft)					
<b>Minor Storm Rainfall Input</b>					
Design Storm Return Period, $T_r$ (years)					
One-Hour Precipitation, $P_1$ (inches)					
<b>Major Storm Rainfall Input</b>					
Design Storm Return Period, $T_r$ (years)					
One-Hour Precipitation, $P_1$ (inches)					

**CALCULATED OUTPUT**

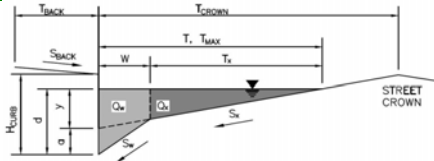
<b>Minor Total Design Peak Flow, Q (cfs)</b>	7.7	8.2	3.4	2.3	2.1
<b>Major Total Design Peak Flow, Q (cfs)</b>	51.9	60.6	36.5	16.6	14.1
Minor Flow Bypassed Downstream, $Q_b$ (cfs)	0.0	0.0	0.0	0.0	0.0
Major Flow Bypassed Downstream, $Q_b$ (cfs)	5.4	14.0	0.7	0.0	0.0
<b>Minor Storm (Calculated) Analysis of Flow T</b>					
C	N/A	N/A	N/A	N/A	N/A
$C_s$	N/A	N/A	N/A	N/A	N/A
Overland Flow Velocity, $V_i$	N/A	N/A	N/A	N/A	N/A
Channel Flow Velocity, $V_t$	N/A	N/A	N/A	N/A	N/A
Overland Flow Time, $T_i$	N/A	N/A	N/A	N/A	N/A
Channel Travel Time, $T_t$	N/A	N/A	N/A	N/A	N/A
Calculated Time of Concentration, $T_c$	N/A	N/A	N/A	N/A	N/A
Regional $T_c$	N/A	N/A	N/A	N/A	N/A
Recommended $T_c$	N/A	N/A	N/A	N/A	N/A
$T_c$ selected by User	N/A	N/A	N/A	N/A	N/A
Design Rainfall Intensity, I	N/A	N/A	N/A	N/A	N/A
Calculated Local Peak Flow, $Q_p$	N/A	N/A	N/A	N/A	N/A
<b>Major Storm (Calculated) Analysis of Flow T</b>					
C	N/A	N/A	N/A	N/A	N/A
$C_s$	N/A	N/A	N/A	N/A	N/A
Overland Flow Velocity, $V_i$	N/A	N/A	N/A	N/A	N/A
Channel Flow Velocity, $V_t$	N/A	N/A	N/A	N/A	N/A
Overland Flow Time, $T_i$	N/A	N/A	N/A	N/A	N/A
Channel Travel Time, $T_t$	N/A	N/A	N/A	N/A	N/A
Calculated Time of Concentration, $T_c$	N/A	N/A	N/A	N/A	N/A
Regional $T_c$	N/A	N/A	N/A	N/A	N/A
Recommended $T_c$	N/A	N/A	N/A	N/A	N/A
$T_c$ selected by User	N/A	N/A	N/A	N/A	N/A
Design Rainfall Intensity, I	N/A	N/A	N/A	N/A	N/A
Calculated Local Peak Flow, $Q_p$	N/A	N/A	N/A	N/A	N/A



**ALLOWABLE CAPACITY FOR ONE-HALF OF STREET (Minor & Major Storm)**

(Based on Regulated Criteria for Maximum Allowable Flow Depth and Spread)

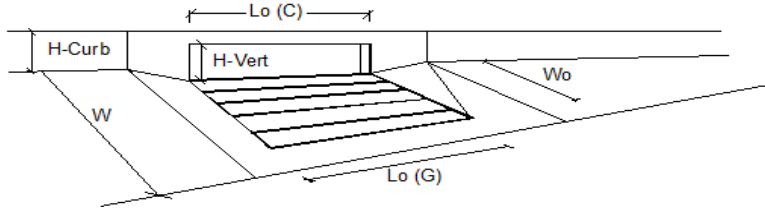
Project: \_\_\_\_\_ Enter Your Project Name Here  
 Inlet ID: \_\_\_\_\_ DP-1A INLET



Gutter Geometry (Enter data in the blue cells)					
Maximum Allowable Width for Spread Behind Curb	$T_{BACK} = 7.5$ ft				
Side Slope Behind Curb (leave blank for no conveyance credit behind curb)	$S_{BACK} = 0.020$ ft/ft				
Manning's Roughness Behind Curb (typically between 0.012 and 0.020)	$n_{BACK} = 0.013$				
Height of Curb at Gutter Flow Line	$H_{CURB} = 6.00$ inches				
Distance from Curb Face to Street Crown	$T_{CROWN} = 17.0$ ft				
Gutter Width	$W = 2.00$ ft				
Street Transverse Slope	$S_x = 0.020$ ft/ft				
Gutter Cross Slope (typically 2 inches over 24 inches or 0.083 ft/ft)	$S_w = 0.083$ ft/ft				
Street Longitudinal Slope - Enter 0 for sump condition	$S_0 = 0.040$ ft/ft				
Manning's Roughness for Street Section (typically between 0.012 and 0.020)	$n_{STREET} = 0.016$				
Max. Allowable Spread for Minor & Major Storm	<table border="1" style="display: inline-table; border-collapse: collapse;"> <tr> <th style="width: 50%;">Minor Storm</th> <th style="width: 50%;">Major Storm</th> </tr> <tr> <td><math>T_{MAX} = 17.0</math></td> <td><math>T_{MAX} = 17.0</math></td> </tr> </table> ft	Minor Storm	Major Storm	$T_{MAX} = 17.0$	$T_{MAX} = 17.0$
Minor Storm	Major Storm				
$T_{MAX} = 17.0$	$T_{MAX} = 17.0$				
Max. Allowable Depth at Gutter Flowline for Minor & Major Storm	<table border="1" style="display: inline-table; border-collapse: collapse;"> <tr> <th style="width: 50%;">Minor Storm</th> <th style="width: 50%;">Major Storm</th> </tr> <tr> <td><math>d_{MAX} = 5.1</math></td> <td><math>d_{MAX} = 7.8</math></td> </tr> </table> inches	Minor Storm	Major Storm	$d_{MAX} = 5.1$	$d_{MAX} = 7.8$
Minor Storm	Major Storm				
$d_{MAX} = 5.1$	$d_{MAX} = 7.8$				
Allow Flow Depth at Street Crown (leave blank for no)	<input type="checkbox"/> <input checked="" type="checkbox"/> check = yes				
<b>MINOR STORM Allowable Capacity is based on Depth Criterion</b>					
<b>MAJOR STORM Allowable Capacity is based on Depth Criterion</b>					
<b>Minor storm max. allowable capacity GOOD - greater than the design flow given on sheet 'Inlet Management'</b>					
<b>Major storm max. allowable capacity GOOD - greater than the design flow given on sheet 'Inlet Management'</b>					
$Q_{allow} =$	<table border="1" style="display: inline-table; border-collapse: collapse;"> <tr> <th style="width: 50%;">Minor Storm</th> <th style="width: 50%;">Major Storm</th> </tr> <tr> <td>15.9</td> <td>30.7</td> </tr> </table> cfs	Minor Storm	Major Storm	15.9	30.7
Minor Storm	Major Storm				
15.9	30.7				

## INLET ON A CONTINUOUS GRADE

Version 4.05 Released March 2017

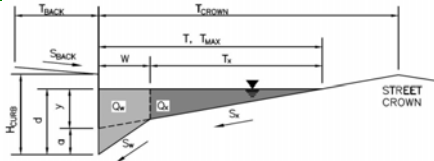


<b>Design Information (Input)</b>	MINOR	MAJOR	
Type of Inlet	CDOT Type R Curb Opening		
Local Depression (additional to continuous gutter depression 'a')	3.0	3.0	inches
Total Number of Units in the Inlet (Grate or Curb Opening)	1	1	
Length of a Single Unit Inlet (Grate or Curb Opening)	15.00	15.00	ft
Width of a Unit Grate (cannot be greater than W, Gutter Width)	N/A	N/A	ft
Clogging Factor for a Single Unit Grate (typical min. value = 0.5)	N/A	N/A	
Clogging Factor for a Single Unit Curb Opening (typical min. value = 0.1)	0.10	0.10	
<b>Street Hydraulics: OK - Q &lt; Allowable Street Capacity*</b>	MINOR	MAJOR	
Total Inlet Interception Capacity	8.8	15.1	cfs
Total Inlet Carry-Over Flow (flow bypassing inlet)	0.5	8.0	cfs
Capture Percentage = $Q_i/Q_o =$	95	65	%

**ALLOWABLE CAPACITY FOR ONE-HALF OF STREET (Minor & Major Storm)**

(Based on Regulated Criteria for Maximum Allowable Flow Depth and Spread)

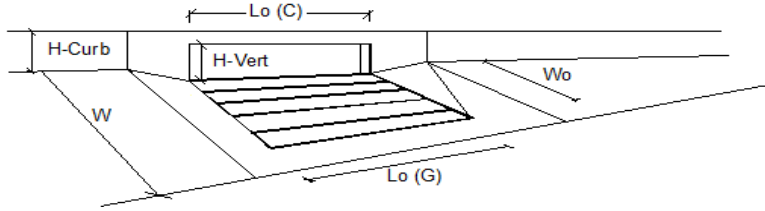
Project: \_\_\_\_\_ Enter Your Project Name Here  
 Inlet ID: \_\_\_\_\_ DP-1B INLET



Gutter Geometry (Enter data in the blue cells)					
Maximum Allowable Width for Spread Behind Curb	$T_{BACK} = 7.5$ ft				
Side Slope Behind Curb (leave blank for no conveyance credit behind curb)	$S_{BACK} = 0.020$ ft/ft				
Manning's Roughness Behind Curb (typically between 0.012 and 0.020)	$n_{BACK} = 0.013$				
Height of Curb at Gutter Flow Line	$H_{CURB} = 6.00$ inches				
Distance from Curb Face to Street Crown	$T_{CROWN} = 17.0$ ft				
Gutter Width	$W = 2.00$ ft				
Street Transverse Slope	$S_X = 0.020$ ft/ft				
Gutter Cross Slope (typically 2 inches over 24 inches or 0.083 ft/ft)	$S_W = 0.083$ ft/ft				
Street Longitudinal Slope - Enter 0 for sump condition	$S_O = 0.040$ ft/ft				
Manning's Roughness for Street Section (typically between 0.012 and 0.020)	$n_{STREET} = 0.016$				
Max. Allowable Spread for Minor & Major Storm	<table border="1" style="display: inline-table; border-collapse: collapse;"> <tr> <th style="width: 50%;">Minor Storm</th> <th style="width: 50%;">Major Storm</th> </tr> <tr> <td><math>T_{MAX} = 17.0</math></td> <td><math>T_{MAX} = 17.0</math></td> </tr> </table> ft	Minor Storm	Major Storm	$T_{MAX} = 17.0$	$T_{MAX} = 17.0$
Minor Storm	Major Storm				
$T_{MAX} = 17.0$	$T_{MAX} = 17.0$				
Max. Allowable Depth at Gutter Flowline for Minor & Major Storm	<table border="1" style="display: inline-table; border-collapse: collapse;"> <tr> <th style="width: 50%;">Minor Storm</th> <th style="width: 50%;">Major Storm</th> </tr> <tr> <td><math>d_{MAX} = 5.1</math></td> <td><math>d_{MAX} = 7.8</math></td> </tr> </table> inches	Minor Storm	Major Storm	$d_{MAX} = 5.1$	$d_{MAX} = 7.8$
Minor Storm	Major Storm				
$d_{MAX} = 5.1$	$d_{MAX} = 7.8$				
Allow Flow Depth at Street Crown (leave blank for no)	<table border="1" style="display: inline-table; border-collapse: collapse;"> <tr> <td style="width: 50%; text-align: center;"><input type="checkbox"/></td> <td style="width: 50%; text-align: center;"><input checked="" type="checkbox"/></td> </tr> </table> check = yes	<input type="checkbox"/>	<input checked="" type="checkbox"/>		
<input type="checkbox"/>	<input checked="" type="checkbox"/>				
<b>MINOR STORM Allowable Capacity is based on Depth Criterion</b>					
<b>MAJOR STORM Allowable Capacity is based on Depth Criterion</b>					
<b>Minor storm max. allowable capacity GOOD - greater than the design flow given on sheet 'Inlet Management'</b>					
<b>Major storm max. allowable capacity GOOD - greater than the design flow given on sheet 'Inlet Management'</b>					
$Q_{allow} =$	<table border="1" style="display: inline-table; border-collapse: collapse;"> <tr> <th style="width: 50%;">Minor Storm</th> <th style="width: 50%;">Major Storm</th> </tr> <tr> <td><math>15.9</math></td> <td><math>30.7</math></td> </tr> </table> cfs	Minor Storm	Major Storm	$15.9$	$30.7$
Minor Storm	Major Storm				
$15.9$	$30.7$				

## INLET ON A CONTINUOUS GRADE

Version 4.05 Released March 2017

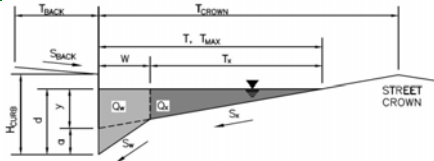


<b>Design Information (Input)</b>	MINOR	MAJOR	
Type of Inlet	CDOT Type R Curb Opening		
Local Depression (additional to continuous gutter depression 'a')	3.0	3.0	inches
Total Number of Units in the Inlet (Grate or Curb Opening)	1	1	
Length of a Single Unit Inlet (Grate or Curb Opening)	15.00	15.00	ft
Width of a Unit Grate (cannot be greater than W, Gutter Width)	N/A	N/A	ft
Clogging Factor for a Single Unit Grate (typical min. value = 0.5)	N/A	N/A	
Clogging Factor for a Single Unit Curb Opening (typical min. value = 0.1)	0.10	0.10	
<b>Street Hydraulics: OK - Q &lt; Allowable Street Capacity*</b>			
Total Inlet Interception Capacity	4.4	14.6	cfs
Total Inlet Carry-Over Flow (flow bypassing inlet)	0.0	7.2	cfs
Capture Percentage = $Q_i/Q_o =$	100	67	%

**ALLOWABLE CAPACITY FOR ONE-HALF OF STREET (Minor & Major Storm)**

(Based on Regulated Criteria for Maximum Allowable Flow Depth and Spread)

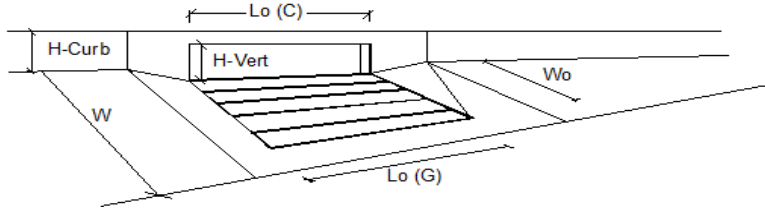
Project: \_\_\_\_\_  
 Inlet ID: \_\_\_\_\_  
 Enter Your Project Name Here \_\_\_\_\_  
 DP-2 INLET



Gutter Geometry (Enter data in the blue cells)													
Maximum Allowable Width for Spread Behind Curb	$T_{BACK} = 7.5$ ft												
Side Slope Behind Curb (leave blank for no conveyance credit behind curb)	$S_{BACK} = 0.020$ ft/ft												
Manning's Roughness Behind Curb (typically between 0.012 and 0.020)	$n_{BACK} = 0.013$												
Height of Curb at Gutter Flow Line	$H_{CURB} = 6.00$ inches												
Distance from Curb Face to Street Crown	$T_{CROWN} = 17.0$ ft												
Gutter Width	$W = 2.00$ ft												
Street Transverse Slope	$S_X = 0.020$ ft/ft												
Gutter Cross Slope (typically 2 inches over 24 inches or 0.083 ft/ft)	$S_W = 0.083$ ft/ft												
Street Longitudinal Slope - Enter 0 for sump condition	$S_O = 0.040$ ft/ft												
Manning's Roughness for Street Section (typically between 0.012 and 0.020)	$n_{STREET} = 0.016$												
Max. Allowable Spread for Minor & Major Storm	<table border="1"> <thead> <tr> <th></th> <th>Minor Storm</th> <th>Major Storm</th> <th></th> </tr> </thead> <tbody> <tr> <td><math>T_{MAX} =</math></td> <td>17.0</td> <td>17.0</td> <td>ft</td> </tr> <tr> <td><math>d_{MAX} =</math></td> <td>5.1</td> <td>7.8</td> <td>inches</td> </tr> </tbody> </table>		Minor Storm	Major Storm		$T_{MAX} =$	17.0	17.0	ft	$d_{MAX} =$	5.1	7.8	inches
	Minor Storm	Major Storm											
$T_{MAX} =$	17.0	17.0	ft										
$d_{MAX} =$	5.1	7.8	inches										
Max. Allowable Depth at Gutter Flowline for Minor & Major Storm													
Allow Flow Depth at Street Crown (leave blank for no)	<input type="checkbox"/> <input checked="" type="checkbox"/> check = yes												
<b>MINOR STORM Allowable Capacity is based on Depth Criterion</b>													
<b>MAJOR STORM Allowable Capacity is based on Depth Criterion</b>													
<b>Minor storm max. allowable capacity GOOD - greater than the design flow given on sheet 'Inlet Management'</b>													
<b>Major storm max. allowable capacity GOOD - greater than the design flow given on sheet 'Inlet Management'</b>													
$Q_{allow} =$	<table border="1"> <thead> <tr> <th></th> <th>Minor Storm</th> <th>Major Storm</th> <th></th> </tr> </thead> <tbody> <tr> <td></td> <td>15.9</td> <td>30.7</td> <td>cfs</td> </tr> </tbody> </table>		Minor Storm	Major Storm			15.9	30.7	cfs				
	Minor Storm	Major Storm											
	15.9	30.7	cfs										

## INLET ON A CONTINUOUS GRADE

Version 4.05 Released March 2017

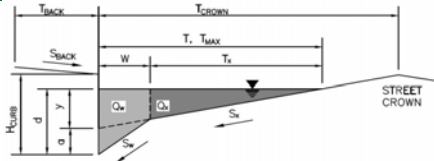


Design Information (Input)	MINOR	MAJOR	
Type of Inlet	CDOT Type R Curb Opening		
Local Depression (additional to continuous gutter depression 'a')	3.0	3.0	inches
Total Number of Units in the Inlet (Grate or Curb Opening)	1	1	
Length of a Single Unit Inlet (Grate or Curb Opening)	15.00	15.00	ft
Width of a Unit Grate (cannot be greater than W, Gutter Width)	N/A	N/A	ft
Clogging Factor for a Single Unit Grate (typical min. value = 0.5)	N/A	N/A	
Clogging Factor for a Single Unit Curb Opening (typical min. value = 0.1)	0.10	0.10	
<b>Street Hydraulics: OK - Q &lt; Allowable Street Capacity*</b>			
Total Inlet Interception Capacity	3.6	13.1	cfs
Total Inlet Carry-Over Flow (flow bypassing inlet)	0.0	4.5	cfs
Capture Percentage = $Q_i/Q_o =$	100	74	%

**ALLOWABLE CAPACITY FOR ONE-HALF OF STREET (Minor & Major Storm)**

(Based on Regulated Criteria for Maximum Allowable Flow Depth and Spread)

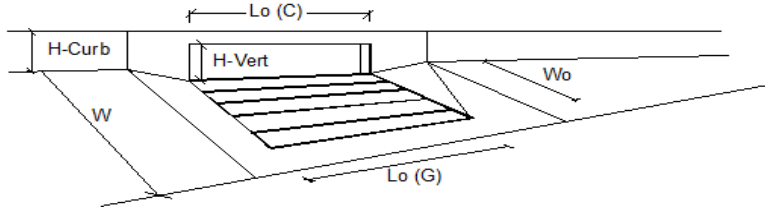
Project: \_\_\_\_\_  
 Inlet ID: \_\_\_\_\_  
 Enter Your Project Name Here \_\_\_\_\_  
 DP-3 INLET



Gutter Geometry (Enter data in the blue cells)							
Maximum Allowable Width for Spread Behind Curb	$T_{BACK} = 7.5$ ft						
Side Slope Behind Curb (leave blank for no conveyance credit behind curb)	$S_{BACK} = 0.020$ ft/ft						
Manning's Roughness Behind Curb (typically between 0.012 and 0.020)	$n_{BACK} = 0.013$						
Height of Curb at Gutter Flow Line	$H_{CURB} = 6.00$ inches						
Distance from Curb Face to Street Crown	$T_{CROWN} = 17.0$ ft						
Gutter Width	$W = 2.00$ ft						
Street Transverse Slope	$S_x = 0.020$ ft/ft						
Gutter Cross Slope (typically 2 inches over 24 inches or 0.083 ft/ft)	$S_w = 0.083$ ft/ft						
Street Longitudinal Slope - Enter 0 for sump condition	$S_o = 0.068$ ft/ft						
Manning's Roughness for Street Section (typically between 0.012 and 0.020)	$n_{STREET} = 0.016$						
Max. Allowable Spread for Minor & Major Storm	<table border="1"> <tr> <th>Minor Storm</th> <th>Major Storm</th> <th>ft</th> </tr> <tr> <td>17.0</td> <td>17.0</td> <td></td> </tr> </table>	Minor Storm	Major Storm	ft	17.0	17.0	
Minor Storm	Major Storm	ft					
17.0	17.0						
Max. Allowable Depth at Gutter Flowline for Minor & Major Storm	<table border="1"> <tr> <th>Minor Storm</th> <th>Major Storm</th> <th>inches</th> </tr> <tr> <td>5.1</td> <td>7.8</td> <td></td> </tr> </table>	Minor Storm	Major Storm	inches	5.1	7.8	
Minor Storm	Major Storm	inches					
5.1	7.8						
Allow Flow Depth at Street Crown (leave blank for no)	<table border="1"> <tr> <td><input type="checkbox"/></td> <td><input checked="" type="checkbox"/></td> <td>check = yes</td> </tr> </table>	<input type="checkbox"/>	<input checked="" type="checkbox"/>	check = yes			
<input type="checkbox"/>	<input checked="" type="checkbox"/>	check = yes					
<b>MINOR STORM Allowable Capacity is based on Depth Criterion</b>							
<b>MAJOR STORM Allowable Capacity is based on Depth Criterion</b>							
<b>Minor storm max. allowable capacity GOOD - greater than the design flow given on sheet 'Inlet Management'</b>							
<b>Major storm max. allowable capacity GOOD - greater than the design flow given on sheet 'Inlet Management'</b>							
$Q_{allow} =$	<table border="1"> <tr> <th>Minor Storm</th> <th>Major Storm</th> <th>cfs</th> </tr> <tr> <td>13.9</td> <td>26.2</td> <td></td> </tr> </table>	Minor Storm	Major Storm	cfs	13.9	26.2	
Minor Storm	Major Storm	cfs					
13.9	26.2						

## INLET ON A CONTINUOUS GRADE

Version 4.05 Released March 2017



<b>Design Information (Input)</b>	MINOR	MAJOR	
Type of Inlet	CDOT Type R Curb Opening		
Local Depression (additional to continuous gutter depression 'a')	3.0	3.0	inches
Total Number of Units in the Inlet (Grate or Curb Opening)	1	1	
Length of a Single Unit Inlet (Grate or Curb Opening)	15.00	15.00	ft
Width of a Unit Grate (cannot be greater than W, Gutter Width)	N/A	N/A	ft
Clogging Factor for a Single Unit Grate (typical min. value = 0.5)	N/A	N/A	
Clogging Factor for a Single Unit Curb Opening (typical min. value = 0.1)	0.10	0.10	
<b>Street Hydraulics: OK - Q &lt; Allowable Street Capacity*</b>			
Total Inlet Interception Capacity	5.6	14.9	cfs
Total Inlet Carry-Over Flow (flow bypassing inlet)	0.0	7.5	cfs
Capture Percentage = $Q_i/Q_o =$	100	67	%



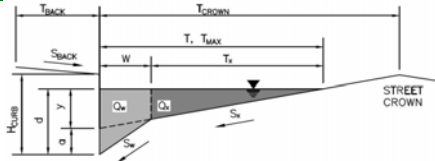
**ALLOWABLE CAPACITY FOR ONE-HALF OF STREET (Minor & Major Storm)**

(Based on Regulated Criteria for Maximum Allowable Flow Depth and Spread)

Project: \_\_\_\_\_  
 Inlet ID: \_\_\_\_\_

Enter Your Project Name Here

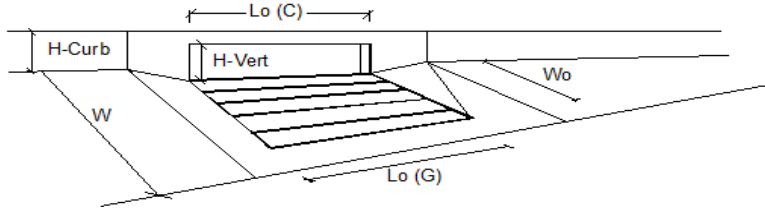
DP-4 INLET



Gutter Geometry (Enter data in the blue cells)							
Maximum Allowable Width for Spread Behind Curb	$T_{BACK} = 7.5$ ft						
Side Slope Behind Curb (leave blank for no conveyance credit behind curb)	$S_{BACK} = 0.020$ ft/ft						
Manning's Roughness Behind Curb (typically between 0.012 and 0.020)	$n_{BACK} = 0.013$						
Height of Curb at Gutter Flow Line	$H_{CURB} = 6.00$ inches						
Distance from Curb Face to Street Crown	$T_{CROWN} = 17.0$ ft						
Gutter Width	$W = 2.00$ ft						
Street Transverse Slope	$S_x = 0.020$ ft/ft						
Gutter Cross Slope (typically 2 inches over 24 inches or 0.083 ft/ft)	$S_w = 0.083$ ft/ft						
Street Longitudinal Slope - Enter 0 for sump condition	$S_o = 0.040$ ft/ft						
Manning's Roughness for Street Section (typically between 0.012 and 0.020)	$n_{STREET} = 0.016$						
Max. Allowable Spread for Minor & Major Storm	<table border="1" style="display: inline-table; border-collapse: collapse;"> <thead> <tr> <th style="width: 50%;">Minor Storm</th> <th style="width: 50%;">Major Storm</th> <th style="width: 50px;"></th> </tr> </thead> <tbody> <tr> <td style="text-align: center;">17.0</td> <td style="text-align: center;">17.0</td> <td style="text-align: right;">ft</td> </tr> </tbody> </table>	Minor Storm	Major Storm		17.0	17.0	ft
Minor Storm	Major Storm						
17.0	17.0	ft					
Max. Allowable Depth at Gutter Flowline for Minor & Major Storm	<table border="1" style="display: inline-table; border-collapse: collapse;"> <thead> <tr> <th style="width: 50%;">Minor Storm</th> <th style="width: 50%;">Major Storm</th> <th style="width: 50px;"></th> </tr> </thead> <tbody> <tr> <td style="text-align: center;">5.1</td> <td style="text-align: center;">7.8</td> <td style="text-align: right;">inches</td> </tr> </tbody> </table>	Minor Storm	Major Storm		5.1	7.8	inches
Minor Storm	Major Storm						
5.1	7.8	inches					
Allow Flow Depth at Street Crown (leave blank for no)	<table border="1" style="display: inline-table; border-collapse: collapse;"> <thead> <tr> <th style="width: 50%;"></th> <th style="width: 50%;"></th> <th style="width: 50px;"></th> </tr> </thead> <tbody> <tr> <td style="text-align: center;"><input type="checkbox"/></td> <td style="text-align: center;"><input checked="" type="checkbox"/></td> <td style="text-align: right;">check = yes</td> </tr> </tbody> </table>				<input type="checkbox"/>	<input checked="" type="checkbox"/>	check = yes
<input type="checkbox"/>	<input checked="" type="checkbox"/>	check = yes					
<b>MINOR STORM Allowable Capacity is based on Depth Criterion</b>							
<b>MAJOR STORM Allowable Capacity is based on Depth Criterion</b>							
<b>Minor storm max. allowable capacity GOOD - greater than the design flow given on sheet 'Inlet Management'</b>							
<b>Major storm max. allowable capacity GOOD - greater than the design flow given on sheet 'Inlet Management'</b>							
$Q_{allow} =$	<table border="1" style="display: inline-table; border-collapse: collapse;"> <thead> <tr> <th style="width: 50%;">Minor Storm</th> <th style="width: 50%;">Major Storm</th> <th style="width: 50px;"></th> </tr> </thead> <tbody> <tr> <td style="text-align: center;">15.9</td> <td style="text-align: center;">30.7</td> <td style="text-align: right;">cfs</td> </tr> </tbody> </table>	Minor Storm	Major Storm		15.9	30.7	cfs
Minor Storm	Major Storm						
15.9	30.7	cfs					

## INLET ON A CONTINUOUS GRADE

Version 4.05 Released March 2017

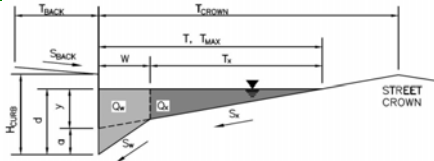


<b>Design Information (Input)</b>	MINOR	MAJOR	
Type of Inlet	CDOT Type R Curb Opening		
Local Depression (additional to continuous gutter depression 'a')	3.0	3.0	inches
Total Number of Units in the Inlet (Grate or Curb Opening)	1	1	
Length of a Single Unit Inlet (Grate or Curb Opening)	15.00	15.00	ft
Width of a Unit Grate (cannot be greater than W, Gutter Width)	N/A	N/A	ft
Clogging Factor for a Single Unit Grate (typical min. value = 0.5)	N/A	N/A	
Clogging Factor for a Single Unit Curb Opening (typical min. value = 0.1)	0.10	0.10	
<b>Street Hydraulics: OK - Q &lt; Allowable Street Capacity*</b>			
Total Inlet Interception Capacity	3.5	13.1	cfs
Total Inlet Carry-Over Flow (flow bypassing inlet)	0.0	4.6	cfs
Capture Percentage = $Q_i/Q_o =$	100	74	%

**ALLOWABLE CAPACITY FOR ONE-HALF OF STREET (Minor & Major Storm)**

(Based on Regulated Criteria for Maximum Allowable Flow Depth and Spread)

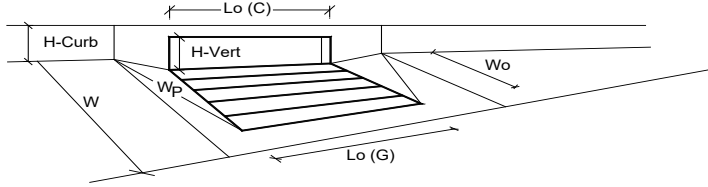
Project: \_\_\_\_\_ Enter Your Project Name Here  
 Inlet ID: \_\_\_\_\_ DP-5 INLET



<b>Gutter Geometry (Enter data in the blue cells)</b>					
Maximum Allowable Width for Spread Behind Curb	$T_{BACK} = 7.5$ ft				
Side Slope Behind Curb (leave blank for no conveyance credit behind curb)	$S_{BACK} = 0.020$ ft/ft				
Manning's Roughness Behind Curb (typically between 0.012 and 0.020)	$n_{BACK} = 0.013$				
Height of Curb at Gutter Flow Line	$H_{CURB} = 6.00$ inches				
Distance from Curb Face to Street Crown	$T_{CROWN} = 17.0$ ft				
Gutter Width	$W = 2.00$ ft				
Street Transverse Slope	$S_X = 0.020$ ft/ft				
Gutter Cross Slope (typically 2 inches over 24 inches or 0.083 ft/ft)	$S_W = 0.083$ ft/ft				
Street Longitudinal Slope - Enter 0 for sump condition	$S_D = 0.000$ ft/ft				
Manning's Roughness for Street Section (typically between 0.012 and 0.020)	$n_{STREET} = 0.016$				
Max. Allowable Spread for Minor & Major Storm	<table border="1" style="display: inline-table; border-collapse: collapse;"> <tr> <th style="width: 50%;">Minor Storm</th> <th style="width: 50%;">Major Storm</th> </tr> <tr> <td style="text-align: center;">17.0</td> <td style="text-align: center;">17.0</td> </tr> </table> ft	Minor Storm	Major Storm	17.0	17.0
Minor Storm	Major Storm				
17.0	17.0				
Max. Allowable Depth at Gutter Flowline for Minor & Major Storm	<table border="1" style="display: inline-table; border-collapse: collapse;"> <tr> <th style="width: 50%;">Minor Storm</th> <th style="width: 50%;">Major Storm</th> </tr> <tr> <td style="text-align: center;">5.1</td> <td style="text-align: center;">7.8</td> </tr> </table> inches	Minor Storm	Major Storm	5.1	7.8
Minor Storm	Major Storm				
5.1	7.8				
Check boxes are not applicable in SUMP conditions	<input type="checkbox"/> <input type="checkbox"/>				
<b>MINOR STORM Allowable Capacity is based on Depth Criterion</b>					
<b>MAJOR STORM Allowable Capacity is based on Depth Criterion</b>					
Q <sub>allow</sub> =	<table border="1" style="display: inline-table; border-collapse: collapse;"> <tr> <th style="width: 50%;">Minor Storm</th> <th style="width: 50%;">Major Storm</th> </tr> <tr> <td style="text-align: center;">SUMP</td> <td style="text-align: center;">SUMP</td> </tr> </table> cfs	Minor Storm	Major Storm	SUMP	SUMP
Minor Storm	Major Storm				
SUMP	SUMP				

## INLET IN A SUMP OR SAG LOCATION

Version 4.05 Released March 2017



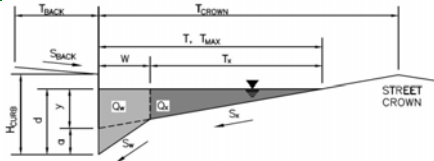
Design Information (Input)	MINOR	MAJOR	
Type of Inlet	CDOT Type R Curb Opening		
Local Depression (additional to continuous gutter depression 'a' from above)	3.00	3.00	inches
Number of Unit Inlets (Grate or Curb Opening)	1	1	
Water Depth at Flowline (outside of local depression)	5.1	7.8	inches
<b>Grate Information</b>	MINOR	MAJOR	<input checked="" type="checkbox"/> Override Depths
Length of a Unit Grate	N/A	N/A	feet
Width of a Unit Grate	N/A	N/A	feet
Area Opening Ratio for a Grate (typical values 0.15-0.90)	N/A	N/A	
Clogging Factor for a Single Grate (typical value 0.50 - 0.70)	N/A	N/A	
Grate Weir Coefficient (typical value 2.15 - 3.60)	N/A	N/A	
Grate Orifice Coefficient (typical value 0.60 - 0.80)	N/A	N/A	
<b>Curb Opening Information</b>	MINOR	MAJOR	
Length of a Unit Curb Opening	15.00	15.00	feet
Height of Vertical Curb Opening in Inches	6.00	6.00	inches
Height of Curb Orifice Throat in Inches	6.00	6.00	inches
Angle of Throat (see USDCM Figure ST-5)	63.40	63.40	degrees
Side Width for Depression Pan (typically the gutter width of 2 feet)	2.00	2.00	feet
Clogging Factor for a Single Curb Opening (typical value 0.10)	0.10	0.10	
Curb Opening Weir Coefficient (typical value 2.3-3.7)	3.60	3.60	
Curb Opening Orifice Coefficient (typical value 0.60 - 0.70)	0.67	0.67	
<b>Low Head Performance Reduction (Calculated)</b>	MINOR	MAJOR	
Depth for Grate Midwidth	N/A	N/A	ft
Depth for Curb Opening Weir Equation	0.26	0.48	ft
Combination Inlet Performance Reduction Factor for Long Inlets	0.48	0.74	
Curb Opening Performance Reduction Factor for Long Inlets	0.73	0.88	
Grated Inlet Performance Reduction Factor for Long Inlets	N/A	N/A	
<b>Total Inlet Interception Capacity (assumes clogged condition)</b>	MINOR	MAJOR	
<b>Q<sub>a</sub></b>	6.1	19.1	cfs
Q <sub>PEAK REQUIRED</sub>	2.7	17.6	cfs

Inlet Capacity IS GOOD for Minor and Major Storms(>Q PEAK)

**ALLOWABLE CAPACITY FOR ONE-HALF OF STREET (Minor & Major Storm)**

(Based on Regulated Criteria for Maximum Allowable Flow Depth and Spread)

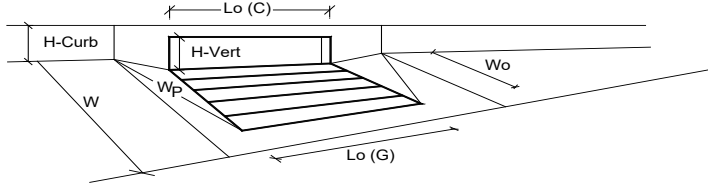
Project: \_\_\_\_\_ Enter Your Project Name Here  
 Inlet ID: \_\_\_\_\_ DP-6B INLET



<b>Gutter Geometry (Enter data in the blue cells)</b>																	
Maximum Allowable Width for Spread Behind Curb	$T_{BACK} = $ <input style="width: 50px;" type="text" value="7.5"/> ft																
Side Slope Behind Curb (leave blank for no conveyance credit behind curb)	$S_{BACK} = $ <input style="width: 50px;" type="text" value="0.020"/> ft/ft																
Manning's Roughness Behind Curb (typically between 0.012 and 0.020)	$n_{BACK} = $ <input style="width: 50px;" type="text" value="0.013"/>																
Height of Curb at Gutter Flow Line	$H_{CURB} = $ <input style="width: 50px;" type="text" value="6.00"/> inches																
Distance from Curb Face to Street Crown	$T_{CROWN} = $ <input style="width: 50px;" type="text" value="17.0"/> ft																
Gutter Width	$W = $ <input style="width: 50px;" type="text" value="2.00"/> ft																
Street Transverse Slope	$S_x = $ <input style="width: 50px;" type="text" value="0.020"/> ft/ft																
Gutter Cross Slope (typically 2 inches over 24 inches or 0.083 ft/ft)	$S_w = $ <input style="width: 50px;" type="text" value="0.083"/> ft/ft																
Street Longitudinal Slope - Enter 0 for sump condition	$S_o = $ <input style="width: 50px;" type="text" value="0.000"/> ft/ft																
Manning's Roughness for Street Section (typically between 0.012 and 0.020)	$n_{STREET} = $ <input style="width: 50px;" type="text" value="0.016"/>																
Max. Allowable Spread for Minor & Major Storm	<table border="1" style="display: inline-table; border-collapse: collapse;"> <thead> <tr> <th style="width: 50px;"></th> <th style="width: 50px; text-align: center;">Minor Storm</th> <th style="width: 50px; text-align: center;">Major Storm</th> <th style="width: 20px;"></th> </tr> </thead> <tbody> <tr> <td><math>T_{MAX} = </math></td> <td style="text-align: center;"><input style="width: 40px;" type="text" value="17.0"/></td> <td style="text-align: center;"><input style="width: 40px;" type="text" value="17.0"/></td> <td style="text-align: right;">ft</td> </tr> <tr> <td><math>d_{MAX} = </math></td> <td style="text-align: center;"><input style="width: 40px;" type="text" value="5.1"/></td> <td style="text-align: center;"><input style="width: 40px;" type="text" value="7.8"/></td> <td style="text-align: right;">inches</td> </tr> <tr> <td></td> <td style="text-align: center;"><input type="checkbox"/></td> <td style="text-align: center;"><input type="checkbox"/></td> <td></td> </tr> </tbody> </table>		Minor Storm	Major Storm		$T_{MAX} = $	<input style="width: 40px;" type="text" value="17.0"/>	<input style="width: 40px;" type="text" value="17.0"/>	ft	$d_{MAX} = $	<input style="width: 40px;" type="text" value="5.1"/>	<input style="width: 40px;" type="text" value="7.8"/>	inches		<input type="checkbox"/>	<input type="checkbox"/>	
	Minor Storm	Major Storm															
$T_{MAX} = $	<input style="width: 40px;" type="text" value="17.0"/>	<input style="width: 40px;" type="text" value="17.0"/>	ft														
$d_{MAX} = $	<input style="width: 40px;" type="text" value="5.1"/>	<input style="width: 40px;" type="text" value="7.8"/>	inches														
	<input type="checkbox"/>	<input type="checkbox"/>															
Max. Allowable Depth at Gutter Flowline for Minor & Major Storm																	
Check boxes are not applicable in SUMP conditions																	
<b>MINOR STORM Allowable Capacity is based on Depth Criterion</b>																	
<b>MAJOR STORM Allowable Capacity is based on Depth Criterion</b>																	
$Q_{allow} = $	<table border="1" style="display: inline-table; border-collapse: collapse;"> <thead> <tr> <th style="width: 50px;"></th> <th style="width: 50px; text-align: center;">Minor Storm</th> <th style="width: 50px; text-align: center;">Major Storm</th> <th style="width: 20px;"></th> </tr> </thead> <tbody> <tr> <td></td> <td style="text-align: center;"><input style="width: 40px;" type="text" value="SUMP"/></td> <td style="text-align: center;"><input style="width: 40px;" type="text" value="SUMP"/></td> <td style="text-align: right;">cfs</td> </tr> </tbody> </table>		Minor Storm	Major Storm			<input style="width: 40px;" type="text" value="SUMP"/>	<input style="width: 40px;" type="text" value="SUMP"/>	cfs								
	Minor Storm	Major Storm															
	<input style="width: 40px;" type="text" value="SUMP"/>	<input style="width: 40px;" type="text" value="SUMP"/>	cfs														

## INLET IN A SUMP OR SAG LOCATION

Version 4.05 Released March 2017

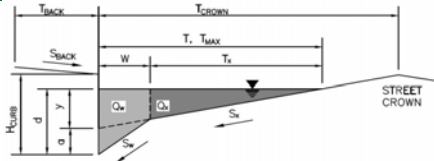


Design Information (Input)	MINOR	MAJOR	
Type of Inlet	CDOT Type R Curb Opening		
Local Depression (additional to continuous gutter depression 'a' from above)	3.00	3.00	inches
Number of Unit Inlets (Grate or Curb Opening)	1	1	
Water Depth at Flowline (outside of local depression)	5.1	7.8	inches
<b>Grate Information</b>	MINOR	MAJOR	<input checked="" type="checkbox"/> Override Depths
Length of a Unit Grate	N/A	N/A	feet
Width of a Unit Grate	N/A	N/A	feet
Area Opening Ratio for a Grate (typical values 0.15-0.90)	N/A	N/A	
Clogging Factor for a Single Grate (typical value 0.50 - 0.70)	N/A	N/A	
Grate Weir Coefficient (typical value 2.15 - 3.60)	N/A	N/A	
Grate Orifice Coefficient (typical value 0.60 - 0.80)	N/A	N/A	
<b>Curb Opening Information</b>	MINOR	MAJOR	
Length of a Unit Curb Opening	15.00	15.00	feet
Height of Vertical Curb Opening in Inches	6.00	6.00	inches
Height of Curb Orifice Throat in Inches	6.00	6.00	inches
Angle of Throat (see USDCM Figure ST-5)	63.40	63.40	degrees
Side Width for Depression Pan (typically the gutter width of 2 feet)	2.00	2.00	feet
Clogging Factor for a Single Curb Opening (typical value 0.10)	0.10	0.10	
Curb Opening Weir Coefficient (typical value 2.3-3.7)	3.60	3.60	
Curb Opening Orifice Coefficient (typical value 0.60 - 0.70)	0.67	0.67	
<b>Low Head Performance Reduction (Calculated)</b>	MINOR	MAJOR	
Depth for Grate Midwidth	N/A	N/A	ft
Depth for Curb Opening Weir Equation	0.26	0.48	ft
Combination Inlet Performance Reduction Factor for Long Inlets	0.48	0.74	
Curb Opening Performance Reduction Factor for Long Inlets	0.73	0.88	
Grated Inlet Performance Reduction Factor for Long Inlets	N/A	N/A	
<b>Total Inlet Interception Capacity (assumes clogged condition)</b>	MINOR	MAJOR	
Inlet Capacity IS GOOD for Minor and Major Storms(>Q PEAK)	6.1	19.1	cfs
Q <sub>PEAK REQUIRED</sub>	4.2	10.1	cfs

**ALLOWABLE CAPACITY FOR ONE-HALF OF STREET (Minor & Major Storm)**

(Based on Regulated Criteria for Maximum Allowable Flow Depth and Spread)

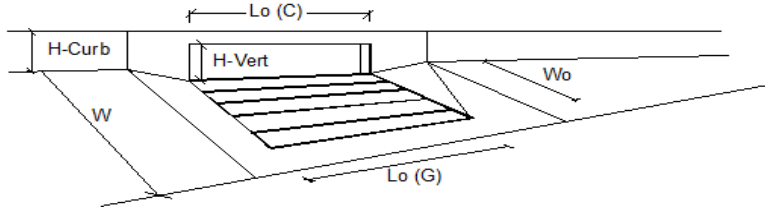
Project: \_\_\_\_\_ Enter Your Project Name Here  
 Inlet ID: \_\_\_\_\_ DP-6A INLET



Gutter Geometry (Enter data in the blue cells)					
Maximum Allowable Width for Spread Behind Curb	$T_{BACK} = 7.5$ ft				
Side Slope Behind Curb (leave blank for no conveyance credit behind curb)	$S_{BACK} = 0.020$ ft/ft				
Manning's Roughness Behind Curb (typically between 0.012 and 0.020)	$n_{BACK} = 0.013$				
Height of Curb at Gutter Flow Line	$H_{CURB} = 6.00$ inches				
Distance from Curb Face to Street Crown	$T_{CROWN} = 17.0$ ft				
Gutter Width	$W = 2.00$ ft				
Street Transverse Slope	$S_x = 0.020$ ft/ft				
Gutter Cross Slope (typically 2 inches over 24 inches or 0.083 ft/ft)	$S_w = 0.083$ ft/ft				
Street Longitudinal Slope - Enter 0 for sump condition	$S_o = 0.040$ ft/ft				
Manning's Roughness for Street Section (typically between 0.012 and 0.020)	$n_{STREET} = 0.016$				
Max. Allowable Spread for Minor & Major Storm	<table border="1" style="display: inline-table; border-collapse: collapse;"> <tr> <th style="width: 50%;">Minor Storm</th> <th style="width: 50%;">Major Storm</th> </tr> <tr> <td style="text-align: center;"><math>T_{MAX} = 17.0</math></td> <td style="text-align: center;"><math>T_{MAX} = 17.0</math></td> </tr> </table> ft	Minor Storm	Major Storm	$T_{MAX} = 17.0$	$T_{MAX} = 17.0$
Minor Storm	Major Storm				
$T_{MAX} = 17.0$	$T_{MAX} = 17.0$				
Max. Allowable Depth at Gutter Flowline for Minor & Major Storm	<table border="1" style="display: inline-table; border-collapse: collapse;"> <tr> <th style="width: 50%;">Minor Storm</th> <th style="width: 50%;">Major Storm</th> </tr> <tr> <td style="text-align: center;"><math>d_{MAX} = 5.1</math></td> <td style="text-align: center;"><math>d_{MAX} = 7.8</math></td> </tr> </table> inches	Minor Storm	Major Storm	$d_{MAX} = 5.1$	$d_{MAX} = 7.8$
Minor Storm	Major Storm				
$d_{MAX} = 5.1$	$d_{MAX} = 7.8$				
Allow Flow Depth at Street Crown (leave blank for no)	<input type="checkbox"/> <input type="checkbox"/> check = yes				
<b>MINOR STORM Allowable Capacity is based on Depth Criterion</b>					
<b>MAJOR STORM Allowable Capacity is based on Spread Criterion</b>					
Minor storm max. allowable capacity GOOD - greater than the design flow given on sheet 'Inlet Management'	<table border="1" style="display: inline-table; border-collapse: collapse;"> <tr> <th style="width: 50%;">Minor Storm</th> <th style="width: 50%;">Major Storm</th> </tr> <tr> <td style="text-align: center;"><math>Q_{allow} = 15.9</math></td> <td style="text-align: center;"><math>Q_{allow} = 21.7</math></td> </tr> </table> cfs	Minor Storm	Major Storm	$Q_{allow} = 15.9$	$Q_{allow} = 21.7$
Minor Storm	Major Storm				
$Q_{allow} = 15.9$	$Q_{allow} = 21.7$				
Major storm max. allowable capacity GOOD - greater than the design flow given on sheet 'Inlet Management'					

## INLET ON A CONTINUOUS GRADE

Version 4.05 Released March 2017



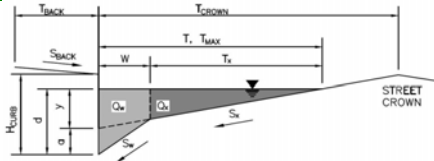
Design Information (Input)	MINOR	MAJOR	
Type of Inlet	CDOT Type R Curb Opening		
Local Depression (additional to continuous gutter depression 'a')	3.0	3.0	inches
Total Number of Units in the Inlet (Grate or Curb Opening)	1	1	
Length of a Single Unit Inlet (Grate or Curb Opening)	5.00	5.00	ft
Width of a Unit Grate (cannot be greater than W, Gutter Width)	N/A	N/A	ft
Clogging Factor for a Single Unit Grate (typical min. value = 0.5)	N/A	N/A	
Clogging Factor for a Single Unit Curb Opening (typical min. value = 0.1)	0.10	0.10	
<b>Street Hydraulics: OK - Q &lt; Allowable Street Capacity*</b>			
Total Inlet Interception Capacity	2.7	3.7	cfs
Total Inlet Carry-Over Flow (flow bypassing inlet)	1.8	5.2	cfs
Capture Percentage = $Q_i/Q_o =$	61	42	%



**ALLOWABLE CAPACITY FOR ONE-HALF OF STREET (Minor & Major Storm)**

(Based on Regulated Criteria for Maximum Allowable Flow Depth and Spread)

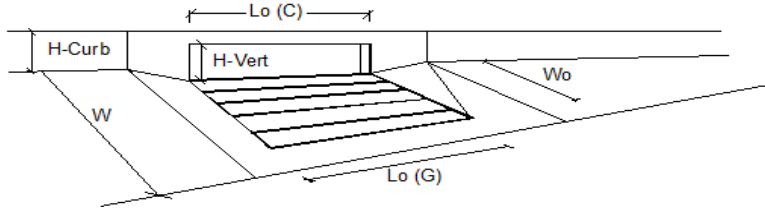
Project: \_\_\_\_\_  
 Inlet ID: \_\_\_\_\_  
 Enter Your Project Name Here \_\_\_\_\_  
 DP-9 INLET



Gutter Geometry (Enter data in the blue cells)													
Maximum Allowable Width for Spread Behind Curb	$T_{BACK} = 7.5$ ft												
Side Slope Behind Curb (leave blank for no conveyance credit behind curb)	$S_{BACK} = 0.020$ ft/ft												
Manning's Roughness Behind Curb (typically between 0.012 and 0.020)	$n_{BACK} = 0.013$												
Height of Curb at Gutter Flow Line	$H_{CURB} = 6.00$ inches												
Distance from Curb Face to Street Crown	$T_{CROWN} = 17.0$ ft												
Gutter Width	$W = 2.00$ ft												
Street Transverse Slope	$S_X = 0.020$ ft/ft												
Gutter Cross Slope (typically 2 inches over 24 inches or 0.083 ft/ft)	$S_W = 0.083$ ft/ft												
Street Longitudinal Slope - Enter 0 for sump condition	$S_O = 0.040$ ft/ft												
Manning's Roughness for Street Section (typically between 0.012 and 0.020)	$n_{STREET} = 0.016$												
Max. Allowable Spread for Minor & Major Storm	<table border="1" style="display: inline-table; border-collapse: collapse;"> <thead> <tr> <th></th> <th>Minor Storm</th> <th>Major Storm</th> <th></th> </tr> </thead> <tbody> <tr> <td><math>T_{MAX} =</math></td> <td>17.0</td> <td>17.0</td> <td>ft</td> </tr> <tr> <td><math>d_{MAX} =</math></td> <td>5.1</td> <td>7.8</td> <td>inches</td> </tr> </tbody> </table>		Minor Storm	Major Storm		$T_{MAX} =$	17.0	17.0	ft	$d_{MAX} =$	5.1	7.8	inches
	Minor Storm	Major Storm											
$T_{MAX} =$	17.0	17.0	ft										
$d_{MAX} =$	5.1	7.8	inches										
Max. Allowable Depth at Gutter Flowline for Minor & Major Storm													
Allow Flow Depth at Street Crown (leave blank for no)	<input type="checkbox"/> <input checked="" type="checkbox"/> check = yes												
<b>MINOR STORM Allowable Capacity is based on Depth Criterion</b>													
<b>MAJOR STORM Allowable Capacity is based on Depth Criterion</b>													
<b>Minor storm max. allowable capacity GOOD - greater than the design flow given on sheet 'Inlet Management'</b>													
<b>Major storm max. allowable capacity GOOD - greater than the design flow given on sheet 'Inlet Management'</b>													
$Q_{allow} =$	<table border="1" style="display: inline-table; border-collapse: collapse;"> <thead> <tr> <th></th> <th>Minor Storm</th> <th>Major Storm</th> <th></th> </tr> </thead> <tbody> <tr> <td></td> <td>15.9</td> <td>30.7</td> <td>cfs</td> </tr> </tbody> </table>		Minor Storm	Major Storm			15.9	30.7	cfs				
	Minor Storm	Major Storm											
	15.9	30.7	cfs										

## INLET ON A CONTINUOUS GRADE

Version 4.05 Released March 2017

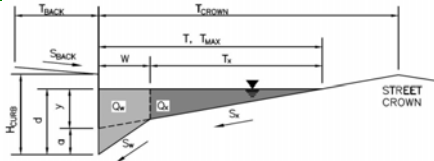


Design Information (Input)	MINOR	MAJOR	
Type of Inlet	CDOT Type R Curb Opening		
Local Depression (additional to continuous gutter depression 'a')	3.0	3.0	inches
Total Number of Units in the Inlet (Grate or Curb Opening)	1	1	
Length of a Single Unit Inlet (Grate or Curb Opening)	15.00	15.00	ft
Width of a Unit Grate (cannot be greater than W, Gutter Width)	N/A	N/A	ft
Clogging Factor for a Single Unit Grate (typical min. value = 0.5)	N/A	N/A	
Clogging Factor for a Single Unit Curb Opening (typical min. value = 0.1)	0.10	0.10	
<b>Street Hydraulics: OK - Q &lt; Allowable Street Capacity*</b>			
Total Inlet Interception Capacity	7.5	13.8	cfs
Total Inlet Carry-Over Flow (flow bypassing inlet)	0.1	5.8	cfs
Capture Percentage = $Q_p/Q_o =$	99	71	%

**ALLOWABLE CAPACITY FOR ONE-HALF OF STREET (Minor & Major Storm)**

(Based on Regulated Criteria for Maximum Allowable Flow Depth and Spread)

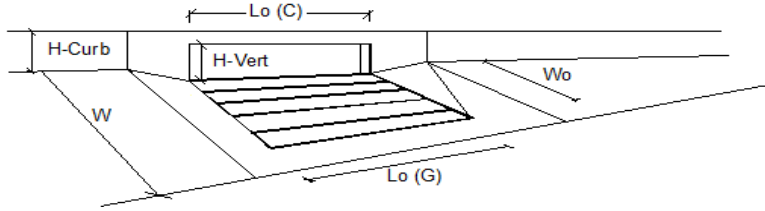
Project: \_\_\_\_\_  
 Inlet ID: \_\_\_\_\_  
 Enter Your Project Name Here \_\_\_\_\_  
 DP-10 INLET



Gutter Geometry (Enter data in the blue cells)					
Maximum Allowable Width for Spread Behind Curb	$T_{BACK} = 7.5$ ft				
Side Slope Behind Curb (leave blank for no conveyance credit behind curb)	$S_{BACK} = 0.020$ ft/ft				
Manning's Roughness Behind Curb (typically between 0.012 and 0.020)	$n_{BACK} = 0.013$				
Height of Curb at Gutter Flow Line	$H_{CURB} = 6.00$ inches				
Distance from Curb Face to Street Crown	$T_{CROWN} = 17.0$ ft				
Gutter Width	$W = 2.00$ ft				
Street Transverse Slope	$S_x = 0.020$ ft/ft				
Gutter Cross Slope (typically 2 inches over 24 inches or 0.083 ft/ft)	$S_w = 0.083$ ft/ft				
Street Longitudinal Slope - Enter 0 for sump condition	$S_o = 0.040$ ft/ft				
Manning's Roughness for Street Section (typically between 0.012 and 0.020)	$n_{STREET} = 0.016$				
Max. Allowable Spread for Minor & Major Storm	<table border="1" style="display: inline-table; border-collapse: collapse;"> <tr> <th style="width: 50%;">Minor Storm</th> <th style="width: 50%;">Major Storm</th> </tr> <tr> <td><math>T_{MAX} = 17.0</math></td> <td><math>T_{MAX} = 17.0</math></td> </tr> </table> ft	Minor Storm	Major Storm	$T_{MAX} = 17.0$	$T_{MAX} = 17.0$
Minor Storm	Major Storm				
$T_{MAX} = 17.0$	$T_{MAX} = 17.0$				
Max. Allowable Depth at Gutter Flowline for Minor & Major Storm	<table border="1" style="display: inline-table; border-collapse: collapse;"> <tr> <th style="width: 50%;">Minor Storm</th> <th style="width: 50%;">Major Storm</th> </tr> <tr> <td><math>d_{MAX} = 5.1</math></td> <td><math>d_{MAX} = 7.8</math></td> </tr> </table> inches	Minor Storm	Major Storm	$d_{MAX} = 5.1$	$d_{MAX} = 7.8$
Minor Storm	Major Storm				
$d_{MAX} = 5.1$	$d_{MAX} = 7.8$				
Allow Flow Depth at Street Crown (leave blank for no)	<table border="1" style="display: inline-table; border-collapse: collapse;"> <tr> <th style="width: 50%;">Minor Storm</th> <th style="width: 50%;">Major Storm</th> </tr> <tr> <td style="text-align: center;"><input type="checkbox"/></td> <td style="text-align: center;"><input checked="" type="checkbox"/></td> </tr> </table> check = yes	Minor Storm	Major Storm	<input type="checkbox"/>	<input checked="" type="checkbox"/>
Minor Storm	Major Storm				
<input type="checkbox"/>	<input checked="" type="checkbox"/>				
<b>MINOR STORM Allowable Capacity is based on Depth Criterion</b>					
<b>MAJOR STORM Allowable Capacity is based on Depth Criterion</b>					
<b>Minor storm max. allowable capacity GOOD - greater than the design flow given on sheet 'Inlet Management'</b>					
<b>Major storm max. allowable capacity GOOD - greater than the design flow given on sheet 'Inlet Management'</b>					
$Q_{allow} =$	<table border="1" style="display: inline-table; border-collapse: collapse;"> <tr> <th style="width: 50%;">Minor Storm</th> <th style="width: 50%;">Major Storm</th> </tr> <tr> <td><math>15.9</math></td> <td><math>30.7</math></td> </tr> </table> cfs	Minor Storm	Major Storm	$15.9$	$30.7$
Minor Storm	Major Storm				
$15.9$	$30.7$				

## INLET ON A CONTINUOUS GRADE

Version 4.05 Released March 2017

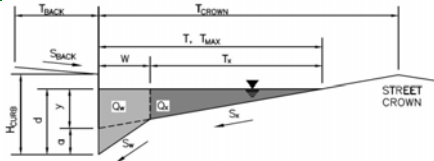


Design Information (Input)	MINOR	MAJOR	
Type of Inlet	CDOT Type R Curb Opening		
Local Depression (additional to continuous gutter depression 'a')	3.0	3.0	inches
Total Number of Units in the Inlet (Grate or Curb Opening)	1	1	
Length of a Single Unit Inlet (Grate or Curb Opening)	15.00	15.00	ft
Width of a Unit Grate (cannot be greater than W, Gutter Width)	N/A	N/A	ft
Clogging Factor for a Single Unit Grate (typical min. value = 0.5)	N/A	N/A	
Clogging Factor for a Single Unit Curb Opening (typical min. value = 0.1)	0.10	0.10	
<b>Street Hydraulics: OK - Q &lt; Allowable Street Capacity*</b>			
Total Inlet Interception Capacity	5.6	13.4	cfs
Total Inlet Carry-Over Flow (flow bypassing inlet)	0.0	5.1	cfs
Capture Percentage = $Q_i/Q_o =$	100	73	%

**ALLOWABLE CAPACITY FOR ONE-HALF OF STREET (Minor & Major Storm)**

(Based on Regulated Criteria for Maximum Allowable Flow Depth and Spread)

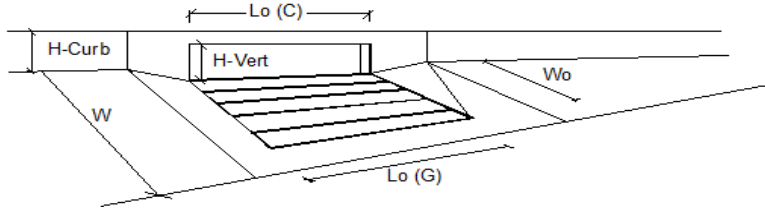
Project: \_\_\_\_\_  
 Inlet ID: \_\_\_\_\_  
 Enter Your Project Name Here \_\_\_\_\_  
 DP-11 INLET



Gutter Geometry (Enter data in the blue cells)					
Maximum Allowable Width for Spread Behind Curb	$T_{BACK} = 7.5$ ft				
Side Slope Behind Curb (leave blank for no conveyance credit behind curb)	$S_{BACK} = 0.020$ ft/ft				
Manning's Roughness Behind Curb (typically between 0.012 and 0.020)	$n_{BACK} = 0.020$				
Height of Curb at Gutter Flow Line	$H_{CURB} = 6.00$ inches				
Distance from Curb Face to Street Crown	$T_{CROWN} = 17.0$ ft				
Gutter Width	$W = 2.00$ ft				
Street Transverse Slope	$S_x = 0.020$ ft/ft				
Gutter Cross Slope (typically 2 inches over 24 inches or 0.083 ft/ft)	$S_w = 0.083$ ft/ft				
Street Longitudinal Slope - Enter 0 for sump condition	$S_o = 0.040$ ft/ft				
Manning's Roughness for Street Section (typically between 0.012 and 0.020)	$n_{STREET} = 0.016$				
Max. Allowable Spread for Minor & Major Storm	<table border="1" style="display: inline-table; border-collapse: collapse;"> <tr> <th style="width: 50%;">Minor Storm</th> <th style="width: 50%;">Major Storm</th> </tr> <tr> <td><math>T_{MAX} = 17.0</math></td> <td><math>T_{MAX} = 17.0</math></td> </tr> </table> ft	Minor Storm	Major Storm	$T_{MAX} = 17.0$	$T_{MAX} = 17.0$
Minor Storm	Major Storm				
$T_{MAX} = 17.0$	$T_{MAX} = 17.0$				
Max. Allowable Depth at Gutter Flowline for Minor & Major Storm	<table border="1" style="display: inline-table; border-collapse: collapse;"> <tr> <th style="width: 50%;">Minor Storm</th> <th style="width: 50%;">Major Storm</th> </tr> <tr> <td><math>d_{MAX} = 5.1</math></td> <td><math>d_{MAX} = 7.8</math></td> </tr> </table> inches	Minor Storm	Major Storm	$d_{MAX} = 5.1$	$d_{MAX} = 7.8$
Minor Storm	Major Storm				
$d_{MAX} = 5.1$	$d_{MAX} = 7.8$				
Allow Flow Depth at Street Crown (leave blank for no)	<table border="1" style="display: inline-table; border-collapse: collapse;"> <tr> <td style="width: 50%; text-align: center;"><input type="checkbox"/></td> <td style="width: 50%; text-align: center;"><input checked="" type="checkbox"/></td> </tr> </table> check = yes	<input type="checkbox"/>	<input checked="" type="checkbox"/>		
<input type="checkbox"/>	<input checked="" type="checkbox"/>				
<b>MINOR STORM Allowable Capacity is based on Depth Criterion</b>					
<b>MAJOR STORM Allowable Capacity is based on Depth Criterion</b>					
<b>Minor storm max. allowable capacity GOOD - greater than the design flow given on sheet 'Inlet Management'</b>					
<b>Major storm max. allowable capacity GOOD - greater than the design flow given on sheet 'Inlet Management'</b>					
$Q_{allow} =$	<table border="1" style="display: inline-table; border-collapse: collapse;"> <tr> <th style="width: 50%;">Minor Storm</th> <th style="width: 50%;">Major Storm</th> </tr> <tr> <td><math>15.9</math></td> <td><math>30.2</math></td> </tr> </table> cfs	Minor Storm	Major Storm	$15.9$	$30.2$
Minor Storm	Major Storm				
$15.9$	$30.2$				

## INLET ON A CONTINUOUS GRADE

Version 4.05 Released March 2017

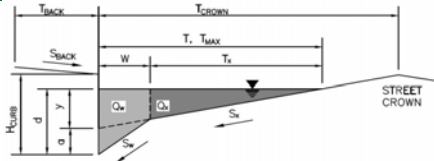


Design Information (Input)	MINOR	MAJOR	
Type of Inlet	CDOT Type R Curb Opening		
Local Depression (additional to continuous gutter depression 'a')	3.0	3.0	inches
Total Number of Units in the Inlet (Grate or Curb Opening)	1	1	
Length of a Single Unit Inlet (Grate or Curb Opening)	10.00	10.00	ft
Width of a Unit Grate (cannot be greater than W, Gutter Width)	N/A	N/A	ft
Clogging Factor for a Single Unit Grate (typical min. value = 0.5)	N/A	N/A	
Clogging Factor for a Single Unit Curb Opening (typical min. value = 0.1)	0.10	0.10	
<b>Street Hydraulics: OK - Q &lt; Allowable Street Capacity*</b>			
Total Inlet Interception Capacity	2.0	6.9	cfs
Total Inlet Carry-Over Flow (flow bypassing inlet)	0.0	2.3	cfs
Capture Percentage = $Q_p/Q_o =$	100	75	%

**ALLOWABLE CAPACITY FOR ONE-HALF OF STREET (Minor & Major Storm)**

(Based on Regulated Criteria for Maximum Allowable Flow Depth and Spread)

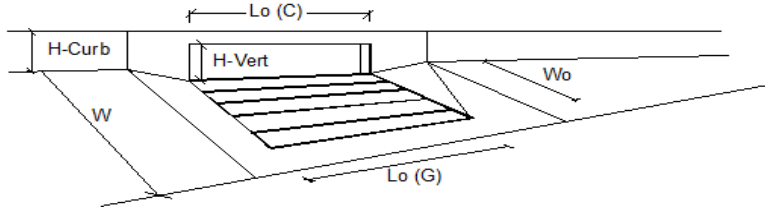
Project: \_\_\_\_\_  
 Inlet ID: \_\_\_\_\_  
 Enter Your Project Name Here \_\_\_\_\_  
 DP-12 INLET



Gutter Geometry (Enter data in the blue cells)					
Maximum Allowable Width for Spread Behind Curb	$T_{BACK} = 7.5$ ft				
Side Slope Behind Curb (leave blank for no conveyance credit behind curb)	$S_{BACK} = 0.020$ ft/ft				
Manning's Roughness Behind Curb (typically between 0.012 and 0.020)	$n_{BACK} = 0.013$				
Height of Curb at Gutter Flow Line	$H_{CURB} = 6.00$ inches				
Distance from Curb Face to Street Crown	$T_{CROWN} = 17.0$ ft				
Gutter Width	$W = 2.00$ ft				
Street Transverse Slope	$S_x = 0.020$ ft/ft				
Gutter Cross Slope (typically 2 inches over 24 inches or 0.083 ft/ft)	$S_w = 0.083$ ft/ft				
Street Longitudinal Slope - Enter 0 for sump condition	$S_o = 0.050$ ft/ft				
Manning's Roughness for Street Section (typically between 0.012 and 0.020)	$n_{STREET} = 0.016$				
Max. Allowable Spread for Minor & Major Storm	<table border="1" style="display: inline-table; border-collapse: collapse;"> <tr> <th style="width: 50%;">Minor Storm</th> <th style="width: 50%;">Major Storm</th> </tr> <tr> <td style="text-align: center;"><math>T_{MAX} = 17.0</math></td> <td style="text-align: center;"><math>T_{MAX} = 17.0</math></td> </tr> </table> ft	Minor Storm	Major Storm	$T_{MAX} = 17.0$	$T_{MAX} = 17.0$
Minor Storm	Major Storm				
$T_{MAX} = 17.0$	$T_{MAX} = 17.0$				
Max. Allowable Depth at Gutter Flowline for Minor & Major Storm	<table border="1" style="display: inline-table; border-collapse: collapse;"> <tr> <th style="width: 50%;">Minor Storm</th> <th style="width: 50%;">Major Storm</th> </tr> <tr> <td style="text-align: center;"><math>d_{MAX} = 5.1</math></td> <td style="text-align: center;"><math>d_{MAX} = 7.8</math></td> </tr> </table> inches	Minor Storm	Major Storm	$d_{MAX} = 5.1$	$d_{MAX} = 7.8$
Minor Storm	Major Storm				
$d_{MAX} = 5.1$	$d_{MAX} = 7.8$				
Allow Flow Depth at Street Crown (leave blank for no)	<table border="1" style="display: inline-table; border-collapse: collapse;"> <tr> <th style="width: 50%;">Minor Storm</th> <th style="width: 50%;">Major Storm</th> </tr> <tr> <td style="text-align: center;"><input type="checkbox"/></td> <td style="text-align: center;"><input checked="" type="checkbox"/></td> </tr> </table> check = yes	Minor Storm	Major Storm	<input type="checkbox"/>	<input checked="" type="checkbox"/>
Minor Storm	Major Storm				
<input type="checkbox"/>	<input checked="" type="checkbox"/>				
<b>MINOR STORM Allowable Capacity is based on Depth Criterion</b>					
<b>MAJOR STORM Allowable Capacity is based on Depth Criterion</b>					
Minor storm max. allowable capacity GOOD - greater than the design flow given on sheet 'Inlet Management'					
Major storm max. allowable capacity GOOD - greater than the design flow given on sheet 'Inlet Management'					
Allowable Capacity	<table border="1" style="display: inline-table; border-collapse: collapse;"> <tr> <th style="width: 50%;">Minor Storm</th> <th style="width: 50%;">Major Storm</th> </tr> <tr> <td style="text-align: center;"><math>Q_{allow} = 15.2</math></td> <td style="text-align: center;"><math>Q_{allow} = 28.7</math></td> </tr> </table> cfs	Minor Storm	Major Storm	$Q_{allow} = 15.2$	$Q_{allow} = 28.7$
Minor Storm	Major Storm				
$Q_{allow} = 15.2$	$Q_{allow} = 28.7$				

## INLET ON A CONTINUOUS GRADE

Version 4.05 Released March 2017



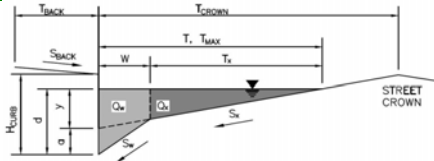
Design Information (Input)	MINOR	MAJOR	
Type of Inlet	CDOT Type R Curb Opening		
Local Depression (additional to continuous gutter depression 'a')	3.0	3.0	inches
Total Number of Units in the Inlet (Grate or Curb Opening)	1	1	
Length of a Single Unit Inlet (Grate or Curb Opening)	10.00	10.00	ft
Width of a Unit Grate (cannot be greater than W, Gutter Width)	N/A	N/A	ft
Clogging Factor for a Single Unit Grate (typical min. value = 0.5)	N/A	N/A	
Clogging Factor for a Single Unit Curb Opening (typical min. value = 0.1)	0.10	0.10	
<b>Street Hydraulics: OK - Q &lt; Allowable Street Capacity*</b>			
Total Inlet Interception Capacity	4.2	7.1	cfs
Total Inlet Carry-Over Flow (flow bypassing inlet)	0.1	2.6	cfs
Capture Percentage = $Q_p/Q_o =$	98	73	%



**ALLOWABLE CAPACITY FOR ONE-HALF OF STREET (Minor & Major Storm)**

(Based on Regulated Criteria for Maximum Allowable Flow Depth and Spread)

Project: \_\_\_\_\_ Enter Your Project Name Here  
 Inlet ID: \_\_\_\_\_ DP-13 INLET



**Gutter Geometry (Enter data in the blue cells)**

Maximum Allowable Width for Spread Behind Curb  
 Side Slope Behind Curb (leave blank for no conveyance credit behind curb)  
 Manning's Roughness Behind Curb (typically between 0.012 and 0.020)  
 Height of Curb at Gutter Flow Line  
 Distance from Curb Face to Street Crown  
 Gutter Width  
 Street Transverse Slope  
 Gutter Cross Slope (typically 2 inches over 24 inches or 0.083 ft/ft)  
 Street Longitudinal Slope - Enter 0 for sump condition  
 Manning's Roughness for Street Section (typically between 0.012 and 0.020)

$T_{BACK} = 7.5$  ft  
 $S_{BACK} = 0.020$  ft/ft  
 $n_{BACK} = 0.013$

$H_{CURB} = 6.00$  inches  
 $T_{CROWN} = 17.0$  ft  
 $W = 2.00$  ft  
 $S_x = 0.020$  ft/ft  
 $S_w = 0.083$  ft/ft  
 $S_o = 0.000$  ft/ft  
 $n_{STREET} = 0.016$

Max. Allowable Spread for Minor & Major Storm  
 Max. Allowable Depth at Gutter Flowline for Minor & Major Storm  
 Check boxes are not applicable in SUMP conditions

	Minor Storm	Major Storm	
$T_{MAX} =$	17.0	17.0	ft
$d_{MAX} =$	5.1	7.8	inches
	<input type="checkbox"/>	<input type="checkbox"/>	

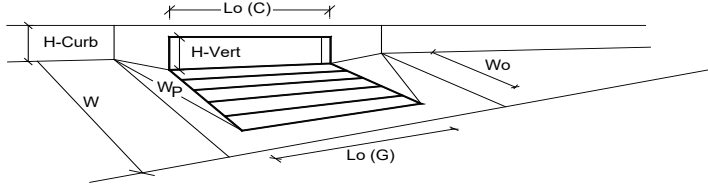
**MINOR STORM** Allowable Capacity is based on Depth Criterion  
**MAJOR STORM** Allowable Capacity is based on Depth Criterion

$Q_{allow} =$ 

Minor Storm	Major Storm	
SUMP	SUMP	cfs

## INLET IN A SUMP OR SAG LOCATION

Version 4.05 Released March 2017

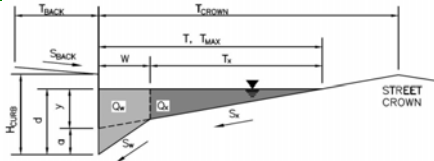


Design Information (Input)	MINOR	MAJOR	
Type of Inlet	CDOT Type R Curb Opening		
Local Depression (additional to continuous gutter depression 'a' from above)	3.00	3.00	inches
Number of Unit Inlets (Grate or Curb Opening)	1	1	
Water Depth at Flowline (outside of local depression)	5.1	7.8	inches
<b>Grate Information</b>			
Length of a Unit Grate	N/A	N/A	feet
Width of a Unit Grate	N/A	N/A	feet
Area Opening Ratio for a Grate (typical values 0.15-0.90)	N/A	N/A	
Clogging Factor for a Single Grate (typical value 0.50 - 0.70)	N/A	N/A	
Grate Weir Coefficient (typical value 2.15 - 3.60)	N/A	N/A	
Grate Orifice Coefficient (typical value 0.60 - 0.80)	N/A	N/A	
<b>Curb Opening Information</b>			
Length of a Unit Curb Opening	10.00	10.00	feet
Height of Vertical Curb Opening in Inches	6.00	6.00	inches
Height of Curb Orifice Throat in Inches	6.00	6.00	inches
Angle of Throat (see USDCM Figure ST-5)	63.40	63.40	degrees
Side Width for Depression Pan (typically the gutter width of 2 feet)	2.00	2.00	feet
Clogging Factor for a Single Curb Opening (typical value 0.10)	0.10	0.10	
Curb Opening Weir Coefficient (typical value 2.3-3.7)	3.60	3.60	
Curb Opening Orifice Coefficient (typical value 0.60 - 0.70)	0.67	0.67	
<b>Low Head Performance Reduction (Calculated)</b>			
Depth for Grate Midwidth	N/A	N/A	ft
Depth for Curb Opening Weir Equation	0.26	0.48	ft
Combination Inlet Performance Reduction Factor for Long Inlets	0.48	0.74	
Curb Opening Performance Reduction Factor for Long Inlets	0.88	1.00	
Grated Inlet Performance Reduction Factor for Long Inlets	N/A	N/A	
<b>Total Inlet Interception Capacity (assumes clogged condition)</b>			
<span style="color: red;">Inlet Capacity IS GOOD for Minor and Major Storms(&gt;Q PEAK)</span>	5.3	15.5	cfs
Q <sub>PEAK REQUIRED</sub>	2.8	11.4	cfs

**ALLOWABLE CAPACITY FOR ONE-HALF OF STREET (Minor & Major Storm)**

(Based on Regulated Criteria for Maximum Allowable Flow Depth and Spread)

Project: \_\_\_\_\_ Enter Your Project Name Here  
 Inlet ID: \_\_\_\_\_ DP-14 INLET



**Gutter Geometry (Enter data in the blue cells)**

Maximum Allowable Width for Spread Behind Curb  
 Side Slope Behind Curb (leave blank for no conveyance credit behind curb)  
 Manning's Roughness Behind Curb (typically between 0.012 and 0.020)  
 Height of Curb at Gutter Flow Line  
 Distance from Curb Face to Street Crown  
 Gutter Width  
 Street Transverse Slope  
 Gutter Cross Slope (typically 2 inches over 24 inches or 0.083 ft/ft)  
 Street Longitudinal Slope - Enter 0 for sump condition  
 Manning's Roughness for Street Section (typically between 0.012 and 0.020)

$T_{BACK} =$   ft  
 $S_{BACK} =$   ft/ft  
 $n_{BACK} =$

$H_{CURB} =$   inches  
 $T_{CROWN} =$   ft  
 $W =$   ft  
 $S_X =$   ft/ft  
 $S_W =$   ft/ft  
 $S_0 =$   ft/ft  
 $n_{STREET} =$

Max. Allowable Spread for Minor & Major Storm  
 Max. Allowable Depth at Gutter Flowline for Minor & Major Storm  
 Check boxes are not applicable in SUMP conditions

	Minor Storm	Major Storm	
$T_{MAX} =$	<input type="text" value="17.0"/>	<input type="text" value="17.0"/>	ft
$d_{MAX} =$	<input type="text" value="5.1"/>	<input type="text" value="7.8"/>	inches
	<input type="checkbox"/>	<input type="checkbox"/>	

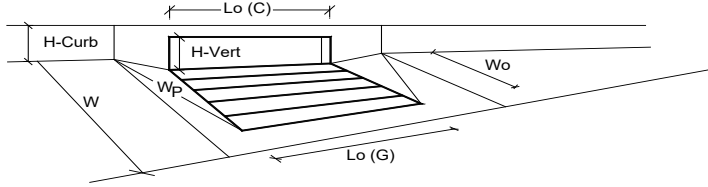
**MINOR STORM** Allowable Capacity is based on Depth Criterion  
**MAJOR STORM** Allowable Capacity is based on Depth Criterion

$Q_{allow} =$ 

Minor Storm	Major Storm	
<input type="text" value="SUMP"/>	<input type="text" value="SUMP"/>	cfs

## INLET IN A SUMP OR SAG LOCATION

Version 4.05 Released March 2017

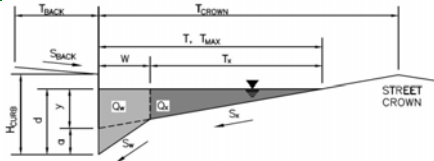


Design Information (Input)	MINOR	MAJOR	
Type of Inlet	CDOT Type R Curb Opening		
Local Depression (additional to continuous gutter depression 'a' from above)	3.00	3.00	inches
Number of Unit Inlets (Grate or Curb Opening)	1	1	
Water Depth at Flowline (outside of local depression)	5.1	7.8	inches
<b>Grate Information</b>	MINOR	MAJOR	<input checked="" type="checkbox"/> Override Depths
Length of a Unit Grate	N/A	N/A	feet
Width of a Unit Grate	N/A	N/A	feet
Area Opening Ratio for a Grate (typical values 0.15-0.90)	N/A	N/A	
Clogging Factor for a Single Grate (typical value 0.50 - 0.70)	N/A	N/A	
Grate Weir Coefficient (typical value 2.15 - 3.60)	N/A	N/A	
Grate Orifice Coefficient (typical value 0.60 - 0.80)	N/A	N/A	
<b>Curb Opening Information</b>	MINOR	MAJOR	
Length of a Unit Curb Opening	10.00	10.00	feet
Height of Vertical Curb Opening in Inches	6.00	6.00	inches
Height of Curb Orifice Throat in Inches	6.00	6.00	inches
Angle of Throat (see USDCM Figure ST-5)	63.40	63.40	degrees
Side Width for Depression Pan (typically the gutter width of 2 feet)	2.00	2.00	feet
Clogging Factor for a Single Curb Opening (typical value 0.10)	0.10	0.10	
Curb Opening Weir Coefficient (typical value 2.3-3.7)	3.60	3.60	
Curb Opening Orifice Coefficient (typical value 0.60 - 0.70)	0.67	0.67	
<b>Low Head Performance Reduction (Calculated)</b>	MINOR	MAJOR	
Depth for Grate Midwidth	N/A	N/A	ft
Depth for Curb Opening Weir Equation	0.26	0.48	ft
Combination Inlet Performance Reduction Factor for Long Inlets	0.48	0.74	
Curb Opening Performance Reduction Factor for Long Inlets	0.88	1.00	
Grated Inlet Performance Reduction Factor for Long Inlets	N/A	N/A	
<b>Total Inlet Interception Capacity (assumes clogged condition)</b>	MINOR	MAJOR	
Inlet Capacity IS GOOD for Minor and Major Storms(>Q PEAK)	5.3	15.5	cfs
Q PEAK REQUIRED =	3.3	6.6	cfs

**ALLOWABLE CAPACITY FOR ONE-HALF OF STREET (Minor & Major Storm)**

(Based on Regulated Criteria for Maximum Allowable Flow Depth and Spread)

Project: \_\_\_\_\_ Enter Your Project Name Here  
 Inlet ID: \_\_\_\_\_ DP-15 INLET



**Gutter Geometry (Enter data in the blue cells)**

Maximum Allowable Width for Spread Behind Curb  
 Side Slope Behind Curb (leave blank for no conveyance credit behind curb)  
 Manning's Roughness Behind Curb (typically between 0.012 and 0.020)  
 Height of Curb at Gutter Flow Line  
 Distance from Curb Face to Street Crown  
 Gutter Width  
 Street Transverse Slope  
 Gutter Cross Slope (typically 2 inches over 24 inches or 0.083 ft/ft)  
 Street Longitudinal Slope - Enter 0 for sump condition  
 Manning's Roughness for Street Section (typically between 0.012 and 0.020)

$T_{BACK} = 7.5$  ft  
 $S_{BACK} = 0.020$  ft/ft  
 $n_{BACK} = 0.013$   
 $H_{CURB} = 6.00$  inches  
 $T_{CROWN} = 17.0$  ft  
 $W = 2.00$  ft  
 $S_X = 0.020$  ft/ft  
 $S_W = 0.083$  ft/ft  
 $S_O = 0.000$  ft/ft  
 $n_{STREET} = 0.016$

Max. Allowable Spread for Minor & Major Storm  
 Max. Allowable Depth at Gutter Flowline for Minor & Major Storm  
 Check boxes are not applicable in SUMP conditions

	Minor Storm	Major Storm	
$T_{MAX} =$	17.0	17.0	ft
$d_{MAX} =$	5.1	7.8	inches
	<input type="checkbox"/>	<input type="checkbox"/>	

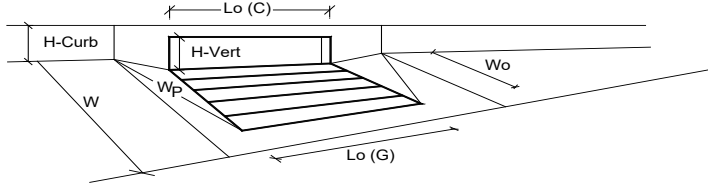
**MINOR STORM Allowable Capacity is based on Depth Criterion**  
**MAJOR STORM Allowable Capacity is based on Depth Criterion**

$Q_{allow} =$ 

Minor Storm	Major Storm	
SUMP	SUMP	cfs

## INLET IN A SUMP OR SAG LOCATION

Version 4.05 Released March 2017

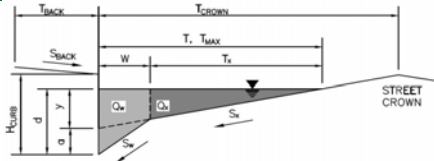


Design Information (Input)	MINOR	MAJOR	
Type of Inlet	CDOT Type R Curb Opening		
Local Depression (additional to continuous gutter depression 'a' from above)	3.00	3.00	inches
Number of Unit Inlets (Grate or Curb Opening)	1	1	
Water Depth at Flowline (outside of local depression)	5.1	7.8	inches
<b>Grate Information</b>	MINOR	MAJOR	<input checked="" type="checkbox"/> Override Depths
Length of a Unit Grate	N/A	N/A	feet
Width of a Unit Grate	N/A	N/A	feet
Area Opening Ratio for a Grate (typical values 0.15-0.90)	N/A	N/A	
Clogging Factor for a Single Grate (typical value 0.50 - 0.70)	N/A	N/A	
Grate Weir Coefficient (typical value 2.15 - 3.60)	N/A	N/A	
Grate Orifice Coefficient (typical value 0.60 - 0.80)	N/A	N/A	
<b>Curb Opening Information</b>	MINOR	MAJOR	
Length of a Unit Curb Opening	5.00	5.00	feet
Height of Vertical Curb Opening in Inches	6.00	6.00	inches
Height of Curb Orifice Throat in Inches	6.00	6.00	inches
Angle of Throat (see USDCM Figure ST-5)	63.40	63.40	degrees
Side Width for Depression Pan (typically the gutter width of 2 feet)	2.00	2.00	feet
Clogging Factor for a Single Curb Opening (typical value 0.10)	0.10	0.10	
Curb Opening Weir Coefficient (typical value 2.3-3.7)	3.60	3.60	
Curb Opening Orifice Coefficient (typical value 0.60 - 0.70)	0.67	0.67	
<b>Low Head Performance Reduction (Calculated)</b>	MINOR	MAJOR	
Depth for Grate Midwidth	N/A	N/A	ft
Depth for Curb Opening Weir Equation	0.26	0.48	ft
Combination Inlet Performance Reduction Factor for Long Inlets	0.65	1.00	
Curb Opening Performance Reduction Factor for Long Inlets	1.00	1.00	
Grated Inlet Performance Reduction Factor for Long Inlets	N/A	N/A	
<b>Total Inlet Interception Capacity (assumes clogged condition)</b>	MINOR	MAJOR	
Inlet Capacity IS GOOD for Minor and Major Storms(>Q PEAK)	3.7	9.0	cfs
Q <sub>PEAK REQUIRED</sub>	3.2	6.5	cfs

**ALLOWABLE CAPACITY FOR ONE-HALF OF STREET (Minor & Major Storm)**

(Based on Regulated Criteria for Maximum Allowable Flow Depth and Spread)

Project: \_\_\_\_\_ Enter Your Project Name Here  
 Inlet ID: \_\_\_\_\_ DP-16 INLET



**Gutter Geometry (Enter data in the blue cells)**

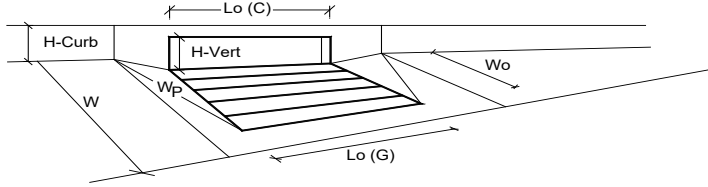
Maximum Allowable Width for Spread Behind Curb  
 Side Slope Behind Curb (leave blank for no conveyance credit behind curb)  
 Manning's Roughness Behind Curb (typically between 0.012 and 0.020)  
 Height of Curb at Gutter Flow Line  
 Distance from Curb Face to Street Crown  
 Gutter Width  
 Street Transverse Slope  
 Gutter Cross Slope (typically 2 inches over 24 inches or 0.083 ft/ft)  
 Street Longitudinal Slope - Enter 0 for sump condition  
 Manning's Roughness for Street Section (typically between 0.012 and 0.020)

$T_{BACK}$ =	7.5	ft
$S_{BACK}$ =	0.020	ft/ft
$n_{BACK}$ =	0.013	
$H_{CURB}$ =	6.00	inches
$T_{CROWN}$ =	17.0	ft
$W$ =	2.00	ft
$S_x$ =	0.020	ft/ft
$S_w$ =	0.083	ft/ft
$S_o$ =	0.000	ft/ft
$n_{STREET}$ =	0.016	
$T_{MAX}$ =	Minor Storm: 17.0 Major Storm: 17.0	ft
$d_{MAX}$ =	Minor Storm: 5.1 Major Storm: 7.8	inches
	<input type="checkbox"/> <input type="checkbox"/>	
$Q_{allow}$ =	Minor Storm: SUMP Major Storm: SUMP	cfs

Max. Allowable Spread for Minor & Major Storm  
 Max. Allowable Depth at Gutter Flowline for Minor & Major Storm  
 Check boxes are not applicable in SUMP conditions  
**MINOR STORM Allowable Capacity is based on Depth Criterion**  
**MAJOR STORM Allowable Capacity is based on Depth Criterion**

## INLET IN A SUMP OR SAG LOCATION

Version 4.05 Released March 2017



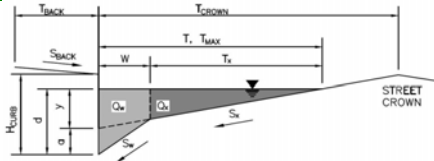
Design Information (Input)	MINOR	MAJOR	
Type of Inlet	CDOT Type R Curb Opening		
Local Depression (additional to continuous gutter depression 'a' from above)	3.00	3.00	inches
Number of Unit Inlets (Grate or Curb Opening)	1	1	
Water Depth at Flowline (outside of local depression)	5.1	7.8	inches
<b>Grate Information</b>	MINOR	MAJOR	<input checked="" type="checkbox"/> Override Depths
Length of a Unit Grate	N/A	N/A	feet
Width of a Unit Grate	N/A	N/A	feet
Area Opening Ratio for a Grate (typical values 0.15-0.90)	N/A	N/A	
Clogging Factor for a Single Grate (typical value 0.50 - 0.70)	N/A	N/A	
Grate Weir Coefficient (typical value 2.15 - 3.60)	N/A	N/A	
Grate Orifice Coefficient (typical value 0.60 - 0.80)	N/A	N/A	
<b>Curb Opening Information</b>	MINOR	MAJOR	
Length of a Unit Curb Opening	5.00	5.00	feet
Height of Vertical Curb Opening in Inches	6.00	6.00	inches
Height of Curb Orifice Throat in Inches	6.00	6.00	inches
Angle of Throat (see USDCM Figure ST-5)	63.40	63.40	degrees
Side Width for Depression Pan (typically the gutter width of 2 feet)	2.00	2.00	feet
Clogging Factor for a Single Curb Opening (typical value 0.10)	0.10	0.10	
Curb Opening Weir Coefficient (typical value 2.3-3.7)	3.60	3.60	
Curb Opening Orifice Coefficient (typical value 0.60 - 0.70)	0.67	0.67	
<b>Low Head Performance Reduction (Calculated)</b>	MINOR	MAJOR	
Depth for Grate Midwidth	N/A	N/A	ft
Depth for Curb Opening Weir Equation	0.26	0.48	ft
Combination Inlet Performance Reduction Factor for Long Inlets	0.65	1.00	
Curb Opening Performance Reduction Factor for Long Inlets	1.00	1.00	
Grated Inlet Performance Reduction Factor for Long Inlets	N/A	N/A	
<b>Total Inlet Interception Capacity (assumes clogged condition)</b>	MINOR	MAJOR	
Inlet Capacity IS GOOD for Minor and Major Storms(>Q PEAK)	3.7	9.0	cfs
Q <sub>PEAK REQUIRED</sub>	1.2	2.4	cfs



**ALLOWABLE CAPACITY FOR ONE-HALF OF STREET (Minor & Major Storm)**

(Based on Regulated Criteria for Maximum Allowable Flow Depth and Spread)

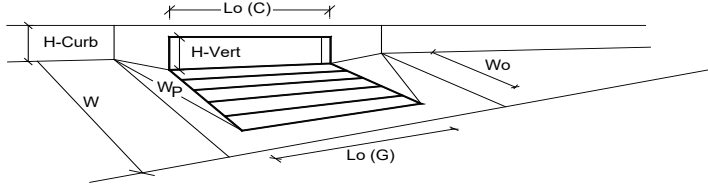
Project: \_\_\_\_\_ Enter Your Project Name Here  
 Inlet ID: \_\_\_\_\_ DP-17 INLET



Gutter Geometry (Enter data in the blue cells)					
Maximum Allowable Width for Spread Behind Curb	$T_{BACK} = 7.5$ ft				
Side Slope Behind Curb (leave blank for no conveyance credit behind curb)	$S_{BACK} = 0.020$ ft/ft				
Manning's Roughness Behind Curb (typically between 0.012 and 0.020)	$n_{BACK} = 0.013$				
Height of Curb at Gutter Flow Line	$H_{CURB} = 6.00$ inches				
Distance from Curb Face to Street Crown	$T_{CROWN} = 17.0$ ft				
Gutter Width	$W = 2.00$ ft				
Street Transverse Slope	$S_x = 0.020$ ft/ft				
Gutter Cross Slope (typically 2 inches over 24 inches or 0.083 ft/ft)	$S_w = 0.083$ ft/ft				
Street Longitudinal Slope - Enter 0 for sump condition	$S_o = 0.000$ ft/ft				
Manning's Roughness for Street Section (typically between 0.012 and 0.020)	$n_{STREET} = 0.016$				
Max. Allowable Spread for Minor & Major Storm	<table border="1" style="display: inline-table; border-collapse: collapse;"> <tr> <th style="width: 50%;">Minor Storm</th> <th style="width: 50%;">Major Storm</th> </tr> <tr> <td><math>T_{MAX} = 17.0</math></td> <td><math>T_{MAX} = 17.0</math></td> </tr> </table> ft	Minor Storm	Major Storm	$T_{MAX} = 17.0$	$T_{MAX} = 17.0$
Minor Storm	Major Storm				
$T_{MAX} = 17.0$	$T_{MAX} = 17.0$				
Max. Allowable Depth at Gutter Flowline for Minor & Major Storm	<table border="1" style="display: inline-table; border-collapse: collapse;"> <tr> <th style="width: 50%;">Minor Storm</th> <th style="width: 50%;">Major Storm</th> </tr> <tr> <td><math>d_{MAX} = 5.1</math></td> <td><math>d_{MAX} = 7.8</math></td> </tr> </table> inches	Minor Storm	Major Storm	$d_{MAX} = 5.1$	$d_{MAX} = 7.8$
Minor Storm	Major Storm				
$d_{MAX} = 5.1$	$d_{MAX} = 7.8$				
Check boxes are not applicable in SUMP conditions	<input type="checkbox"/> <input type="checkbox"/>				
<b>MINOR STORM Allowable Capacity is based on Depth Criterion</b>					
<b>MAJOR STORM Allowable Capacity is based on Depth Criterion</b>					
MINOR STORM Allowable Capacity is based on Depth Criterion	<table border="1" style="display: inline-table; border-collapse: collapse;"> <tr> <th style="width: 50%;">Minor Storm</th> <th style="width: 50%;">Major Storm</th> </tr> <tr> <td><math>Q_{allow} = \text{SUMP}</math></td> <td><math>Q_{allow} = \text{SUMP}</math></td> </tr> </table> cfs	Minor Storm	Major Storm	$Q_{allow} = \text{SUMP}$	$Q_{allow} = \text{SUMP}$
Minor Storm	Major Storm				
$Q_{allow} = \text{SUMP}$	$Q_{allow} = \text{SUMP}$				
MAJOR STORM Allowable Capacity is based on Depth Criterion					

## INLET IN A SUMP OR SAG LOCATION

Version 4.05 Released March 2017

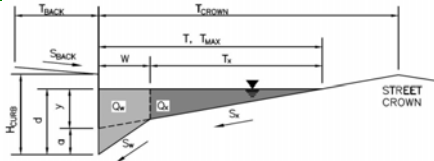


Design Information (Input)	MINOR	MAJOR	
Type of Inlet	CDOT Type R Curb Opening		
Local Depression (additional to continuous gutter depression 'a' from above)	3.00	3.00	inches
Number of Unit Inlets (Grate or Curb Opening)	1	1	
Water Depth at Flowline (outside of local depression)	5.3	7.8	inches
<b>Grate Information</b>	MINOR	MAJOR	<input checked="" type="checkbox"/> Override Depths
Length of a Unit Grate	N/A	N/A	feet
Width of a Unit Grate	N/A	N/A	feet
Area Opening Ratio for a Grate (typical values 0.15-0.90)	N/A	N/A	
Clogging Factor for a Single Grate (typical value 0.50 - 0.70)	N/A	N/A	
Grate Weir Coefficient (typical value 2.15 - 3.60)	N/A	N/A	
Grate Orifice Coefficient (typical value 0.60 - 0.80)	N/A	N/A	
<b>Curb Opening Information</b>	MINOR	MAJOR	
Length of a Unit Curb Opening	15.00	15.00	feet
Height of Vertical Curb Opening in Inches	6.00	6.00	inches
Height of Curb Orifice Throat in Inches	6.00	6.00	inches
Angle of Throat (see USDCM Figure ST-5)	63.40	63.40	degrees
Side Width for Depression Pan (typically the gutter width of 2 feet)	2.00	2.00	feet
Clogging Factor for a Single Curb Opening (typical value 0.10)	0.10	0.10	
Curb Opening Weir Coefficient (typical value 2.3-3.7)	3.60	3.60	
Curb Opening Orifice Coefficient (typical value 0.60 - 0.70)	0.67	0.67	
<b>Low Head Performance Reduction (Calculated)</b>	MINOR	MAJOR	
Depth for Grate Midwidth	N/A	N/A	ft
Depth for Curb Opening Weir Equation	0.28	0.48	ft
Combination Inlet Performance Reduction Factor for Long Inlets	0.50	0.74	
Curb Opening Performance Reduction Factor for Long Inlets	0.74	0.88	
Grated Inlet Performance Reduction Factor for Long Inlets	N/A	N/A	
<b>Total Inlet Interception Capacity (assumes clogged condition)</b>	MINOR	MAJOR	
Inlet Capacity IS GOOD for Minor and Major Storms(>Q PEAK)	6.9	19.1	cfs
Q PEAK REQUIRED =	6.8	15.1	cfs

**ALLOWABLE CAPACITY FOR ONE-HALF OF STREET (Minor & Major Storm)**

(Based on Regulated Criteria for Maximum Allowable Flow Depth and Spread)

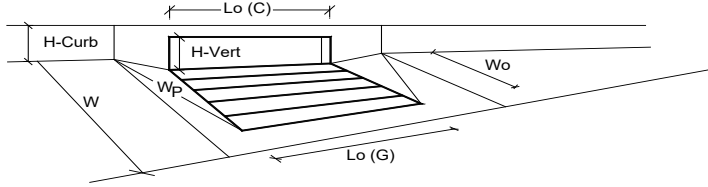
Project: \_\_\_\_\_ Enter Your Project Name Here  
 Inlet ID: \_\_\_\_\_ DP-18 INLET



Gutter Geometry (Enter data in the blue cells)									
Maximum Allowable Width for Spread Behind Curb	$T_{BACK} = 17.0$ ft								
Side Slope Behind Curb (leave blank for no conveyance credit behind curb)	$S_{BACK} = 0.020$ ft/ft								
Manning's Roughness Behind Curb (typically between 0.012 and 0.020)	$n_{BACK} = 0.013$								
Height of Curb at Gutter Flow Line	$H_{CURB} = 6.00$ inches								
Distance from Curb Face to Street Crown	$T_{CROWN} = 17.0$ ft								
Gutter Width	$W = 2.00$ ft								
Street Transverse Slope	$S_x = 0.020$ ft/ft								
Gutter Cross Slope (typically 2 inches over 24 inches or 0.083 ft/ft)	$S_w = 0.083$ ft/ft								
Street Longitudinal Slope - Enter 0 for sump condition	$S_o = 0.000$ ft/ft								
Manning's Roughness for Street Section (typically between 0.012 and 0.020)	$n_{STREET} = 0.016$								
Max. Allowable Spread for Minor & Major Storm	<table border="1"> <tr> <th></th> <th>Minor Storm</th> <th>Major Storm</th> <th></th> </tr> <tr> <td><math>T_{MAX} =</math></td> <td>17.0</td> <td>17.0</td> <td>ft</td> </tr> </table>		Minor Storm	Major Storm		$T_{MAX} =$	17.0	17.0	ft
	Minor Storm	Major Storm							
$T_{MAX} =$	17.0	17.0	ft						
Max. Allowable Depth at Gutter Flowline for Minor & Major Storm	<table border="1"> <tr> <th></th> <th>Minor Storm</th> <th>Major Storm</th> <th></th> </tr> <tr> <td><math>d_{MAX} =</math></td> <td>5.1</td> <td>7.8</td> <td>inches</td> </tr> </table>		Minor Storm	Major Storm		$d_{MAX} =$	5.1	7.8	inches
	Minor Storm	Major Storm							
$d_{MAX} =$	5.1	7.8	inches						
Check boxes are not applicable in SUMP conditions	<input type="checkbox"/> <input type="checkbox"/>								
<b>MINOR STORM Allowable Capacity is based on Depth Criterion</b>									
<b>MAJOR STORM Allowable Capacity is based on Depth Criterion</b>									
MINOR STORM Allowable Capacity is based on Depth Criterion	<table border="1"> <tr> <th></th> <th>Minor Storm</th> <th>Major Storm</th> <th></th> </tr> <tr> <td><math>Q_{allow} =</math></td> <td>SUMP</td> <td>SUMP</td> <td>cfs</td> </tr> </table>		Minor Storm	Major Storm		$Q_{allow} =$	SUMP	SUMP	cfs
	Minor Storm	Major Storm							
$Q_{allow} =$	SUMP	SUMP	cfs						

## INLET IN A SUMP OR SAG LOCATION

Version 4.05 Released March 2017

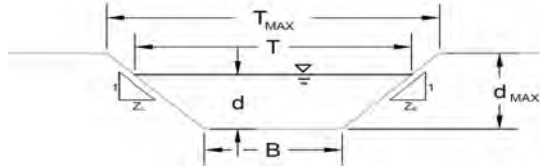


Design Information (Input)	MINOR	MAJOR	
Type of Inlet	CDOT Type R Curb Opening		
Local Depression (additional to continuous gutter depression 'a' from above)	3.00	3.00	inches
Number of Unit Inlets (Grate or Curb Opening)	1	1	
Water Depth at Flowline (outside of local depression)	5.1	7.8	inches
<b>Grate Information</b>	MINOR	MAJOR	<input checked="" type="checkbox"/> Override Depths
Length of a Unit Grate	N/A	N/A	feet
Width of a Unit Grate	N/A	N/A	feet
Area Opening Ratio for a Grate (typical values 0.15-0.90)	N/A	N/A	
Clogging Factor for a Single Grate (typical value 0.50 - 0.70)	N/A	N/A	
Grate Weir Coefficient (typical value 2.15 - 3.60)	N/A	N/A	
Grate Orifice Coefficient (typical value 0.60 - 0.80)	N/A	N/A	
<b>Curb Opening Information</b>	MINOR	MAJOR	
Length of a Unit Curb Opening	10.00	10.00	feet
Height of Vertical Curb Opening in Inches	6.00	6.00	inches
Height of Curb Orifice Throat in Inches	6.00	6.00	inches
Angle of Throat (see USDCM Figure ST-5)	63.40	63.40	degrees
Side Width for Depression Pan (typically the gutter width of 2 feet)	2.00	2.00	feet
Clogging Factor for a Single Curb Opening (typical value 0.10)	0.10	0.10	
Curb Opening Weir Coefficient (typical value 2.3-3.7)	3.60	3.60	
Curb Opening Orifice Coefficient (typical value 0.60 - 0.70)	0.67	0.67	
<b>Low Head Performance Reduction (Calculated)</b>	MINOR	MAJOR	
Depth for Grate Midwidth	N/A	N/A	ft
Depth for Curb Opening Weir Equation	0.26	0.48	ft
Combination Inlet Performance Reduction Factor for Long Inlets	0.48	0.74	
Curb Opening Performance Reduction Factor for Long Inlets	0.88	1.00	
Grated Inlet Performance Reduction Factor for Long Inlets	N/A	N/A	
<b>Total Inlet Interception Capacity (assumes clogged condition)</b>	MINOR	MAJOR	
Inlet Capacity IS GOOD for Minor and Major Storms(>Q PEAK)	5.3	15.5	cfs
Q <sub>PEAK REQUIRED</sub>	4.1	8.2	cfs

**AREA INLET IN A SWALE**

Enter Your Project Name Here

DP-21 INLET



This worksheet uses the NRCS vegetative retardance method to determine Manning's n.  
For more information see Section 7.2.3 of the USDCM.

**Analysis of Trapezoidal Grass-Lined Channel Using SCS Method**

NRCS Vegetal Retardance (A, B, C, D, or E)  
Manning's n (Leave cell D16 blank to manually enter an n value)  
Channel Invert Slope  
Bottom Width  
Left Side Slope  
Right Side Slope

A, B, C, D or E  
n = 0.040  
S<sub>0</sub> = 0.0300 ft/ft  
B = 2.00 ft  
Z1 = 4.00 ft/ft  
Z2 = 3.00 ft/ft

Check one of the following soil types:

Soil Type:	Max. Velocity (V <sub>MAX</sub> )	Max Froude No. (F <sub>MAX</sub> )
Non-Cohesive	5.0 fps	0.60
Cohesive	7.0 fps	0.80
Paved	N/A	N/A

Choose One:  
 Non-Cohesive  
 Cohesive  
 Paved

Max. Allowable Top Width of Channel for Minor & Major Storm  
Max. Allowable Water Depth in Channel for Minor & Major Storm

	Minor Storm	Major Storm	
T <sub>MAX</sub> =	13.50	13.50	feet
d <sub>MAX</sub> =	1.50	1.50	feet

**Allowable Channel Capacity Based On Channel Geometry**

MINOR STORM Allowable Capacity is based on Depth Criterion  
MAJOR STORM Allowable Capacity is based on Depth Criterion

	Minor Storm	Major Storm	
Q <sub>allow</sub> =	62.5	62.5	cfs
d <sub>allow</sub> =	1.50	1.50	ft

**Water Depth in Channel Based On Design Peak Flow**

Design Peak Flow  
Water Depth

	Minor Storm	Major Storm	
Q <sub>c</sub> =	7.7	51.9	cfs
d =	0.57	1.38	feet

Minor storm max. allowable capacity GOOD - greater than the design flow given on sheet 'Inlet Management'  
Major storm max. allowable capacity GOOD - greater than the design flow given on sheet 'Inlet Management'

AREA INLET IN A SWALE

Enter Your Project Name Here

DP-21 INLET

**Inlet Design Information (Input)**

Type of Inlet:  Inlet Type =

Angle of Inclined Grate (must be <= 30 degrees):  degrees

Width of Grate:  feet

Length of Grate:  feet

Open Area Ratio:

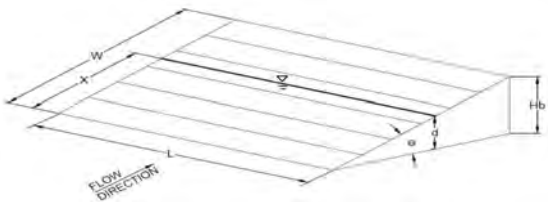
Height of Inclined Grate:  feet

Clogging Factor:

Grate Discharge Coefficient:

Orifice Coefficient:

Weir Coefficient:



	MINOR	MAJOR	
d =	1.57	2.38	
<b>Q<sub>a</sub> =</b>	<b>37.8</b>	<b>46.5</b>	<b>cfs</b>
Bypassed Flow, Q <sub>b</sub> =	0.0	5.4	cfs
Capture Percentage = Q <sub>a</sub> /Q <sub>o</sub> = C%	100	90	%

Water Depth at Inlet (for depressed inlets, 1 foot is added for depression)

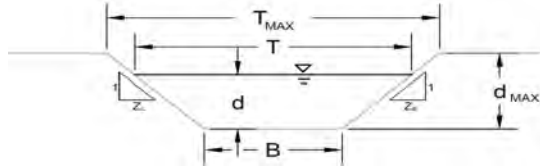
**Total Inlet Interception Capacity (assumes clogged condition)**

Warning 03: Velocity exceeds USDCM Volume I recommendation.  
 Warning 04: Froude No. exceeds USDCM Volume I recommendation.

**AREA INLET IN A SWALE**

Enter Your Project Name Here

DP-22 INLET



This worksheet uses the NRCS vegetative retardance method to determine Manning's n.

For more information see Section 7.2.3 of the USDCM.

**Analysis of Trapezoidal Grass-Lined Channel Using SCS Method**

NRCS Vegetal Retardance (A, B, C, D, or E)  
 Manning's n (Leave cell D16 blank to manually enter an n value)  
 Channel Invert Slope  
 Bottom Width  
 Left Side Slope  
 Right Side Slope

A, B, C, D or E  
 n = 0.040  
 S<sub>0</sub> = 0.0400 ft/ft  
 B = 2.00 ft  
 Z1 = 4.00 ft/ft  
 Z2 = 3.00 ft/ft

Check one of the following soil types:

Soil Type:	Max. Velocity (V <sub>MAX</sub> )	Max Froude No. (F <sub>MAX</sub> )
Non-Cohesive	5.0 fps	0.60
Cohesive	7.0 fps	0.80
Paved	N/A	N/A

Choose One:  
 Non-Cohesive  
 Cohesive  
 Paved

Max. Allowable Top Width of Channel for Minor & Major Storm  
 Max. Allowable Water Depth in Channel for Minor & Major Storm

	Minor Storm	Major Storm	
T <sub>MAX</sub> =	13.50	13.50	feet
d <sub>MAX</sub> =	1.50	1.50	feet

**Allowable Channel Capacity Based On Channel Geometry**

MINOR STORM Allowable Capacity is based on Depth Criterion  
 MAJOR STORM Allowable Capacity is based on Depth Criterion

	Minor Storm	Major Storm	
Q <sub>allow</sub> =	72.2	72.2	cfs
d <sub>allow</sub> =	1.50	1.50	ft

**Water Depth in Channel Based On Design Peak Flow**

Design Peak Flow  
 Water Depth

	Minor Storm	Major Storm	
Q <sub>o</sub> =	8.2	60.6	cfs
d =	0.55	1.39	feet

Minor storm max. allowable capacity GOOD - greater than the design flow given on sheet 'Inlet Management'  
 Major storm max. allowable capacity GOOD - greater than the design flow given on sheet 'Inlet Management'

AREA INLET IN A SWALE

Enter Your Project Name Here

DP-22 INLET

**Inlet Design Information (Input)**

Type of Inlet:  Inlet Type =

Angle of Inclined Grate (must be <= 30 degrees):  degrees

Width of Grate:  feet

Length of Grate:  feet

Open Area Ratio:

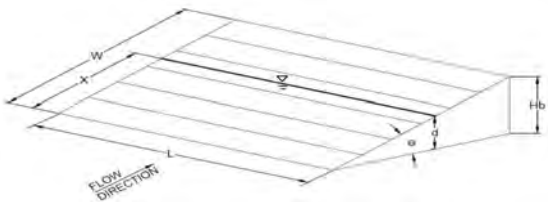
Height of Inclined Grate:  feet

Clogging Factor:

Grate Discharge Coefficient:

Orifice Coefficient:

Weir Coefficient:



Water Depth at Inlet (for depressed inlets, 1 foot is added for depression):  MINOR

	MINOR	MAJOR	
d =	1.55	2.39	
<b>Q<sub>a</sub> =</b>	<b>37.6</b>	<b>46.6</b>	<b>cfs</b>
Bypassed Flow, Q <sub>b</sub> =	0.0	14.0	cfs
Capture Percentage = Q <sub>a</sub> /Q <sub>o</sub> = C%	100	77	%

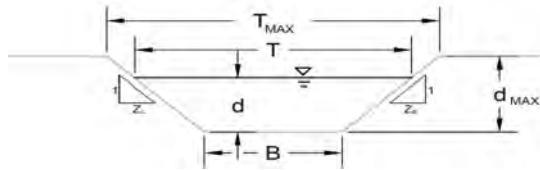
Warning 03: Velocity exceeds USDCM Volume I recommendation.  
 Warning 04: Froude No. exceeds USDCM Volume I recommendation.



**AREA INLET IN A SWALE**

Enter Your Project Name Here

DP-23 INLET



This worksheet uses the NRCS vegetative retardance method to determine Manning's n.

For more information see Section 7.2.3 of the USDCM.

**Analysis of Trapezoidal Grass-Lined Channel Using SCS Method**

NRCS Vegetal Retardance (A, B, C, D, or E)  
 Manning's n (Leave cell D16 blank to manually enter an n value)  
 Channel Invert Slope  
 Bottom Width  
 Left Side Slope  
 Right Side Slope

A, B, C, D or E  
 n = 0.040  
 S<sub>0</sub> = 0.0300 ft/ft  
 B = 2.00 ft  
 Z1 = 4.00 ft/ft  
 Z2 = 3.00 ft/ft

Check one of the following soil types:

Soil Type:	Max. Velocity (V <sub>MAX</sub> )	Max Froude No. (F <sub>MAX</sub> )
Non-Cohesive	5.0 fps	0.60
Cohesive	7.0 fps	0.80
Paved	N/A	N/A

Choose One:  
 Non-Cohesive  
 Cohesive  
 Paved

Max. Allowable Top Width of Channel for Minor & Major Storm  
 Max. Allowable Water Depth in Channel for Minor & Major Storm

	Minor Storm	Major Storm	
T <sub>MAX</sub> =	13.50	13.50	feet
d <sub>MAX</sub> =	1.50	1.50	feet

**Allowable Channel Capacity Based On Channel Geometry**

MINOR STORM Allowable Capacity is based on Depth Criterion  
 MAJOR STORM Allowable Capacity is based on Depth Criterion

	Minor Storm	Major Storm	
Q <sub>allow</sub> =	62.5	62.5	cfs
d <sub>allow</sub> =	1.50	1.50	ft

**Water Depth in Channel Based On Design Peak Flow**

Design Peak Flow  
 Water Depth

	Minor Storm	Major Storm	
Q <sub>c</sub> =	3.4	36.5	cfs
d =	0.38	1.18	feet

Minor storm max. allowable capacity GOOD - greater than the design flow given on sheet 'Inlet Management'  
 Major storm max. allowable capacity GOOD - greater than the design flow given on sheet 'Inlet Management'

AREA INLET IN A SWALE

Enter Your Project Name Here

DP-23 INLET

**Inlet Design Information (Input)**

Type of Inlet:  Inlet Type =

Angle of Inclined Grate (must be <= 30 degrees)  $\theta = 0.00$  degrees

Width of Grate  $W = 3.00$  feet

Length of Grate  $L = 6.00$  feet

Open Area Ratio  $A_{RATIO} = 0.70$

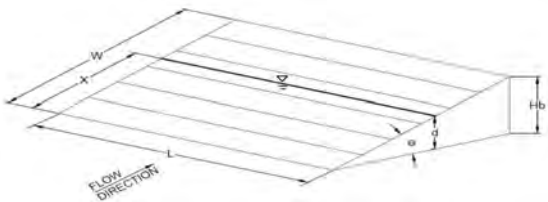
Height of Inclined Grate  $H_B = 0.00$  feet

Clogging Factor  $C_f = 0.38$

Grate Discharge Coefficient  $C_d = 0.78$

Orifice Coefficient  $C_o = 0.52$

Weir Coefficient  $C_w = 1.67$



Water Depth at Inlet (for depressed inlets, 1 foot is added for depression)  $d = 0.38$  MINOR

**Total Inlet Interception Capacity (assumes clogged condition)**

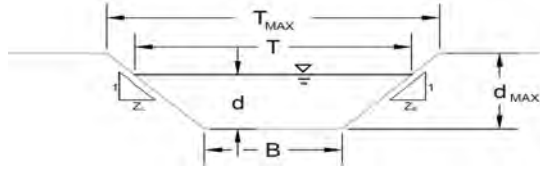
	MINOR	MAJOR	
$Q_a =$	7.0	35.8	cfs
Bypassed Flow, $Q_b =$	0.0	0.7	cfs
Capture Percentage = $Q_a/Q_o =$ C%	100	98	%

Warning 04: Froude No. exceeds USDCM Volume I recommendation.

**AREA INLET IN A SWALE**

Enter Your Project Name Here

DP-24 INLET



This worksheet uses the NRCS vegetative retardance method to determine Manning's n.  
For more information see Section 7.2.3 of the USDCM.

**Analysis of Trapezoidal Grass-Lined Channel Using SCS Method**

NRCS Vegetal Retardance (A, B, C, D, or E)  
Manning's n (Leave cell D16 blank to manually enter an n value)  
Channel Invert Slope  
Bottom Width  
Left Side Slope  
Right Side Slope

A, B, C, D or E  
n = 0.040  
S<sub>0</sub> = 0.0300 ft/ft  
B = 2.00 ft  
Z1 = 3.00 ft/ft  
Z2 = 4.00 ft/ft

Check one of the following soil types:

Soil Type:	Max. Velocity (V <sub>MAX</sub> )	Max Froude No. (F <sub>MAX</sub> )
Non-Cohesive	5.0 fps	0.60
Cohesive	7.0 fps	0.80
Paved	N/A	N/A

Choose One:  
 Non-Cohesive  
 Cohesive  
 Paved

Max. Allowable Top Width of Channel for Minor & Major Storm  
Max. Allowable Water Depth in Channel for Minor & Major Storm

	Minor Storm	Major Storm	
T <sub>MAX</sub> =	13.50	13.50	feet
d <sub>MAX</sub> =	1.50	1.50	feet

**Allowable Channel Capacity Based On Channel Geometry**

MINOR STORM Allowable Capacity is based on Depth Criterion  
MAJOR STORM Allowable Capacity is based on Depth Criterion

	Minor Storm	Major Storm	
Q <sub>allow</sub> =	62.5	62.5	cfs
d <sub>allow</sub> =	1.50	1.50	ft

**Water Depth in Channel Based On Design Peak Flow**

Design Peak Flow  
Water Depth

	Minor Storm	Major Storm	
Q <sub>c</sub> =	2.3	16.6	cfs
d =	0.31	0.83	feet

Minor storm max. allowable capacity GOOD - greater than the design flow given on sheet 'Inlet Management'  
Major storm max. allowable capacity GOOD - greater than the design flow given on sheet 'Inlet Management'

AREA INLET IN A SWALE

Enter Your Project Name Here

DP-24 INLET

**Inlet Design Information (Input)**

Type of Inlet:  Inlet Type =

Angle of Inclined Grate (must be <= 30 degrees)  $\theta = 0.00$  degrees

Width of Grate  $W = 3.00$  feet

Length of Grate  $L = 3.00$  feet

Open Area Ratio  $A_{RATIO} = 0.70$

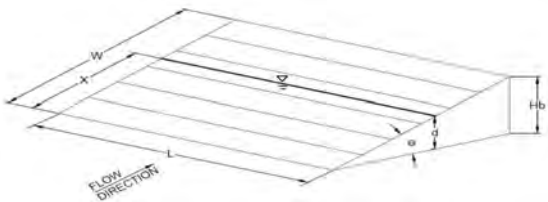
Height of Inclined Grate  $H_B = 0.00$  feet

Clogging Factor  $C_f = 0.50$

Grate Discharge Coefficient  $C_d = 0.84$

Orifice Coefficient  $C_o = 0.56$

Weir Coefficient  $C_w = 1.81$



Water Depth at Inlet (for depressed inlets, 1 foot is added for depression)

	MINOR	MAJOR	
$d =$	1.31	1.83	
$Q_a =$	16.3	19.2	cfs
Bypassed Flow, $Q_b =$	0.0	0.0	cfs
Capture Percentage = $Q_a/Q_o =$ C%	100	100	%

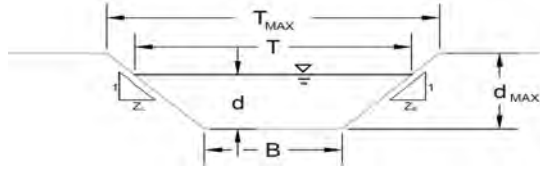
**Total Inlet Interception Capacity (assumes clogged condition)**

Warning 04: Froude No. exceeds USDCM Volume I recommendation.

**AREA INLET IN A SWALE**

Enter Your Project Name Here

DP-25 INLET



This worksheet uses the NRCS vegetative retardance method to determine Manning's n.  
For more information see Section 7.2.3 of the USDCM.

**Analysis of Trapezoidal Grass-Lined Channel Using SCS Method**

NRCS Vegetal Retardance (A, B, C, D, or E)  
Manning's n (Leave cell D16 blank to manually enter an n value)  
Channel Invert Slope  
Bottom Width  
Left Side Slope  
Right Side Slope

A, B, C, D or E  
n = 0.040  
S<sub>0</sub> = 0.0300 ft/ft  
B = 2.00 ft  
Z1 = 4.00 ft/ft  
Z2 = 3.00 ft/ft

Check one of the following soil types:

Soil Type:	Max. Velocity (V <sub>MAX</sub> )	Max Froude No. (F <sub>MAX</sub> )
Non-Cohesive	5.0 fps	0.60
Cohesive	7.0 fps	0.80
Paved	N/A	N/A

Choose One:  
 Non-Cohesive  
 Cohesive  
 Paved

Max. Allowable Top Width of Channel for Minor & Major Storm  
Max. Allowable Water Depth in Channel for Minor & Major Storm

	Minor Storm	Major Storm	
T <sub>MAX</sub> =	13.50	13.50	feet
d <sub>MAX</sub> =	1.50	1.50	feet

**Allowable Channel Capacity Based On Channel Geometry**

MINOR STORM Allowable Capacity is based on Depth Criterion  
MAJOR STORM Allowable Capacity is based on Depth Criterion

	Minor Storm	Major Storm	
Q <sub>allow</sub> =	62.5	62.5	cfs
d <sub>allow</sub> =	1.50	1.50	ft

**Water Depth in Channel Based On Design Peak Flow**

Design Peak Flow  
Water Depth

	Minor Storm	Major Storm	
Q <sub>o</sub> =	2.1	14.1	cfs
d =	0.30	0.77	feet

Minor storm max. allowable capacity GOOD - greater than the design flow given on sheet 'Inlet Management'  
Major storm max. allowable capacity GOOD - greater than the design flow given on sheet 'Inlet Management'

AREA INLET IN A SWALE

Enter Your Project Name Here

DP-25 INLET

**Inlet Design Information (Input)**

Type of Inlet:  Inlet Type =

Angle of Inclined Grate (must be <= 30 degrees)  $\theta = 0.00$  degrees

Width of Grate  $W = 3.00$  feet

Length of Grate  $L = 3.00$  feet

Open Area Ratio  $A_{RATIO} = 0.70$

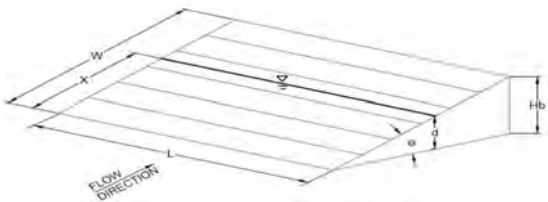
Height of Inclined Grate  $H_B = 0.00$  feet

Clogging Factor  $C_f = 0.50$

Grate Discharge Coefficient  $C_d = 0.84$

Orifice Coefficient  $C_o = 0.56$

Weir Coefficient  $C_w = 1.81$



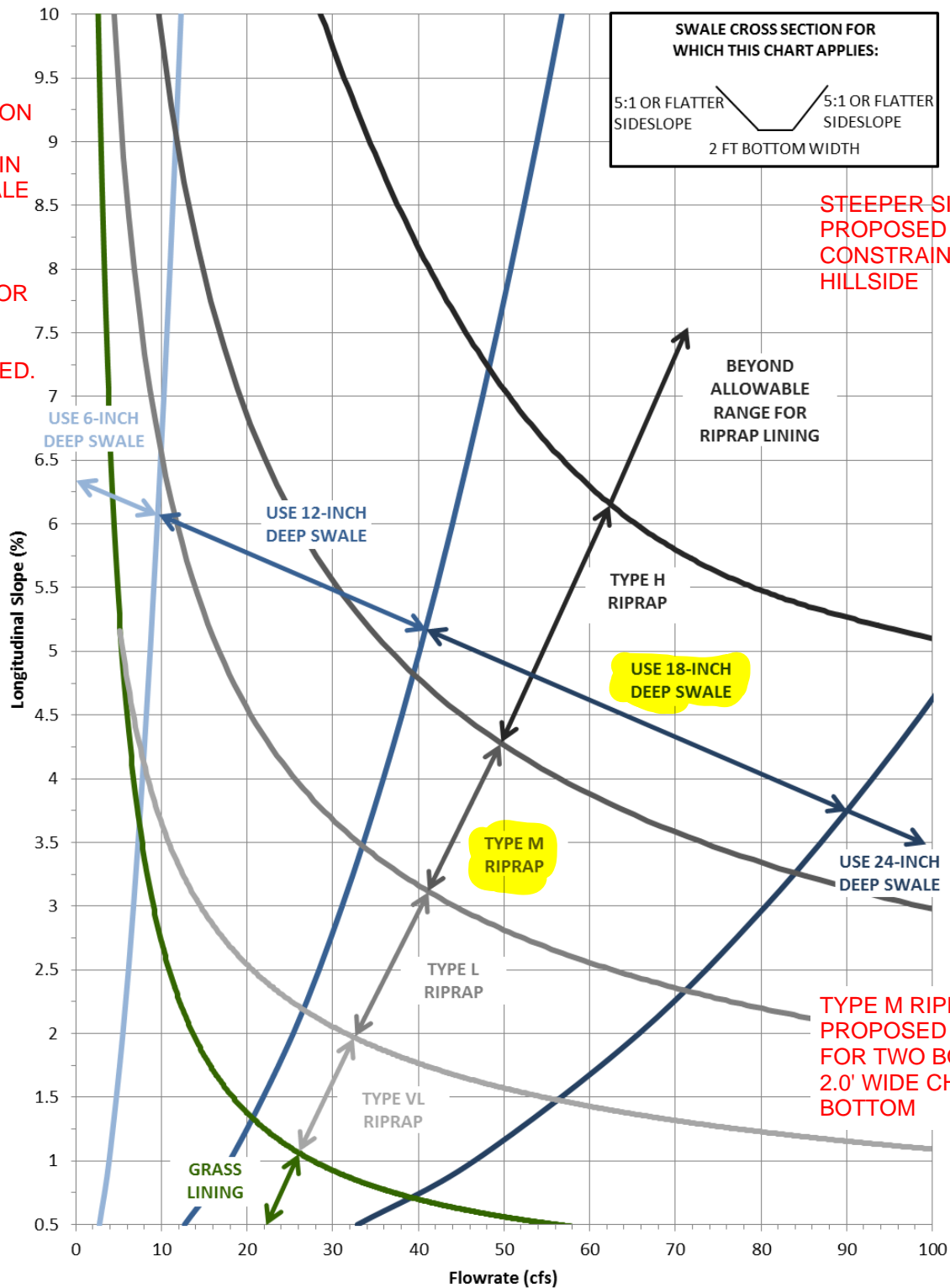
Water Depth at Inlet (for depressed inlets, 1 foot is added for depression)

	MINOR	MAJOR	
$d =$	1.30	1.77	
$Q_a =$	16.2	18.9	cfs
Bypassed Flow, $Q_b =$	0.0	0.0	cfs
Capture Percentage = $Q_a/Q_o =$ C%	100	100	%

**Total Inlet Interception Capacity (assumes clogged condition)**

Warning 04: Froude No. exceeds USDCM Volume I recommendation.

CDOT SPECIFICATION OF PARTIALLY GROUTED RIPRAP IN PORTIONS OF SWALE WHERE SLOPE VS FLOW IS OFF THE CHARTS. SEE GRADING PLANS FOR PORTIONS DESIGNATED AS PARTIALLY GROUTED.



**Figure 8-22. Swale stability chart; 2- to 4-foot bottom width and side slopes between 5:1 and 10:1**  
 (Note: Riprap classifications refer to gradation for riprap used in soil riprap or void-filled riprap. See Figure 8-34 for gradations.) (Source: Muller Engineering Company)

## Worksheet for DP-21 RockSwale

Project Description	
Friction Method	Manning Formula
Solve For	Normal Depth
Input Data	
Roughness Coefficient	0.040
Channel Slope	0.120 ft/ft
Left Side Slope	4.000 H:V
Right Side Slope	3.000 H:V
Bottom Width	2.00 ft
Discharge	51.90 cfs
Results	
Normal Depth	12.2 in
Flow Area	5.7 ft <sup>2</sup>
Wetted Perimeter	9.4 ft
Hydraulic Radius	7.2 in
Top Width	9.12 ft
Critical Depth	17.2 in
Critical Slope	0.026 ft/ft
Velocity	9.17 ft/s
Velocity Head	1.31 ft
Specific Energy	2.32 ft
Froude Number	2.052
Flow Type	Supercritical
GVF Input Data	
Downstream Depth	0.0 in
Length	0.0 ft
Number Of Steps	0
GVF Output Data	
Upstream Depth	0.0 in
Profile Description	N/A
Profile Headloss	0.00 ft
Downstream Velocity	Infinity ft/s
Upstream Velocity	Infinity ft/s
Normal Depth	12.2 in
Critical Depth	17.2 in
Channel Slope	0.120 ft/ft
Critical Slope	0.026 ft/ft



## Worksheet for DP-22 RockSwale

Project Description	
Friction Method	Manning Formula
Solve For	Normal Depth
Input Data	
Roughness Coefficient	0.040
Channel Slope	0.040 ft/ft
Left Side Slope	4.000 H:V
Right Side Slope	3.000 H:V
Bottom Width	2.00 ft
Discharge	60.60 cfs
Results	
Normal Depth	16.7 in
Flow Area	9.6 ft <sup>2</sup>
Wetted Perimeter	12.1 ft
Hydraulic Radius	9.5 in
Top Width	11.74 ft
Critical Depth	18.4 in
Critical Slope	0.025 ft/ft
Velocity	6.34 ft/s
Velocity Head	0.62 ft
Specific Energy	2.02 ft
Froude Number	1.238
Flow Type	Supercritical
GVF Input Data	
Downstream Depth	0.0 in
Length	0.0 ft
Number Of Steps	0
GVF Output Data	
Upstream Depth	0.0 in
Profile Description	N/A
Profile Headloss	0.00 ft
Downstream Velocity	Infinity ft/s
Upstream Velocity	Infinity ft/s
Normal Depth	16.7 in
Critical Depth	18.4 in
Channel Slope	0.040 ft/ft
Critical Slope	0.025 ft/ft

## Worksheet for POND OUTFALL-SEC26A

Project Description	
Friction Method	Manning Formula
Solve For	Normal Depth
Input Data	
Roughness Coefficient	0.013
Channel Slope	0.005 ft/ft
Bottom Width	18.00 ft
Discharge	42.90 cfs
Results	
Normal Depth	5.9 in
Flow Area	8.8 ft <sup>2</sup>
Wetted Perimeter	19.0 ft
Hydraulic Radius	5.6 in
Top Width	18.00 ft
Critical Depth	6.7 in
Critical Slope	0.003 ft/ft
Velocity	4.86 ft/s
Velocity Head	0.37 ft
Specific Energy	0.86 ft
Froude Number	1.222
Flow Type	Supercritical
GVF Input Data	
Downstream Depth	0.0 in
Length	0.0 ft
Number Of Steps	0
GVF Output Data	
Upstream Depth	0.0 in
Profile Description	N/A
Profile Headloss	0.00 ft
Downstream Velocity	Infinity ft/s
Upstream Velocity	Infinity ft/s
Normal Depth	5.9 in
Critical Depth	6.7 in
Channel Slope	0.005 ft/ft
Critical Slope	0.003 ft/ft

## Worksheet for EX. CH-SEC26B

Project Description	
Friction Method	Manning Formula
Solve For	Normal Depth
Input Data	
Channel Slope	0.075 ft/ft
Discharge	42.90 cfs

### Section Definitions

	Station (ft)	Elevation (ft)
	1+00	7,102.74
	1+40	7,102.79
	1+80	7,102.48
	2+20	7,102.31
	2+60	7,101.48
	3+00	7,101.41

### Roughness Segment Definitions

Start Station	Ending Station	Roughness Coefficient
(1+00, 7,102.74)	(3+00, 7,101.41)	0.035

#### Options

Current Roughness Weighted Method	Pavlovskii's Method
Open Channel Weighting Method	Pavlovskii's Method
Closed Channel Weighting Method	Pavlovskii's Method

#### Results

Normal Depth	3.3 in
Elevation Range	7,101.4 to 7,102.8 ft
Flow Area	10.5 ft <sup>2</sup>
Wetted Perimeter	50.0 ft
Hydraulic Radius	2.5 in
Top Width	49.74 ft
Normal Depth	3.3 in
Critical Depth	4.2 in
Critical Slope	0.028 ft/ft
Velocity	4.10 ft/s
Velocity Head	0.26 ft
Specific Energy	0.53 ft
Froude Number	1.576
Flow Type	Supercritical

## Worksheet for EX. CH-SEC26B

---

### GVF Input Data

---

Downstream Depth	0.0 in
Length	0.0 ft
Number Of Steps	0

---

### GVF Output Data

---

Upstream Depth	0.0 in
Profile Description	N/A
Profile Headloss	0.00 ft
Downstream Velocity	Infinity ft/s
Upstream Velocity	Infinity ft/s
Normal Depth	3.3 in
Critical Depth	4.2 in
Channel Slope	0.075 ft/ft
Critical Slope	0.028 ft/ft

---

## Worksheet for **BYPASS OUTFALL-SEC35A**

Project Description	
Friction Method	Manning
	Formula
Solve For	Normal Depth
Input Data	
Roughness Coefficient	0.013
Channel Slope	0.005 ft/ft
Bottom Width	70.00 ft
Discharge	172.40 cfs
Results	
Normal Depth	5.9 in
Flow Area	34.5 ft <sup>2</sup>
Wetted Perimeter	71.0 ft
Hydraulic Radius	5.8 in
Top Width	70.00 ft
Critical Depth	6.9 in
Critical Slope	0.003 ft/ft
Velocity	5.00 ft/s
Velocity Head	0.39 ft
Specific Energy	0.88 ft
Froude Number	1.255
Flow Type	Supercritical
GVF Input Data	
Downstream Depth	0.0 in
Length	0.0 ft
Number Of Steps	0
GVF Output Data	
Upstream Depth	0.0 in
Profile Description	N/A
Profile Headloss	0.00 ft
Downstream Velocity	Infinity ft/s
Upstream Velocity	Infinity ft/s
Normal Depth	5.9 in
Critical Depth	6.9 in
Channel Slope	0.005 ft/ft
Critical Slope	0.003 ft/ft

## Worksheet for EX. CH-SEC35B

Project Description	
Friction Method	Manning Formula
Solve For	Normal Depth
Input Data	
Channel Slope	0.050 ft/ft
Discharge	172.40 cfs

### Section Definitions

	Station (ft)	Elevation (ft)
	1+00	7,116.59
	1+18	7,116.29
	1+41	7,115.33
	1+59	7,114.37
	1+79	7,114.21
	1+96	7,114.19
	2+18	7,114.29
	2+37	7,114.47
	2+72	7,115.13
	2+96	7,116.00
	3+14	7,118.00

### Roughness Segment Definitions

Start Station	Ending Station	Roughness Coefficient
(1+00, 7,116.59)	(3+14, 7,118.00)	0.035

#### Options

Current Roughness Weighted Method	Pavlovskii's Method
Open Channel Weighting Method	Pavlovskii's Method
Closed Channel Weighting Method	Pavlovskii's Method

#### Results

Normal Depth	6.2 in
Elevation Range	7,114.2 to 7,118.0 ft
Flow Area	35.4 ft <sup>2</sup>
Wetted Perimeter	96.5 ft
Hydraulic Radius	4.4 in
Top Width	96.45 ft
Normal Depth	6.2 in
Critical Depth	7.4 in
Critical Slope	0.023 ft/ft
Velocity	4.87 ft/s

## Worksheet for EX. CH-SEC35B

---

### Results

---

Velocity Head	0.37 ft
Specific Energy	0.88 ft
Froude Number	1.416
Flow Type	Supercritical

---

### GVF Input Data

---

Downstream Depth	0.0 in
Length	0.0 ft
Number Of Steps	0

---

### GVF Output Data

---

Upstream Depth	0.0 in
Profile Description	N/A
Profile Headloss	0.00 ft
Downstream Velocity	Infinity ft/s
Upstream Velocity	Infinity ft/s
Normal Depth	6.2 in
Critical Depth	7.4 in
Channel Slope	0.050 ft/ft
Critical Slope	0.023 ft/ft

---

**DETENTION & STORMWATER  
QUALITY POND 'A'**



## Site-Level Low Impact Development (LID) Design Effective Impervious Calculator

### LID Credit by Impervious Reduction Factor (IRF) Method

User Input			
Calculated cells			
***Design Storm: 1-Hour Rain Depth	WQCV Event	0.53	inches
***Minor Storm: 1-Hour Rain Depth	10-Year Event	1.75	inches
***Major Storm: 1-Hour Rain Depth	100-Year Event	2.52	inches
Optional User Defined Storm	CUHP		
(CUHP) NOAA 1 Hour Rainfall Depth and Frequency for User Defined Storm	100-Year Event		
Max Intensity for Optional User Defined Storm		0	

**Designer:** Matt Larson  
**Company:** Classic Consulting Engineers & Surveyors, LLC  
**Date:** November 16, 2021  
**Project:** FOREST LAKES - FILING 7  
**Location:** POND A

#### SITE INFORMATION (USER-INPUT)

Sub-basin Identifier	PIPE 25	BASIN R	BASIN U															
Receiving Pervious Area Soil Type	Sandy Loam	Sandy Loam	Sandy Loam															
Total Area (ac., Sum of DCIA, UIA, RPA, & SPA)	35.370	1.640	1.280															
Directly Connected Impervious Area (DCIA, acres)	6.487	0.012	0.000															
Unconnected Impervious Area (UIA, acres)	9.149	0.902	0.000															
Receiving Pervious Area (RPA, acres)	7.396	0.726	0.620															
Separate Pervious Area (SPA, acres)	12.338	0.000	0.660															
RPA Treatment Type: Conveyance (C), Volume (V), or Permeable Pavement (PP)	C	C	C															

#### CALCULATED RESULTS (OUTPUT)

Total Calculated Area (ac, check against input)	35.370	1.640	1.280															
Directly Connected Impervious Area (DCIA, %)	18.3%	0.7%	0.0%															
Unconnected Impervious Area (UIA, %)	25.9%	55.0%	0.0%															
Receiving Pervious Area (RPA, %)	20.9%	44.3%	48.4%															
Separate Pervious Area (SPA, %)	34.9%	0.0%	51.6%															
A <sub>R</sub> (RPA / UIA)	0.808	0.805	0.000															
I <sub>a</sub> Check	0.550	0.550	1.000															
f / I for WQCV Event:	2.0	2.0	2.0															
f / I for 10-Year Event:	0.5	0.5	0.5															
f / I for 100-Year Event:	0.3	0.3	0.3															
<b>f / I for Optional User Defined Storm CUHP:</b>																		
IRF for WQCV Event:	0.64	0.64	1.00															
IRF for 10-Year Event:	0.90	0.90	1.00															
IRF for 100-Year Event:	0.94	0.94	1.00															
<b>IRF for Optional User Defined Storm CUHP:</b>																		
Total Site Imperviousness: I <sub>total</sub>	44.2%	55.7%	0.0%															
Effective Imperviousness for WQCV Event:	34.9%	36.0%	0.0%															
Effective Imperviousness for 10-Year Event:	41.7%	50.4%	0.0%															
Effective Imperviousness for 100-Year Event:	42.6%	52.4%	0.0%															
<b>Effective Imperviousness for Optional User Defined Storm CUHP:</b>																		

#### LID / EFFECTIVE IMPERVIOUSNESS CREDITS

WQCV Event CREDIT: Reduce Detention By:	13.0%	24.1%	N/A	N/A	N/A	N/A	N/A	N/A	N/A	N/A	N/A	N/A	N/A	N/A	N/A	N/A	N/A	N/A	
10-Year Event CREDIT**: Reduce Detention By:	5.9%	9.9%	N/A	N/A	N/A	N/A	N/A	N/A	N/A	N/A	N/A	N/A	N/A	N/A	N/A	N/A	N/A	N/A	
100-Year Event CREDIT**: Reduce Detention By:	3.6%	5.9%	N/A	N/A	N/A	N/A	N/A	N/A	N/A	N/A	N/A	N/A	N/A	N/A	N/A	N/A	N/A	N/A	
<b>User Defined CUHP CREDIT: Reduce Detention By:</b>																			

<b>Total Site Imperviousness:</b>	<b>43.2%</b>
<b>Total Site Effective Imperviousness for WQCV Event:</b>	<b>33.8%</b>
<b>Total Site Effective Imperviousness for 10-Year Event:</b>	<b>40.7%</b>
<b>Total Site Effective Imperviousness for 100-Year Event:</b>	<b>41.6%</b>
<b>Total Site Effective Imperviousness for Optional User Defined Storm CUHP:</b>	

#### Notes:

- \* Use Green-Ampt average infiltration rate values from Table 3-3.
- \*\* Flood control detention volume credits based on empirical equations from Storage Chapter of USDCM.
- \*\*\* Method assumes that 1-hour rainfall depth is equivalent to 1-hour intensity for calculation purposed

**Design Procedure Form: Extended Detention Basin (EDB)**

**Designer:**     Matt Larson      
**Company:**     Classic Consulting Engineers & Surveyors, LLC      
**Date:**     November 16, 2021      
**Project:**     FOREST LAKES - FILING 7      
**Location:**     POND A - FINAL DESIGN    

<p>1. Basin Storage Volume</p> <p>A) Effective Imperviousness of Tributary Area, <math>I_a</math></p> <p>B) Tributary Area's Imperviousness Ratio (<math>i = I_a / 100</math>)</p> <p>C) Contributing Watershed Area</p> <p>D) For Watersheds Outside of the Denver Region, Depth of Average Runoff Producing Storm</p> <p>E) Design Concept (Select EURV when also designing for flood control)</p> <p>F) Design Volume (WQCV) Based on 40-hour Drain Time (<math>V_{DESIGN} = (1.0 * (0.91 * i^3 - 1.19 * i^2 + 0.78 * i)) / 12 * Area</math>)</p> <p>G) For Watersheds Outside of the Denver Region, Water Quality Capture Volume (WQCV) Design Volume (<math>V_{WQCV\ OTHER} = (d_6 * (V_{DESIGN} / 0.43))</math>)</p> <p>H) User Input of Water Quality Capture Volume (WQCV) Design Volume (Only if a different WQCV Design Volume is desired)</p> <p>I) Predominant Watershed NRCS Soil Group</p> <p>J) Excess Urban Runoff Volume (EURV) Design Volume                  For HSG A: <math>EURV_A = 1.68 * i^{1.28}</math>                  For HSG B: <math>EURV_B = 1.36 * i^{1.08}</math>                  For HSG C/D: <math>EURV_{C/D} = 1.20 * i^{1.08}</math> </p>	<p><math>I_a =</math> <u>    43.2    </u> %</p> <p><math>i =</math> <u>    0.432    </u></p> <p>Area = <u>    38.290    </u> ac</p> <p><math>d_6 =</math> <u>    0.42    </u> in</p> <div style="border: 1px solid black; padding: 5px; margin-bottom: 10px;">                 Choose One _____  <input type="radio"/> Water Quality Capture Volume (WQCV)  <input checked="" type="radio"/> Excess Urban Runoff Volume (EURV)             </div> <p><math>V_{DESIGN} =</math> <u>    0.601    </u> ac-ft</p> <p><math>V_{DESIGN\ OTHER} =</math> <u>    0.587    </u> ac-ft</p> <p><math>V_{DESIGN\ USER} =</math> _____ ac-ft</p> <div style="border: 1px solid black; padding: 5px; margin-bottom: 10px;">                 Choose One _____  <input type="radio"/> A  <input checked="" type="radio"/> B  <input type="radio"/> C / D             </div> <p>EURV = <u>    1.753    </u> ac-ft</p>
<p>2. Basin Shape: Length to Width Ratio (A basin length to width ratio of at least 2:1 will improve TSS reduction.)</p>	<p>L : W = <u>    2.0    </u> : 1</p>
<p>3. Basin Side Slopes</p> <p>A) Basin Maximum Side Slopes (Horizontal distance per unit vertical, 4:1 or flatter preferred)</p>	<p>Z = <u>    4.00    </u> ft / ft</p>
<p>4. Inlet</p> <p>A) Describe means of providing energy dissipation at concentrated inflow locations:</p>	<p align="center">_____</p> <p align="center">Impact Structures</p> <p>_____</p> <p>_____</p> <p>_____</p>

**Design Procedure Form: Extended Detention Basin (EDB)**

**Designer:** Matt Larson  
**Company:** Classic Consulting Engineers & Surveyors, LLC  
**Date:** November 16, 2021  
**Project:** FOREST LAKES - FILING 7  
**Location:** POND A - FINAL DESIGN

<p>5. Forebay</p> <p>A) Minimum Forebay Volume (<math>V_{FMIN} =</math> <u>3%</u> of the WQCV)</p> <p>B) Actual Forebay Volume</p> <p>C) Forebay Depth (<math>D_F =</math> <u>18</u> inch maximum)</p> <p>D) Forebay Discharge</p> <p style="margin-left: 40px;">i) Undetained 100-year Peak Discharge</p> <p style="margin-left: 40px;">ii) Forebay Discharge Design Flow (<math>Q_F = 0.02 * Q_{100}</math>)</p> <p>E) Forebay Discharge Design</p> <p>F) Discharge Pipe Size (minimum 8-inches)</p> <p>G) Rectangular Notch Width</p>	<p><math>V_{FMIN} =</math> <u>0.018</u> ac-ft</p> <p><math>V_F =</math> <u>0.022</u> ac-ft</p> <p><math>D_F =</math> <u>18.0</u> in</p> <p><math>Q_{100} =</math> <u>126.10</u> cfs</p> <p><math>Q_F =</math> <u>2.52</u> cfs</p> <div style="border: 1px solid black; padding: 5px; margin: 5px 0;"> <p>Choose One</p> <p><input type="radio"/> Berm With Pipe</p> <p><input checked="" type="radio"/> Wall with Rect. Notch</p> <p><input type="radio"/> Wall with V-Notch Weir</p> </div> <p style="color: blue; margin-left: 100px;">(flow too small for berm w/ pipe)</p> <p>Calculated <math>D_p =</math> <u>          </u> in</p> <p>Calculated <math>W_N =</math> <u>8.5</u> in</p>
<p>6. Trickle Channel</p> <p>A) Type of Trickle Channel</p> <p>F) Slope of Trickle Channel</p>	<div style="border: 1px solid black; padding: 5px; margin: 5px 0;"> <p>Choose One</p> <p><input checked="" type="radio"/> Concrete</p> <p><input type="radio"/> Soft Bottom</p> </div> <p><math>S =</math> <u>0.0080</u> ft / ft</p>
<p>7. Micropool and Outlet Structure</p> <p>A) Depth of Micropool (2.5-feet minimum)</p> <p>B) Surface Area of Micropool (10 ft<sup>2</sup> minimum)</p> <p>C) Outlet Type</p> <p>D) Smallest Dimension of Orifice Opening Based on Hydrograph Routing (Use UD-Detention)</p> <p>E) Total Outlet Area</p>	<p><math>D_M =</math> <u>2.5</u> ft</p> <p><math>A_M =</math> <u>274</u> sq ft</p> <div style="border: 1px solid black; padding: 5px; margin: 5px 0;"> <p>Choose One</p> <p><input checked="" type="radio"/> Orifice Plate</p> <p><input type="radio"/> Other (Describe):</p> </div> <hr style="border: 0.5px solid black; margin: 5px 0;"/> <hr style="border: 0.5px solid black; margin: 5px 0;"/> <hr style="border: 0.5px solid black; margin: 5px 0;"/> <p><math>D_{orifice} =</math> <u>2.50</u> inches</p> <p><math>A_{ot} =</math> <u>14.00</u> square inches</p>

**Design Procedure Form: Extended Detention Basin (EDB)**

**Designer:**     Matt Larson      
**Company:**     Classic Consulting Engineers & Surveyors, LLC      
**Date:**     November 16, 2021      
**Project:**     FOREST LAKES - FILING 7      
**Location:**     POND A - FINAL DESIGN    

<p>8. Initial Surcharge Volume</p> <p>A) Depth of Initial Surcharge Volume (Minimum recommended depth is 4 inches)</p> <p>B) Minimum Initial Surcharge Volume (Minimum volume of 0.3% of the WQCV)</p> <p>C) Initial Surcharge Provided Above Micropool</p>	<p><math>D_{IS} = </math> <u>    4    </u> in</p> <p><math>V_{IS} = </math> <u>    76.7    </u> cu ft</p> <p><math>V_s = </math> <u>    91.3    </u> cu ft</p>
<p>9. Trash Rack</p> <p>A) Water Quality Screen Open Area: <math>A_t = A_{ot} * 38.5 * (e^{-0.095D})</math></p> <p>B) Type of Screen (If specifying an alternative to the materials recommended in the USDCM, indicate "other" and enter the ratio of the total open are to the total screen are for the material specified.)</p> <p style="padding-left: 40px;">Other (Y/N): <u>    N    </u></p> <p>C) Ratio of Total Open Area to Total Area (only for type 'Other')</p> <p>D) Total Water Quality Screen Area (based on screen type)</p> <p>E) Depth of Design Volume (EURV or WQCV) (Based on design concept chosen under 1E)</p> <p>F) Height of Water Quality Screen (<math>H_{TR}</math>)</p> <p>G) Width of Water Quality Screen Opening (<math>W_{opening}</math>) (Minimum of 12 inches is recommended)</p>	<p><math>A_t = </math> <u>    425    </u> square inches</p> <p><u>    Aluminum Amico-Klemp SR Series with Cross Rods 2" O.C.    </u></p> <hr/> <hr/> <p>User Ratio =</p> <p><math>A_{total} = </math> <u>    599    </u> sq. in.</p> <p><math>H = </math> <u>    6.4    </u> feet</p> <p><math>H_{TR} = </math> <u>    104.8    </u> inches</p> <p><math>W_{opening} = </math> <u>    12.0    </u> inches</p>



JOB NAME: FOREST LAKES FILING 7  
 JOB NUMBER: 1175.70  
 DATE: 09/22/21  
 CALCULATED BY: MAL

**POND A - TOP OF BERM**

POND SIZING WITH PONDPACK EQUATION:  
 INSERT POND DESIGN SIZE INFO: (RED)

POND ELEVATION :	
(from lowest to highest)	
	7108.00
	7108.00
	7108.25
	7110.00
	7112.00
	7114.00
	7116.00
	7117.00
	7118.00
	7120.00

AREA (BTM to TOP):		
	-	acres
	274	0.01 acres
	274	0.01 acres
	8,633	0.20 acres
	16,740	0.38 acres
	21,450	0.49 acres
	26,602	0.61 acres
	29,391	0.67 acres
	32,227	0.74 acres
	38,927	0.89 acres
	-	acres
	-	acres

**PRELIMINARY SIZE:**

VOLUME =  $1/3\{(EL2-EL1)*(A1+A2+((A1*A2)^.5))\}$

**CUMMULATIVE VOLUME:**

-	AC-FT	from	7,108	to	7,108	
0.00	AC-FT	from	7,108	to	7,108	0.00
0.14	AC-FT	from	7,108	to	7,110	0.14
0.57	AC-FT	from	7,110	to	7,112	0.71
0.87	AC-FT	from	7,112	to	7,114	1.57
1.09	AC-FT	from	7,114	to	7,116	2.66
0.64	AC-FT	from	7,116	to	7,117	3.30
0.70	AC-FT	from	7,117	to	7,118	4.00
1.61	AC-FT	from	7,118	to	7,120	5.61
-	AC-FT	from	7,120	to	-	5.61
-	AC-FT	from	-	to	-	5.61

\*SIZING IS FOR PRELIMINARY PURPOSES ONLY.

**VOLUME = 5.61 AC-FT**

**APPROXIMATE SURFACE AREA REQUIREMENT**

POND DEPTH (FT)	POND VOLUME			SURFACE AREA (SF)
	AC-FT	=	CF	
4	5.61	=	#####	61,126
6	5.61	=	#####	40,751
8	5.61	=	#####	30,563
10	5.61	=	#####	24,451

JOB NAME: FOREST LAKES FILING 7  
 JOB NUMBER: 1175.70  
 DATE: 09/22/21  
 CALCULATED BY: MAL

**POND A - SPILLWAY**

POND SIZING WITH PONDPACK EQUATION:  
 INSERT POND DESIGN SIZE INFO: (RED)

POND ELEVATION :	
(from lowest to highest)	
	7108.00
	7108.00
	7108.25
	7110.00
	7112.00
	7114.00
	7116.00
	7117.00

AREA (BTM to TOP):		
	-	acres
	274	0.01 acres
	274	0.01 acres
	8,633	0.20 acres
	16,740	0.38 acres
	21,450	0.49 acres
	26,602	0.61 acres
	29,391	0.67 acres
	-	acres
	-	acres
	-	acres
	-	acres

**PRELIMINARY SIZE:**

VOLUME =  $1/3\{(EL2-EL1)*(A1+A2+((A1*A2)^.5))\}$

**CUMMULATIVE VOLUME:**

-	AC-FT	from	7,108	to	7,108	
0.00	AC-FT	from	7,108	to	7,108	0.00
0.14	AC-FT	from	7,108	to	7,110	0.14
0.57	AC-FT	from	7,110	to	7,112	0.71
0.87	AC-FT	from	7,112	to	7,114	1.57
1.09	AC-FT	from	7,114	to	7,116	2.66
0.64	AC-FT	from	7,116	to	7,117	3.30
-	AC-FT	from	7,117	to	-	3.30
-	AC-FT	from	-	to	-	3.30
-	AC-FT	from	-	to	-	3.30
-	AC-FT	from	-	to	-	3.30

\*SIZING IS FOR PRELIMINARY PURPOSES ONLY.

**VOLUME = 3.30 AC-FT**

**APPROXIMATE SURFACE AREA REQUIREMENT**

POND DEPTH (FT)	POND VOLUME			SURFACE AREA (SF)
	AC-FT	=	CF	
4	3.30	=	#####	35,919
6	3.30	=	#####	23,946
8	3.30	=	#####	17,960
10	3.30	=	#####	14,368

JOB NAME: FOREST LAKES FILING 7  
 JOB NUMBER: 1175.70  
 DATE: 09/22/21  
 CALCULATED BY: MAL

**POND A - TOP OF BOX/EURV**

POND SIZING WITH PONDPACK EQUATION:  
 INSERT POND DESIGN SIZE INFO: (RED)

POND ELEVATION :	
(from lowest to highest)	
	7108.00
	7108.00
	7108.25
	7110.00
	7112.00
	7114.00
	7114.40

AREA (BTM to TOP):		
	-	acres
	274	0.01 acres
	274	0.01 acres
	8,633	0.20 acres
	16,740	0.38 acres
	21,450	0.49 acres
	22,688	0.52 acres
	-	acres
	-	acres
	-	acres
	-	acres
	-	acres
	-	acres

**PRELIMINARY SIZE:**

VOLUME =  $1/3\{(EL2-EL1)*(A1+A2+((A1*A2)^.5))\}$

**CUMMULATIVE VOLUME:**

-	AC-FT	from	7,108	to	7,108	
0.00	AC-FT	from	7,108	to	7,108	0.00
0.14	AC-FT	from	7,108	to	7,110	0.14
0.57	AC-FT	from	7,110	to	7,112	0.71
0.87	AC-FT	from	7,112	to	7,114	1.57
0.20	AC-FT	from	7,114	to	7,114	1.77
-	AC-FT	from	7,114	to	-	1.77
-	AC-FT	from	-	to	-	1.77
-	AC-FT	from	-	to	-	1.77
-	AC-FT	from	-	to	-	1.77
-	AC-FT	from	-	to	-	1.77

\*SIZING IS FOR PRELIMINARY PURPOSES ONLY.

**VOLUME = 1.77 AC-FT**

**APPROXIMATE SURFACE AREA REQUIREMENT**

POND DEPTH (FT)	POND VOLUME			SURFACE AREA (SF)
	AC-FT	=	CF	
4	1.77	=	77,230	19,308
6	1.77	=	77,230	12,872
8	1.77	=	77,230	9,654
10	1.77	=	77,230	7,723

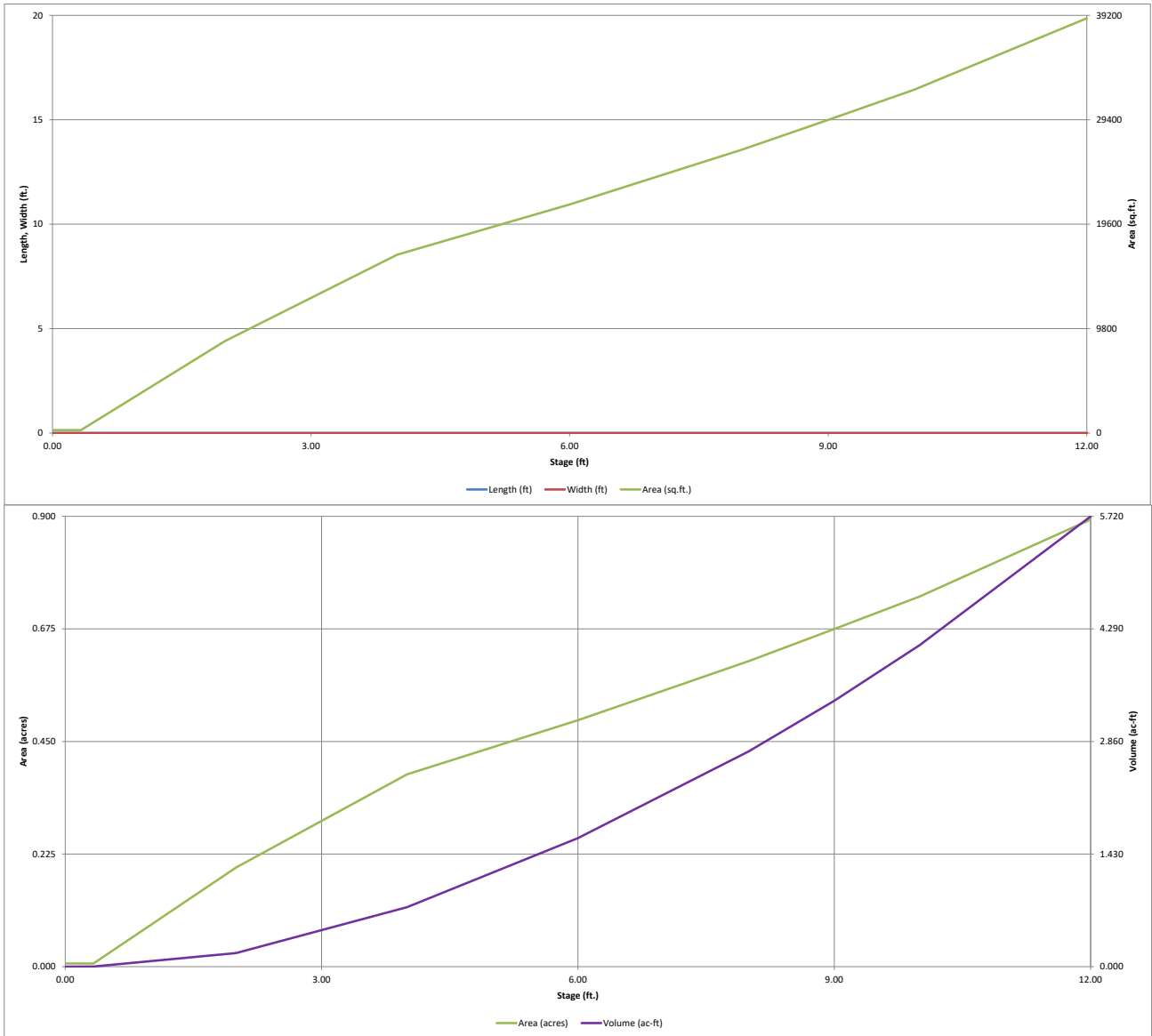






# DETENTION BASIN STAGE-STORAGE TABLE BUILDER

*MHFD-Detention, Version 4.04 (February 2021)*

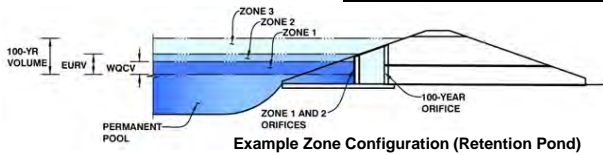


# DETENTION BASIN OUTLET STRUCTURE DESIGN

*MHFD-Detention, Version 4.04 (February 2021)*

Project: **FOREST LAKES FILING 7**

Basin ID: **POND A**



	Estimated Stage (ft)	Estimated Volume (ac-ft)	Outlet Type
Zone 1 (WQCV)	3.58	0.601	Orifice Plate
Zone 2 (EURV)	6.24	1.147	Orifice Plate
Zone 3 (100-year)	8.78	1.481	Weir&Pipe (Circular)
<b>Total (all zones)</b>		<b>3.229</b>	

User Input: Orifice at Underdrain Outlet (typically used to drain WQCV in a Filtration BMP)

Underdrain Orifice Invert Depth =	N/A	ft (distance below the filtration media surface)
Underdrain Orifice Diameter =	N/A	inches

Calculated Parameters for Underdrain	
Underdrain Orifice Area =	N/A ft <sup>2</sup>
Underdrain Orifice Centroid =	N/A feet

User Input: Orifice Plate with one or more orifices or Elliptical Slot Weir (typically used to drain WQCV and/or EURV in a sedimentation BMP)

Invert of Lowest Orifice =	0.00	ft (relative to basin bottom at Stage = 0 ft)
Depth at top of Zone using Orifice Plate =	6.40	ft (relative to basin bottom at Stage = 0 ft)
Orifice Plate: Orifice Vertical Spacing =	24.90	inches
Orifice Plate: Orifice Area per Row =	N/A	inches

Calculated Parameters for Plate	
WQ Orifice Area per Row =	N/A ft <sup>2</sup>
Elliptical Half-Width =	N/A feet
Elliptical Slot Centroid =	N/A feet
Elliptical Slot Area =	N/A ft <sup>2</sup>

User Input: Stage and Total Area of Each Orifice Row (numbered from lowest to highest)

	Row 1 (required)	Row 2 (optional)	Row 3 (optional)	Row 4 (optional)	Row 5 (optional)	Row 6 (optional)	Row 7 (optional)	Row 8 (optional)
Stage of Orifice Centroid (ft)	0.00	2.13	4.27					
Orifice Area (sq. inches)	2.00	6.00	6.00					

	Row 9 (optional)	Row 10 (optional)	Row 11 (optional)	Row 12 (optional)	Row 13 (optional)	Row 14 (optional)	Row 15 (optional)	Row 16 (optional)
Stage of Orifice Centroid (ft)								
Orifice Area (sq. inches)								

User Input: Vertical Orifice (Circular or Rectangular)

	Not Selected	Not Selected	
Invert of Vertical Orifice =	N/A	N/A	ft (relative to basin bottom at Stage = 0 ft)
Depth at top of Zone using Vertical Orifice =	N/A	N/A	ft (relative to basin bottom at Stage = 0 ft)
Vertical Orifice Diameter =	N/A	N/A	inches

Calculated Parameters for Vertical Orifice	
Vertical Orifice Area =	N/A ft <sup>2</sup>
Vertical Orifice Centroid =	N/A feet

User Input: Overflow Weir (Dropbox with Flat or Sloped Gate and Outlet Pipe OR Rectangular/Trapezoidal Weir (and No Outlet Pipe))

	Zone 3 Weir	Not Selected	
Overflow Weir Front Edge Height, H <sub>o</sub> =	6.40	N/A	ft (relative to basin bottom at Stage = 0 ft)
Overflow Weir Front Edge Length =	8.00	N/A	feet
Overflow Weir Gate Slope =	4.00	N/A	H:V
Horiz. Length of Weir Sides =	4.00	N/A	feet
Overflow Gate Type =	Type C Gate	N/A	
Debris Clogging % =	50%	N/A	%

Calculated Parameters for Overflow Weir	
Height of Gate Upper Edge, H <sub>u</sub> =	7.40 feet
Overflow Weir Slope Length =	4.12 feet
Gate Open Area / 100-yr Orifice Area =	3.25
Overflow Gate Open Area w/o Debris =	22.96 ft <sup>2</sup>
Overflow Gate Open Area w/ Debris =	11.48 ft <sup>2</sup>

User Input: Outlet Pipe w/ Flow Restriction Plate (Circular Orifice, Restrictor Plate, or Rectangular Orifice)

	Zone 3 Circular	Not Selected	
Depth to Invert of Outlet Pipe =	0.20	N/A	ft (distance below basin bottom at Stage = 0 ft)
Circular Orifice Diameter =	36.00	N/A	inches

Calculated Parameters for Outlet Pipe w/ Flow Restriction Plate	
Outlet Orifice Area =	7.07 ft <sup>2</sup>
Outlet Orifice Centroid =	1.50 feet
Half-Central Angle of Restrictor Plate on Pipe =	N/A radians

User Input: Emergency Spillway (Rectangular or Trapezoidal)

Spillway Invert Stage =	9.00	ft (relative to basin bottom at Stage = 0 ft)
Spillway Crest Length =	30.00	feet
Spillway End Slopes =	4.00	H:V
Freeboard above Max Water Surface =	1.00	feet

Calculated Parameters for Spillway	
Spillway Design Flow Depth =	0.98 feet
Stage at Top of Freeboard =	10.98 feet
Basin Area at Top of Freeboard =	0.82 acres
Basin Volume at Top of Freeboard =	4.85 acre-ft

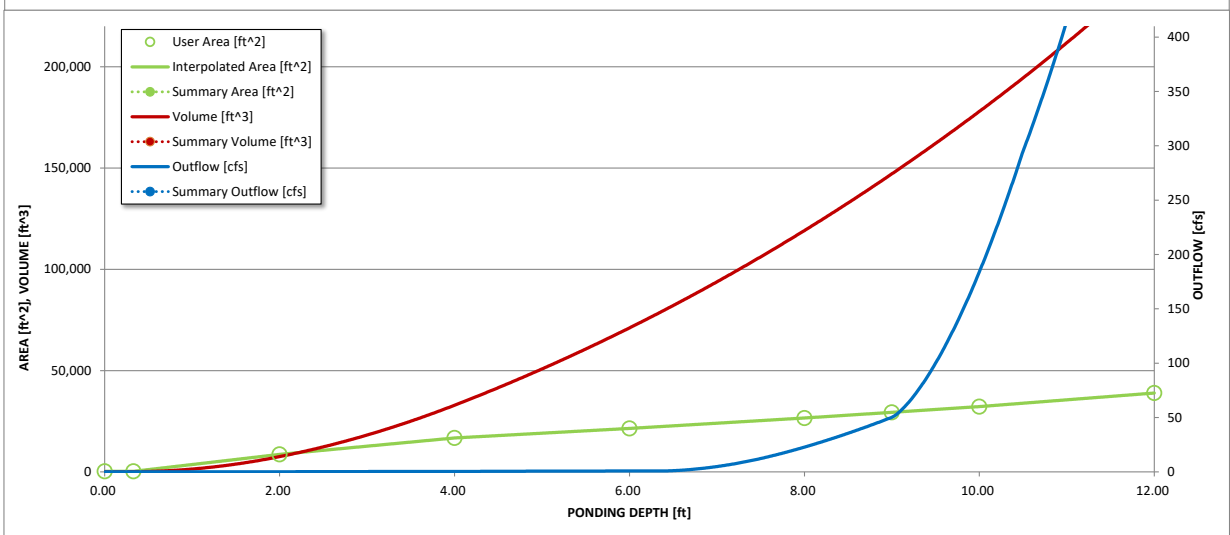
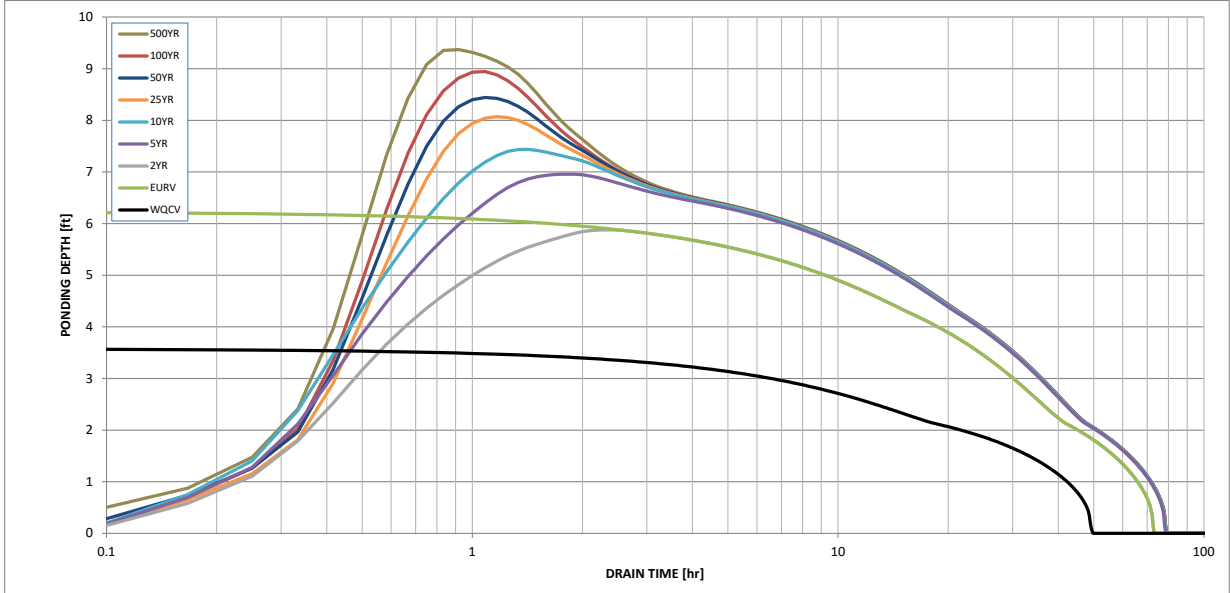
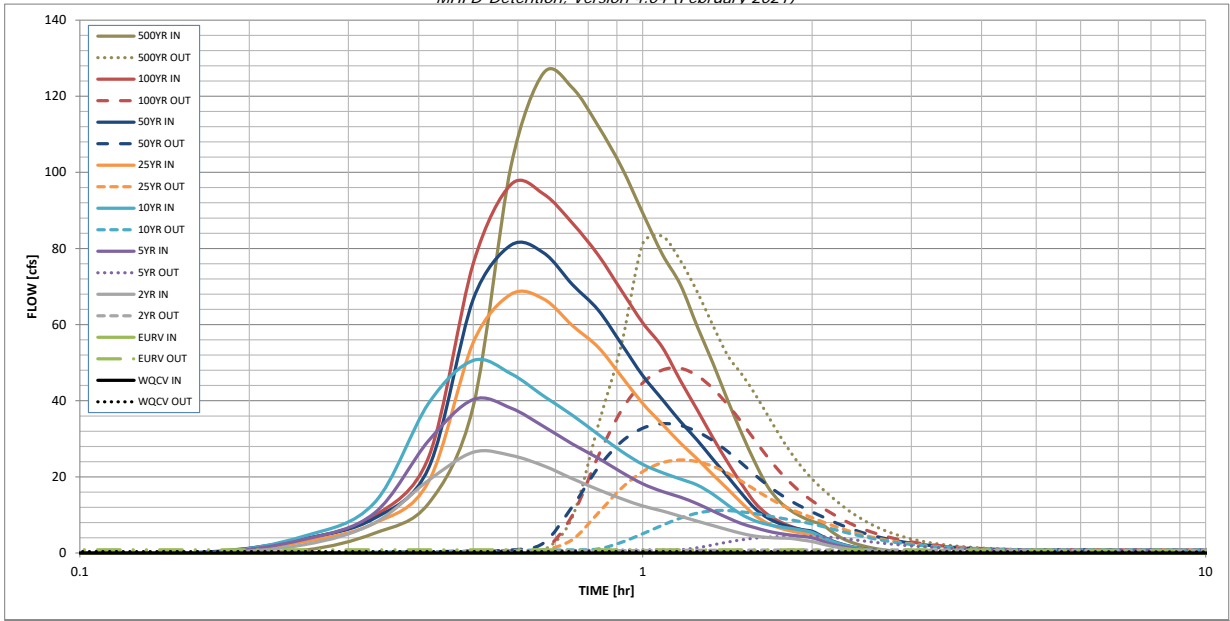
## Routed Hydrograph Results

*The user can override the default CUHP hydrographs and runoff volumes by entering new values in the Inflow Hydrographs table (Columns W through AF).*

	WQCV	EURV	2 Year	5 Year	10 Year	25 Year	50 Year	100 Year	500 Year
Design Storm Return Period	N/A	N/A	1.19	1.50	1.75	2.00	2.25	2.52	3.10
One-Hour Rainfall Depth (in)	N/A	N/A	1.696	2.495	3.208	4.210	5.000	6.021	7.930
CUHP Runoff Volume (acre-ft)	0.601	1.748	1.696	2.495	3.208	4.210	5.000	6.021	7.930
Inflow Hydrograph Volume (acre-ft)	N/A	N/A	1.696	2.495	3.208	4.210	5.000	6.021	7.930
CUHP Predevelopment Peak Q (cfs)	N/A	N/A	4.4	12.3	18.6	32.9	41.3	52.8	72.2
OPTIONAL Override Predevelopment Peak Q (cfs)	N/A	N/A							
Predevelopment Unit Peak Flow, q (cfs/acre)	N/A	N/A	0.12	0.32	0.49	0.86	1.08	1.38	1.88
Peak Inflow Q (cfs)	N/A	N/A	26.5	40.3	50.6	68.0	80.9	96.8	126.1
Peak Outflow Q (cfs)	0.4	0.9	0.8	4.4	11.2	24.4	34.0	48.5	83.2
Ratio Peak Outflow to Predevelopment Q	N/A	N/A	N/A	0.4	0.6	0.7	0.8	0.9	1.2
Structure Controlling Flow	Plate	Plate	Plate	Overflow Weir 1	Overflow Weir 1	Overflow Weir 1	Overflow Weir 1	Overflow Weir 1	Spillway
Max Velocity through Gate 1 (fps)	N/A	N/A	N/A	0.2	0.4	1.0	1.4	2.1	N/A
Max Velocity through Gate 2 (fps)	N/A	N/A	N/A	N/A	N/A	N/A	N/A	N/A	2.7
Time to Drain 97% of Inflow Volume (hours)	45	62	63	64	61	57	54	50	45
Time to Drain 99% of Inflow Volume (hours)	48	69	69	73	72	70	69	67	64
Maximum Ponding Depth (ft)	3.58	6.24	5.88	6.96	7.44	8.07	8.44	8.94	9.37
Area at Maximum Ponding Depth (acres)	0.35	0.51	0.49	0.55	0.58	0.62	0.64	0.67	0.70
Maximum Volume Stored (acre-ft)	0.602	1.752	1.568	2.127	2.397	2.778	3.010	3.338	3.632

# DETENTION BASIN OUTLET STRUCTURE DESIGN

*MHFD-Detention, Version 4.04 (February 2021)*



S-A-V-D Chart Axis Override	X-axis	Left Y-Axis	Right Y-Axis
minimum bound			
maximum bound			

# DETENTION BASIN OUTLET STRUCTURE DESIGN

Outflow Hydrograph Workbook Filename: \_\_\_\_\_

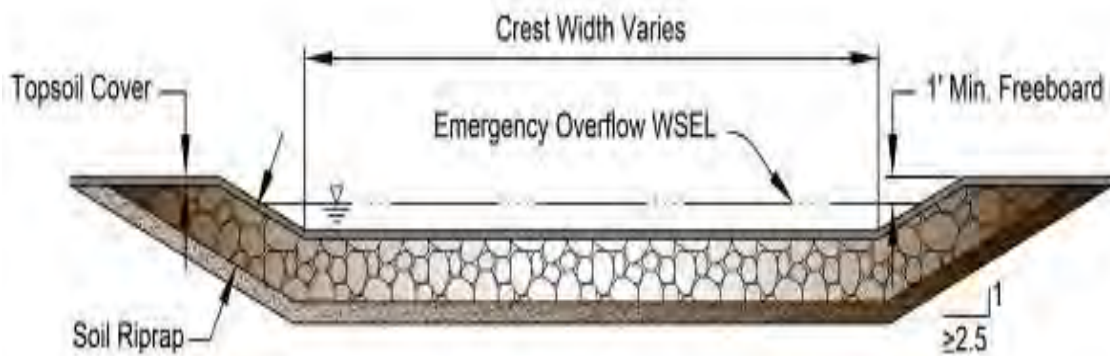
## Inflow Hydrographs

The user can override the calculated inflow hydrographs from this workbook with inflow hydrographs developed in a separate program.

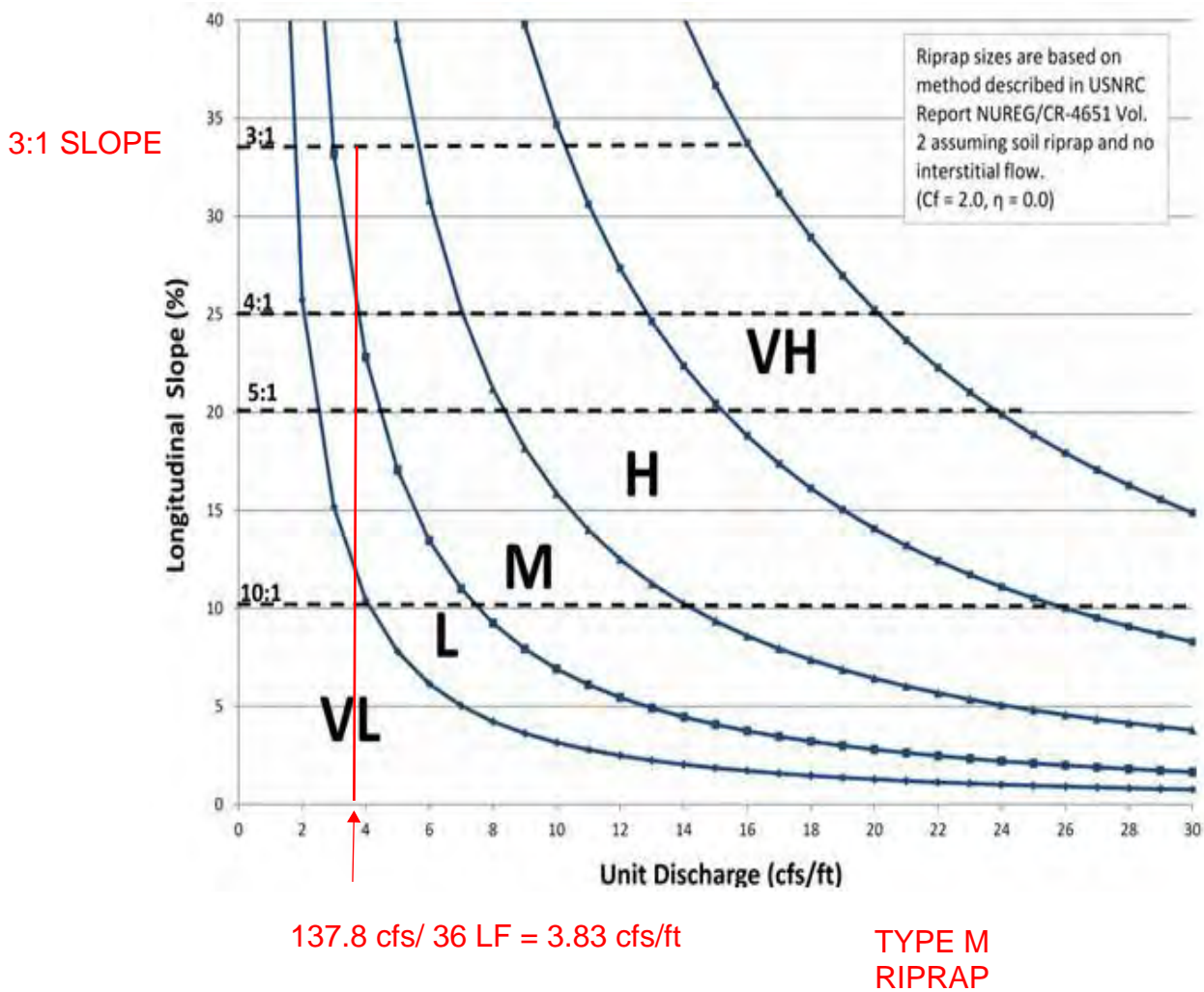
Time Interval	SOURCE	CUHP	CUHP	CUHP	CUHP	CUHP	CUHP	CUHP	CUHP	CUHP
5.00 min	TIME	WQCV [cfs]	EURV [cfs]	2 Year [cfs]	5 Year [cfs]	10 Year [cfs]	25 Year [cfs]	50 Year [cfs]	100 Year [cfs]	500 Year [cfs]
	0:00:00	0.00	0.00	0.00	0.00	0.00	0.00	0.00	0.00	0.00
	0:05:00	0.00	0.00	0.00	0.00	0.00	0.00	0.00	0.00	0.00
	0:10:00	0.00	0.00	0.00	0.00	0.00	0.00	0.25	0.02	0.75
	0:15:00	0.00	0.00	2.17	3.56	4.42	2.97	3.73	3.63	5.17
	0:20:00	0.00	0.00	7.87	10.44	13.12	7.78	9.08	9.72	13.07
	0:25:00	0.00	0.00	19.13	29.54	39.38	18.81	22.41	25.25	38.59
	0:30:00	0.00	0.00	26.48	40.33	50.59	55.34	66.71	76.07	101.60
	0:35:00	0.00	0.00	25.65	38.07	47.11	67.97	80.89	96.81	126.12
	0:40:00	0.00	0.00	22.91	33.25	41.24	66.73	78.86	94.31	122.21
	0:45:00	0.00	0.00	19.53	28.64	36.19	59.75	70.53	86.65	112.19
	0:50:00	0.00	0.00	16.66	24.93	31.18	54.08	63.85	78.30	101.41
	0:55:00	0.00	0.00	14.27	21.23	26.72	46.40	54.91	68.95	89.33
	1:00:00	0.00	0.00	12.36	18.18	23.29	39.28	46.60	60.47	78.50
	1:05:00	0.00	0.00	11.05	16.16	21.11	33.87	40.35	54.07	70.49
	1:10:00	0.00	0.00	9.65	14.68	19.44	28.90	34.55	45.30	59.50
	1:15:00	0.00	0.00	8.37	12.94	17.86	24.72	29.64	37.60	49.80
	1:20:00	0.00	0.00	7.20	11.02	15.43	20.54	24.60	30.22	40.00
	1:25:00	0.00	0.00	6.10	9.23	12.57	16.78	20.04	23.75	31.34
	1:30:00	0.00	0.00	5.13	7.70	10.08	13.11	15.57	18.05	23.75
	1:35:00	0.00	0.00	4.44	6.66	8.45	9.88	11.67	13.19	17.47
	1:40:00	0.00	0.00	4.09	5.76	7.50	7.81	9.23	10.11	13.55
	1:45:00	0.00	0.00	3.93	5.13	6.89	6.58	7.75	8.27	11.15
	1:50:00	0.00	0.00	3.84	4.70	6.45	5.80	6.80	7.01	9.49
	1:55:00	0.00	0.00	3.41	4.38	6.00	5.26	6.14	6.13	8.33
	2:00:00	0.00	0.00	3.02	4.03	5.40	4.92	5.71	5.50	7.49
	2:05:00	0.00	0.00	2.36	3.15	4.19	3.82	4.41	4.12	5.61
	2:10:00	0.00	0.00	1.80	2.37	3.13	2.83	3.25	2.96	4.03
	2:15:00	0.00	0.00	1.36	1.78	2.33	2.11	2.42	2.20	2.98
	2:20:00	0.00	0.00	1.03	1.33	1.72	1.57	1.80	1.64	2.22
	2:25:00	0.00	0.00	0.77	0.98	1.26	1.16	1.32	1.22	1.65
	2:30:00	0.00	0.00	0.56	0.70	0.92	0.84	0.95	0.89	1.20
	2:35:00	0.00	0.00	0.41	0.50	0.67	0.61	0.69	0.65	0.88
	2:40:00	0.00	0.00	0.29	0.35	0.48	0.44	0.50	0.47	0.63
	2:45:00	0.00	0.00	0.19	0.24	0.32	0.30	0.34	0.32	0.43
	2:50:00	0.00	0.00	0.11	0.15	0.19	0.19	0.21	0.20	0.26
	2:55:00	0.00	0.00	0.05	0.08	0.10	0.10	0.11	0.10	0.14
	3:00:00	0.00	0.00	0.02	0.03	0.04	0.04	0.04	0.04	0.05
	3:05:00	0.00	0.00	0.01	0.01	0.01	0.01	0.01	0.01	0.01
	3:10:00	0.00	0.00	0.00	0.00	0.00	0.00	0.00	0.00	0.00
	3:15:00	0.00	0.00	0.00	0.00	0.00	0.00	0.00	0.00	0.00
	3:20:00	0.00	0.00	0.00	0.00	0.00	0.00	0.00	0.00	0.00
	3:25:00	0.00	0.00	0.00	0.00	0.00	0.00	0.00	0.00	0.00
	3:30:00	0.00	0.00	0.00	0.00	0.00	0.00	0.00	0.00	0.00
	3:35:00	0.00	0.00	0.00	0.00	0.00	0.00	0.00	0.00	0.00
	3:40:00	0.00	0.00	0.00	0.00	0.00	0.00	0.00	0.00	0.00
	3:45:00	0.00	0.00	0.00	0.00	0.00	0.00	0.00	0.00	0.00
	3:50:00	0.00	0.00	0.00	0.00	0.00	0.00	0.00	0.00	0.00
	3:55:00	0.00	0.00	0.00	0.00	0.00	0.00	0.00	0.00	0.00
	4:00:00	0.00	0.00	0.00	0.00	0.00	0.00	0.00	0.00	0.00
	4:05:00	0.00	0.00	0.00	0.00	0.00	0.00	0.00	0.00	0.00
	4:10:00	0.00	0.00	0.00	0.00	0.00	0.00	0.00	0.00	0.00
	4:15:00	0.00	0.00	0.00	0.00	0.00	0.00	0.00	0.00	0.00
	4:20:00	0.00	0.00	0.00	0.00	0.00	0.00	0.00	0.00	0.00
	4:25:00	0.00	0.00	0.00	0.00	0.00	0.00	0.00	0.00	0.00
	4:30:00	0.00	0.00	0.00	0.00	0.00	0.00	0.00	0.00	0.00
	4:35:00	0.00	0.00	0.00	0.00	0.00	0.00	0.00	0.00	0.00
	4:40:00	0.00	0.00	0.00	0.00	0.00	0.00	0.00	0.00	0.00
	4:45:00	0.00	0.00	0.00	0.00	0.00	0.00	0.00	0.00	0.00
	4:50:00	0.00	0.00	0.00	0.00	0.00	0.00	0.00	0.00	0.00
	4:55:00	0.00	0.00	0.00	0.00	0.00	0.00	0.00	0.00	0.00
	5:00:00	0.00	0.00	0.00	0.00	0.00	0.00	0.00	0.00	0.00
	5:05:00	0.00	0.00	0.00	0.00	0.00	0.00	0.00	0.00	0.00
	5:10:00	0.00	0.00	0.00	0.00	0.00	0.00	0.00	0.00	0.00
	5:15:00	0.00	0.00	0.00	0.00	0.00	0.00	0.00	0.00	0.00
	5:20:00	0.00	0.00	0.00	0.00	0.00	0.00	0.00	0.00	0.00
	5:25:00	0.00	0.00	0.00	0.00	0.00	0.00	0.00	0.00	0.00
	5:30:00	0.00	0.00	0.00	0.00	0.00	0.00	0.00	0.00	0.00
	5:35:00	0.00	0.00	0.00	0.00	0.00	0.00	0.00	0.00	0.00
	5:40:00	0.00	0.00	0.00	0.00	0.00	0.00	0.00	0.00	0.00
	5:45:00	0.00	0.00	0.00	0.00	0.00	0.00	0.00	0.00	0.00
	5:50:00	0.00	0.00	0.00	0.00	0.00	0.00	0.00	0.00	0.00
	5:55:00	0.00	0.00	0.00	0.00	0.00	0.00	0.00	0.00	0.00
	6:00:00	0.00	0.00	0.00	0.00	0.00	0.00	0.00	0.00	0.00



**Figure 13-12c. Emergency Spillway Protection**

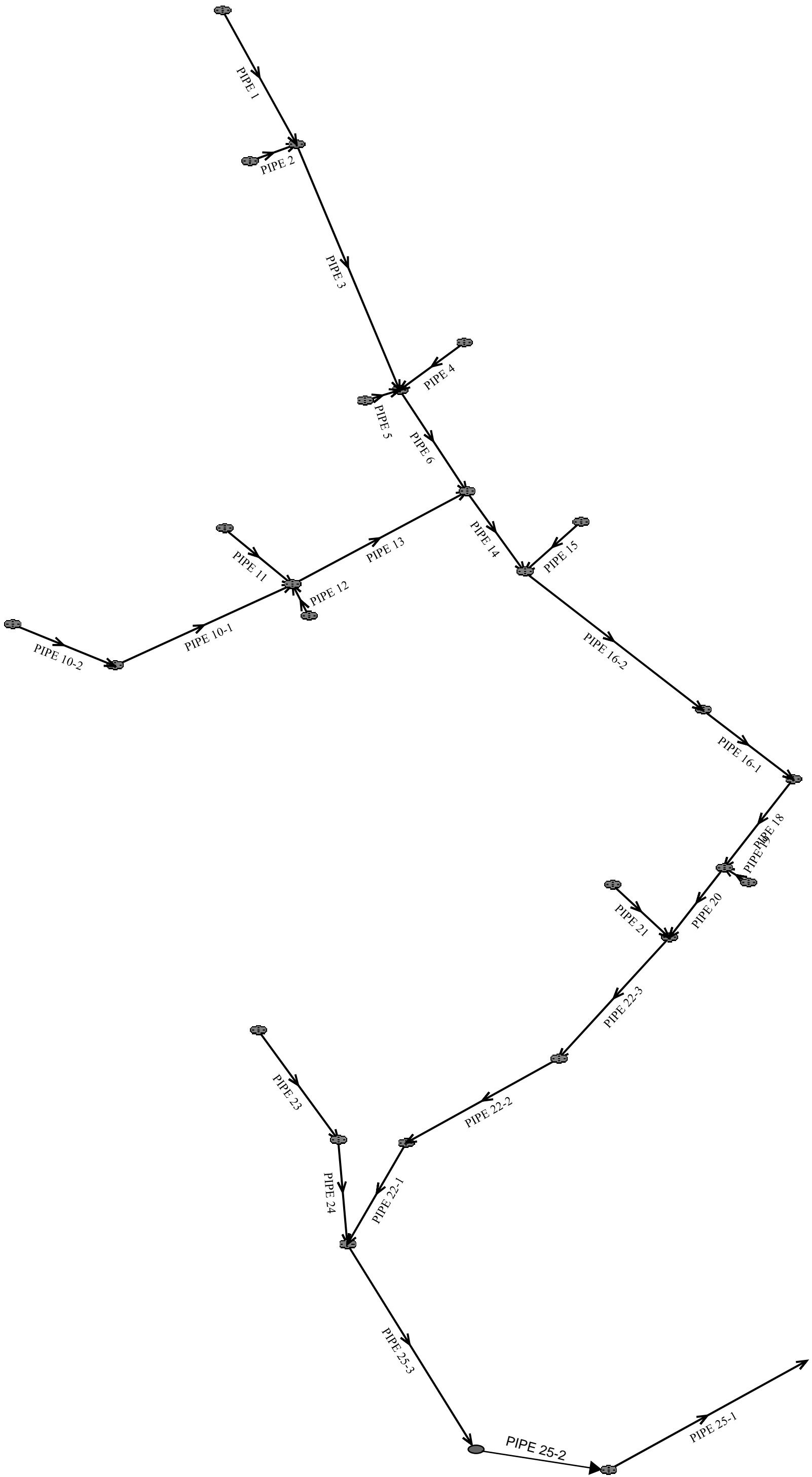


**Figure 13-12d. Riprap Types for Emergency Spillway Protection**





**HYDRAULIC GRADE LINE (HGL)  
CALCULATIONS**



## **System Input Summary**

## **FIL. 7 TO POND A – 100-YR HGL CALCS**

### **Rainfall Parameters**

**Rainfall Return Period:** 100

**Rainfall Calculation Method:** Formula

**One Hour Depth (in):**

**Rainfall Constant "A":** 28.5

**Rainfall Constant "B":** 10

**Rainfall Constant "C":** 0.786

### **Rational Method Constraints**

**Minimum Urban Runoff Coeff.:** 0.20

**Maximum Rural Overland Len. (ft):** 500

**Maximum Urban Overland Len. (ft):** 300

**Used UDFCD Tc. Maximum:** Yes

### **Sizer Constraints**

**Minimum Sewer Size (in):** 18.00

**Maximum Depth to Rise Ratio:** 0.90

**Maximum Flow Velocity (fps):** 18.0

**Minimum Flow Velocity (fps):** 2.0

### **Backwater Calculations:**

**Tailwater Elevation (ft):** 0.00



PIPE 11	7158.95	11.40	0.00	0.00	0.00	0.00	0.00	0.00	0.00	0.00
PIPE 10-1	7160.60	7.10	0.00	0.00	0.00	0.00	0.00	0.00	0.00	0.00
PIPE 10-2	7161.70	7.10	0.00	0.00	0.00	0.00	0.00	0.00	0.00	0.00
PIPE 12	7158.42	6.60	0.00	0.00	0.00	0.00	0.00	0.00	0.00	0.00
PIPE 6	7162.00	48.30	0.00	0.00	0.00	0.00	0.00	0.00	0.00	0.00
PIPE 3	7186.95	27.20	0.00	0.00	0.00	0.00	0.00	0.00	0.00	0.00
PIPE 1	7189.88	13.80	0.00	0.00	0.00	0.00	0.00	0.00	0.00	0.00
PIPE 2	7186.75	13.40	0.00	0.00	0.00	0.00	0.00	0.00	0.00	0.00
PIPE 5	7161.70	6.90	0.00	0.00	0.00	0.00	0.00	0.00	0.00	0.00
PIPE 4	7162.00	15.10	0.00	0.00	0.00	0.00	0.00	0.00	0.00	0.00
PIPE 19	7141.97	2.40	0.00	0.00	0.00	0.00	0.00	0.00	0.00	0.00

### Manhole Output Summary:

Element Name	Local Contribution					Total Design Flow				Comment
	Overland Time (min)	Gutter Time (min)	Basin Tc (min)	Intensity (in/hr)	Local Contrib (cfs)	Coeff. Area	Intensity (in/hr)	Manhole Tc (min)	Peak Flow (cfs)	
OUTFALL 1	0.00	0.00	0.00	0.00	0.00	0.00	0.00	0.00	0.00	
PIPE 25-1	0.00	0.00	0.00	0.00	0.00	0.00	0.00	0.00	126.10	Surface Water Present (Downstream)
PIPE 25-2	0.00	0.00	0.00	0.00	0.00	0.00	0.00	0.00	126.10	
PIPE 25-3	0.00	0.00	0.00	0.00	0.00	0.00	0.00	0.00	126.10	
PIPE 24	0.00	0.00	0.00	0.00	0.00	0.00	0.00	0.00	22.50	



## Sewer Input Summary:

Element Name	Sewer Length (ft)	Elevation			Loss Coefficients			Given Dimensions		
		Downstream Invert (ft)	Slope (%)	Upstream Invert (ft)	Mannings n	Bend Loss	Lateral Loss	Cross Section	Rise (ft or in)	Span (ft or in)
PIPE 25-1	144.95	7111.15	2.0	7114.05	0.013	0.03	1.00	CIRCULAR	48.00 in	48.00 in
PIPE 25-2	45.42	7114.05	2.0	7114.96	0.013	0.29	0.44	CIRCULAR	48.00 in	48.00 in
PIPE 25-3	128.05	7118.48	4.5	7124.24	0.013	0.38	0.44	CIRCULAR	48.00 in	48.00 in
PIPE 24	14.63	7131.50	1.0	7131.65	0.013	0.09	0.72	CIRCULAR	24.00 in	24.00 in
PIPE 23	35.34	7131.95	0.5	7132.13	0.013	0.10	0.72	CIRCULAR	24.00 in	24.00 in
PIPE 22-1	26.97	7129.51	0.5	7129.64	0.013	0.38	0.00	CIRCULAR	48.00 in	48.00 in
PIPE 22-2	148.48	7129.64	0.5	7130.38	0.013	0.16	0.58	CIRCULAR	48.00 in	48.00 in
PIPE 22-3	142.91	7130.38	0.5	7131.09	0.013	0.08	0.73	CIRCULAR	48.00 in	48.00 in
PIPE 21	27.05	7133.60	1.0	7133.87	0.013	1.32	0.00	CIRCULAR	18.00 in	18.00 in
PIPE 20	14.64	7131.60	0.5	7131.67	0.013	0.05	1.00	CIRCULAR	42.00 in	42.00 in
PIPE 18	107.76	7131.97	0.5	7132.51	0.013	0.05	1.00	CIRCULAR	42.00 in	42.00 in
PIPE 17	31.29	7134.50	0.5	7134.66	0.013	0.19	0.00	CIRCULAR	18.00 in	18.00 in
PIPE 16-1	57.50	7133.02	1.8	7134.05	0.013	1.32	0.25	CIRCULAR	36.00 in	36.00 in
PIPE 16-2	187.98	7134.35	6.0	7145.63	0.013	0.05	1.00	CIRCULAR	36.00 in	36.00 in
PIPE 15	29.39	7146.93	6.2	7148.75	0.013	1.32	0.00	CIRCULAR	24.00 in	24.00 in
PIPE 14	35.14	7145.93	6.0	7148.04	0.013	0.05	0.86	CIRCULAR	36.00 in	36.00 in
PIPE 13	107.03	7148.53	0.5	7149.07	0.013	1.32	0.00	CIRCULAR	30.00 in	30.00 in
PIPE 11	27.58	7150.07	0.5	7150.21	0.013	1.06	0.00	CIRCULAR	18.00 in	18.00 in
PIPE 10-1	97.56	7150.07	0.5	7150.56	0.013	0.05	1.00	CIRCULAR	18.00 in	18.00 in
PIPE 10-2	38.09	7150.84	5.9	7153.09	0.013	0.38	0.44	CIRCULAR	18.00 in	18.00 in

PIPE 12	3.45	7150.07	5.8	7150.27	0.013	1.32	0.00	CIRCULAR	18.00 in	18.00 in
PIPE 6	47.89	7148.56	3.7	7150.33	0.013	0.05	1.00	CIRCULAR	30.00 in	30.00 in
PIPE 3	357.40	7151.33	6.9	7175.99	0.013	0.05	1.00	CIRCULAR	24.00 in	24.00 in
PIPE 1	78.51	7177.50	3.9	7180.56	0.013	0.05	0.86	CIRCULAR	18.00 in	18.00 in
PIPE 2	3.63	7177.49	6.3	7177.72	0.013	1.32	0.00	CIRCULAR	18.00 in	18.00 in
PIPE 5	3.63	7151.83	10.2	7152.20	0.013	1.32	0.00	CIRCULAR	18.00 in	18.00 in
PIPE 4	27.51	7151.34	4.0	7152.44	0.013	0.99	0.00	CIRCULAR	24.00 in	24.00 in
PIPE 19	3.04	7133.97	1.0	7134.00	0.013	1.32	0.00	CIRCULAR	18.00 in	18.00 in

## Sewer Flow Summary:

Element Name	Full Flow Capacity		Critical Flow		Normal Flow				Flow (cfs)	Surcharged Length (ft)	Comment
	Flow (cfs)	Velocity (fps)	Depth (in)	Velocity (fps)	Depth (in)	Velocity (fps)	Froude Number	Flow Condition			
PIPE 25-1	203.72	16.21	40.42	11.17	27.33	17.07	2.20	Supercritical	126.10	0.00	
PIPE 25-2	203.89	16.22	40.42	11.17	27.31	17.08	2.20	Pressurized	126.10	45.42	
PIPE 25-3	305.53	24.31	40.42	11.17	21.49	23.15	3.49	Supercritical	126.10	0.00	Velocity is Too High
PIPE 24	22.68	7.22	20.29	7.94	19.50	8.23	1.10	Supercritical	22.50	0.00	
PIPE 23	16.04	5.11	16.81	6.43	18.52	5.81	0.82	Pressurized	15.10	35.34	
PIPE 22-1	101.84	8.10	48.00	8.51	48.00	8.51	0.00	Pressurized	106.90	26.97	
PIPE 22-2	101.84	8.10	48.00	8.51	48.00	8.51	0.00	Pressurized	106.90	148.48	
PIPE 22-3	101.84	8.10	48.00	8.51	48.00	8.51	0.00	Pressurized	106.90	142.91	
PIPE 21	10.53	5.96	11.83	5.28	10.23	6.27	1.32	Pressurized	6.50	27.05	
PIPE 20	71.33	7.41	42.00	10.47	42.00	10.47	0.00	Pressurized	100.70	14.64	



PIPE 18	71.33	7.41	42.00	10.31	42.00	10.31	0.00	Pressurized	99.20	107.76	
PIPE 17	7.45	4.21	18.00	7.41	18.00	7.41	0.00	Pressurized	13.10	31.29	
PIPE 16-1	89.73	12.69	33.89	12.56	28.47	14.46	1.63	Pressurized	86.70	57.50	
PIPE 16-2	163.82	23.18	33.89	12.56	18.62	23.50	3.73	Supercritical Jump	86.70	130.64	Velocity is Too High
PIPE 15	56.48	17.98	16.52	6.33	8.32	15.08	3.73	Pressurized	14.60	29.39	
PIPE 14	163.82	23.18	32.22	10.81	16.72	22.44	3.82	Supercritical Jump	72.10	28.63	Velocity is Too High
PIPE 13	29.08	5.92	20.19	6.94	21.03	6.64	0.92	Pressurized	24.40	107.03	
PIPE 11	7.45	4.21	18.00	6.45	18.00	6.45	0.00	Pressurized	11.40	27.58	
PIPE 10-1	7.45	4.21	12.38	5.48	14.05	4.80	0.77	Pressurized	7.10	97.56	
PIPE 10-2	25.58	14.48	12.38	5.48	6.48	12.39	3.46	Supercritical Jump	7.10	30.33	
PIPE 12	25.37	14.35	11.93	5.31	6.27	12.07	3.44	Pressurized	6.60	3.45	
PIPE 6	79.11	16.12	27.32	10.29	16.93	16.91	2.78	Supercritical	48.30	0.00	
PIPE 3	59.58	18.97	21.75	9.09	11.38	18.53	3.81	Supercritical	27.20	0.00	Velocity is Too High
PIPE 1	20.80	11.77	16.51	8.13	10.71	12.59	2.57	Supercritical	13.80	0.00	
PIPE 2	26.44	14.96	16.37	7.94	9.07	15.01	3.43	Supercritical	13.40	0.00	
PIPE 5	33.64	19.04	12.20	5.41	5.53	14.97	4.57	Supercritical	6.90	0.00	
PIPE 4	45.37	14.44	16.81	6.43	9.54	12.98	2.97	Pressurized	15.10	27.51	
PIPE 19	10.53	5.96	7.03	3.75	5.84	4.83	1.43	Pressurized	2.40	3.04	

- A Froude number of 0 indicates that pressured flow occurs (adverse slope or undersized pipe).
- If the sewer is not pressurized, full flow represents the maximum gravity flow in the sewer.
- If the sewer is pressurized, full flow represents the pressurized flow conditions.

## Sewer Sizing Summary:

			Existing		Calculated		Used			
Element Name	Peak Flow (cfs)	Cross Section	Rise	Span	Rise	Span	Rise	Span	Area (ft <sup>2</sup> )	Comment
PIPE 25-1	126.10	CIRCULAR	48.00 in	48.00 in	42.00 in	42.00 in	48.00 in	48.00 in	12.57	
PIPE 25-2	126.10	CIRCULAR	48.00 in	48.00 in	42.00 in	42.00 in	48.00 in	48.00 in	12.57	
PIPE 25-3	126.10	CIRCULAR	48.00 in	48.00 in	36.00 in	36.00 in	48.00 in	48.00 in	12.57	
PIPE 24	22.50	CIRCULAR	24.00 in	24.00 in	24.00 in	24.00 in	24.00 in	24.00 in	3.14	
PIPE 23	15.10	CIRCULAR	24.00 in	24.00 in	24.00 in	24.00 in	24.00 in	24.00 in	3.14	
PIPE 22-1	106.90	CIRCULAR	48.00 in	48.00 in	54.00 in	54.00 in	48.00 in	48.00 in	12.57	Existing height is smaller than the suggested height. Existing width is smaller than the suggested width. Exceeds max. Depth/Rise
PIPE 22-2	106.90	CIRCULAR	48.00 in	48.00 in	54.00 in	54.00 in	48.00 in	48.00 in	12.57	Existing height is smaller than the suggested height. Existing width is smaller than the suggested width. Exceeds max. Depth/Rise
PIPE 22-3	106.90	CIRCULAR	48.00 in	48.00 in	54.00 in	54.00 in	48.00 in	48.00 in	12.57	Existing height is smaller than the suggested height. Existing width is smaller than the suggested width. Exceeds max. Depth/Rise
PIPE 21	6.50	CIRCULAR	18.00 in	18.00 in	18.00 in	18.00 in	18.00 in	18.00 in	1.77	
PIPE 20	100.70	CIRCULAR	42.00 in	42.00 in	48.00 in	48.00 in	42.00 in	42.00 in	9.62	Existing height is smaller than the suggested height.

										Existing width is smaller than the suggested width. Exceeds max. Depth/Rise
PIPE 18	99.20	CIRCULAR	42.00 in	42.00 in	48.00 in	48.00 in	42.00 in	42.00 in	9.62	Existing height is smaller than the suggested height. Existing width is smaller than the suggested width. Exceeds max. Depth/Rise
PIPE 17	13.10	CIRCULAR	18.00 in	18.00 in	24.00 in	24.00 in	18.00 in	18.00 in	1.77	Existing height is smaller than the suggested height. Existing width is smaller than the suggested width. Exceeds max. Depth/Rise
PIPE 16-1	86.70	CIRCULAR	36.00 in	36.00 in	36.00 in	36.00 in	36.00 in	36.00 in	7.07	
PIPE 16-2	86.70	CIRCULAR	36.00 in	36.00 in	30.00 in	30.00 in	36.00 in	36.00 in	7.07	
PIPE 15	14.60	CIRCULAR	24.00 in	24.00 in	18.00 in	18.00 in	24.00 in	24.00 in	3.14	
PIPE 14	72.10	CIRCULAR	36.00 in	36.00 in	27.00 in	27.00 in	36.00 in	36.00 in	7.07	
PIPE 13	24.40	CIRCULAR	30.00 in	30.00 in	30.00 in	30.00 in	30.00 in	30.00 in	4.91	
PIPE 11	11.40	CIRCULAR	18.00 in	18.00 in	24.00 in	24.00 in	18.00 in	18.00 in	1.77	Existing height is smaller than the suggested height. Existing width is smaller than the suggested width. Exceeds max. Depth/Rise
PIPE 10-1	7.10	CIRCULAR	18.00 in	18.00 in	18.00 in	18.00 in	18.00 in	18.00 in	1.77	
PIPE 10-2	7.10	CIRCULAR	18.00 in	18.00 in	18.00 in	18.00 in	18.00 in	18.00 in	1.77	
PIPE 12	6.60	CIRCULAR	18.00 in	18.00 in	18.00 in	18.00 in	18.00 in	18.00 in	1.77	
PIPE 6	48.30	CIRCULAR	30.00 in	30.00 in	27.00 in	27.00 in	30.00 in	30.00 in	4.91	
PIPE 3	27.20	CIRCULAR	24.00 in	24.00 in	18.00 in	18.00 in	24.00 in	24.00 in	3.14	

PIPE 1	13.80	CIRCULAR	18.00 in	18.00 in	18.00 in	18.00 in	18.00 in	18.00 in	18.00 in	1.77	
PIPE 2	13.40	CIRCULAR	18.00 in	18.00 in	18.00 in	18.00 in	18.00 in	18.00 in	18.00 in	1.77	
PIPE 5	6.90	CIRCULAR	18.00 in	18.00 in	18.00 in	18.00 in	18.00 in	18.00 in	18.00 in	1.77	
PIPE 4	15.10	CIRCULAR	24.00 in	24.00 in	18.00 in	18.00 in	24.00 in	24.00 in	24.00 in	3.14	
PIPE 19	2.40	CIRCULAR	18.00 in	18.00 in	18.00 in	18.00 in	18.00 in	18.00 in	18.00 in	1.77	

- Calculated diameter was determined by sewer hydraulic capacity rounded up to the nearest commercially available size.
- Sewer sizes should not decrease downstream.
- All hydraulics were calculated using the 'Used' parameters.

## Grade Line Summary:

**Tailwater Elevation (ft): 0.00**

Element Name	Invert Elev.		Downstream Manhole Losses		HGL		EGL		
	Downstream (ft)	Upstream (ft)	Bend Loss (ft)	Lateral Loss (ft)	Downstream (ft)	Upstream (ft)	Downstream (ft)	Friction Loss (ft)	Upstream (ft)
PIPE 25-1	7111.15	7114.05	0.00	0.00	7113.43	7117.42	7117.95	1.40	7119.35
PIPE 25-2	7114.05	7114.96	0.45	0.88	7119.12	7119.47	7120.68	0.35	7121.03
PIPE 25-3	7118.48	7124.24	0.59	0.88	7120.94	7127.61	7128.59	0.96	7129.54
PIPE 24	7131.50	7131.65	0.07	0.99	7133.13	7133.34	7134.18	0.14	7134.32
PIPE 23	7131.95	7132.13	0.04	0.54	7134.54	7134.69	7134.89	0.16	7135.05
PIPE 22-1	7129.51	7129.64	0.43	0.00	7133.51	7133.65	7134.63	0.15	7134.78

PIPE 22-2	7129.64	7130.38	0.18	0.47	7134.31	7135.12	7135.43	0.82	7136.25
PIPE 22-3	7130.38	7131.09	0.09	0.30	7135.52	7136.30	7136.64	0.79	7137.43
PIPE 21	7133.60	7133.87	0.28	0.00	7137.49	7137.60	7137.71	0.10	7137.81
PIPE 20	7131.60	7131.67	0.09	0.00	7136.39	7136.53	7138.09	0.15	7138.24
PIPE 18	7131.97	7132.51	0.08	0.05	7136.72	7137.76	7138.37	1.04	7139.41
PIPE 17	7134.50	7134.66	0.16	0.00	7138.72	7139.20	7139.57	0.48	7140.06
PIPE 16-1	7133.02	7134.05	3.08	1.07	7141.91	7142.88	7144.25	0.97	7145.21
PIPE 16-2	7134.35	7145.63	0.12	0.00	7142.99	7148.45	7145.33	5.58	7150.90
PIPE 15	7146.93	7148.75	0.44	0.00	7151.01	7151.13	7151.35	0.12	7151.47
PIPE 14	7145.93	7148.04	0.08	0.95	7150.32	7150.72	7151.93	0.61	7152.54
PIPE 13	7148.53	7149.07	0.51	0.00	7152.66	7153.04	7153.04	0.38	7153.42
PIPE 11	7150.07	7150.21	0.68	0.00	7153.72	7154.05	7154.37	0.32	7154.69
PIPE 10-1	7150.07	7150.56	0.01	0.13	7153.32	7153.76	7153.57	0.44	7154.01
PIPE 10-2	7150.84	7153.09	0.10	0.14	7153.99	7154.12	7154.25	0.34	7154.59
PIPE 12	7150.07	7150.27	0.29	0.00	7153.49	7153.50	7153.71	0.01	7153.72
PIPE 6	7148.56	7150.33	0.08	0.11	7150.91	7152.91	7154.41	0.00	7154.41
PIPE 3	7151.33	7175.99	0.06	0.34	7153.31	7177.80	7157.61	21.47	7179.09
PIPE 1	7177.50	7180.56	0.05	0.35	7178.39	7181.94	7180.85	2.11	7182.96
PIPE 2	7177.49	7177.72	1.18	0.00	7178.98	7180.85	7181.75	0.00	7181.75
PIPE 5	7151.83	7152.20	0.31	0.00	7153.22	7155.53	7155.77	0.00	7155.77
PIPE 4	7151.34	7152.44	0.36	0.00	7154.41	7154.53	7154.77	0.12	7154.89
PIPE 19	7133.97	7134.00	0.04	0.00	7138.25	7138.25	7138.27	0.00	7138.28

- Bend and Lateral losses only apply when there is an outgoing sewer. The system outfall, sewer #0, is not considered a sewer.
- Bend loss = Bend K \* V<sub>fi</sub> ^ 2/(2\*g)

- Lateral loss =  $V_{fo}^2 / (2 * g) - \text{Junction Loss } K * V_{fi}^2 / (2 * g)$ .
- Friction loss is always Upstream EGL - Downstream EGL.

## Excavation Estimate:

The trench side slope is 1.0 ft/ft

The minimum trench width is 2.00 ft

Element Name	Length (ft)	Wall (in)	Bedding (in)	Bottom Width (ft)	Downstream			Upstream			Volume (cu. yd)	Comment
					Top Width (ft)	Trench Depth (ft)	Cover (ft)	Top Width (ft)	Trench Depth (ft)	Cover (ft)		
PIPE 25-1	144.95	5.00	6.00	7.83	0.00	0.00	0.00	17.68	11.26	5.92	301.75	Sewer Too Shallow
PIPE 25-2	45.42	5.00	6.00	7.83	17.68	11.26	5.92	22.88	13.86	8.52	233.46	
PIPE 25-3	128.05	5.00	6.00	7.83	15.84	10.34	5.01	31.86	18.35	13.01	913.11	
PIPE 24	14.63	3.00	4.00	5.50	19.33	10.75	7.92	18.30	10.23	7.40	55.32	
PIPE 23	35.34	3.00	4.00	5.50	17.69	9.93	7.10	17.34	9.75	6.92	118.11	
PIPE 22-1	26.97	5.00	6.00	7.83	21.33	13.08	7.75	21.50	13.17	7.83	148.76	
PIPE 22-2	148.48	5.00	6.00	7.83	21.50	13.17	7.84	23.06	13.95	8.61	871.90	
PIPE 22-3	142.91	5.00	6.00	7.83	23.07	13.95	8.62	19.34	12.09	6.75	780.97	
PIPE 21	27.05	2.50	4.00	4.92	16.82	9.20	6.95	16.10	8.84	6.59	77.85	
PIPE 20	14.64	4.50	6.00	7.25	18.83	11.54	6.79	18.56	11.41	6.66	62.85	
PIPE 18	107.76	4.50	6.00	7.25	17.96	11.10	6.35	19.08	11.67	6.92	456.43	
PIPE 17	31.29	2.50	4.00	4.92	17.09	9.34	7.09	17.52	9.55	7.30	98.30	
PIPE 16-1	57.50	4.00	6.00	6.67	18.57	11.12	6.95	21.28	12.47	8.31	262.04	

PIPE 16-2	187.98	4.00	6.00	6.67	20.68	12.17	8.01	23.04	13.35	9.19	996.53	
PIPE 15	29.39	3.00	4.00	5.50	21.44	11.81	8.97	17.90	10.03	7.20	120.89	
PIPE 14	35.14	4.00	6.00	6.67	22.44	13.05	8.89	21.52	12.59	8.43	187.61	
PIPE 13	107.03	3.50	6.00	6.08	21.03	12.06	8.47	17.70	10.39	6.81	448.24	
PIPE 11	27.58	2.50	4.00	4.92	16.70	9.14	6.89	16.98	9.28	7.03	82.56	
PIPE 10-1	97.56	2.50	4.00	4.92	16.70	9.14	6.89	19.58	10.58	8.33	334.96	
PIPE 10-2	38.09	2.50	4.00	4.92	19.01	10.30	8.05	16.72	9.15	6.90	127.07	
PIPE 12	3.45	2.50	4.00	4.92	16.70	9.14	6.89	15.80	8.69	6.44	9.71	
PIPE 6	47.89	3.50	6.00	6.08	20.98	12.03	8.45	21.84	12.46	8.88	236.42	
PIPE 3	357.40	3.00	4.00	5.50	20.34	11.25	8.42	20.92	11.54	8.71	1587.75	
PIPE 1	78.51	2.50	4.00	4.92	18.40	9.99	7.74	18.14	9.86	7.61	271.60	
PIPE 2	3.63	2.50	4.00	4.92	18.42	10.00	7.75	17.56	9.57	7.32	12.22	
PIPE 5	3.63	2.50	4.00	4.92	19.84	10.71	8.46	18.50	10.04	7.79	13.70	
PIPE 4	27.51	3.00	4.00	5.50	20.32	11.24	8.41	18.12	10.14	7.31	108.19	
PIPE 19	3.04	2.50	4.00	4.92	15.96	8.77	6.52	15.44	8.51	6.26	8.06	

**Total earth volume for sewer trenches = 8926 cubic yards.**

- The trench was estimated to have a bottom width equal to the outer pipe diameter plus 36 inches.
- If the calculated width of the trench bottom is less than the minimum acceptable width, the minimum acceptable width was used.
- The sewer wall thickness is equal to:  $(\text{equivalent diameter in inches}/12)+1$  inches
- The sewer bedding thickness is equal to:
  - Four inches for pipes less than 33 inches.
  - Six inches for pipes less than 60 inches.
  - Eight inches for all larger sizes.

# **System Input Summary- SOUTH SYSTEM INTO FILING 6 STORM SYSTEM**

## **Rainfall Parameters**



PIPES WITHIN  
FILING 7 LIMITS

**Rainfall Return Period:** 100

**Rainfall Calculation Method:** Formula

**One Hour Depth (in):**

**Rainfall Constant "A":** 28.5

**Rainfall Constant "B":** 10

**Rainfall Constant "C":** 0.786

## **Rational Method Constraints**

**Minimum Urban Runoff Coeff.:** 0.20

**Maximum Rural Overland Len. (ft):** 500

**Maximum Urban Overland Len. (ft):** 300

**Used UDFCD Tc. Maximum:** Yes

## **Sizer Constraints**

**Minimum Sewer Size (in):** 18.00

**Maximum Depth to Rise Ratio:** 0.90

**Maximum Flow Velocity (fps):** 18.0

**Minimum Flow Velocity (fps):** 2.0

## **Backwater Calculations:**

**Tailwater Elevation (ft):** 0.00







PIPE 9-1	0.00	0.00	0.00	0.00	0.00	0.00	0.00	0.00	56.90	
PIPE 9-2	0.00	0.00	0.00	0.00	0.00	0.00	0.00	0.00	56.90	
PIPE 9-3	0.00	0.00	0.00	0.00	0.00	0.00	0.00	0.00	56.90	
PIPE 9-4	0.00	0.00	0.00	0.00	0.00	0.00	0.00	0.00	56.90	
PIPE 9-5	0.00	0.00	0.00	0.00	0.00	0.00	0.00	0.00	56.90	
PIPE 9-6	0.00	0.00	0.00	0.00	0.00	0.00	0.00	0.00	56.90	
PIPE 9-7	0.00	0.00	0.00	0.00	0.00	0.00	0.00	0.00	56.90	
PIPE 9-8	0.00	0.00	0.00	0.00	0.00	0.00	0.00	0.00	56.90	
PIPE 7	0.00	0.00	0.00	0.00	0.00	0.00	0.00	0.00	18.90	
PIPE 6B-1	0.00	0.00	0.00	0.00	0.00	0.00	0.00	0.00	30.90	
PIPE 6B-2	0.00	0.00	0.00	0.00	0.00	0.00	0.00	0.00	30.90	
PIPE 39-1	0.00	0.00	0.00	0.00	0.00	0.00	0.00	0.00	30.90	
PIPE 39-2	0.00	0.00	0.00	0.00	0.00	0.00	0.00	0.00	30.90	
PIPE 39-3	0.00	0.00	0.00	0.00	0.00	0.00	0.00	0.00	30.90	
PIPE 37	0.00	0.00	0.00	0.00	0.00	0.00	0.00	0.00	13.10	
PIPE 38	0.00	0.00	0.00	0.00	0.00	0.00	0.00	0.00	3.70	
PIPE 36-1	0.00	0.00	0.00	0.00	0.00	0.00	0.00	0.00	14.90	
PIPE 36-2	0.00	0.00	0.00	0.00	0.00	0.00	0.00	0.00	14.90	
PIPE 36-3	0.00	0.00	0.00	0.00	0.00	0.00	0.00	0.00	14.90	
PIPE 8	0.00	0.00	0.00	0.00	0.00	0.00	0.00	0.00	8.30	

### Sewer Input Summary:

	Elevation	Loss Coefficients	Given Dimensions
--	-----------	-------------------	------------------

<b>Element Name</b>	<b>Sewer Length (ft)</b>	<b>Downstream Invert (ft)</b>	<b>Slope (%)</b>	<b>Upstream Invert (ft)</b>	<b>Mannings n</b>	<b>Bend Loss</b>	<b>Lateral Loss</b>	<b>Cross Section</b>	<b>Rise (ft or in)</b>	<b>Span (ft or in)</b>
PIPE 14	72.62	7055.59	0.5	7055.95	0.013	0.03	1.00	CIRCULAR	42.00 in	42.00 in
PIPE 13	17.38	7057.45	10.0	7059.19	0.013	1.32	0.00	CIRCULAR	24.00 in	24.00 in
PIPE 12-1	125.04	7056.15	0.5	7056.78	0.013	0.05	1.00	CIRCULAR	42.00 in	42.00 in
PIPE 12-2	63.60	7056.77	0.5	7057.09	0.013	0.54	0.36	CIRCULAR	42.00 in	42.00 in
PIPE 10	29.31	7059.10	1.0	7059.39	0.013	0.83	0.00	CIRCULAR	18.00 in	18.00 in
PIPE 11	5.96	7059.09	10.1	7059.69	0.013	0.38	0.00	CIRCULAR	18.00 in	18.00 in
PIPE 9-1	178.52	7057.59	1.4	7060.09	0.013	0.05	1.00	CIRCULAR	36.00 in	36.00 in
PIPE 9-2	61.53	7060.29	1.1	7060.97	0.013	0.10	0.73	CIRCULAR	36.00 in	36.00 in
PIPE 9-3	55.87	7060.97	1.1	7061.58	0.013	0.08	0.77	CIRCULAR	36.00 in	36.00 in
PIPE 9-4	49.39	7061.59	1.1	7062.13	0.013	0.08	0.77	CIRCULAR	36.00 in	36.00 in
PIPE 9-5	59.96	7062.33	1.0	7062.93	0.013	0.08	0.77	CIRCULAR	36.00 in	36.00 in
PIPE 9-6	46.32	7062.93	1.0	7063.39	0.013	0.08	0.77	CIRCULAR	36.00 in	36.00 in
PIPE 9-7	92.93	7063.39	1.0	7064.32	0.013	0.08	0.77	CIRCULAR	36.00 in	36.00 in
PIPE 9-8	75.46	7064.52	0.5	7064.90	0.013	0.90	0.28	CIRCULAR	36.00 in	36.00 in
PIPE 7	27.37	7065.90	1.0	7066.17	0.013	1.32	0.00	CIRCULAR	24.00 in	24.00 in
PIPE 6B-1	39.51	7065.39	0.5	7065.59	0.013	0.05	1.00	CIRCULAR	30.00 in	30.00 in
PIPE 6B-2	45.39	7065.59	0.5	7065.82	0.013	0.05	0.84	CIRCULAR	30.00 in	30.00 in
PIPE 39-1	53.80	7066.12	2.3	7067.36	0.013	0.05	0.84	CIRCULAR	30.00 in	30.00 in
PIPE 39-2	64.14	7067.35	2.3	7068.83	0.013	0.05	0.81	CIRCULAR	30.00 in	30.00 in
PIPE 39-3	139.94	7068.83	2.3	7072.05	0.013	0.05	0.84	CIRCULAR	30.00 in	30.00 in
PIPE 37	26.71	7072.55	1.0	7072.82	0.013	1.32	0.00	CIRCULAR	24.00 in	24.00 in
PIPE 38	3.63	7073.05	10.2	7073.42	0.013	1.32	0.00	CIRCULAR	18.00 in	18.00 in

PIPE 36-1	89.40	7072.56	6.0	7077.92	0.013	0.05	1.00	CIRCULAR	24.00 in	24.00 in
PIPE 36-2	219.12	7078.22	7.7	7095.09	0.013	0.05	1.00	CIRCULAR	24.00 in	24.00 in
PIPE 36-3	38.56	7095.40	7.7	7098.37	0.013	0.38	0.44	CIRCULAR	24.00 in	24.00 in
PIPE 8	2.97	7066.40	9.8	7066.69	0.013	1.32	0.00	CIRCULAR	18.00 in	18.00 in

## Sewer Flow Summary:

Element Name	Full Flow Capacity		Critical Flow		Normal Flow				Flow (cfs)	Surcharged Length (ft)	Comment
	Flow (cfs)	Velocity (fps)	Depth (in)	Velocity (fps)	Depth (in)	Velocity (fps)	Froude Number	Flow Condition			
PIPE 14	71.33	7.41	42.00	8.07	42.00	8.07	0.00	Pressurized	77.60	72.62	
PIPE 13	71.73	22.83	16.05	6.18	7.13	17.63	4.75	Supercritical Jump	13.80	12.16	
PIPE 12-1	71.33	7.41	30.49	8.78	31.77	8.41	0.92	Pressurized	65.70	125.04	
PIPE 12-2	71.33	7.41	30.49	8.78	31.77	8.41	0.92	Pressurized	65.70	63.60	
PIPE 10	10.53	5.96	12.20	5.41	10.62	6.36	1.31	Pressurized	6.90	29.31	
PIPE 11	33.47	18.94	10.75	4.91	4.89	13.91	4.55	Pressurized	5.40	5.96	
PIPE 9-1	79.13	11.19	29.33	9.23	22.60	12.18	1.69	Pressurized	56.90	178.52	
PIPE 9-2	70.14	9.92	29.33	9.23	24.61	11.05	1.43	Supercritical Jump	56.90	53.51	
PIPE 9-3	70.14	9.92	29.33	9.23	24.61	11.05	1.43	Pressurized	56.90	55.87	
PIPE 9-4	70.14	9.92	29.33	9.23	24.61	11.05	1.43	Pressurized	56.90	49.39	
PIPE 9-5	66.88	9.46	29.33	9.23	25.51	10.62	1.34	Pressurized	56.90	59.96	
PIPE 9-6	66.88	9.46	29.33	9.23	25.51	10.62	1.34	Pressurized	56.90	46.32	

PIPE 9-7	66.88	9.46	29.33	9.23	25.51	10.62	1.34	Pressurized	56.90	92.93	
PIPE 9-8	47.29	6.69	36.00	8.05	36.00	8.05	0.00	Pressurized	56.90	75.46	
PIPE 7	22.68	7.22	18.77	7.17	16.74	8.08	1.26	Pressurized	18.90	27.37	
PIPE 6B-1	29.08	5.92	30.00	6.29	30.00	6.29	0.00	Pressurized	30.90	39.51	
PIPE 6B-2	29.08	5.92	30.00	6.29	30.00	6.29	0.00	Pressurized	30.90	45.39	
PIPE 39-1	62.37	12.71	22.73	7.74	14.92	12.68	2.26	Pressurized	30.90	53.80	
PIPE 39-2	62.37	12.71	22.73	7.74	14.92	12.68	2.26	Pressurized	30.90	64.14	
PIPE 39-3	62.37	12.71	22.73	7.74	14.92	12.68	2.26	Supercritical Jump	30.90	56.65	
PIPE 37	22.68	7.22	15.63	6.05	13.09	7.48	1.41	Pressurized	13.10	26.71	
PIPE 38	33.64	19.04	8.82	4.30	4.03	12.52	4.54	Supercritical	3.70	0.00	
PIPE 36-1	55.56	17.69	16.69	6.39	8.49	14.99	3.66	Supercritical	14.90	0.00	
PIPE 36-2	62.94	20.04	16.69	6.39	7.95	16.40	4.16	Supercritical	14.90	0.00	
PIPE 36-3	62.94	20.04	16.69	6.39	7.95	16.40	4.16	Supercritical	14.90	0.00	
PIPE 8	32.97	18.66	13.39	5.89	6.16	15.54	4.47	Pressurized	8.30	2.97	

- A Froude number of 0 indicates that pressured flow occurs (adverse slope or undersized pipe).
- If the sewer is not pressurized, full flow represents the maximum gravity flow in the sewer.
- If the sewer is pressurized, full flow represents the pressurized flow conditions.

### Sewer Sizing Summary:

	Existing	Calculated	Used	
--	----------	------------	------	--

Element Name	Peak Flow (cfs)	Cross Section	Rise	Span	Rise	Span	Rise	Span	Area (ft <sup>2</sup> )	Comment
PIPE 14	77.60	CIRCULAR	42.00 in	42.00 in	48.00 in	48.00 in	42.00 in	42.00 in	9.62	Existing height is smaller than the suggested height. Existing width is smaller than the suggested width. Exceeds max. Depth/Rise
PIPE 13	13.80	CIRCULAR	24.00 in	24.00 in	18.00 in	18.00 in	24.00 in	24.00 in	3.14	
PIPE 12-1	65.70	CIRCULAR	42.00 in	42.00 in	42.00 in	42.00 in	42.00 in	42.00 in	9.62	
PIPE 12-2	65.70	CIRCULAR	42.00 in	42.00 in	42.00 in	42.00 in	42.00 in	42.00 in	9.62	
PIPE 10	6.90	CIRCULAR	18.00 in	18.00 in	18.00 in	18.00 in	18.00 in	18.00 in	1.77	
PIPE 11	5.40	CIRCULAR	18.00 in	18.00 in	18.00 in	18.00 in	18.00 in	18.00 in	1.77	
PIPE 9-1	56.90	CIRCULAR	36.00 in	36.00 in	33.00 in	33.00 in	36.00 in	36.00 in	7.07	
PIPE 9-2	56.90	CIRCULAR	36.00 in	36.00 in	36.00 in	36.00 in	36.00 in	36.00 in	7.07	
PIPE 9-3	56.90	CIRCULAR	36.00 in	36.00 in	36.00 in	36.00 in	36.00 in	36.00 in	7.07	
PIPE 9-4	56.90	CIRCULAR	36.00 in	36.00 in	36.00 in	36.00 in	36.00 in	36.00 in	7.07	
PIPE 9-5	56.90	CIRCULAR	36.00 in	36.00 in	36.00 in	36.00 in	36.00 in	36.00 in	7.07	
PIPE 9-6	56.90	CIRCULAR	36.00 in	36.00 in	36.00 in	36.00 in	36.00 in	36.00 in	7.07	
PIPE 9-7	56.90	CIRCULAR	36.00 in	36.00 in	36.00 in	36.00 in	36.00 in	36.00 in	7.07	
PIPE 9-8	56.90	CIRCULAR	36.00 in	36.00 in	42.00 in	42.00 in	36.00 in	36.00 in	7.07	Existing height is smaller than the suggested height. Existing width is smaller than the suggested width. Exceeds max. Depth/Rise
PIPE 7	18.90	CIRCULAR	24.00 in	24.00 in	24.00 in	24.00 in	24.00 in	24.00 in	3.14	
PIPE 6B-1	30.90	CIRCULAR	30.00 in	30.00 in	33.00 in	33.00 in	30.00 in	30.00 in	4.91	Existing height is smaller than the suggested height.

											Existing width is smaller than the suggested width. Exceeds max. Depth/Rise
PIPE 6B-2	30.90	CIRCULAR	30.00 in	30.00 in	33.00 in	33.00 in	30.00 in	30.00 in	4.91		Existing height is smaller than the suggested height. Existing width is smaller than the suggested width. Exceeds max. Depth/Rise
PIPE 39-1	30.90	CIRCULAR	30.00 in	30.00 in	24.00 in	24.00 in	30.00 in	30.00 in	4.91		
PIPE 39-2	30.90	CIRCULAR	30.00 in	30.00 in	24.00 in	24.00 in	30.00 in	30.00 in	4.91		
PIPE 39-3	30.90	CIRCULAR	30.00 in	30.00 in	24.00 in	24.00 in	30.00 in	30.00 in	4.91		
PIPE 37	13.10	CIRCULAR	24.00 in	24.00 in	21.00 in	21.00 in	24.00 in	24.00 in	3.14		
PIPE 38	3.70	CIRCULAR	18.00 in	18.00 in	18.00 in	18.00 in	18.00 in	18.00 in	1.77		
PIPE 36-1	14.90	CIRCULAR	24.00 in	24.00 in	18.00 in	18.00 in	24.00 in	24.00 in	3.14		
PIPE 36-2	14.90	CIRCULAR	24.00 in	24.00 in	18.00 in	18.00 in	24.00 in	24.00 in	3.14		
PIPE 36-3	14.90	CIRCULAR	24.00 in	24.00 in	18.00 in	18.00 in	24.00 in	24.00 in	3.14		
PIPE 8	8.30	CIRCULAR	18.00 in	18.00 in	18.00 in	18.00 in	18.00 in	18.00 in	1.77		

- Calculated diameter was determined by sewer hydraulic capacity rounded up to the nearest commercially available size.
- Sewer sizes should not decrease downstream.
- All hydraulics were calculated using the 'Used' parameters.

## Grade Line Summary:

Tailwater Elevation (ft): 0.00



Element Name	Invert Elev.		Downstream Manhole Losses		HGL		EGL		
	Downstream (ft)	Upstream (ft)	Bend Loss (ft)	Lateral Loss (ft)	Downstream (ft)	Upstream (ft)	Downstream (ft)	Friction Loss (ft)	Upstream (ft)
PIPE 14	7055.59	7055.95	0.00	0.00	7059.09	7059.52	7060.10	0.43	7060.53
PIPE 13	7057.45	7059.19	0.40	0.00	7060.62	7060.62	7060.92	0.21	7061.13
PIPE 12-1	7056.15	7056.78	0.04	0.29	7060.12	7060.66	7060.85	0.53	7061.38
PIPE 12-2	7056.77	7057.09	0.39	0.46	7061.51	7061.78	7062.23	0.27	7062.50
PIPE 10	7059.10	7059.39	0.20	0.00	7062.46	7062.59	7062.70	0.13	7062.83
PIPE 11	7059.09	7059.69	0.06	0.00	7062.41	7062.43	7062.56	0.02	7062.57
PIPE 9-1	7057.59	7060.09	0.05	0.00	7061.83	7063.12	7062.84	1.29	7064.13
PIPE 9-2	7060.29	7060.97	0.10	0.27	7063.49	7063.86	7064.50	0.39	7064.89
PIPE 9-3	7060.97	7061.58	0.08	0.23	7064.19	7064.60	7065.20	0.40	7065.60
PIPE 9-4	7061.59	7062.13	0.08	0.23	7064.91	7065.27	7065.92	0.36	7066.27
PIPE 9-5	7062.33	7062.93	0.08	0.23	7065.58	7066.01	7066.59	0.43	7067.02
PIPE 9-6	7062.93	7063.39	0.08	0.23	7066.33	7066.66	7067.33	0.34	7067.67
PIPE 9-7	7063.39	7064.32	0.08	0.23	7066.97	7067.65	7067.98	0.67	7068.65
PIPE 9-8	7064.52	7064.90	0.91	0.72	7069.28	7069.82	7070.28	0.55	7070.83
PIPE 7	7065.90	7066.17	0.74	0.00	7071.01	7071.20	7071.57	0.19	7071.76
PIPE 6B-1	7065.39	7065.59	0.03	0.39	7070.63	7070.86	7071.25	0.22	7071.47
PIPE 6B-2	7065.59	7065.82	0.03	0.10	7070.99	7071.24	7071.60	0.26	7071.86
PIPE 39-1	7066.12	7067.36	0.03	0.10	7071.37	7071.68	7071.99	0.30	7072.29
PIPE 39-2	7067.35	7068.83	0.03	0.12	7071.82	7072.19	7072.44	0.36	7072.80
PIPE 39-3	7068.83	7072.05	0.03	0.10	7072.31	7073.94	7072.93	1.95	7074.88
PIPE 37	7072.55	7072.82	0.36	0.00	7074.96	7075.05	7075.23	0.09	7075.32

PIPE 38	7073.05	7073.42	0.09	0.00	7074.03	7075.75	7075.82	0.00	7075.82
PIPE 36-1	7072.56	7077.92	0.02	0.27	7074.23	7079.31	7076.75	3.19	7079.94
PIPE 36-2	7078.22	7095.09	0.02	0.00	7079.33	7096.48	7083.06	14.06	7097.11
PIPE 36-3	7095.40	7098.37	0.13	0.20	7096.81	7099.76	7100.24	0.15	7100.39
PIPE 8	7066.40	7066.69	0.45	0.00	7070.94	7070.96	7071.28	0.02	7071.30

- Bend and Lateral losses only apply when there is an outgoing sewer. The system outfall, sewer #0, is not considered a sewer.
- Bend loss = Bend K \* V<sub>fi</sub> ^ 2/(2\*g)
- Lateral loss = V<sub>fo</sub> ^ 2/(2\*g)- Junction Loss K \* V<sub>fi</sub> ^ 2/(2\*g).
- Friction loss is always Upstream EGL - Downstream EGL.

## Excavation Estimate:

The trench side slope is 1.0 ft/ft

The minimum trench width is 2.00 ft

Element Name	Length (ft)	Wall (in)	Bedding (in)	Bottom Width (ft)	Downstream			Upstream			Volume (cu. yd)	Comment
					Top Width (ft)	Trench Depth (ft)	Cover (ft)	Top Width (ft)	Trench Depth (ft)	Cover (ft)		
PIPE 14	72.62	4.50	6.00	7.25	0.00	0.88	0.00	17.10	10.68	5.93	145.26	Sewer Too Shallow
PIPE 13	17.38	3.00	4.00	5.50	15.60	8.88	6.05	11.52	6.84	4.01	38.95	
PIPE 12-1	125.04	4.50	6.00	7.25	16.69	10.47	5.72	19.02	11.64	6.89	502.88	
PIPE 12-2	63.60	4.50	6.00	7.25	19.04	11.64	6.89	20.68	12.47	7.72	299.86	
PIPE 10	29.31	2.50	4.00	4.92	18.67	10.12	7.87	18.76	10.17	7.92	105.82	

PIPE 11	5.96	2.50	4.00	4.92	18.68	10.13	7.88	18.16	9.87	7.62	20.93	
PIPE 9-1	178.52	4.00	6.00	6.67	20.18	11.92	7.76	20.58	12.12	7.96	840.84	
PIPE 9-2	61.53	4.00	6.00	6.67	20.17	11.92	7.75	20.56	12.11	7.95	289.52	
PIPE 9-3	55.87	4.00	6.00	6.67	20.57	12.12	7.95	20.86	12.26	8.10	270.27	
PIPE 9-4	49.39	4.00	6.00	6.67	20.85	12.26	8.09	21.32	12.49	8.33	245.99	
PIPE 9-5	59.96	4.00	6.00	6.67	20.92	12.29	8.13	21.36	12.51	8.35	299.95	
PIPE 9-6	46.32	4.00	6.00	6.67	21.37	12.52	8.35	21.74	12.70	8.54	239.28	
PIPE 9-7	92.93	4.00	6.00	6.67	21.74	12.70	8.54	22.58	13.12	8.96	502.98	
PIPE 9-8	75.46	4.00	6.00	6.67	22.17	12.92	8.75	20.28	11.97	7.81	380.67	
PIPE 7	27.37	3.00	4.00	5.50	19.29	10.73	7.89	19.34	10.75	7.92	108.24	
PIPE 6B-1	39.51	3.50	6.00	6.08	19.80	11.44	7.86	19.86	11.47	7.89	171.08	
PIPE 6B-2	45.39	3.50	6.00	6.08	19.85	11.47	7.89	20.62	11.85	8.27	203.50	
PIPE 39-1	53.80	3.50	6.00	6.08	20.01	11.55	7.97	20.20	11.64	8.06	238.53	
PIPE 39-2	64.14	3.50	6.00	6.08	20.21	11.65	8.06	19.76	11.42	7.84	281.49	
PIPE 39-3	139.94	3.50	6.00	6.08	19.76	11.42	7.84	20.24	11.66	8.08	614.86	
PIPE 37	26.71	3.00	4.00	5.50	19.73	10.95	8.12	19.56	10.86	8.03	108.84	
PIPE 38	3.63	2.50	4.00	4.92	19.24	10.41	8.16	18.86	10.22	7.97	13.53	
PIPE 36-1	89.40	3.00	4.00	5.50	19.73	10.95	8.11	19.00	10.58	7.75	355.27	
PIPE 36-2	219.12	3.00	4.00	5.50	18.40	10.29	7.45	19.48	10.82	7.99	838.30	
PIPE 36-3	38.56	3.00	4.00	5.50	18.86	10.51	7.68	18.26	10.21	7.38	142.32	
PIPE 8	2.97	2.50	4.00	4.92	18.78	10.18	7.93	18.80	10.19	7.94	10.80	

**Total earth volume for sewer trenches = 7270 cubic yards.**

- The trench was estimated to have a bottom width equal to the outer pipe diameter plus 36 inches.

- If the calculated width of the trench bottom is less than the minimum acceptable width, the minimum acceptable width was used.
- The sewer wall thickness is equal to:  $(\text{equivalent diameter in inches}/12)+1$  inches
- The sewer bedding thickness is equal to:
  - Four inches for pipes less than 33 inches.
  - Six inches for pipes less than 60 inches.
  - Eight inches for all larger sizes.

## **System Input Summary**

## **POND A OUTFALL PIPE – 100 YR**

### **Rainfall Parameters**

**Rainfall Return Period:** 100

**Rainfall Calculation Method:** Formula

**One Hour Depth (in):**

**Rainfall Constant "A":** 28.5

**Rainfall Constant "B":** 10

**Rainfall Constant "C":** 0.786

### **Rational Method Constraints**

**Minimum Urban Runoff Coeff.:** 0.20

**Maximum Rural Overland Len. (ft):** 500

**Maximum Urban Overland Len. (ft):** 300

**Used UDFCD Tc. Maximum:** Yes

### **Sizer Constraints**

**Minimum Sewer Size (in):** 18.00

**Maximum Depth to Rise Ratio:** 0.90

**Maximum Flow Velocity (fps):** 18.0

**Minimum Flow Velocity (fps):** 2.0

### **Backwater Calculations:**

**Tailwater Elevation (ft):** 0.00

## Manhole Input Summary:

		Given Flow		Sub Basin Information						
Element Name	Ground Elevation (ft)	Total Known Flow (cfs)	Local Contribution (cfs)	Drainage Area (Ac.)	Runoff Coefficient	5yr Coefficient	Overland Length (ft)	Overland Slope (%)	Gutter Length (ft)	Gutter Velocity (fps)
OUTFALL 1	7105.73	0.00	0.00	0.00	0.00	0.00	0.00	0.00	0.00	0.00
PIPE 26	7114.40	48.50	0.00	0.00	0.00	0.00	0.00	0.00	0.00	0.00

## Manhole Output Summary:

		Local Contribution				Total Design Flow				
Element Name	Overland Time (min)	Gutter Time (min)	Basin Tc (min)	Intensity (in/hr)	Local Contrib (cfs)	Coeff. Area	Intensity (in/hr)	Manhole Tc (min)	Peak Flow (cfs)	Comment
OUTFALL 1	0.00	0.00	0.00	0.00	0.00	0.00	0.00	0.00	0.00	
PIPE 26	0.00	0.00	0.00	0.00	0.00	0.00	0.00	0.00	48.50	Surface Water Present (Downstream)

## Sewer Input Summary:

	Elevation	Loss Coefficients	Given Dimensions
--	-----------	-------------------	------------------



- Calculated diameter was determined by sewer hydraulic capacity rounded up to the nearest commercially available size.
- Sewer sizes should not decrease downstream.
- All hydraulics were calculated using the 'Used' parameters.

## Grade Line Summary:

**Tailwater Elevation (ft): 0.00**

Element Name	Invert Elev.		Downstream Manhole Losses		HGL		EGL		
	Downstream (ft)	Upstream (ft)	Bend Loss (ft)	Lateral Loss (ft)	Downstream (ft)	Upstream (ft)	Downstream (ft)	Friction Loss (ft)	Upstream (ft)
PIPE 26	7106.72	7107.80	0.00	0.00	7108.58	7110.08	7110.95	0.78	7111.74

- Bend and Lateral losses only apply when there is an outgoing sewer. The system outfall, sewer #0, is not considered a sewer.
- Bend loss = Bend K \* V<sub>fi</sub> ^ 2 / (2 \* g)
- Lateral loss = V<sub>fo</sub> ^ 2 / (2 \* g) - Junction Loss K \* V<sub>fi</sub> ^ 2 / (2 \* g).
- Friction loss is always Upstream EGL - Downstream EGL.

## Excavation Estimate:

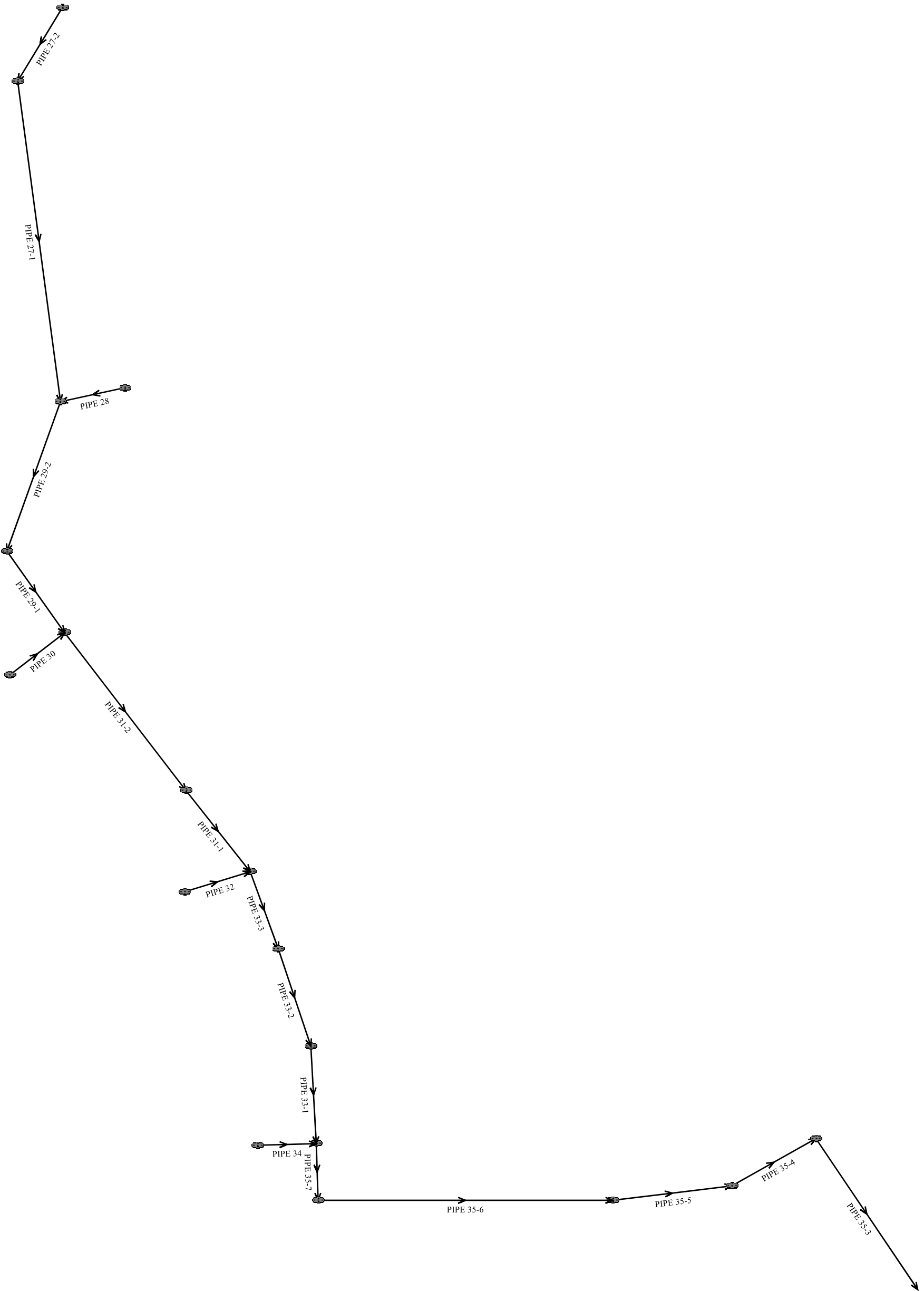


The trench side slope is 1.0 ft/ft  
 The minimum trench width is 2.00 ft

Element Name	Length (ft)	Wall (in)	Bedding (in)	Bottom Width (ft)	Downstream			Upstream			Volume (cu. yd)	Comment
					Top Width (ft)	Trench Depth (ft)	Cover (ft)	Top Width (ft)	Trench Depth (ft)	Cover (ft)		
PIPE 26	63.81	3.50	6.00	6.08	0.00	0.00	0.00	11.70	7.39	3.81	62.45	Sewer Too Shallow

**Total earth volume for sewer trenches = 62 cubic yards.**

- The trench was estimated to have a bottom width equal to the outer pipe diameter plus 36 inches.
- If the calculated width of the trench bottom is less than the minimum acceptable width, the minimum acceptable width was used.
- The sewer wall thickness is equal to: (equivalent diameter in inches/12)+1 inches
- The sewer bedding thickness is equal to:
  - Four inches for pipes less than 33 inches.
  - Six inches for pipes less than 60 inches.
  - Eight inches for all larger sizes.



## **System Input Summary**

## **BYPASS SYSTEM – 100-YR HGL CALCS**

### **Rainfall Parameters**

**Rainfall Return Period:** 100

**Rainfall Calculation Method:** Formula

**One Hour Depth (in):**

**Rainfall Constant "A":** 28.5

**Rainfall Constant "B":** 10

**Rainfall Constant "C":** 0.786

### **Rational Method Constraints**

**Minimum Urban Runoff Coeff.:** 0.20

**Maximum Rural Overland Len. (ft):** 500

**Maximum Urban Overland Len. (ft):** 300

**Used UDFCD Tc. Maximum:** Yes

### **Sizer Constraints**

**Minimum Sewer Size (in):** 18.00

**Maximum Depth to Rise Ratio:** 0.90

**Maximum Flow Velocity (fps):** 18.0

**Minimum Flow Velocity (fps):** 2.0

### **Backwater Calculations:**

**Tailwater Elevation (ft):** 0.00



PIPE 32	7204.50	16.60	0.00	0.00	0.00	0.00	0.00	0.00	0.00	0.00
---------	---------	-------	------	------	------	------	------	------	------	------

## Manhole Output Summary:

Element Name	Local Contribution					Total Design Flow				Comment
	Overland Time (min)	Gutter Time (min)	Basin Tc (min)	Intensity (in/hr)	Local Contrib (cfs)	Coeff. Area	Intensity (in/hr)	Manhole Tc (min)	Peak Flow (cfs)	
OUTFALL 1	0.00	0.00	0.00	0.00	0.00	0.00	0.00	0.00	0.00	
PIPE 35-3	0.00	0.00	0.00	0.00	0.00	0.00	0.00	0.00	172.40	Surface Water Present (Downstream)
PIPE 35-4	0.00	0.00	0.00	0.00	0.00	0.00	0.00	0.00	172.40	
PIPE 35-5	0.00	0.00	0.00	0.00	0.00	0.00	0.00	0.00	172.40	
PIPE 35-6	0.00	0.00	0.00	0.00	0.00	0.00	0.00	0.00	172.40	
PIPE 35-7	0.00	0.00	0.00	0.00	0.00	0.00	0.00	0.00	172.40	
PIPE 34	0.00	0.00	0.00	0.00	0.00	0.00	0.00	0.00	14.10	
PIPE 33-1	0.00	0.00	0.00	0.00	0.00	0.00	0.00	0.00	162.30	
PIPE 33-2	0.00	0.00	0.00	0.00	0.00	0.00	0.00	0.00	162.30	
PIPE 33-3	0.00	0.00	0.00	0.00	0.00	0.00	0.00	0.00	162.30	
PIPE 31-1	0.00	0.00	0.00	0.00	0.00	0.00	0.00	0.00	148.00	
PIPE 31-2	0.00	0.00	0.00	0.00	0.00	0.00	0.00	0.00	148.00	
PIPE 30	0.00	0.00	0.00	0.00	0.00	0.00	0.00	0.00	36.50	
PIPE 29-1	0.00	0.00	0.00	0.00	0.00	0.00	0.00	0.00	112.40	
PIPE 29-2	0.00	0.00	0.00	0.00	0.00	0.00	0.00	0.00	112.40	

PIPE 27-1	0.00	0.00	0.00	0.00	0.00	0.00	0.00	0.00	51.90	
PIPE 27-2	0.00	0.00	0.00	0.00	0.00	0.00	0.00	0.00	51.90	
PIPE 28	0.00	0.00	0.00	0.00	0.00	0.00	0.00	0.00	60.60	
PIPE 32	0.00	0.00	0.00	0.00	0.00	0.00	0.00	0.00	16.60	

## Sewer Input Summary:

Element Name	Sewer Length (ft)	Elevation			Loss Coefficients			Given Dimensions		
		Downstream Invert (ft)	Slope (%)	Upstream Invert (ft)	Mannings n	Bend Loss	Lateral Loss	Cross Section	Rise (ft or in)	Span (ft or in)
PIPE 35-3	186.71	7120.75	1.9	7124.30	0.013	0.03	1.00	CIRCULAR	48.00 in	48.00 in
PIPE 35-4	66.85	7128.96	1.9	7130.23	0.013	1.21	0.25	CIRCULAR	48.00 in	48.00 in
PIPE 35-5	66.85	7128.96	1.9	7130.23	0.013	0.06	0.81	CIRCULAR	48.00 in	48.00 in
PIPE 35-6	369.55	7132.26	4.0	7147.04	0.013	0.07	0.77	CIRCULAR	48.00 in	48.00 in
PIPE 35-7	52.92	7149.58	4.0	7151.70	0.013	1.32	0.25	CIRCULAR	48.00 in	48.00 in
PIPE 34	14.62	7158.19	10.1	7159.67	0.013	1.32	0.00	CIRCULAR	24.00 in	24.00 in
PIPE 33-1	129.69	7156.70	4.0	7161.89	0.013	0.05	1.00	CIRCULAR	42.00 in	42.00 in
PIPE 33-2	235.38	7165.89	4.0	7175.31	0.013	0.05	0.87	CIRCULAR	42.00 in	42.00 in
PIPE 33-3	73.31	7180.31	4.0	7183.24	0.013	0.05	1.00	CIRCULAR	42.00 in	42.00 in
PIPE 31-1	46.86	7190.24	4.4	7192.30	0.013	0.05	0.84	CIRCULAR	42.00 in	42.00 in
PIPE 31-2	256.34	7197.30	4.4	7208.58	0.013	0.05	1.00	CIRCULAR	42.00 in	42.00 in
PIPE 30	43.29	7215.08	5.0	7217.24	0.013	1.32	0.00	CIRCULAR	30.00 in	30.00 in
PIPE 29-1	87.99	7214.58	4.4	7218.45	0.013	0.05	1.00	CIRCULAR	36.00 in	36.00 in
PIPE 29-2	223.31	7226.80	4.3	7236.40	0.013	0.38	0.44	CIRCULAR	36.00 in	36.00 in

PIPE 27-1	347.52	7236.95	4.8	7253.63	0.013	0.15	0.64	CIRCULAR	30.00 in	30.00 in
PIPE 27-2	38.77	7253.93	2.0	7254.71	0.013	0.38	0.44	CIRCULAR	30.00 in	30.00 in
PIPE 28	17.09	7236.90	2.0	7237.24	0.013	0.38	0.00	CIRCULAR	30.00 in	30.00 in
PIPE 32	30.42	7191.74	9.0	7194.48	0.013	1.32	0.00	CIRCULAR	24.00 in	24.00 in

## Sewer Flow Summary:

Element Name	Full Flow Capacity		Critical Flow		Normal Flow				Flow (cfs)	Surcharged Length (ft)	Comment
	Flow (cfs)	Velocity (fps)	Depth (in)	Velocity (fps)	Depth (in)	Velocity (fps)	Froude Number	Flow Condition			
PIPE 35-3	198.60	15.80	44.87	14.11	34.56	17.80	1.91	Supercritical	172.40	0.00	
PIPE 35-4	198.52	15.80	44.87	14.11	34.57	17.79	1.91	Pressurized	172.40	66.85	
PIPE 35-5	198.52	15.80	44.87	14.11	34.57	17.79	1.91	Pressurized	172.40	66.85	
PIPE 35-6	288.06	22.92	44.87	14.11	26.76	23.95	3.13	Supercritical Jump	172.40	46.80	Velocity is Too High
PIPE 35-7	288.06	22.92	44.87	14.11	26.76	23.95	3.13	Pressurized	172.40	52.92	Velocity is Too High
PIPE 34	72.09	22.95	16.23	6.24	7.20	17.80	4.77	Supercritical	14.10	0.00	
PIPE 33-1	201.76	20.97	41.00	16.97	28.53	23.32	2.82	Supercritical	162.30	0.00	Velocity is Too High
PIPE 33-2	201.76	20.97	41.00	16.97	28.53	23.32	2.82	Supercritical	162.30	0.00	Velocity is Too High
PIPE 33-3	201.76	20.97	41.00	16.97	28.53	23.32	2.82	Supercritical	162.30	0.00	Velocity is Too High
PIPE 31-1	211.61	21.99	40.57	15.55	25.88	23.79	3.10	Supercritical	148.00	0.00	Velocity is Too High
PIPE 31-2	211.61	21.99	40.57	15.55	25.88	23.79	3.10	Supercritical	148.00	0.00	Velocity is Too High
PIPE 30	91.96	18.73	24.57	8.48	13.14	17.66	3.41	Supercritical	36.50	0.00	
PIPE 29-1	140.28	19.85	35.20	15.99	24.38	22.06	2.88	Supercritical	112.40	0.00	Velocity is Too High





PIPE 33-3	162.30	CIRCULAR	42.00 in	42.00 in	42.00 in	42.00 in	42.00 in	42.00 in	9.62	
PIPE 31-1	148.00	CIRCULAR	42.00 in	42.00 in	42.00 in	42.00 in	42.00 in	42.00 in	9.62	
PIPE 31-2	148.00	CIRCULAR	42.00 in	42.00 in	42.00 in	42.00 in	42.00 in	42.00 in	9.62	
PIPE 30	36.50	CIRCULAR	30.00 in	30.00 in	24.00 in	24.00 in	30.00 in	30.00 in	4.91	
PIPE 29-1	112.40	CIRCULAR	36.00 in	36.00 in	36.00 in	36.00 in	36.00 in	36.00 in	7.07	
PIPE 29-2	112.40	CIRCULAR	36.00 in	36.00 in	36.00 in	36.00 in	36.00 in	36.00 in	7.07	
PIPE 27-1	51.90	CIRCULAR	30.00 in	30.00 in	27.00 in	27.00 in	30.00 in	30.00 in	4.91	
PIPE 27-2	51.90	CIRCULAR	30.00 in	30.00 in	30.00 in	30.00 in	30.00 in	30.00 in	4.91	
PIPE 28	60.60	CIRCULAR	30.00 in	30.00 in	33.00 in	33.00 in	30.00 in	30.00 in	4.91	Existing height is smaller than the suggested height. Existing width is smaller than the suggested width. Exceeds max. Depth/Rise
PIPE 32	16.60	CIRCULAR	24.00 in	24.00 in	18.00 in	18.00 in	24.00 in	24.00 in	3.14	

- Calculated diameter was determined by sewer hydraulic capacity rounded up to the nearest commercially available size.
- Sewer sizes should not decrease downstream.
- All hydraulics were calculated using the 'Used' parameters.

## Grade Line Summary:

Tailwater Elevation (ft): 0.00

	Invert Elev.	Downstream Manhole Losses	HGL	EGL
--	--------------	---------------------------	-----	-----

Element Name	Downstream (ft)	Upstream (ft)	Bend Loss (ft)	Lateral Loss (ft)	Downstream (ft)	Upstream (ft)	Downstream (ft)	Friction Loss (ft)	Upstream (ft)
PIPE 35-3	7120.75	7124.30	0.00	0.00	7123.63	7128.04	7128.55	2.58	7131.13
PIPE 35-4	7128.96	7130.23	3.54	2.19	7133.94	7134.89	7136.86	0.96	7137.82
PIPE 35-5	7128.96	7130.23	0.18	0.56	7135.62	7136.58	7138.55	0.96	7139.51
PIPE 35-6	7132.26	7147.04	0.20	0.67	7137.46	7150.78	7140.38	13.49	7153.87
PIPE 35-7	7149.58	7151.70	3.86	2.19	7157.00	7157.76	7159.92	0.76	7160.68
PIPE 34	7158.19	7159.67	0.41	0.00	7158.79	7163.40	7163.71	0.00	7163.71
PIPE 33-1	7156.70	7161.89	0.22	0.00	7159.08	7165.31	7167.53	2.26	7169.78
PIPE 33-2	7165.89	7175.31	0.22	0.57	7168.27	7178.73	7176.72	6.48	7183.20
PIPE 33-3	7180.31	7183.24	0.22	0.00	7182.69	7186.66	7191.13	0.00	7191.13
PIPE 31-1	7190.24	7192.30	0.18	1.33	7192.90	7195.68	7198.41	1.02	7199.43
PIPE 31-2	7197.30	7208.58	0.18	0.00	7199.46	7211.96	7208.25	7.47	7215.71
PIPE 30	7215.08	7217.24	1.13	0.00	7216.17	7220.15	7221.01	0.00	7221.01
PIPE 29-1	7214.58	7218.45	0.20	0.00	7216.61	7221.38	7224.16	1.19	7225.35
PIPE 29-2	7226.80	7236.40	1.49	2.20	7228.85	7239.33	7236.26	7.04	7243.30
PIPE 27-1	7236.95	7253.63	0.26	2.82	7244.64	7255.95	7246.38	11.42	7257.80
PIPE 27-2	7253.93	7254.71	0.66	0.97	7257.70	7258.32	7259.43	0.62	7260.05
PIPE 28	7236.90	7237.24	0.90	0.00	7241.84	7242.21	7244.20	0.37	7244.57
PIPE 32	7191.74	7194.48	0.57	0.00	7192.41	7196.95	7197.38	0.00	7197.38

- Bend and Lateral losses only apply when there is an outgoing sewer. The system outfall, sewer #0, is not considered a sewer.
- Bend loss = Bend K \* V<sub>fi</sub> ^ 2/(2\*g)
- Lateral loss = V<sub>fo</sub> ^ 2/(2\*g)- Junction Loss K \* V<sub>fi</sub> ^ 2/(2\*g).

- Friction loss is always Upstream EGL - Downstream EGL.

## Excavation Estimate:

The trench side slope is 1.0 ft/ft

The minimum trench width is 2.00 ft

Element Name	Length (ft)	Wall (in)	Bedding (in)	Bottom Width (ft)	Downstream			Upstream			Volume (cu. yd)	Comment
					Top Width (ft)	Trench Depth (ft)	Cover (ft)	Top Width (ft)	Trench Depth (ft)	Cover (ft)		
PIPE 35-3	186.71	5.00	6.00	7.83	0.00	0.00	0.00	31.46	18.15	12.81	974.02	Sewer Too Shallow
PIPE 35-4	66.85	5.00	6.00	7.83	22.14	13.49	8.15	20.94	12.89	7.55	372.27	
PIPE 35-5	66.85	5.00	6.00	7.83	23.48	14.16	8.82	23.98	14.41	9.07	433.45	
PIPE 35-6	369.55	5.00	6.00	7.83	19.92	12.38	7.05	30.30	17.57	12.23	2718.97	
PIPE 35-7	52.92	5.00	6.00	7.83	25.21	15.02	9.69	27.12	15.98	10.64	403.12	
PIPE 34	14.62	3.00	4.00	5.50	16.13	9.15	6.32	11.16	6.66	3.83	33.37	
PIPE 33-1	129.69	4.50	6.00	7.25	17.62	10.93	6.18	23.04	13.65	8.90	642.15	
PIPE 33-2	235.38	4.50	6.00	7.25	15.03	9.64	4.89	28.66	16.46	11.71	1390.14	
PIPE 33-3	73.31	4.50	6.00	7.25	18.66	11.46	6.71	32.56	18.41	13.66	555.56	
PIPE 31-1	46.86	4.50	6.00	7.25	18.56	11.41	6.66	29.92	17.09	12.34	318.52	
PIPE 31-2	256.34	4.50	6.00	7.25	19.92	12.08	7.33	31.02	17.64	12.89	1883.79	
PIPE 30	43.29	3.50	6.00	6.08	19.03	11.06	7.47	28.02	15.55	11.97	259.79	
PIPE 29-1	87.99	4.00	6.00	6.67	19.52	11.59	7.43	38.72	21.19	17.03	842.04	
PIPE 29-2	223.31	4.00	6.00	6.67	22.02	12.85	8.68	20.86	12.26	8.10	1144.35	

PIPE 27-1	347.52	3.50	6.00	6.08	20.26	11.67	8.09	23.28	13.18	9.60	1772.26	
PIPE 27-2	38.77	3.50	6.00	6.08	22.67	12.88	9.29	9.08	6.08	2.50	133.80	
PIPE 28	17.09	3.50	6.00	6.08	20.36	11.72	8.14	8.92	6.00	2.42	50.90	
PIPE 32	30.42	3.00	4.00	5.50	17.06	9.61	6.78	19.04	10.60	7.77	107.26	

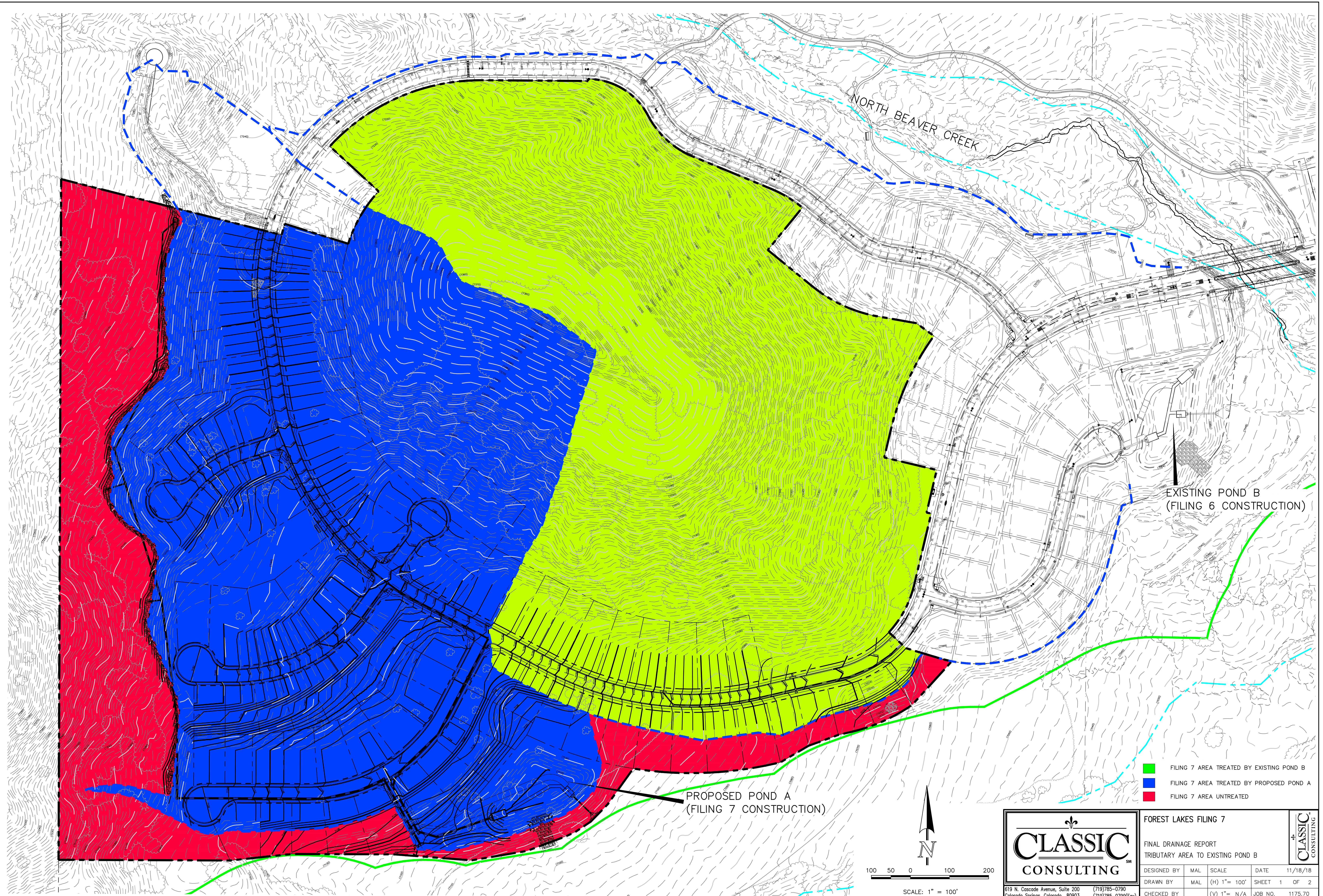
**Total earth volume for sewer trenches = 14036 cubic yards.**

- The trench was estimated to have a bottom width equal to the outer pipe diameter plus 36 inches.
- If the calculated width of the trench bottom is less than the minimum acceptable width, the minimum acceptable width was used.
- The sewer wall thickness is equal to:  $(\text{equivalent diameter in inches}/12)+1$  inches
- The sewer bedding thickness is equal to:
  - Four inches for pipes less than 33 inches.
  - Six inches for pipes less than 60 inches.
  - Eight inches for all larger sizes.

## **DRAINAGE MAPS**



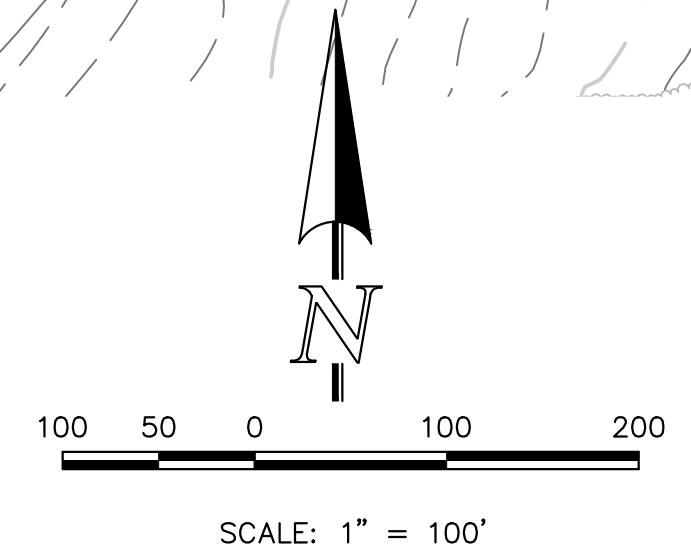
N:\175\DRAWINGS\DEVELOPMENT\BOUNDARY-FIBR EXHIBIT.dwg - 2/3/2022 3:17:04 PM - 1:1



EXISTING POND B  
(FILING 6 CONSTRUCTION)

PROPOSED POND A  
(FILING 7 CONSTRUCTION)

- FILING 7 AREA TREATED BY EXISTING POND B
- FILING 7 AREA TREATED BY PROPOSED POND A
- FILING 7 AREA UNTREATED



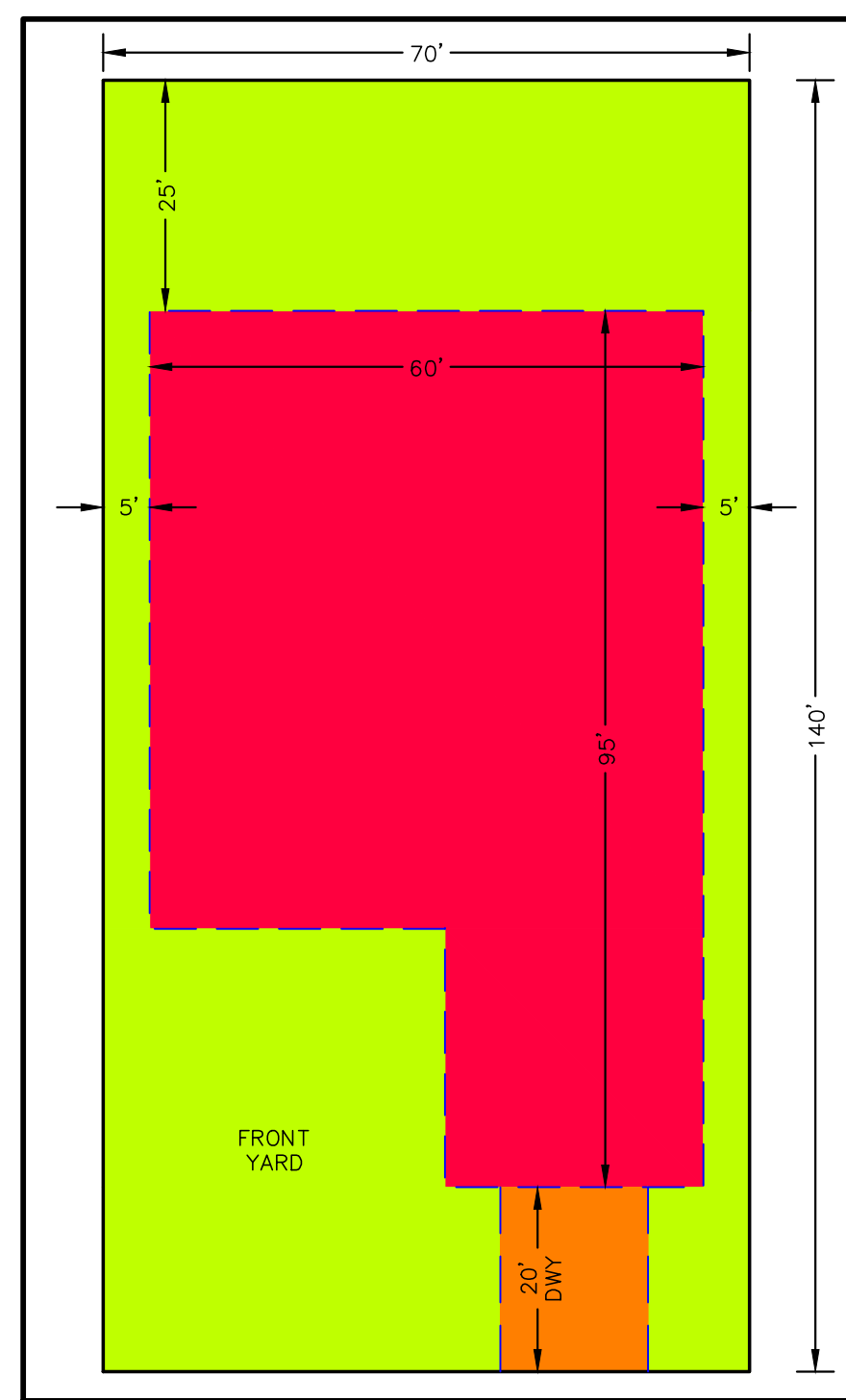
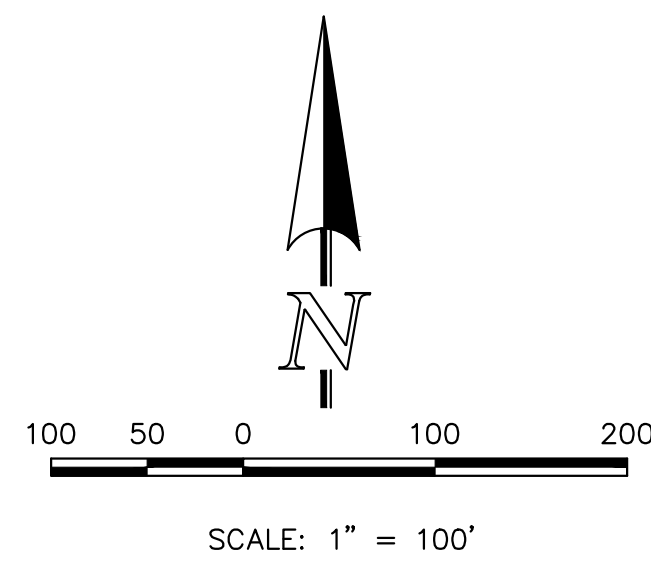
**CLASSIC**  
CONSULTING

619 N. Cascade Avenue, Suite 200  
Colorado Springs, Colorado 80903

(719) 785-0790  
(719) 785-0799 (Fax)

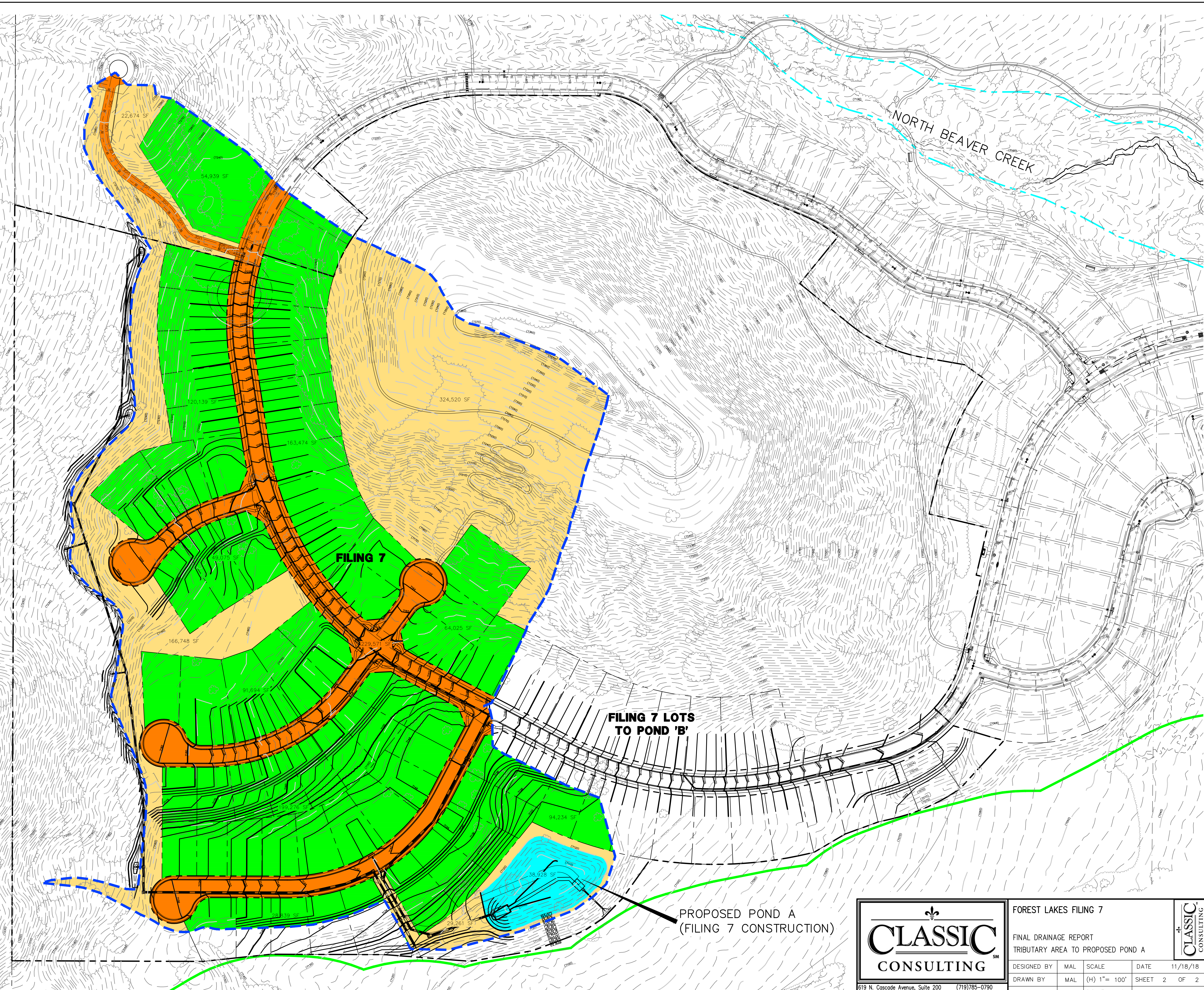
<b>FOREST LAKES FILING 7</b>			
FINAL DRAINAGE REPORT TRIBUTARY AREA TO EXISTING POND B			
DESIGNED BY	MAL	SCALE	DATE
DRAWN BY	MAL	(H) 1" = 100'	SHEET 1 OF 2
CHECKED BY	(V) 1" = N/A	JOB NO.	1175.70
			11/18/18

CLASSIC CONSULTING



**TYPICAL HOME LOT**  
 UIA = 55% OF LOT AREA  
 DCIA = 0.72% OF LOT AREA  
 RPA = 44.28% OF LOT AREA

- HOME LOTS (SEE BREAKDOWN ABOVE)
- SPA - SEPARATE PERVIOUS AREA
- UIA - UNCONNECTED IMPERVIOUS AREA
- DCIA - DIRECTLY CONNECTED IMPERVIOUS AREA
- RPA - RECEIVING PERVIOUS AREA



**FILING 7 LOTS TO POND 'B'**

**PROPOSED POND A  
(FILING 7 CONSTRUCTION)**

**CLASSIC CONSULTING**

619 N. Cascade Avenue, Suite 200  
 Colorado Springs, Colorado 80903

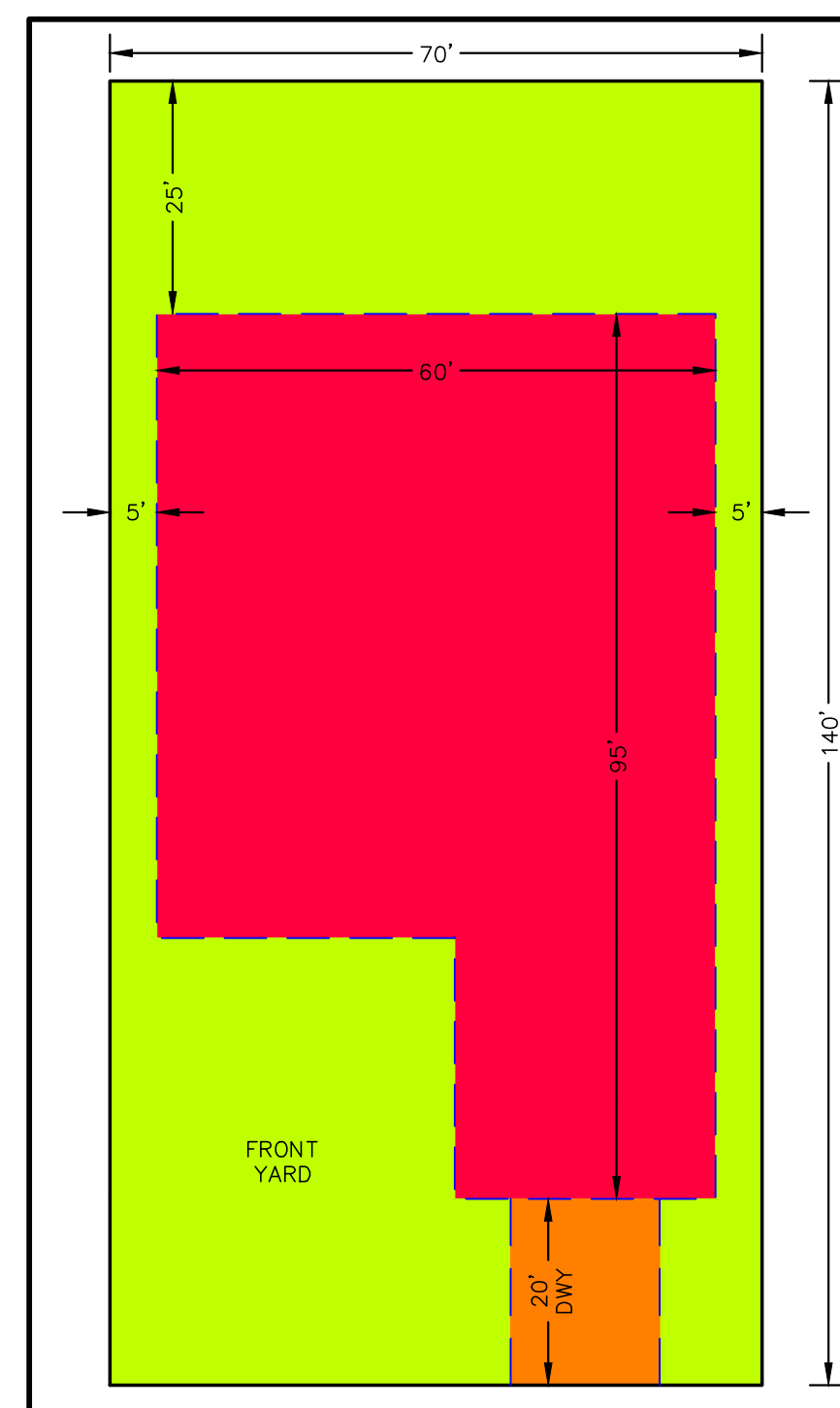
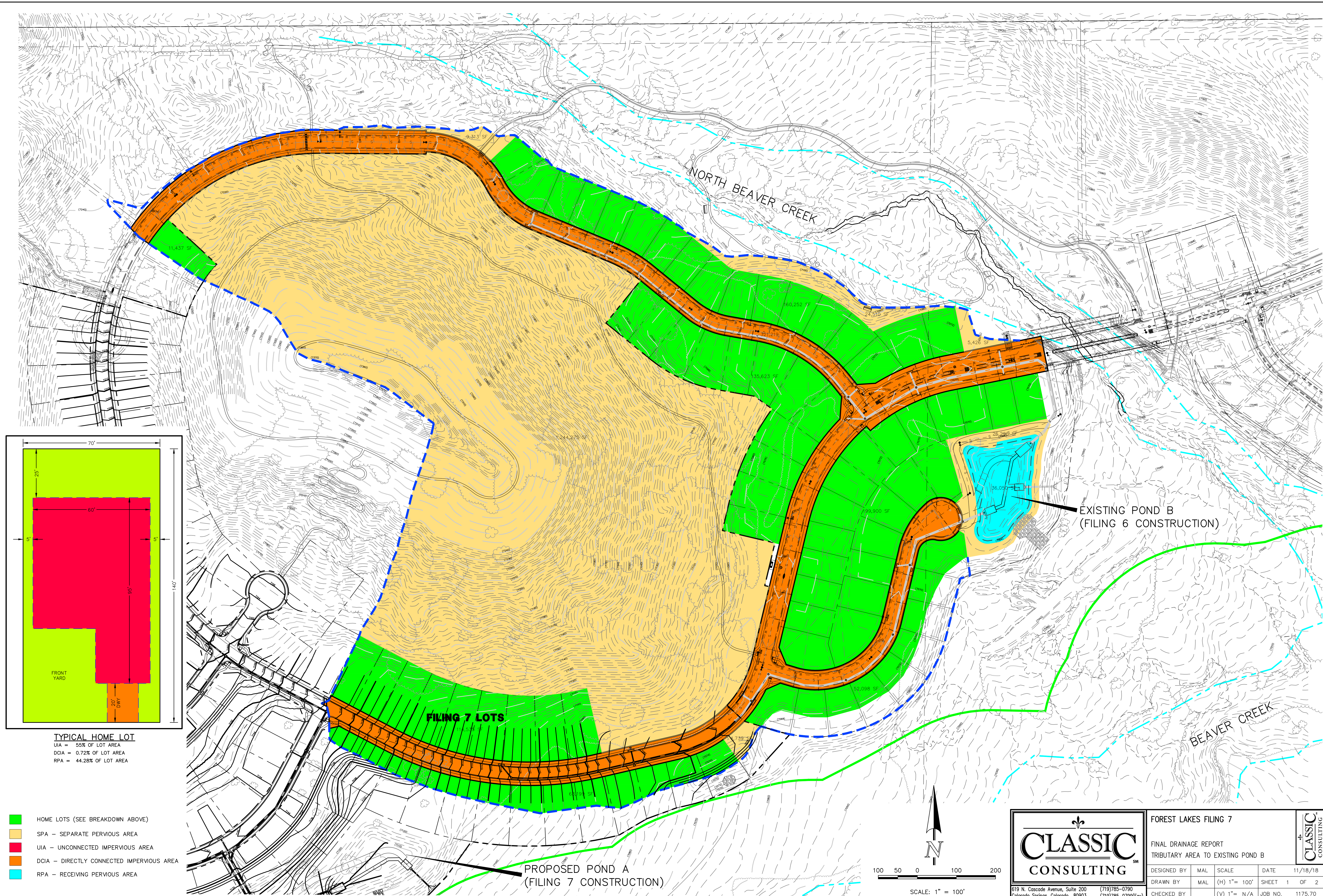
(719)785-0790  
 (719)785-0799(Fax)

**FOREST LAKES FILING 7**

FINAL DRAINAGE REPORT  
 TRIBUTARY AREA TO PROPOSED POND A

DESIGNED BY	MAL	SCALE	DATE	11/18/18
DRAWN BY	MAL	(H) 1" = 100'	SHEET	2 OF 2
CHECKED BY	(V)	1" = N/A	JOB NO.	1175.70

K:\1175\DRAWINGS\DEVELOPMENT\FILING AREA EXHIBIT - POND A.dwg, 11/17/2018 9:32:13 AM, 1:1

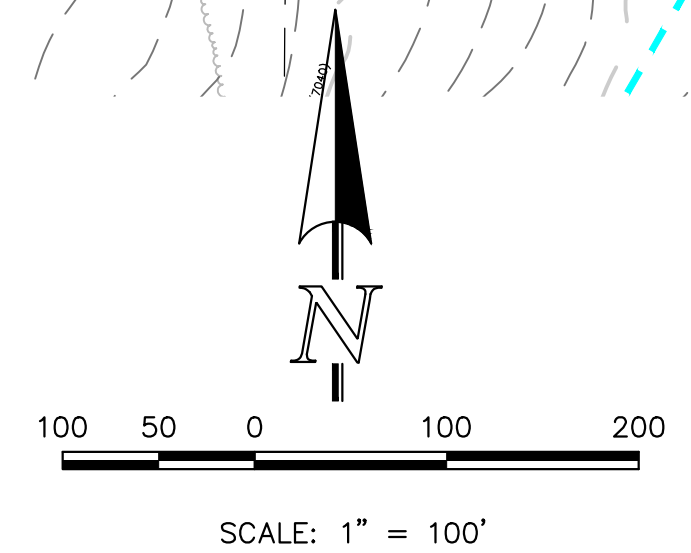


**TYPICAL HOME LOT**  
 UIA = 55% OF LOT AREA  
 DCIA = 0.72% OF LOT AREA  
 RPA = 44.28% OF LOT AREA

- HOME LOTS (SEE BREAKDOWN ABOVE)
- SPA - SEPARATE PERVIOUS AREA
- UIA - UNCONNECTED IMPERVIOUS AREA
- DCIA - DIRECTLY CONNECTED IMPERVIOUS AREA
- RPA - RECEIVING PERVIOUS AREA

PROPOSED POND A  
(FILING 7 CONSTRUCTION)

EXISTING POND B  
(FILING 6 CONSTRUCTION)



**CLASSIC CONSULTING**  
SM

619 N. Cascade Avenue, Suite 200  
 Colorado Springs, Colorado 80903  
 (719) 785-0790  
 (719) 785-0799 (Fax)

<b>FOREST LAKES FILING 7</b>			
FINAL DRAINAGE REPORT TRIBUTARY AREA TO EXISTING POND B			
DESIGNED BY	MAL	SCALE	DATE
DRAWN BY	MAL	(H) 1" = 100'	SHEET 1 OF 2
CHECKED BY	(V) 1" = N/A	JOB NO.	1175.70
			11/18/18



K:\1175\DRAWINGS\REVISED\TRIB AREA EXHIBIT - POND B.dwg, 11/17/2021 9:53:20 AM, 1:1





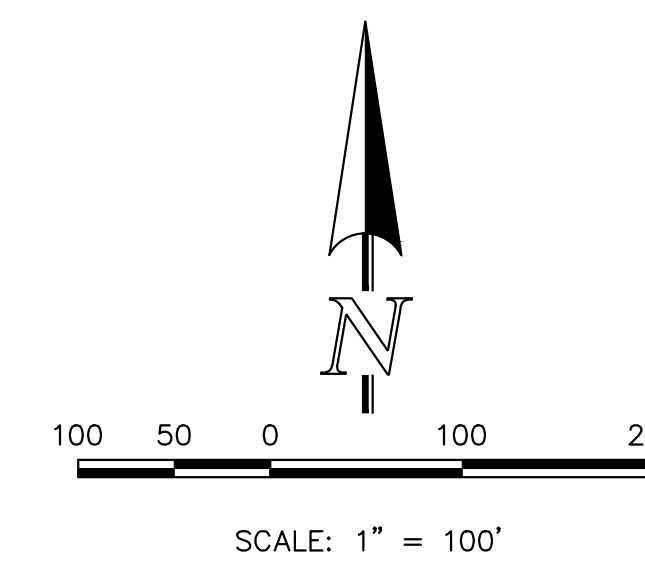
Q100 = 3,123 CFS  
FROM M.D.D.P.

40 ACRE LOT  
OWNER: TIMOTHY R.  
PETERSON TRUST

40 ACRE LOT  
OWNER: TIMOTHY R.  
PETERSON TRUST

NOTE:  
SEE FINAL DRAINAGE REPORT FOR  
FOREST LAKES FILING NO. 6 FOR  
EXISTING CONDITIONS BASINS AND  
DOWNSTREAM DRAINAGE PATTERNS

NOTE:  
SEE FINAL DRAINAGE REPORT FOR  
FOREST LAKES FILING NO. 6 FOR  
EXISTING CONDITIONS BASINS AND  
DOWNSTREAM DRAINAGE PATTERNS



**LEGEND**

- EXISTING GROUND CONTOUR (7000)
- SUBDIVISION BOUNDARY
- PREBLE'S MOUSE LIMITS
- 100-YR FLOODPLAIN LIMITS
- EXISTING BASIN BOUNDARY
- DIRECTION OF DRAINAGE
- EXISTING STORM SEWER
- EXISTING STORM INLET
- BASIN IDENTIFIER
- AREA IN ACRES
- DESIGN POINT
- EXISTING WETLANDS

**DESIGN POINT SUMMARY (RATIONAL METHOD)**

DESIGN POINT	Q5 (CFS)	Q100 (CFS)	FEATURE
1	5.6	15.2	(FILING 6) TEMP. CUL-DE-SAC
2	23.1	155.4	SURFACE (OFF-SITE)
3	0.4	2.8	SURFACE (OFF-SITE)
4	44.3	280.0	SURFACE (TO BEAVER CREEK)
5	13.8	92.4	(FILING 6 POND) TO BEAVER CREEK

**BASIN RUNOFF (RATIONAL)**

BASIN	ACREAGE	Q5 (CFS)	Q100 (CFS)
OS-1	66.39	23.1	155.4
EX-A	3.98	5.6	15.2
EX-B	60.79	18.1	121.8
EX-C	44.59	13.8	92.4
EX-D	1.00	0.4	2.8

**STORM SEWER FACILITIES:**  
ALL EXISTING AND PROPOSED STORM SEWER IS REINFORCED CONCRETE PIPE (RCP).  
ALL INLETS ARE CDOT TYPE R CURB INLETS AND CDOT TYPE C & D GRATED INLETS.  
STORM MANHOLES ARE TYPE I AND TYPE II PER COUNTY DDM STANDARDS.  
ALL MAINS AND INLETS COLLECTING WATER FROM PUBLIC R.O.W. WILL BE "PUBLIC".  
ALL STORM SEWER OUTSIDE OF THE R.O.W., INCLUDING THE POND OUTFALL PIPE IS "PRIVATE".  
THE EXISTING AND PROPOSED FULL SPECTRUM DETENTION FACILITIES ARE "PRIVATE".  
PRIVATE FACILITIES ARE OWNED AND MAINTAINED BY THE FOREST LAKES METROPOLITAN DISTRICT.



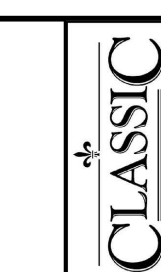
FOREST LAKES FILING NO. 7

EXISTING CONDITIONS DRAINAGE MAP

DESIGNED BY	MAL	SCALE	DATE
DRAWN BY	MAL	(H) 1" = 100'	02/23/21
CHECKED BY	(V) 1" = N/A		SHEET 2 OF 2
			JOB NO. 1175.70

619 N. Cascade Avenue, Suite 200  
Colorado Springs, Colorado 80903

(719) 785-0790  
(719) 785-0799 (Fax)



MATCHLINE ~ SEE SHEET 1

MATCHLINE ~ SEE SHEET 1

N:\117570\DRAINAGE\DWG\117570-EX-IMP.dwg, 2/16/2022, 3:42:38 PM, 1:1








BASIN RUNOFF			
BASIN	(Q5 CFS)	(Q100 CFS)	ACREAGE
A1	7.7	19.3	5.15
A2	1.7	4.0	1.01
B1	4.0	14.3	4.69
B2	4.2	12.1	3.16
C	5.9	19.0	6.00
D	3.8	11.1	3.27
E	2.9	13.9	5.09
F1	4.5	8.9	1.65
F2	2.5	4.9	0.91
G	4.4	10.2	2.50
H	5.5	12.8	3.11
J1	2.0	4.2	0.92
J2	2.7	6.6	1.65
K	4.3	9.7	2.30
L	3.3	6.6	1.20
M	2.6	5.4	1.19
M2	0.8	1.4	0.18
N	6.8	15.1	3.65
P	4.1	8.2	1.53
Q	1.2	2.4	0.42
R	3.8	8.4	1.64
S-1	0.8	5.3	2.13
S-2	0.8	5.1	2.23
S-3	0.4	2.7	1.14
S-4	0.6	4.2	1.63
S-5	1.2	7.7	2.92
T	2.7	9.2	2.69
U	3.2	7.2	1.28
V	3.2	7.5	1.61
Z1	1.5	5.1	1.30
Z2	2.1	5.5	1.40
EX-D	0.4	2.7	1.00
OS-1A	7.1	47.5	23.26
OS-1B	7.5	50.6	24.79
OS-1C	3.2	21.5	9.91
OS-1D	1.8	12.2	5.52
OS-1E	1.0	6.9	2.76
OS-1F	0.1	0.5	0.16

DESIGN POINT SUMMARY				
DESIGN POINT	(Q5 CFS)	(Q100 CFS)	INLET SIZE	
1A	9.3	23.1	15' TYPE R AT-GRADE	
1B	4.4	21.8	15' TYPE R AT-GRADE	
2	3.6	17.6	15' TYPE R AT-GRADE	
3	5.6	22.4	15' TYPE R AT-GRADE	
4	3.5	17.7	15' TYPE R AT-GRADE	
5	2.7	17.6	15' TYPE R SUMP	
6A	4.5	8.9	5' TYPE R AT-GRADE	
6B	4.2	10.1	10' TYPE R SUMP	
7	3.3	9.6	SURFACE FROM FIL. 6	
8	1.7	4.0	SURFACE FROM FIL. 6	
9	7.6	19.6	15' TYPE R AT-GRADE	
10	5.6	18.5	15' TYPE R AT-GRADE	
11	2.0	9.2	10' TYPE R AT-GRADE	
12	4.3	9.7	10' TYPE R AT-GRADE	
13	2.8	11.4	10' TYPE R SUMP	
14	3.3	6.6	10' TYPE R SUMP	
15	3.2	6.5	5' TYPE R SUMP	
16	1.2	2.4	5' TYPE R SUMP	
17	6.8	15.1	15' TYPE R SUMP	
18	4.1	8.2	10' TYPE R SUMP	
19	59.1	137.8	FSD/SWQ POND 'A'	
20	4.4	48.5	SURFACE TO S. BEAVER	
21	7.7	51.9	TYPE D (N SERIES & DEPRESSED)	
22	8.2	60.6	TYPE D (N SERIES & DEPRESSED)	
23	3.4	36.5	TYPE D (N SERIES & DEPRESSED)	
24	2.3	16.6	TYPE C (DEPRESSED)	
25	2.1	14.1	TYPE C (DEPRESSED)	
26	22.7	172.4	SURFACE TO S. BEAVER	
27	3.0	11.7	SURFACE TO S. BEAVER	
28	3.2	7.5	SURFACE TO S. BEAVER	

PIPE RUN SUMMARY				
PIPE	Q5 (CFS)	Q100 (CFS)	PIPE SIZE	
1	7.5	13.8	24"	
2	5.6	13.4	24"	
3	13.1	27.2	30"	
4	8.8	15.1	24"	
5	2.0	6.9	18"	
6	23.4	48.3	36"	
7	2.7	17.6	EX. 24"	
8	4.5	8.9	EX. 18"	
9	17.6	55.3	EX. 30"	
10	4.2	7.1	18"	
11	2.8	11.4	18"	
12	3.3	6.6	18"	
13	10.0	24.4	30"	
14	33.1	72.1	42"	
15	4.4	14.6	24"	
16	37.5	86.7	42"	
17	3.6	13.1	24"	
18	40.9	99.2	42"	
19	1.2	2.4	18"	
20	41.7	100.7	42"	
21	3.2	6.5	18"	
22	44.7	106.9	48"	
23	6.8	15.1	24"	
24	10.5	22.5	24"	
25	53.8	126.1	48"	
26	4.4	48.5	30"	
27	7.7	51.9	30"	
28	8.2	60.6	36"	
29	15.9	112.4	48"	
30	3.4	36.5	30"	
31	19.2	148.0	48"	
32	2.3	16.6	24"	
33	21.2	162.3	48"	
34	2.1	14.1	24"	
35	22.7	172.4	48"	
36	5.6	14.9	24"	
37	3.5	13.1	24"	
38	2.7	3.7	18"	
39	11.3	30.9	30"	

**STORM SEWER FACILITIES:**  
 ALL EXISTING AND PROPOSED STORM SEWER IS REINFORCED CONCRETE PIPE (RCP).  
 ALL INLETS ARE CDDT TYPE R CURB INLETS AND CDDT TYPE C & D GRATED INLETS.  
 STORM MANHOLES ARE TYPE I AND TYPE II PER COUNTY DDM STANDARDS.  
 ALL MAINS AND INLETS COLLECTING WATER FROM PUBLIC R.O.W. WILL BE "PUBLIC".  
 ALL STORM SEWER OUTSIDE OF THE R.O.W., INCLUDING THE POND OUTFALL PIPE IS "PRIVATE".  
 THE EXISTING AND PROPOSED FULL SPECTRUM DETENTION FACILITIES ARE "PRIVATE".  
 PRIVATE FACILITIES ARE OWNED AND MAINTAINED BY THE FOREST LAKES METROPOLITAN DISTRICT.

	FOREST LAKES FILING NO. 7		
	DEVELOPED CONDITIONS DRAINAGE MAP BASIN - DESIGN POINT - PIPE TABLES		
DESIGNED BY	MAL	SCALE	DATE 10/05/21
DRAWN BY	MAL	(H) 1"= N/A	SHEET 4 OF 4
CHECKED BY	(V) 1"= N/A	JOB NO.	1175.70
<small>619 N. Cascade Avenue, Suite 200 (719)785-0790          Colorado Springs, Colorado 80903 (719)785-0799 (Fax)</small>			