

**Briargate Bridge at Sand Creek
Design Report
Sand Creek Drainageway**

Provide a signature block page:
Design Engineer's Statement:

El Paso County, Colorado

The attached drainage plan and report were prepared under my direction and supervision and are correct to the best of my knowledge and belief. Said drainage report has been prepared according to the criteria established by the County for drainage reports and said report is in conformity with the applicable master plan of the drainage basin. I accept responsibility for any liability caused by any negligent acts, errors or omissions on my part in preparing this report.

Prepared for:
SR Land, LLC
20 Boulder Crescent Suite 200
Colorado Springs, Colorado 80902

[Name, P.E. # _____]

Date

Owner/Developer's Statement:

I, the owner/developer have read and will comply with all of the requirements specified in this drainage report and plan.

Prepared by:
Celebrating 30 years
Kiowa
Engineering Corporation
7175 West Jefferson Avenue, Suite 2200
Lakewood, Colorado 80235
Ph: (303)692-0369

[Name, Title]

Date

[Business Name]

Kiowa Project No. 19032

[Address]

El Paso County:

April 29, 2022

Filed in accordance with the requirements of the Drainage Criteria Manual, Volumes 1 and 2, El Paso County Engineering Criteria Manual and Land Development Code as amended.

CDR-21-013

County Engineer / ECM Administrator

Date

Conditions:

TABLE OF CONTENTS

Table of Contents..... ii

Appendix Table of Contents..... iii

I. Executive Summary 4

II. General Location and Description..... 4

III. Project Background..... 5

IV. Previous Reports and Jurisdictional Requirements..... 5

V. Site Description..... 5

VI. Hydrology 6

VII. Hydraulics 6

VII. Hydraulic Design and Criteria 7

VIII. Hydraulic Modelling Results..... 9

IX. Scour Analysis 11

X. Construction PEmitting 11

XI. Drainage and Bridge Fees 11

XII. Phasing..... 12

XIII. Conclusions 12

Appendix Table of Contents..... 13

APPENDIX TABLE OF CONTENTS

Appendix A: Floodplain

Figure 1 Vicinity Map

Figure 2 Briargate Bridge Floodplain Workmap

Annotated FIRM

Appendix B: Hydrology

2018 MDDP Hydrology Existing Conditions Map

Appendix C: Drop Structure and Riprap Calculations

Appendix D: HECRAS Hydraulic Modelling

Appendix E: Contech Bridge Design Analysis

Appendix F: Improvement Costs

I. EXECUTIVE SUMMARY

This design report presents descriptions and design calculations for the Briargate Parkway crossing of Sand Creek in the Sterling Ranch Development. The crossing consists of a bridge with associated upstream and downstream channel improvements that will provide a transition to the natural channel of Sand Creek. A separate report by others will address design, drainage, and water quality design of the Briargate Parkway. Design elements in the descriptions below and associated documents in the Appendix include floodplain analysis, hydrology, design calculations, hydraulic modelling results.

II. GENERAL LOCATION AND DESCRIPTION

The proposed crossing consists of a 43-foot wide Conspan steel arch bridge sized to convey 100-year frequency flows without resulting in increases to the effective base flood elevations (BFEs) for Sand Creek. Two grouted sloping boulder (GSB) drop structures are proposed upstream of the bridge crossing to provide necessary grade control for the bridge. The current incised natural channel upstream and downstream of the bridge will be graded to provide stable 4:1 side embankment slopes and adequate capacity for major storm flows. The proposed channel revision, including the 228-foot long Conspan bridge crossing, will extend for approximately 625 feet along Sand Creek. The proposed channel and bridge improvements lie within El Paso County. The location of the site is shown on Figure 1 of the Appendix.

Upon the completion of the crossing and acceptance by El Paso County and Sterling Ranch Metropolitan District, easements and or tracts will be dedicated for the purposes of maintenance access. The bridge and channel work will occur adjacent to Tracts A, B, and D of Sterling Ranch Filing No. 1. Operation and maintenance of the bridge will be performed by El Paso County while the channel will be the responsibility of the Sterling Ranch Metropolitan District. A "No-Rise" floodplain certification study will be conducted in lieu of a CLOMR submittal to FEMA. However, a LOMR submittal will be required after construction to account for the floodplain revision. No residential lots within future Sterling Ranch Filings that will lie within the 100-year floodplain.

The bridge over Sand Creek at Briargate Parkway is included within the design plans. The bridge consists of a Conspan steel arch structure that have the capacity to pass the 100-year discharge. The typical road right-of-way is 130 feet for Briargate Parkway. The ultimate roadway section for Briargate Parkway as shown on the roadway design plans includes four 12-foot lanes and a 16-foot raised median, Type A curb and gutter, and 8-foot and 10-foot detached sidewalks. Protective guardrails as shown on the drawings have been designed in conformance with Colorado Department of Transportation M-standards.

Once the bridge and roadway facilities are completed and accepted by El Paso County, El Paso County will assume maintenance responsibility for the structures and roadways. A deed will be provided to transfer ownership to the County. The developer intends to request reimbursement for the cost to construct the bridges and drainageway facilities, or request credit against future drainage and bridge fees. Reimbursement will be processed in accordance with sections 1.7 and 3.3 of the Drainage Criteria Manual (DCM). The drainageway facilities will be operated and maintained by the Sterling Ranch Metropolitan District.

III. PROJECT BACKGROUND

Sand Creek within Sterling Ranch is a natural drainageway at his time that was shown to be stabilized in the Sterling Ranch Master Development Drainage Plan (MDDP). The MDDP showed Sand Creek to be reconfigured into a trapezoidal channel section capable of conveying the 100-year discharge as listed in the MDDP. The original channel design was a benched trapezoidal channel with numerous drop structures to provide grade control. However, after subsequent consideration by El Paso County and the Army Corps of Engineering, the decision was made to provide a design mimicking the current natural configuration of the channel. The present average slope of the drainageway within the design reach is 1.8 percent. As seen from the Briargate Bridge Plan and Profile, two drop structures upstream of the bridge were designed to reduce the channel slope through the bridge reach to 0.2 percent. Riprap channel and embankment lining through the bridge reach will provide erosion protection during major storm events.

IV. PREVIOUS REPORTS AND JURISDICTIONAL REQUIREMENTS

The basis for the development of the design has been developed from referencing the following reports:

1. *Sterling Ranch Master Development Drainage Plan (MDDP), prepared by M & S Civil Consultants, July 2018.*
2. *Sand Creek Drainage Basin Planning Study (DBPS), prepared by Kiowa Engineering, 1996.*
3. *City of Colorado Springs and El Paso County Drainage Criteria Manual, 1987.*
4. *El Paso County Engineering Criteria Manual, most current version.*
5. *City of Colorado Springs Drainage Criteria Manual, May 2014.*
6. *The City of Colorado Springs and El Paso County Flood Insurance Study (FIS), prepared by the Federal Emergency Management Agency, effective 2018.*
7. *Sterling Ranch Channel Improvements and Mitigation Plan, prepared by Core Consultants, October 2015.*
8. *Master Development Drainage Plan for Sterling Ranch, M&S Civil Consultants, October 2018.*

V. SITE DESCRIPTION

The Sand Creek floodplain within the Briargate Bridge reach is well vegetated with native grasses that are in fair to good condition that exists on the floodplain overbanks and within the greater valley in general. There is little evidence of active invert degradation or bank sloughing except for the channel bends that occur at the location of future Sterling Ranch Road. Current longitudinal slope is approximately 1.4 percent. There is presently no base flow in this segment. There are presently no developed lots that lie within the 100-year floodplain. Lots in the Homestead at Sterling Ranch Filing No. 2 and Branding Iron at Sterling Ranch Filing No. 2 subdivisions do not encroach into the 100-year floodplain.

A 24-inch water line is proposed to cross the drainageway just upstream of future Briargate Boulevard. The water and wastewater facilities that may impact the drainageway are all owned and maintained by the Sterling Ranch Metropolitan District.

VI. HYDROLOGY

Hydrology for use in determining the typical channel sections shown on the plans were obtained from Reference 6. The 100-year discharges shown in Reference 6 is 2,600 cubic feet per second. The 100-year peak discharges from references 1 and 2 were reviewed as well. A comparison of peak discharges is presented below.

Existing Development Condition Peak Discharges

Sand Creek at Sterling Ranch

Location: South Property Line (cfs)	5yr	10yr	100yr
City of Colorado Springs FIS	NR	1,200	2,600
Sand Creek DBPS	NR	770	2,620
Sterling Ranch MDDP	435	713	1,912

The above listed discharges all assume existing, or pre-development conditions. The hydrology used in the FIS was obtained from a Soil Conservation Service study conducted in 1975 for the Sand Creek watershed using the "SCS method. The hydrology developed in the DBPS also used the SCS method and obtained similar results. The MDDP used the U. S. Army Corps of Engineers HEC-1 hydrograph model and the SCS curve numbers to develop the peak discharges shown above. The MDDP applied a Type II storm distribution as proposed to the Type IIA distribution applied in the FIS and DBPS. This will typically cause peak discharges to decrease 10 to 15 percent. As the difference in the peak discharges cause relatively small differences in the hydraulic design the channel and the bridges, the FIS 100-year discharge was used in the hydraulic design of the channel and bridge improvements. According to the criteria set forth in Reference 4, the low flow channel was sized using 10 percent of the 100-year discharge, or 260 cubic feet per second.

The assumption that FSD will be required for all future development is reflected in the use of the existing development discharges in this design. There is a good correlation between the FIS and 1996 DBPS 100-year discharges for the segment of Sand Creek subject to this design. The future FSD's within Sterling Ranch will be publicly operated and maintained facilities by the Sterling Ranch Metropolitan District.

VII. HYDRAULICS

The goal of the bridge crossing design was to provide adequate conveyance capacity for the effective 100-yr frequency flows per FEMA and avoid any increase in the effective BFEs for the Sand Creek Floodplain. In addition, the proposed crossing was designed to produce flow characteristics that meet El Paso County criteria. Two grouted sloping boulder drop structures are proposed upstream of the crossing to lower the channel invert and provide grade control through the crossing reach. In addition to the grouted boulders, the entire invert upstream, through the proposed bridge, and downstream outlet are to be riprap lined. The bridge, a Conspan 58S steel arch, will convey flows at a depth of 5.8 to 7.6 feet with freeboard to the crown in excess of 14 feet. The excess height of the bridge was required to match the roadway grade for Briargate Parkway and provide necessary invert elevation for the channel.

The hydraulic design of the bridge crossing of Sand Creek performed using with US Army Corps of Engineers HEC-RAS modeling system version 6.1. A corrected effective model was

developed to establish existing conditions and provide a basis for comparison with the proposed conditions model. The downstream tie-in with the effective FIS model is located at section 63+79 of project mapping which corresponds to FIS section DG shown on the FIRM. Starting water surface elevations for the proposed model were taken from the effective model (NGVD 29 elevation datum to match project mapping). The upstream tie-in occurs at section 74+11 and corresponds to FIS section DI shown on the FIRM. The 100-year water surface elevation of the corrected effective and proposed models match the effective within 0.0 feet. The corrected effective model 100-year delineation closely matches the effective floodplain as shown on the Annotated FIMR in the Appendix.

The model was used to determine the 100-year hydraulic grade line shown on the plan and profiles. The 100-year profile for the FIS hydrology has been determined. The location for the proposed 100-year floodplain using FIS hydrology has been presented on the plan view of the design plans and on the grading plan. Appendix A of this report has the floodplain maps that show the effective 100-year floodplain. The locations for HEC-RAS cross-sections are shown on the design profile. The HEC-RAS model cross-sections are also contained within Appendix A. The summary output for the 10-, 50-, 100-year and 500-year recurrence intervals have been included in the Appendix of this report.

A riprap apron is included on the downstream end of the bridge to prevent channel degradation and undercutting of the bridge and wingwalls. A sheet pile cutoff wall is included on the downstream end of the riprap apron extending one foot above the proposed 100-year water surface.

VII. HYDRAULIC DESIGN AND CRITERIA

A "No-Rise" floodplain certification study will be submitted in lieu of a CLOMR submittal to FEMA. However, a LOMR submittal will be required after construction to account for the floodplain revision. There are no residential lots within future Sterling Ranch Filings that will lie within the 100-year floodplain.

Freeboard (between bridge low chord and 100-year design flow water surface) for the Briargate bridge is in excess of 10 feet and well above the 2-foot minimum per section 6.4.2 of the El Paso County Drainage Criteria Manual bridge.

Analysis of bridge scour was performed at upstream and downstream cross sections. Since the Conspan crossing structure is entered as a culvert, the bridge scour analysis was not available in the HEC-RAS program. Therefore, the shear force variable, also referred to as tractive force, was used to determine the adequacy of riprap erosion protection shown on the design plans.

Presented on the design plans associated with this design memorandum are the proposed drainageway conditions. Design criteria for the project are summarized as follows:

Channel design slope:	0.2 percent
Maximum drop height:	4 feet
Manning's n-values:	.025-.035
Froude number-(excluding crests of drops):	0.75
Permissible shear stress: channel and embankment:	
Type M soil riprap	5.0 psf

Drop Structure Design

The drops will be constructed using grouted boulders. The selection of grouted boulders was chosen to address long-term durability of the drop. The Grouted Sloping Boulder (GSBD) design follows the criteria included in the Mile High Flood District's Urban Storm Drainage Criteria Manual (USDCM). Two 4-foot-high GSBD's are proposed for this reach of Sand Creek. The longitudinal slope of the drop face is designed at 5:1 (USDCM Criteria is 4:1 maximum). Calculations were performed to determine the boulder size within the grouted sloping boulder drops. The minimum boulder size for the drop structures will be 30-inches. These boulders must be carefully placed to create a stepped appearance which helps to increase roughness. The boulders will be placed on either undisturbed soil, compacted subgrade or shallow bedrock (where encountered). Full penetration of grout around the lower one-half of the rock is essential for successful grouted boulder performance. The grout should be injected to a depth equal to one-half of the boulders being used and keep the upper one-half ungrouted and clean. Typically, the grout will not extend to the top of the boulders.

A grout cutoff wall will be located at the upstream end of each drop approach, for the full width of the drop, to minimize seepage from occurring under the structure and possible uplift forces. The cutoff wall will be installed to the specified depth below the proposed channel invert. A 30-inch to 36-inch grouted boulder sill will be installed at the downstream end of the drops. Weep drains will be installed in the drops to release hydrostatic pressure from under the drops and reduce the uplift forces on the grouted channel lining.

HEC-RAS and specific force calculations under both supercritical and subcritical flow regimes were used to determine the hydraulic jump location along the drops, and the stilling basin length and depth. The analysis was completed using varying flowrates such as for the 100-year, 10-year and low flow conditions, to determine the controlling hydraulic jump location (located the farthest downstream) and longest jump length for each drop. The controlling storm event for each drop is included in Appendix C. The 100-year storm event was the controlling condition for the upstream drop. However, due to backwater effects of the arch culvert, the downstream drop is submerged during a 100-year storm. The 10-year storm event is therefore the controlling condition for sizing the drop basin. Riprap will be placed downstream of the sill for a minimum distance of 10-feet to minimize erosion that may occur due to secondary currents.

Seepage analyses using the Lane's Weighted Creep Method were completed to determine the upstream cutoff depth required at each drop. Due to the drops being in either close proximity to or within bedrock, a low Creep Ratio of 1.6 was used. Calculations show that a cutoff depth in addition to what the boulders provide is not needed. However, a minimum 2-foot cutoff depth below the bottom of boulders (or 4.5-feet below the channel invert elevation) is still recommended, and will help key each structure into the shallow bedrock where encountered.

Based upon the hydraulic calculations and USDCM, the following design criteria have been established for the grouted sloping boulder drops.

- Drop height (H_d)(elevation difference between crest and top of sill): 4.0-ft
- Typical trapezoidal or composite channel section to continue through drop. Grouted boulders to extend on each side to 1.0-ft vertically above the 100-year water surface elevation.
- Drop face slope: 5:1
- Boulder size: 30-inch minimum, with 30-inch to 36-inch boulders for sill.

- Grouted boulder bedding: Undisturbed soil or compacted subgrade. For areas where shallow bedrock is encountered, bedding will be a minimum 12-inch thick layer of 1-1/2" to 2-1/2" crushed rock.
- Approach length: 10-ft grouted boulders followed by 10-ft Type M soil riprap (2.0-ft thick), not buried along the channel bottom.
- Upstream cutoff wall depth: 4.5-ft grout cutoff wall, placed monolithically with grout placed for boulders.
- Weep drain system: Yes
- Stilling basin depth: 2.0-ft
- Stilling basin length: 20-ft
- Downstream length of riprap protection: Minimum of 10 linear feet of Type M soil riprap (2.0-ft thick), not buried along channel bottom.

Refer to Appendix C for drop structure design and rock sizing calculations.

Wherever soil riprap linings are proposed, rock sizing and freeboard criteria followed is in accordance with Chapter 8 of the Mile High Flood District's Urban Storm Drainage Criteria Manual, Equation 8-11.

A geotechnical investigation was conducted to support the design of the foundation for the bridge at Sterling Ranch Road and Briargate Parkway. The geotechnical report is included with this submittal. Two soil borings were drilled near the locations of the proposed footings for the bridges. Bedrock is shallow at Sterling Ranch Road and Briargate Parkway, so spread footings will be used. A precast bridge section has been chosen that has a 43-foot clear span and a 24.5-foot rise. The 100-year discharge can be passed through the bridge at a maximum depth of approximately 7.6 feet and headwater to depth of 0.31. The velocity during a 100-year event at the upstream and downstream reach of the bridge is 5.9 feet per second and 12.1 feet per second, respectively. A Type M void-filled riprap invert will be provided at each bridge crossing. The construction of the improvements shown on the plans will prevent erosion due to changes in the channel hydraulic characteristics of the bridge and extend downstream to an extent where current conditions are matched.

VIII. HYDRAULIC MODELLING RESULTS

HECRAS model output including tables and sections are included in the Appendix. The results indicate that the proposed Briargate crossing has conveyance capacity is well in excess during 100-year storm events. As seen in the following, the 100-year water surface elevations are below those of corrected effective model throughout the revised channel reach. Freeboard from the crown of the Conspan crossing is well in excess of 2 feet per El Paso County criteria. HECRAS model output is included in the Appendix.

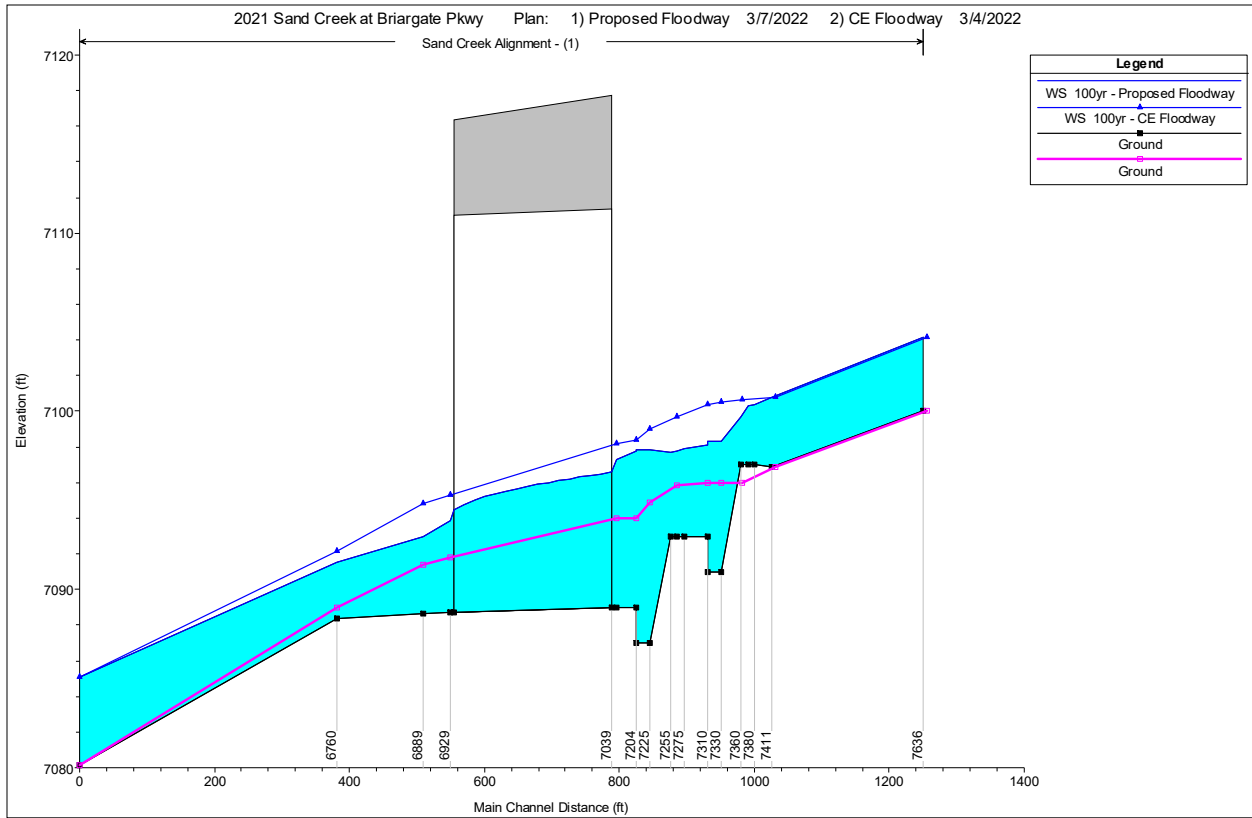

HECRAS profile comparison of proposed (blue filled) and existing 100-yr WSEL

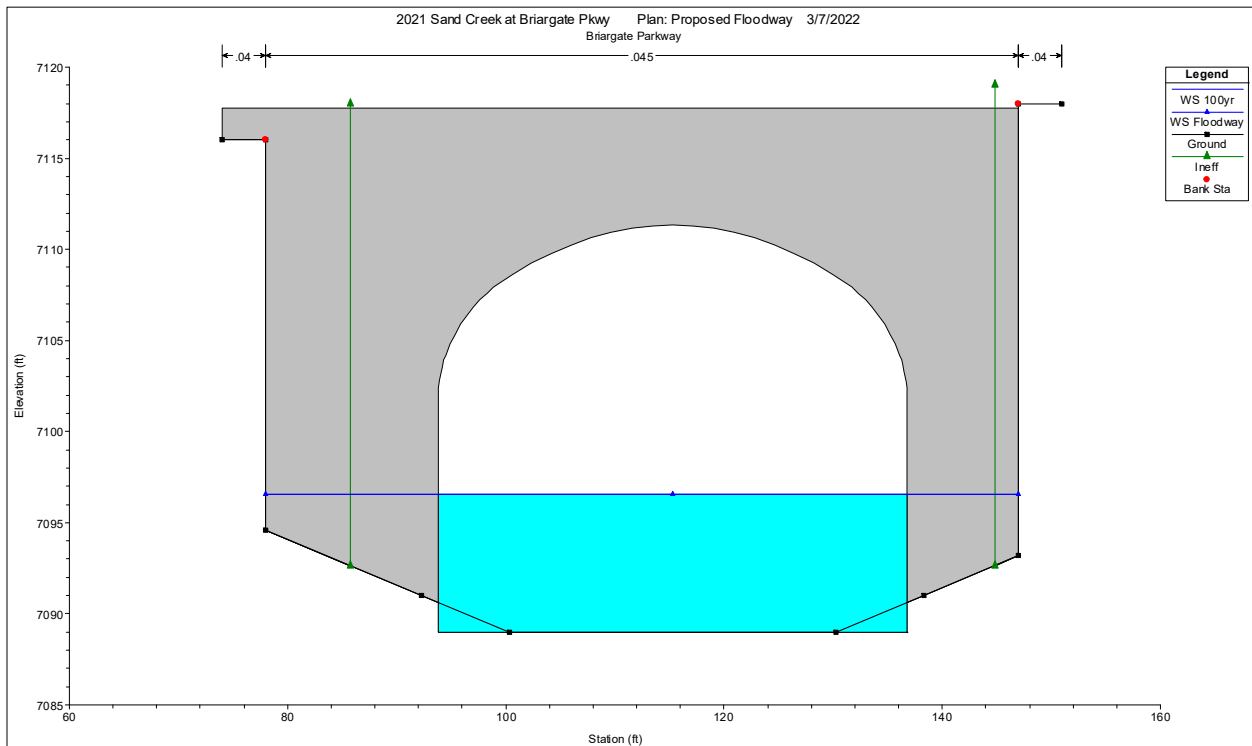

Upstream face Conspan crossing 100-yr WSEL.

IX. SCOUR ANALYSIS

Scour analysis was performed to determine if bridge foundations and channel drop structures are susceptible to undermining during major storm events. Per CDOT Drainage Manual Section 10.4.3, the 500-year storm was used for scour analysis of the Conspan crossing abutment and foundation. Scour analysis in HECRAS is limited to bridges and therefore not available for the Conspan crossing modelled as a culvert. Therefore the shear stress variable calculated in HECRAS was used to determine the likelihood of scour. The crossing design includes riprap lining of the channel invert with added protection for the embankment on the downstream end of the crossing. This is shown on Figure 2 of Appendix A.

As seen from Table 1 below, shear stress through the bridge reach is well below 5 lbs/ft² tolerance for the type M soil riprap lining of the channel bottom and embankments during 100-year and 500-year simulations. Velocities downstream of the bridge are comparable to existing conditions and will not result in an increase of erosive conditions.

Table 1 HECRAS Shear Stress and Velocity at Proposed Conspan Crossing

		100-Yr Profile		500-Yr Profile	
Location	Section	Maximum Velocity (ft/s)	Shear Stress Channel(lb/ft ²)	Maximum Velocity (ft/s)	Shear Stress Channel(lb/ft ²)
30' Upstream of Bridge	7205	3.5	0.4	3.7	0.4
Upstream Bridge Face	7175	5.9	1.0	6.8	1.3
Downstream Bridge Face	6929	12.1	4.0	13.7	4.7
40' Downstream of Bridge	6889	10.4	1.5	11.4	1.7
69' Downstream of Bridge	6760	9.3	1.3	10.2	1.4

Note: Permissible shear stress Type M soil riprap is 5 lb/ft²

X. CONSTRUCTION PERMITTING

The following permits are anticipated to allow for the construction of the project as shown on the design plans. A copy of the Sterling Ranch 404 Permit is included within the Appendix.

USACE notification of project in conformance with 404 permit - USACE

No-Rise Floodway Certification, Floodplain Development Permit – Pikes Peak Regional Building Department

Grading and Erosion Control Permit (ESQCP) – El Paso County

Construction Stormwater Discharge Permit – CDPHE

Construction Dewatering Permit - CDPHE

Letter of Map Revision (post construction) - FEMA

XI. DRAINAGE AND BRIDGE FEES

The Sterling Ranch Development and specifically Sterling Ranch East lies wholly within the Sand Creek drainage basin. Drainage and bridge fees have been established by the County for the

Sand Creek drainage basin for assessment against platted land within the watershed. The bridge will be public and owned and maintained by the El Paso County upon acceptance. The costs for the public drainageway improvements are reimbursable or creditable against drainage and bridge fees owed when land within Sterling Ranch is platted. Reimbursement of drainage and bridge improvements require approval through the DCM reimbursement process. Construction of the bridge at Sterling Ranch Road and at Briargate Parkway will be creditable against bridge fees owed pending approval through the DCM reimbursement process.

The 1996 Sand Creek DBPS identifies the project section as reaches SC-8 and SC-9 with two check structures for conveyance improvements and a (4) 10'W x 8'H CBC crossing at Briargate Parkway. Adjusted for 2022 dollars, the total cost for the 1996 DBPS improvements is \$359,731. The total cost estimate for the current crossing and channel improvement design is \$1,610,466. Detailed cost estimates and comparison to the 1996 DBPS are included in Appendix F.

The current 2021 drainage and bridge fees for the Sand Creek drainage basin are as follows:

Drainage Fee:	\$20,387 per impervious acre
Bridge Fee:	\$ 8,339 per acre

XII. PHASING

Construction of the drainage and bridge facilities shown on the plans is to be completed all at once and no phasing of the construction is proposed. The construction will commence prior to or concurrent with the subdivisions east of Sand Creek.

XIII. CONCLUSIONS

The development of the future subdivisions to the east requires the Briargate Bridge crossing of Sand Creek. Per direction of El Paso County and the Army Corps of Engineers, improvements to Sand Creek through the Sterling Ranch Development were limited to stabilize the channel upstream and downstream reach of the proposed Briargate Boulevard Bridge. Results of hydraulic analysis demonstrate that the channel and Conspan crossing have adequate capacity to carry effective 100-year flows without causing an increase to existing water surface elevations. Shear stress analysis indicates that the riprap channel protection is sufficient to prevent undermining of the structure during major storm events and will not result in adverse impacts to the downstream natural channel compared to existing conditions.

APPENDIX TABLE OF CONTENTS

Appendix A: Floodplain

Figure 1 Vicinity Map

Figure 2 Briargate Bridge Floodplain Workmap

Annotated FIRM

Appendix B: Hydrology

2018 MDDP Hydrology Existing Conditions Map

Appendix C: Drop Structure and Riprap Calculations

Appendix D: HECRAS Hydraulic Modelling

Appendix E: Contech Bridge Design Analysis

Appendix F: Improvement Costs

Appendix A: Floodplain

Figure 1 Vicinity Map

Figure 2 Briargate Bridge Floodplain Workmap

Annotated FIRM

**MESA RIDGE DEVELOPMENT
 MASTER DEVELOPMENT DRAINAGE PLAN
 VICINITY MAP
 FOUNTAIN, COLORADO**

Project No.:	21027
Date:	04/06/2022
Design:	SAB
Drawn:	MTR
Check:	SAB
Revisions:	

Fig. 1

← Wrong project

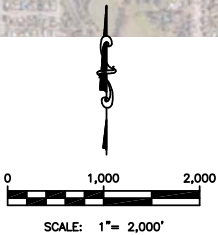
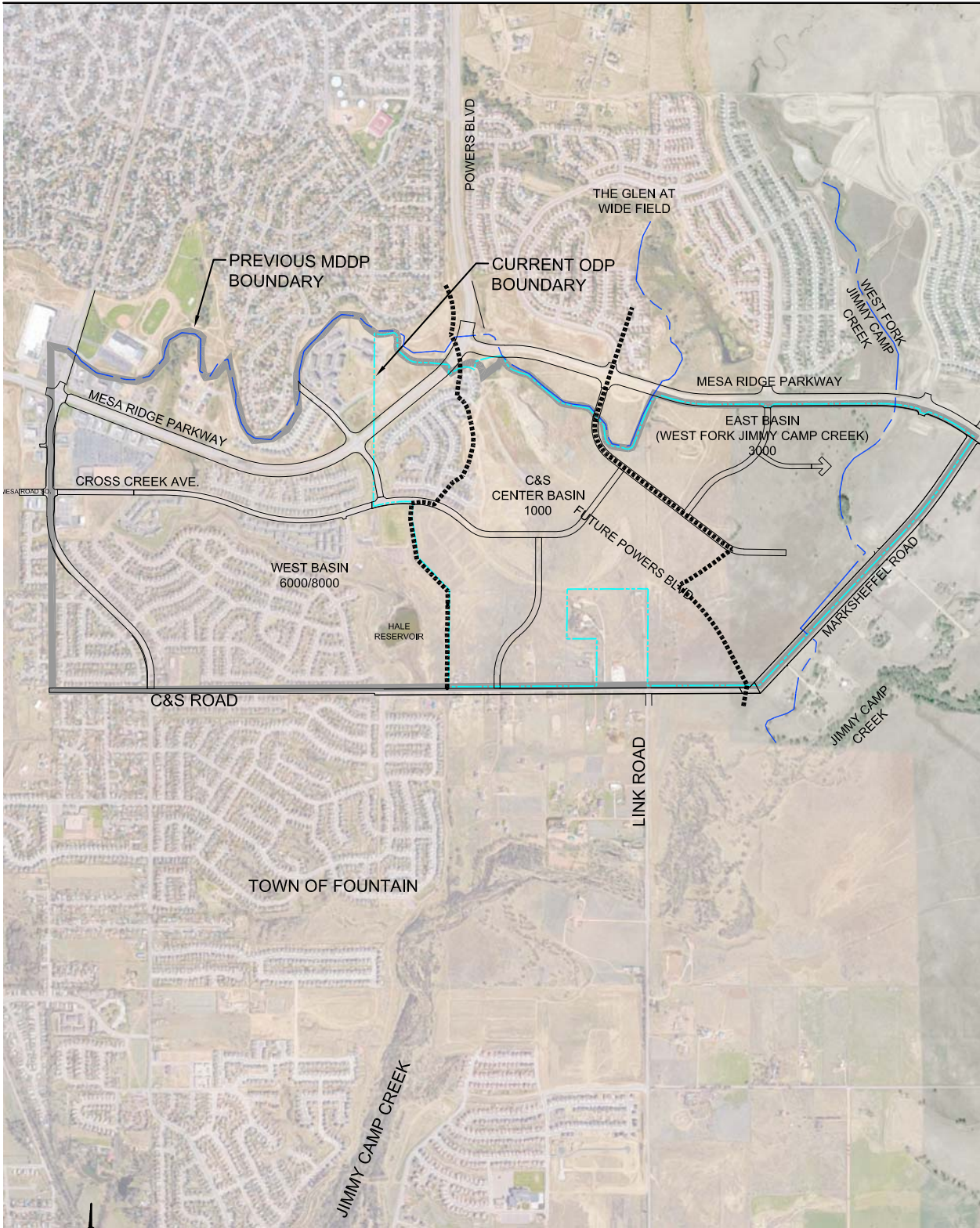

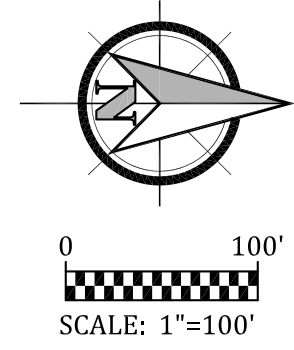
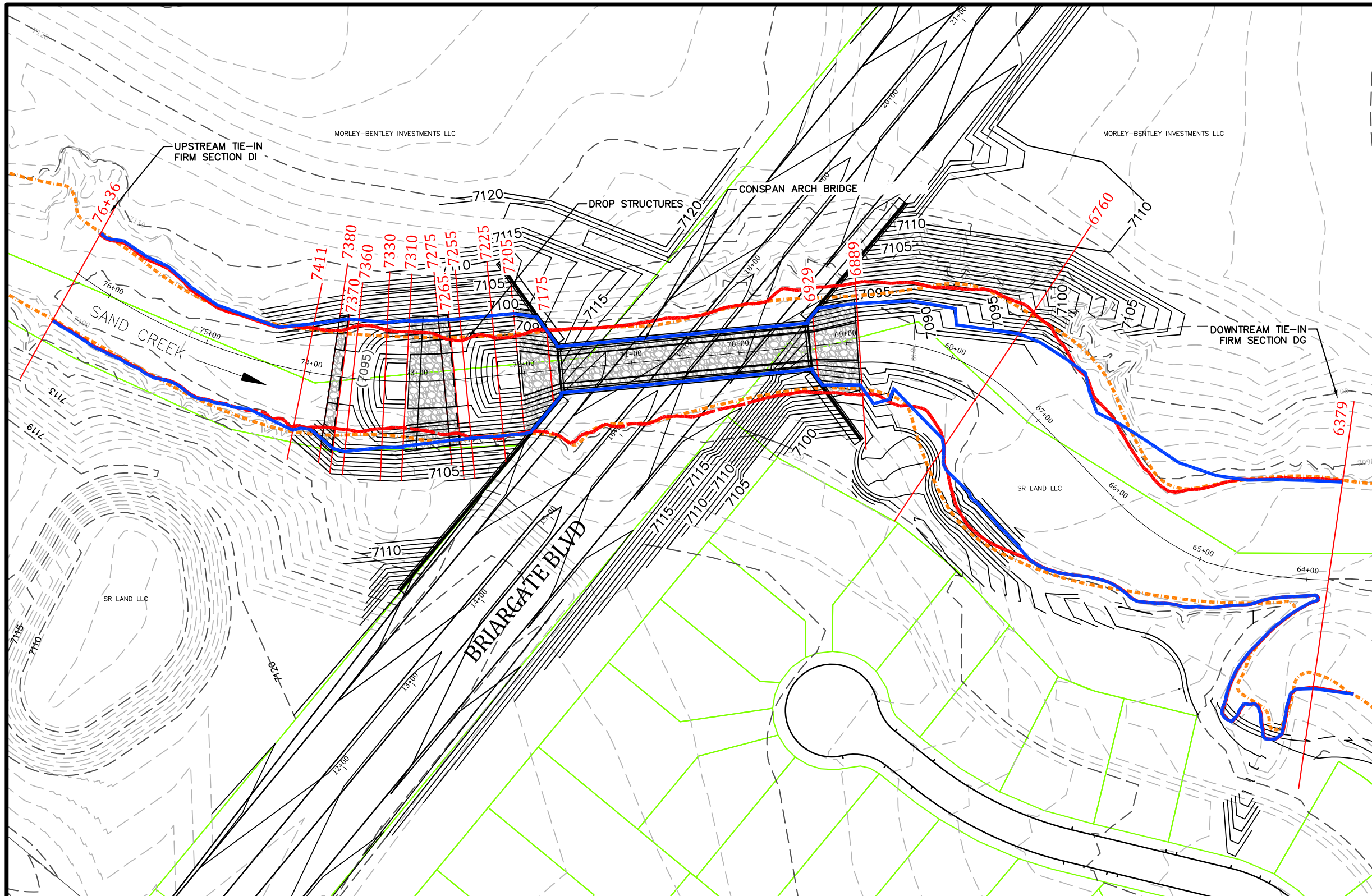

Kiowa
 Engineering Corporation
 7175 West Jefferson Avenue, Suite 2200
 Lakewood, Colorado 80235
 (303) 692-0369





LEGEND	
	EFFECTIVE 100-YEAR
	CORRECTED EFFECTIVE 100-YEAR
	PROPOSED 100-YEAR
	PARCEL

FIGURE 2
 FLOODPLAIN WORKMAP
 BRIARGATE BRIDGE AT SAND CREEK



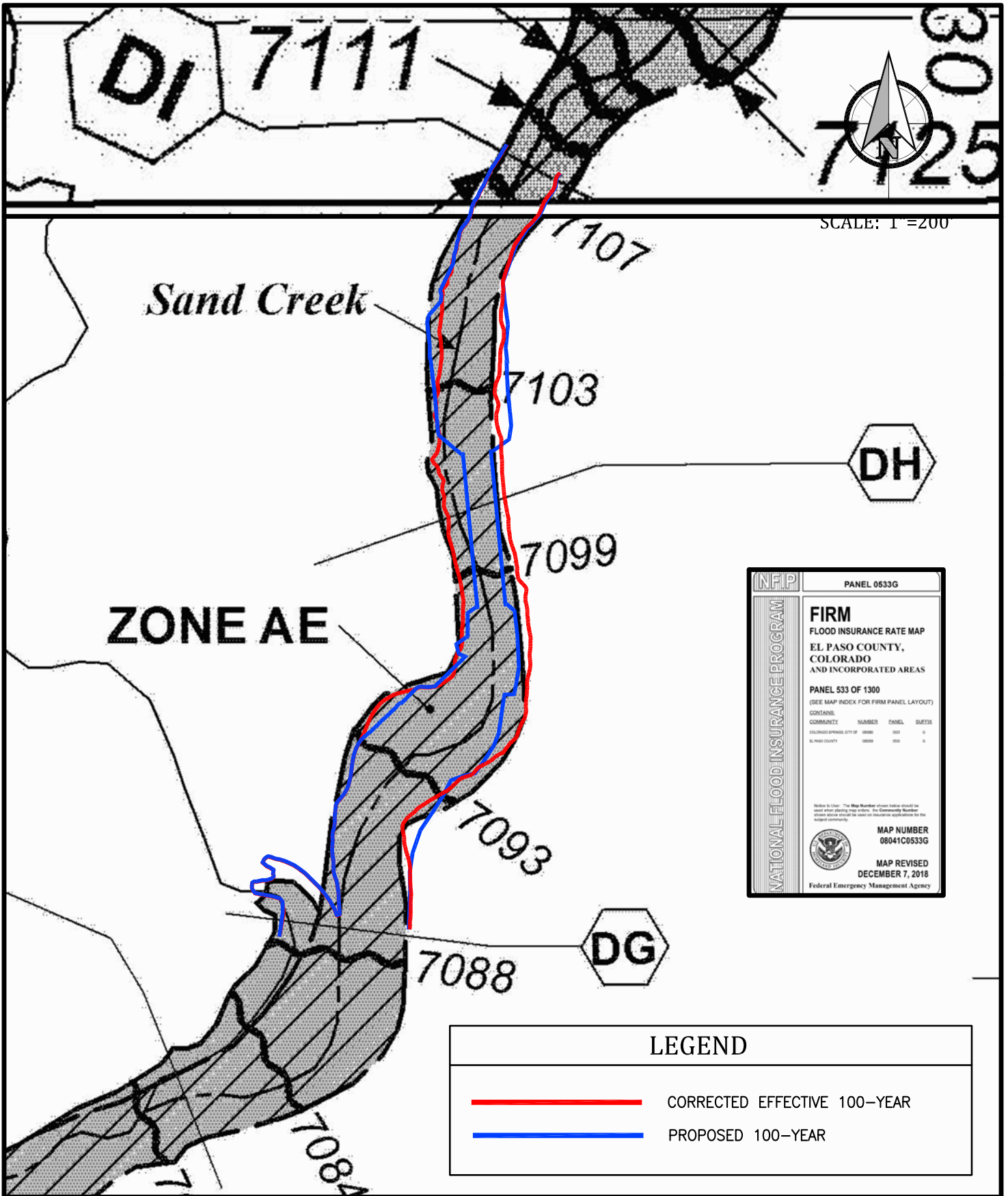

SCALE: 1"=200'

ZONE AE

Sand Creek

NATIONAL FLOOD INSURANCE PROGRAM	PANEL 0533G		
	FIRM		
	FLOOD INSURANCE RATE MAP		
	EL PASO COUNTY, COLORADO AND INCORPORATED AREAS		
	PANEL 533 OF 1300 (SEE MAP INDEX FOR FIRM PANEL LAYOUT)		
	CONTAINS:		
	COMMUNITY	NUMBER	PANEL SUFFIX
	EL PASO COUNTY	0800	000 0
	EL PASO COUNTY	0800	000 0
	<small>Notes to User: The Map Number shown below should be used when quoting map orders. The Community Number shown above should be used on insurance applications for the subject community.</small>		
 MAP NUMBER 08041C0533G			
MAP REVISED DECEMBER 7, 2018 Federal Emergency Management Agency			

LEGEND	
	CORRECTED EFFECTIVE 100-YEAR
	PROPOSED 100-YEAR

SAND CREEK ANNOTATED FIRM
BRIARGATE BRIDGE
 PLAN NAME

MARCH 2022
 PROJECT NO. 19032

Kiowa
 Engineering Corporation

7175 West Jefferson Avenue, Suite 2200
 Lakewood, Colorado 80235
 (303) 692-0369

Appendix B: Hydrology

2018 MDDP Hydrology Existing Conditions Map

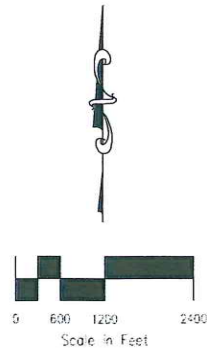

LEGEND

- BASIN ID - SC3-77
- DESIGN POINT - 87
- REACH IDENTIFIER - RT-17A
- BASIN BOUNDARY - - - - -
- EAST FORK SAND CREEK - - - - -
- BASIN BOUNDARY - - - - -
- FLOW DIRECTION - →

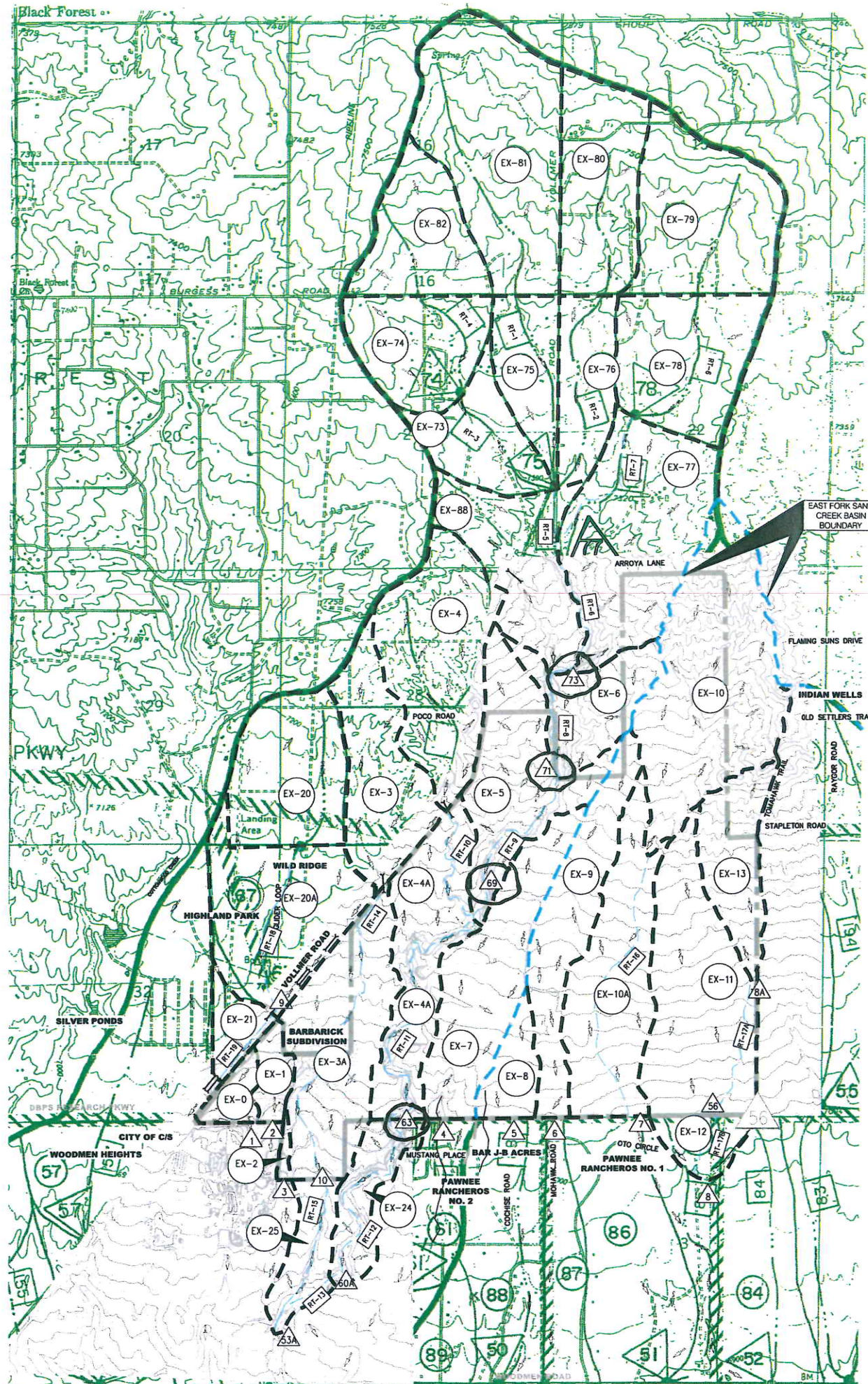

Discharge Summary
Sand Creek

DP-63
SOTL 1912

DP 69
@ Brandyville 1870

DP 71
No PL 1637

BASIN SUMMARY

BASIN	CN	AREA (acres)	AREA (sq mi)	Q ₅ (cfs)	Q ₁₀ (cfs)	Q ₂₅ (cfs)	Q ₅₀ (cfs)	Q ₇₅ (cfs)	Q ₁₀₀ (cfs)
EX-0	62	23.8	0.037	5.0	8.2	13.0	19.6	25.7	32.2
EX-1	62	25.7	0.040	4.8	7.9	12.4	18.7	24.5	30.9
EX-2	62	5.5	0.009	1.1	1.8	2.8	4.3	5.6	7.1
EX-3	62	136.8	0.214	22.0	36.4	57.6	86.9	114.0	143.1
EX-3A	61	188.1	0.294	28.3	47.4	75.7	115.1	152.2	192.6
EX-4	62	192.0	0.300	30.1	49.9	79.1	119.5	157.0	197.3
EX-4A	62	151.5	0.237	24.7	40.8	64.4	97.0	127.2	160.1
EX-5	62	153.9	0.240	24.2	40.0	63.4	95.9	125.9	158.2
EX-6	62	90.2	0.141	15.3	25.5	40.1	60.7	79.9	100.5
EX-7	56	165.0	0.258	11.6	21.5	37.5	60.9	83.1	107.4
EX-8	45	42.0	0.066	0.5	1.7	4.5	9.4	14.5	20.5
EX-9	54	131.9	0.206	12.2	23.9	43.1	70.9	97.0	125.2
EX-10	60	270.7	0.423	32.7	56.0	91.1	140.1	185.9	236.1
EX-10A	41	179.3	0.280	0.6	2.2	7.3	17.4	29.1	43.1
EX-11	43	209.3	0.327	18.0	29.8	47.7	73.4	98.3	126.1
EX-12	51	39.5	0.062	2.2	5.1	10.1	17.7	25.1	33.3
EX-13	55	89.3	0.139	7.7	15.2	27.1	44.2	60.5	78.4
EX-20	62	143.4	0.224	25.4	42.1	66.7	100.7	132.3	166.2
EX-20A	64	179.7	0.281	32.2	51.9	80.5	119.8	155.9	194.6
EX-21	65	33.3	0.052	8.6	13.5	20.7	30.5	39.4	49.0
EX-24	59	63.1	0.099	9.5	16.6	27.5	42.9	57.4	73.0
EX-25	43	54.4	0.085	0.3	1.5	4.8	10.7	17.2	25.1
EX-73	63	90.0	0.141	16.4	26.4	41.3	62.1	81.3	102.0
EX-74	63	119.7	0.187	22.3	36.5	57.3	85.9	112.3	140.7
EX-75	63	79.3	0.124	13.1	21.5	33.7	50.5	66.1	82.8
EX-76	63	86.4	0.135	14.2	23.1	36.4	54.6	71.4	89.6
EX-77	62	230.6	0.360	34.7	56.9	90.6	137.5	180.9	227.7
EX-78	63	155.6	0.243	28.1	45.3	70.6	106.2	139.1	174.5
EX-79	63	189.0	0.295	34.9	57.0	89.5	134.3	175.6	220.1
EX-80	63	147.7	0.231	27.3	44.3	69.6	104.5	136.8	171.4
EX-81	62	262.9	0.411	42.6	70.2	111.0	167.4	219.6	275.7
EX-82	62	117.8	0.184	20.0	33.2	52.8	80.0	105.1	132.3
EX-88	62	139.2	0.217	22.2	36.7	58.0	87.6	115.0	144.4

DESIGN POINT SUMMARY (PEAK FLOW)

DESIGN POINT	AREA (ac)	Q ₅ (cfs)	Q ₁₀ (cfs)	Q ₂₅ (cfs)	Q ₅₀ (cfs)	Q ₇₅ (cfs)	Q ₁₀₀ (cfs)	LOCATION
DP-74	0.371	39.3	65.3	104.8	158.9	209.1	262.8	
DP-75	1.413	141.2	235.1	376.6	566.6	750.9	950.5	
DP-78	0.538	59.7	98.4	154.0	232.6	306.2	385.3	
DP-73	2.528	225.9	380.7	618.0	957.0	1260.4	1582.3	
DP-71	2.669	229.3	388.9	629.7	978.8	1277.3	1637.9	STERLING RANCH NORTHERN BNDY
DP-69	3.209	253.0	434.8	707.7	1100.0	1453.3	1870.4	
DP-63	3.446	251.4	430.7	713.1	1113.2	1496.2	1911.5	STERLING RANCH SOUTHERN BNDY
DP-10	0.508	36.5	56.0	106.4	162.9	220.6	287.2	COLORADO SPRINGS/EL PASO BNDY
DP-9A	0.557	55.3	94.3	150.3	227.7	299.5	380.5	VOLLMER/TAHITI DRIVE
DP-9	0.505	52.8	88.8	142.1	214.2	281.0	351.4	VOLLMER/LOCHWINNOCH LN
DP-8A	0.139	7.7	15.2	27.1	44.2	60.5	78.4	D/S STERLING RANCH EASTERN BNDY
DP-8	0.528	24.2	45.1	77.8	124.4	169.5	220.9	D/S STERLING RANCH SOUTHERN BNDY
DP-7	0.703	32.4	57.1	97.3	156.1	213.8	277.9	STERLING RANCH SOUTHERN BNDY
DP-6	0.206	12.2	23.9	43.1	70.9	97.0	125.2	STERLING RANCH SOUTHERN BNDY
DP-5	0.066	0.5	1.7	4.5	9.4	14.5	20.5	STERLING RANCH SOUTHERN BNDY
DP-4	0.258	11.6	21.5	37.5	60.9	83.1	107.4	STERLING RANCH SOUTHERN BNDY
DP-3	0.009	1.1	1.8	2.8	4.3	5.6	7.1	STERLING RANCH SOUTHERN BNDY
DP-2	0.040	4.8	7.9	12.4	18.7	24.5	30.9	STERLING RANCH SOUTHERN BNDY
DP-1	0.037	5.0	8.2	13.0	19.6	25.7	32.2	STERLING RANCH SOUTHERN BNDY
DP-60A	3.545	247.7	430.2	707.1	1113.0	1496.6	1913.5	FUTURE MARKSHEFFEL X-ING
DP-56	0.466	23.2	42.5	71.9	115.6	157.4	202.9	STERLING RANCH SOUTHERN BNDY
DP-53A	4.138	282.1	454.0	763.2	1196.5	1609.8	2061.5	SAND CREEK AND POND 3

DESIGN POINT SUMMARY (VOLUME)

DESIGN POINT	AREA (ac)	V ₅ (ac-ft)	V ₁₀ (ac-ft)	V ₂₅ (ac-ft)	V ₅₀ (ac-ft)	V ₇₅ (ac-ft)	V ₁₀₀ (ac-ft)	LOCATION
DP-74	0.371	5.9	9.0	13.6	19.8	25.5	31.6	
DP-75	1.413	22.7	34.5	51.7	75.4	97.1	120.5	
DP-78	0.538	8.9	13.5	20.1	29.3	37.7	46.7	
DP-73	2.528	40.4	61.5	92.1	134.3	173.1	214.9	
DP-71	2.669	42.5	64.9	97.1	141.6	182.5	226.6	STERLING RANCH NORTHERN BNDY
DP-69	3.209	50.7	77.4	116.1	169.4	218.6	271.4	
DP-63	3.446	54.1	82.6	123.8	180.8	233.3	289.9	STERLING RANCH SOUTHERN BNDY
DP-10	0.508	7.6	11.7	17.6	25.8	33.4	41.6	COLORADO SPRINGS/EL PASO BNDY
DP-9A	0.557	9.3	14.1	21.1	30.7	39.4	48.8	VOLLMER/TAHITI DRIVE
DP-9	0.505	8.4	12.7	19.0	27.6	35.5	44.0	VOLLMER/LOCHWINNOCH LN
DP-8A	0.139	1.3	2.1	3.4	5.2	7.0	8.9	D/S STERLING RANCH EASTERN BNDY
DP-8	0.528	4.4	7.0	11.1	16.8	22.3	28.4	D/S STERLING RANCH SOUTHERN BNDY
DP-7	0.703	6.1	10.0	15.9	24.3	32.4	41.3	STERLING RANCH SOUTHERN BNDY
DP-6	0.206	2.4	4.0	6.3	9.6	12.7	16.0	STERLING RANCH SOUTHERN BNDY
DP-5	0.066	0.2	0.4	0.8	1.4	1.9	2.6	STERLING RANCH SOUTHERN BNDY
DP-4	0.258	2.6	4.2	6.7	10.2	13.5	17.2	STERLING RANCH SOUTHERN BNDY
DP-3	0.009	0.1	0.2	0.3	0.5	0.6	0.8	STERLING RANCH SOUTHERN BNDY
DP-2	0.040	0.6	0.9	1.4	2.1	2.7	3.4	STERLING RANCH SOUTHERN BNDY
DP-1	0.037	0.6	0.9	1.3	1.9	2.5	3.1	STERLING RANCH SOUTHERN BNDY
DP-60A	3.545	55.3	84.4	126.4	184.6	239.5	296.6	FUTURE MARKSHEFFEL X-ING
DP-56	0.466	4.0	6.3	9.9	14.9	19.8	25.1	SAND CREEK AND POND 3
DP-53A	4.138	63.0	96.4	144.7	211.8	273.9	340.9	SAND CREEK AND POND 3

Q₁₀₀ FIS = 2600 cfs

EFSC DBPS DESIGN POINT SUMMARY (PEAK FLOW)

DBPS DESIGN POINT	AREA (ac)	Q ₅ (cfs)	Q ₁₀ (cfs)
DP-50	0.32	47.0	195.7
DP-51 (BASIN 86)	0.33	17.7	74.1
DP-52	1.67	80.5	455.5
DP-56	0.79	63.6	265.0

Values reported from SCDBPS (DP 50, 51, 52 Not analyzed as a part of this study)
DBPS Reach 85(BasinID)=010-28.8cfs Q100=115.2cfs



20 BOULDER CRESCENT, SUITE 110
COLORADO SPRINGS, CO 80903
PHONE: 719.955.5485

2018 STERLING RANCH MDDP
EXISTING HYDROLOGIC CONDITIONS MAP

PROJECT NO. 09-002 FILE: \\dmg\Eng Exhibits\2018-MDDP-ExistCOND\SHMap.dwg
DESIGNED BY: DLM SCALE: DATE: 08-22-18
DRAWN BY: DLM HORIZ: NTS
CHECKED BY: VAS VERT: NTS

DM1

File: G:\090020\Sterling Ranch District\Eng Exhibits\2018-MDDP-ExistCOND\SHMap.dwg Plotstamp: 11/13/2018 1:52 PM

FOR LOCATING & MARKING GAS, ELECTRIC, WATER & TELEPHONE LINES
FOR BURIED UTILITY INFORMATION
48 HRS BEFORE YOU DIG
CALL 1-800-922-1987

Appendix C: Drop Structure and Riprap Calculations

Briargate Bridge at Sand Creek
Hydraulic Jump and Basin Length Calculations

4' Drop Structure A (Crest Station 73+60)

Hec Ras Mixed Flow Analysis (100-year)		Supercritical Analysis							Subcritical Analysis						
River Sta	Q Total	Min Ch El	W.S. Elev	Crit W.S.	Vel Chnl	Froude # Chl	Max Chl Dpth	Specif Force	W.S. Elev	Crit W.S.	Vel Chnl	Froude # Chl	Max Chl Dpth	Specif Force	
	(cfs)	(ft)	(ft)	(ft)	(ft/s)		(ft)	(cu ft)	(ft)	(ft)	(ft/s)		(ft)	(cu ft)	
Drop Crest	7360	2600	7097.00	7099.17	7099.72	11.38	1.45	2.17	1151.50	7099.72	7099.72	8.82	1.00	2.72	1088.12
	7359	2600	7096.80	7099.47	7099.57	9.26	1.07	2.67	1094.59	7099.57	7099.57	8.86	1.01	2.77	1092.22
	7358	2600	7096.60	7099.16	7099.42	9.98	1.19	2.56	1110.86	7099.42	7099.42	8.89	1.01	2.82	1096.46
	7357	2600	7096.40	7099.28	7099.28	8.92	1.01	2.88	1101.01	7099.28	7099.28	8.90	1.01	2.88	1100.98
	7356	2600	7096.20	7098.91	7099.14	9.85	1.16	2.71	1116.11	7099.14	7099.14	8.93	1.01	2.94	1105.68
	7355	2600	7096.00	7098.64	7098.99	10.43	1.25	2.64	1134.70	7098.99	7098.99	8.95	1.01	2.99	1110.59
	7354	2600	7095.80	7098.81	7098.85	9.13	1.03	3.00	1116.09	7098.85	7098.85	8.98	1.00	3.05	1115.66
	7353	2600	7095.60	7098.45	7098.70	10.00	1.17	2.85	1132.47	7098.70	7098.70	9.01	1.01	3.10	1120.80
	7352	2600	7095.40	7098.20	7098.55	10.52	1.25	2.80	1150.24	7098.56	7098.56	9.01	1.00	3.16	1126.17
	7351	2600	7095.20	7098.37	7098.41	9.22	1.03	3.16	1132.02	7098.41	7098.41	9.07	1.01	3.21	1131.59
Jump Begins	7350	2600	7095.00	7098.02	7098.25	10.05	1.16	3.02	1148.10	7098.26	7098.26	9.09	1.01	3.26	1137.28
	7349	2600	7094.80	7097.76	7098.12	10.57	1.24	2.96	1165.81	7098.12	7098.12	9.11	1.00	3.32	1142.91
	7348	2600	7094.60	7097.93	7097.96	9.30	1.03	3.33	1149.10	7097.97	7097.97	9.15	1.01	3.37	1148.70
	7347	2600	7094.40	7097.57	7097.81	10.14	1.16	3.17	1165.50	7097.98	7097.82	8.65	0.92	3.58	1157.82
	7346	2600	7094.20	7097.31	7097.67	10.68	1.24	3.11	1183.78	7098.04	7097.67	8.05	0.83	3.84	1178.62
	7345	2600	7094.00	7097.48	7097.52	9.41	1.03	3.48	1166.90	7098.09	7097.53	7.58	0.76	4.09	1207.68
	7344	2600	7093.80	7097.12	7097.37	10.24	1.16	3.32	1183.37	7098.12	7097.38	7.18	0.71	4.32	1242.90
	7343	2600	7093.60	7096.86	7097.23	10.78	1.23	3.25	1201.65	7098.15	7097.23	6.84	0.66	4.55	1283.53
	7342	2600	7093.40	7097.03	7097.07	9.52	1.03	3.63	1185.01	7098.17	7097.07	6.54	0.61	4.77	1328.30
	7341	2600	7093.20	7096.67	7096.93	10.35	1.15	3.47	1201.32	7098.19	7096.93	6.27	0.58	4.99	1376.75
	7340	2600	7093.00	7096.40	7096.77	10.89	1.23	3.40	1219.05	7098.21	7096.78	6.03	0.55	5.21	1429.02
	7339	2600	7092.80	7096.57	7096.62	9.65	1.04	3.77	1202.93	7098.22	7096.63	5.82	0.52	5.42	1483.67
	7338	2600	7092.60	7096.20	7096.47	10.49	1.16	3.60	1219.34	7098.24	7096.48	5.62	0.49	5.64	1542.41
	7337	2600	7092.40	7096.32	7096.32	9.52	1.01	3.92	1213.62	7098.25	7096.32	5.43	0.47	5.85	1603.32
	7336	2600	7092.20	7095.92	7096.17	10.46	1.14	3.72	1228.56	7098.26	7096.17	5.27	0.45	6.06	1666.79
	7335	2600	7092.00	7095.64	7096.02	11.04	1.22	3.64	1246.66	7098.27	7096.02	5.11	0.43	6.27	1733.43
	7334	2600	7091.80	7095.81	7095.86	9.81	1.03	4.01	1230.89	7098.28	7095.86	4.96	0.41	6.48	1802.53
	7333	2600	7091.60	7095.44	7095.72	10.65	1.15	3.84	1246.72	7098.29	7095.71	4.83	0.39	6.69	1872.97
	7332	2600	7091.40	7095.17	7095.56	11.19	1.23	3.77	1263.96	7098.29	7095.56	4.70	0.38	6.89	1946.54
	7331	2600	7091.20	7095.34	7095.41	9.96	1.04	4.14	1247.38	7098.30	7095.41	4.58	0.36	7.10	2021.13
Drop Toe	7330	2600	7091.00	7094.98	7095.25	10.79	1.16	3.98	1263.40	7098.31	7095.25	4.47	0.35	7.31	2098.36
	7329	2600	7091.00	7094.96	7095.25	10.85	1.17	3.96	1264.56	7098.30	7095.26	4.47	0.35	7.30	2098.11
	7328	2600	7091.00	7094.94	7095.25	10.92	1.18	3.94	1265.58	7098.30	7095.25	4.46	0.35	7.30	2098.21
	7327	2600	7091.00	7094.93	7095.25	10.94	1.18	3.93	1265.97	7098.30	7095.25	4.46	0.35	7.30	2097.58

Jump begins at Sta. 73+45 which is on the drop face, 15' upstream of the drop toe (Sta. 73+30). Calculate minimum drop basin length starting from drop toe:

Hydraulic Jump Length, Figure 15-4 (Chow)

$$F_1 = 1.24 \quad L/Y_2 = 3.5$$

$$Y_2 \text{ (ft)} = 7.31 \quad L \text{ (ft)} = 25.59$$

$$60\%L \text{ (ft)} = 15.35$$

(Minimum required length from toe for protection, minimum Basin Length) = **15.4'** **use 20'**

- Froude No. at beginning of hydraulic jump
- Specific Force (cu ft) at beginning of hydraulic jump (at location where Specific Force (subcritical) > Specific Force (supercritical))
- Maximum Channel Depth (ft) at approximate downstream end of hydraulic jump

Briargate Bridge at Sand Creek
Hydraulic Jump and Basin Length Calculations

4' Drop Structure B (Crest Station 72+55)

Hec Ras Mixed Flow Analysis (10-year)		Supercritical Analysis							Subcritical Analysis						
River Sta	Q Total	Min Ch El	W.S. Elev	Crit W.S.	Vel Chnl	Froude # Chl	Max Chl Dpth	Specif Force	W.S. Elev	Crit W.S.	Vel Chnl	Froude # Chl	Max Chl Dpth	Specif Force	
	(cfs)	(ft)	(ft)	(ft)	(ft/s)		(ft)	(cu ft)	(ft)	(ft)	(ft/s)		(ft)	(cu ft)	
Drop Crest	7255	1200	7093.00	7094.98	7094.98	7.56	1.00	1.98	430.85	7094.97	7094.97	7.57	1.01	1.97	430.86
	7254	1200	7092.80	7094.62	7094.82	8.55	1.19	1.82	438.99	7094.82	7094.82	7.60	1.00	2.02	433.33
	7253	1200	7092.60	7094.36	7094.66	9.15	1.30	1.76	448.88	7094.66	7094.66	7.66	1.01	2.06	436.01
Jump Begins	7252	1200	7092.40	7094.14	7094.50	9.59	1.38	1.74	458.36	7094.51	7094.51	7.68	1.00	2.11	438.76
	7251	1200	7092.20	7094.35	7094.35	7.70	1.00	2.15	441.66	7094.39	7094.35	7.57	0.98	2.19	441.77
	7250	1200	7092.00	7093.99	7094.20	8.72	1.19	1.99	450.43	7094.46	7094.20	6.79	0.83	2.46	451.73
	7249	1200	7091.80	7093.73	7094.04	9.32	1.29	1.93	460.78	7094.50	7094.04	6.23	0.73	2.70	468.85
	7248	1200	7091.60	7093.50	7093.88	9.80	1.38	1.90	471.20	7094.53	7093.89	5.80	0.66	2.93	490.68
	7247	1200	7091.40	7093.73	7093.73	7.88	1.01	2.33	454.37	7094.55	7093.73	5.44	0.60	3.15	516.22
	7246	1200	7091.20	7093.36	7093.57	8.89	1.18	2.16	463.35	7094.57	7093.57	5.13	0.55	3.37	544.91
	7245	1200	7091.00	7093.10	7093.42	9.47	1.28	2.10	473.72	7094.58	7093.42	4.88	0.51	3.58	575.78
	7244	1200	7090.80	7093.26	7093.26	8.01	1.01	2.46	464.66	7094.60	7093.27	4.64	0.47	3.80	609.70
	7243	1200	7090.60	7092.90	7093.11	9.01	1.18	2.29	473.81	7094.61	7093.11	4.44	0.44	4.01	645.31
	7242	1200	7090.40	7092.64	7092.95	9.58	1.27	2.24	483.78	7094.62	7092.96	4.26	0.42	4.22	683.08
	7241	1200	7090.20	7092.80	7092.80	8.13	1.00	2.60	475.60	7094.62	7092.80	4.10	0.39	4.42	721.84
	7240	1200	7090.00	7092.43	7092.65	9.14	1.17	2.43	484.70	7094.63	7092.65	3.96	0.37	4.63	762.36
	7239	1200	7089.80	7092.17	7092.49	9.73	1.26	2.37	494.89	7094.64	7092.50	3.82	0.35	4.84	804.61
	7238	1200	7089.60	7092.34	7092.34	8.29	1.01	2.74	486.94	7094.64	7092.34	3.70	0.34	5.04	846.99
	7237	1200	7089.40	7091.96	7092.18	9.30	1.17	2.56	495.95	7094.65	7092.19	3.59	0.32	5.25	891.70
	7236	1200	7089.20	7091.69	7092.03	9.94	1.26	2.48	506.56	7094.65	7092.03	3.49	0.31	5.45	936.76
	7235	1200	7089.00	7091.88	7091.88	8.43	1.00	2.88	498.25	7094.65	7091.88	3.40	0.30	5.65	982.83
	7234	1200	7088.80	7091.51	7091.72	9.40	1.15	2.71	506.42	7094.66	7091.72	3.31	0.29	5.86	1029.37
	7233	1200	7088.60	7091.23	7091.57	10.03	1.24	2.63	516.38	7094.66	7091.57	3.23	0.28	6.06	1076.65
	7232	1200	7088.40	7091.41	7091.41	8.64	1.01	3.01	509.33	7094.66	7091.42	3.16	0.27	6.26	1125.33
	7231	1200	7088.20	7091.04	7091.26	9.58	1.14	2.84	517.30	7094.66	7091.26	3.09	0.26	6.46	1173.67
	7230	1200	7088.00	7090.77	7091.11	10.20	1.23	2.76	527.06	7094.66	7091.11	3.02	0.25	6.66	1222.33
	7229	1200	7087.80	7090.92	7090.96	8.93	1.02	3.12	520.52	7094.67	7090.96	2.96	0.24	6.87	1271.51
	7228	1200	7087.60	7090.57	7090.81	9.79	1.15	2.97	528.58	7094.67	7090.81	2.91	0.24	7.07	1320.91
	7227	1200	7087.40	7090.31	7090.65	10.35	1.22	2.91	537.54	7094.67	7090.66	2.85	0.23	7.27	1371.09
	7226	1200	7087.20	7090.48	7090.51	9.09	1.02	3.28	531.54	7094.67	7090.51	2.81	0.22	7.47	1419.63
7225	1200	7087.00	7090.14	7090.36	9.93	1.14	3.13	539.29	7094.67	7090.36	2.76	0.22	7.67	1469.72	
7224	1200	7087.00	7090.13	7090.36	9.94	1.14	3.13	539.41	7094.67	7090.36	2.76	0.22	7.67	1468.88	
7223	1200	7087.00	7090.13	7090.37	9.96	1.14	3.13	539.54	7094.67	7090.36	2.76	0.22	7.67	1468.50	
7222	1200	7087.00	7090.13	7090.36	9.97	1.14	3.13	539.61	7094.67	7090.37	2.76	0.22	7.67	1468.44	

Jump begins at Sta. 72+51 which is on the drop face, 26' upstream of the drop toe (Sta. 72+25). Calculate minimum drop basin length starting from drop toe:

Hydraulic Jump Length, Figure 15-4 (Chow)

$$F_1 = 1.38 \quad L/Y_2 = 3.5$$

$$Y_2 \text{ (ft)} = 7.67 \quad L \text{ (ft)} = 26.85$$

$$60\%L \text{ (ft)} = 16.11$$

(Minimum required length from toe for protection, minimum Basin Length) = **16.1'** **use 20'**

- Froude No. at beginning of hydraulic jump
- Specific Force (cu ft) at beginning of hydraulic jump (at location where Specific Force (subcritical) > Specific Force (supercritical))
- Maximum Channel Depth (ft) at approximate downstream end of hydraulic jump

Briargate Bridge at Sand Creek Hydraulic Jump and Basin Length Calculations

Hydraulic jump locations were calculated using criteria from the Urban Storm Drainage Criteria Manual Vol. II, Hydraulic Structures section 2.3.4
 Hydraulic jump lengths were calculated using criteria from the Urban Storm Drainage Criteria Manual Vol. II, Hydraulic Structures section 2.3.5
 and from Open Channel Hydraulics by Ven Te Chow
 HEC-RAS was used for the frontwater (supercritical profile analysis) and for the backwater (subcritical profile analysis)

To determine the location of the hydraulic jump, a tailwater elevation has to be established by water surface profile analysis that starts from a downstream control point and works upstream to the drop basin. This backwater analysis is based upon entire cross sections for the downstream waterway. The hydraulic jump, in either the low-flow, trickle channel, or the main drop, will begin to form where the unit specific force of the downstream tailwater is greater than the specific force of the supercritical flow below the drop. Special consideration must be given to submerged hydraulic jumps because it is here that reverse rollers are most common. For submerged jumps, the resulting downstream hydraulics should be evaluated (Cotton 1995).

The determination of the jump location is usually accomplished through the comparison of specific force between supercritical inflow and the downstream subcritical flow (i.e., tailwater) conditions:

$$F = \left(\frac{q^2}{gV} \right) + \left(\frac{y^2}{2} \right) \quad (\text{HS-6})$$

in which:

F = specific force (ft²)

q = unit discharge (determined at crest, for low-flow, trickle, and main channel zones) (cfs/ft)

y = depth at analysis point (ft)

g = acceleration of gravity = 32.2 ft/sec²

The depth, y , for downstream specific energy determination is the tailwater water surface elevation minus the ground elevation at the point of interest, which is typically the main basin elevation or the trickle channel invert (if the jump is to occur in the basin). The depth, for the upstream specific energy (supercritical flow), is the supercritical flow depth at the point in question.

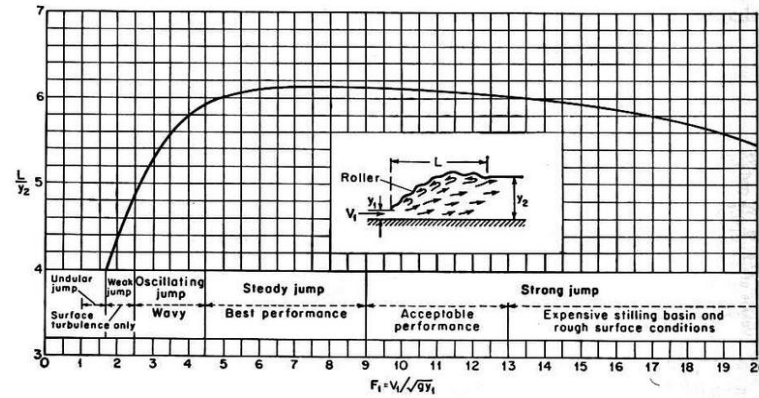

FIG. 15-4. Length in terms of sequent depth y_2 of jumps in horizontal channels. (Based on data and recommendations of U.S. Bureau of Reclamation [34].)

Figure 15-4 (Chow), Used to determine the length of the hydraulic jump

Briargate Bridge at Sand Creek
Seepage Analysis and Cutoff Wall Calculations

Seepage Analysis (Lane's Weighted Creep Method Calculation)

Location	C _w	Weep Drain System	C _w	H _s	Drop Height				L _H	Required L _{v-calc}	L _{v-Struct}	L _v Difference L _{v-calc} and L _{v-Struct}	Additional Calculated Cut off Wall Depth	Additional Cut off Wall Depth
						L _a	L _f	L _s						
Sta. 73+70	1.6	Yes	1.4	4.5 ft	4.0 ft	10.0ft	30.0ft	20.0ft	60.0 ft	-13.5 ft	7.0 ft	0.0 ft	0.0 ft	0 ft
Sta. 72+65	1.6	Yes	1.4	3.3 ft	4.0 ft	10.0ft	30.0ft	20.0ft	60.0 ft	-15.2 ft	7.0 ft	0.0 ft	0.0 ft	0 ft

Equations:

$$C_w = [(L_H/3) + L_v] / H_s \text{ (USDCM Eqn 9-5)}$$

C_w = Lane's Weighted Creep Ratio

Table 9-3: Lane's Weighted Creep Recommended Ratios (USDCM)

C_w = 8.5 Very fine sand or silt

C_w = 7.0 Fine Sand

C_w = 6.0 Medium Sand

C_w = 5.0 Coarse Sand

C_w = 4.0 Fine Gravel

C_w = 3.0 Coarse gravel including cobbles or Soft Clay

C_w = 2.0 Medium Clay

C_w = 1.8 Hard Clay

C_w = 1.6 Very Hard Clay or hardpan

Weep Drain System: 10% Reduction in C_w if weep drain system is used

H_s = Head Differential between analysis points -- Taken from HEC-Ras

Drop Height = Difference between Crest and Sill

L_H = Sum of the Horizontal Creep Distances (Less than 45 degrees)

$$L_H = L_a + L_f + L_s$$

L_a = Approach Length

L_s = Length of stilling basin (Toe to Sill)

L_f = Drop Face Length (Crest to Toe)

L_v = Sum of the Vertical Creep Distances (Steeper than 45 degrees)

L_{v-Struct} = Vertical creep distances of structure w/o cut off wall

Additional Calculated Cutoff Wall Depth = Half of L_v Difference if Sheet Pile

2.3.7 Evaluate Additional Return Period Flow Rates

Evaluate the design flow and then assess additional return-period flow rates, as appropriate. For all flows, the actual downstream tailwater should be greater than the tailwater required to force a hydraulic jump to start near the toe of the drop structure face. When this condition is met for a range of events a stilling basin length of 60% of the hydraulic jump length should be adequate.

2.3.8 Rock Sizing for Drop Approach and Downstream of End Sill

Calculate the appropriate rock size for the drop approach and downstream of the end sill. The hydraulic conditions at the approach include the acceleration effects of the upstream drawdown as the water approaches the drop crest. Turbulence generated from the hydraulic jump will impact the area downstream of the end sill. Determine riprap size using the equations provided in the *Open Channels* chapter for channel lining. Because normal depth conditions do not exist upstream and downstream of the drop structure, refer to the HEC-RAS output and use the energy grade line slope (rather than channel slope) to determine the appropriate riprap size.

Riprap at the approach and downstream of the end sill should be a minimum D_{50} of 12-inches, or larger as determined using the channel lining equation in the *Open Channels* chapter. Use either void-filled or soil-filled riprap in these areas.

2.4 Seepage Control

2.4.1 Introduction

Subgrade erosion caused by seepage and structure failures caused by high seepage pressures or inadequate mass are two failure modes of critical concern.

Seepage analyses can range from hand-drawn flow nets to computerized groundwater flow modeling. Use advanced geotechnical field and laboratory testing techniques confirm permeability values where complicated seepage problems are anticipated. Several flow net analysis programs are currently available that are suitable for this purpose. Full description of flow net analysis is beyond the scope of the Urban Storm Drainage Criteria Manual (USDCM). Referred to Cedergren 1967; USBR 1987; and Taylor 1967 for more information and instruction in the use of flow net analysis techniques. See Section 2.4.3 for Lane's Weighted Creep method, a simplified approach.

2.4.2 Weep Drains

Install weep drains in all grade control structures greater than 5 feet in net height or as recommended by the geotechnical engineer. Weep drains assist in reducing the uplift pressure on a structure by providing a location for groundwater to escape safely through a filter. For concept, see Figure 9-10. Weep drains should be placed outside of the low-flow path of the structure and spaced to provide adequate relief of subsurface pressures.

2.4.3 Lane's Weighted Creep Method

As a minimum level of analysis and as a first order of estimation, Lane's Weighted Creep (Lane's) Method can be used to identify probable seepage problems, evaluate the need for control measures, and estimate rough uplift forces. It is not as definitive as the flow net analyses mentioned above. Lane's method was proposed by E.W. Lane in 1935. This method was removed from the 1987 revision of *Design of Small Dams* (USBR 1987), possibly indicating greater use of flow net and computer modeling

methods or perhaps for other reasons not documented. Although Lane's method is relatively well founded, it is a guideline, and when marginal conditions or complicated geological conditions exist, use the more sophisticated flow-net analysis.

The essential elements of Lane's method are as follows:

1. The weighted-creep distance through a cross section of a structure is the sum of the vertical creep distances, L_v (along contact surfaces steeper than 45 degrees), plus one-third of the horizontal creep distances, L_H (along contact surfaces less than 45 degrees).
2. The weighted-creep head ratio is defined as:

$$C_w = \frac{\left(\frac{L_H}{3} + L_v\right)}{H_s} \quad \text{Equation 9-5}$$

Where:

C_w = creep ratio

H_s = differential head between analysis points (ft)

3. Reverse filter drains, weep holes, and pipe drains help to reduce seepage problems, and recommended creep head ratios may be reduced as much as 10% if they are used.
4. In the case where two vertical cutoffs are used, then Equation 9-6 should be used along with Equation 9-2 to check the short path between the bottom of the vertical cutoffs.

$$C_{w2} = \frac{(L_{v-US} + 2L_{H-C} + L_{v-DS})}{H_s} \quad \text{Equation 9-6}$$

Where:

C_{w2} = creep ratio where two vertical cutoffs are used

L_{v-US} = vertical distance on the upstream side of the upstream cutoff (ft)

L_{v-DS} = vertical distance on the downstream side of the downstream cutoff (ft)

L_{H-C} = horizontal distance between the two vertical cutoffs (ft)

5. If there are seepage lengths upstream or downstream of the cutoffs, they should be treated in the numerator of Equation 9-6 similar to Equation 9-5. Seepage is controlled by increasing the total seepage length such that C_w or C_{w2} is raised to the value listed in Table 9-3. Test soils during design and again during construction.
6. Estimate the upward pressure in design by assuming that the drop in uplift pressure from headwater to tailwater along the contact line of the drop structure is proportional to the weighted-creep distance.

Table 9-3. Lane's weighted creep: Recommended minimum ratios

Material	Ratio
Very fine sand or silt	8.5
Fine sand	7.0
Medium sand	6.0
Coarse sand	5.0
Fine gravel	4.0
Medium gravel	3.0
Coarse gravel including cobbles	3.0
Boulders with some cobbles and gravel	3.0
Soft clay	3.0
Medium clay	2.0
Hard clay	1.8
Very hard clay or hardpan	1.6

2.4.4 Foundation/Seepage Control Systems

As a general rule, groundwater flow cutoffs should not be installed at the downstream ends of drop structures. They can cause greater hydraulic uplift forces than would exist without a downstream cutoff. The design goal is to relieve the hydrostatic pressures along the structure and not to block the groundwater flow and cause higher pressures to build up.

The hydraulic engineer must calculate hydraulic loadings that can occur for a variety of conditions such as dominant low flows, flood flows, design flows and other critical loading scenarios. A geotechnical engineer should combine this information with the on-site soils information to determine foundation requirements. Both engineers should work with a structural engineer to establish final loading diagrams and to determine and size structural components.

The designer needs to be cognizant of field conditions that may affect construction of a drop structure, including site water control and foundation moisture and compaction. A common problem is destabilization of the foundation soils by rapid local dewatering of fine-grained, erosive soils or soils with limited hydraulic conductivity. Since subsurface water control during construction is so critical to the successful installation of a drop structure, the designer needs to develop ways to ensure that the contractor adequately manages subsurface water conditions.

During construction, check design assumptions in the field including the actual subgrade condition with respect to seepage control assumptions be inspected and field verified. Ideally, the engineer who established the design assumptions and calculated the required cutoffs should inspect the cutoff for each drop structure and adjust the cutoff for the actual conditions encountered. For example, if the inspection of a cutoff trench reveals a sandy substrate rather than clay, the designer may choose to extend the cutoff trench, or specify a different cutoff type. Pre-construction soil testing is an advisable precaution to minimize changes and avoid failures.

Proper dewatering in construction will also improve conditions for construction structures. See Fact Sheet SM-08, Temporary Diversion Methods, located in Volume 3 of this manual.

**Briargate Bridge at Sand Creek
Riprap and Boulder Design Calculations**

Station	Description	Riprap or Boulder	Straight or Curved Section	Flow Velocity	Channel Slope	For Curved Sections			Velocity for Calc	Super-elevation dY	Rock Sizing Parameter	Calculated Riprap Type	Calculated Boulder Size	Riprap or Boulder Classification	Note
						rc	T	V _a							
73+80	Upstream of Upper Drop Crest	Riprap	Curve	8.1ft/sec	1.40%	500ft	112ft	12.3ft/sec	12.3ft/sec	0.23ft	4.5	M	---	M	1
73+10	Downstream of Upper Drop Sill	Riprap	Curve	5.5ft/sec	0.20%	500ft	116ft	8.5ft/sec	8.5ft/sec	0.11ft	2.2	VL	---	M	2
72+75	Upstream of Lower Drop Crest	Riprap	Curve	5.9ft/sec	0.20%	500ft	113ft	9.0ft/sec	9.0ft/sec	0.12ft	2.3	VL	---	M	1
72+05	Downstream of Lower Drop Sill	Riprap	Straight	5.9ft/sec	0.20%				5.9ft/sec		1.5	VL	---	M	2
69+34	Culvert Protection	Riprap	Straight	12.1ft/sec	0.20%				12.1ft/sec		3.2	VL	---	M	3
73+60	Upper Drop Structure	Boulder	Straight	10.1ft/sec	20.0%				10.1ft/sec		5.8	---	B30	B30	
72+55	Lower Drop Structure	Boulder	Straight	7.6ft/sec	20.0%				7.6ft/sec		4.3	---	B24	B24	

Equations:

$$\text{Rock Sizing Parameter} = VS^{0.17}/(G_s-1)^{0.66}$$

V = Mean channel flow velocity for Riprap Sizing

V = Critical Velocity for Grouted Boulder Sizing

S = Longitudinal channel slope

G_s = Specific Gravity of stone (minimum G_s = 2.50)

G_s = 2.55 (UDFCD Recommended) (2'x3' is about 1 ton, able to be moved by skid steer)

$$G_s = 2.55$$

Equations taken from UDFCD USDCM (Eqn MD-13 & HS-9) and City of Colorado Springs & El Paso County Drainage Criteria Manual

$$v_a = (-0.147 r_c/T + 2.176)V \text{ (Eqn UDFCD MD-10)}$$

V_a = Adjusted channel velocity for riprap sizing along outside of channel bends

r_c = channel centerline radius

T = Top width of water during the major design flood

$$\text{Superelevation (dY)} = V^2T/2gr_c \text{ (Eqn UDFCD MD-9)}$$

V = Mean channel flow velocity

T = Top Width of the channel under design flow conditions

g = Gravitational constant = 32.2 ft/sec²

r_c = channel centerline radius

- Notes:**
1. Type M Riprap is minimum size recommended for areas immediately upstream of drop structures (water surface drawdown area).
 2. Type M Riprap is minimum size recommended for areas immediately downstream of drop structures (hydraulic jump area).
 3. Type M Riprap is minimum size recommended for channel lining through and downstream of culvert.

Rock Sizing Parameter	Riprap Type	D50	
0.00	3.29	VL	6 inches
3.30	3.99	L	9 inches
4.00	4.59	M	12 inches
4.60	5.59	H	18 inches
5.60	6.40	VH	24 inches

Rock Sizing Parameter	Grouted Boulder Classification	Grouted Boulder Min. Dimension	
0.00	4.49	B18	18 inches
4.50	4.99	B18	18 inches
5.00	5.59	B24	24 inches
5.60	6.39	B30	30 inches
6.40	6.99	B36	36 inches
7.00	7.49	B42	42 inches
7.50	8.00	B48	48 inches

8.1 Riprap Sizing

Procedures for sizing rock to be used in soil riprap, void-filled riprap, and riprap over bedding are the same.

8.1.1 Mild Slope Conditions

When subcritical flow conditions occur and/or slopes are mild (less than 2 percent), UDFCD recommends the following equation (Hughes, et al, 1983):

$$d_{50} \geq \left[\frac{VS^{0.17}}{4.5(G_s - 1)^{0.66}} \right]^2 \quad \text{Equation 8-11}$$

Where:

V = mean channel velocity (ft/sec)

S = longitudinal channel slope (ft/ft)

d_{50} = mean rock size (ft)

G_s = specific gravity of stone (minimum = 2.50, typically 2.5 to 2.7), Note: In this equation ($G_s - 1$) considers the buoyancy of the water, in that the specific gravity of water is subtracted from the specific gravity of the rock.

Note that Equation 8-11 is applicable for sizing riprap for channel lining with a longitudinal slope of no more than 2%. This equation is not intended for use in sizing riprap for steep slopes (typically in excess of 2 percent), rundowns, or protection downstream of culverts. Information on rundowns is provided in Section 7.0 of the *Hydraulic Structures* chapter of the USDCM, and protection downstream of culverts is discussed in the *Culverts and Bridges* chapter. For channel slopes greater than 2% use one of the methods presented in 8.1.2.

Rock size does not need to be increased for steeper channel side slopes, provided the side slopes are no steeper than 2.5H:1V (UDFCD 1982). Channel side slopes steeper than 2.5H:1V are not recommended because of stability, safety, and maintenance considerations. See Figure 8-34 for riprap placement specifications. At the upstream and downstream termination of a riprap lining, the thickness should be increased 50% for at least 3 feet to prevent undercutting.

8.1.2 Steep Slope Conditions

Steep slope rock sizing equations are used for applications where the slope is greater than 2 percent and/or flows are in the supercritical flow regime. The following rock sizing equations may be referred to for riprap design analysis on steep slopes:

- CSU Equation, *Development of Riprap Design Criteria by Riprap Testing in Flumes: Phase II* (prepared by S.R. Abt, et al, Colorado State University, 1988). This method was developed for steep slopes from 2 to 20 percent.
- USDA- Agricultural Research Service Equations, *Design of Rock Chutes* (by K.M. Robinson, et al, USDA- ARS, 1998 Transactions of ASAE) and *An Excel Program to Design Rock Chutes for Grade*

**DESIGN OF ROADSIDE CHANNELS
WITH FLEXIBLE LININGS**

Hydraulic Engineering Circular No. 15

Prepared By

Simons, Li & Associates, Inc.
3555 Stanford Road
P.O. Box 1816
Fort Collins, Colorado 80522

For

U.S. Department of Transportation
Federal Highway Administration

October 25, 1985

Table 4.1. Permissible Shear Stresses for Lining Materials.

Lining Category	Lining Type	Permissible Unit Shear Stress (lb/ft ²)
Temporary	Woven Paper Net	0.15
	Jute Net	0.45
	Fiberglass Roving*	0.75
	Straw and Erosion Net	1.45 ← OB slope
	Curled Wood Mat (TRM)	1.55 ← bench
	Nylon Mat	2.00
Vegetative	Class A	3.70
	Class B	2.10 ← OB slope
	Class C	1.00
	Class D	0.60
	Class E	0.35
Gravel Riprap	1-inch	0.40
	2-inch	0.80
Rock Riprap	6-inch	2.50
	12-inch	5.00

* single and double applications

TABLE 3.1.--Classification of vegetal covers as to degree of retardance (6)

Note: Covers classified have been tested in experimental channels.
Covers were green and generally uniform.

Retardance	Cover	Condition
A	Weeping lovegrass	Excellent stand, tall, (average 30")
	Yellow bluestem <i>Ischaemum</i> ..	Excellent stand, tall, (average 36")
B	Kudzu	Very dense growth, uncut
	Bermudagrass	Good stand, tall (average 12")
	Native grass mixture (little bluestem, blue grama, and other long and short mid-west grasses)	Good stand, unmowed
	Weeping lovegrass	Good stand, tall, (average 24")
	Lespedeza sericea	Good stand, not woody, tall (average 19")
	Alfalfa	Good stand, uncut, (average 11")
	Weeping lovegrass	Good stand, mowed, (average 13")
	Kudzu	Dense growth, uncut
	Blue grama	Good stand, uncut, (average 13")
	C	Crabgrass
Bermudagrass		Good stand, mowed (average 6")
Common lespedeza		Good stand, uncut (average 11")
Grass-legume mixture--summer (orchard grass, redbot, Italian ryegrass, and common lespedeza)		Good stand, uncut (6 to 8 inches)
Centipedegrass		Very dense cover (average 6 inches)
Kentucky bluegrass		Good stand, headed (6 to 12 inches)
D	Bermudagrass	Good stand, cut to 2.5-inch height
	Common lespedeza	Excellent stand, uncut (average 4.5")
	Buffalograss	Good stand, uncut (3 to 6 inches)
	Grass-legume mixture--fall, spring (Orchardgrass, redbot, Italian ryegrass, and common lespedeza)	Good stand, uncut (4 to 5 inches)
E	Lespedeza sericea	After cutting to 2-inch height. Very good stand before cutting.
	Bermudagrass	Good stand, cut to 1.5 inches height
	Bermudagrass	Burned stubble.

Appendix D: HECRAS Hydraulic Modelling

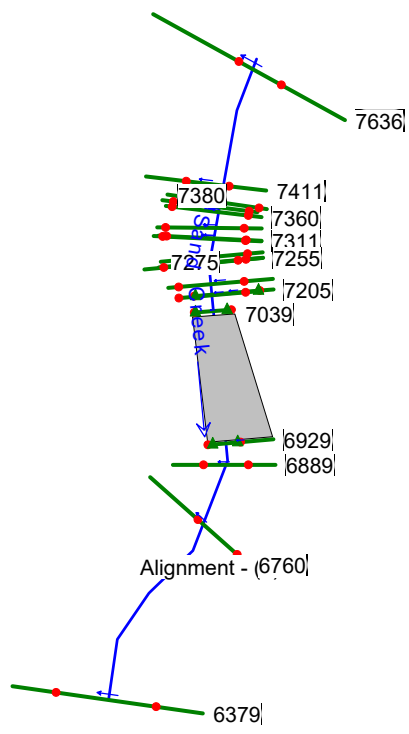

2021 Sand Creek at Briargate Pkwy Plan: Proposed Profiles 3/7/2022

Sand Creek Alignment - (1)

Legend	
WS 500yr	x
WS 100yr	▼
WS 50yr	▲
WS DP-69	■
WS 10yr	■
Ground	■

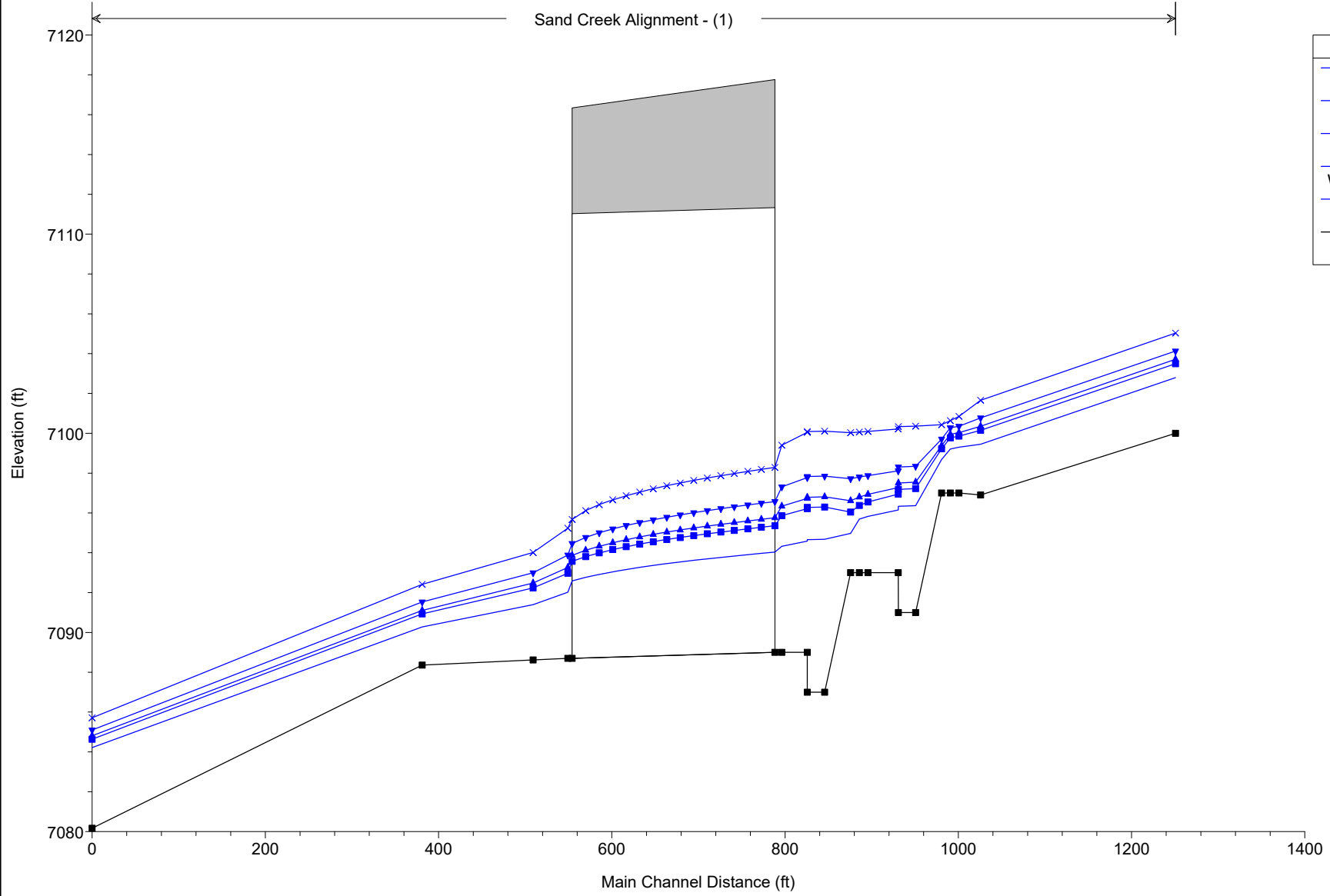

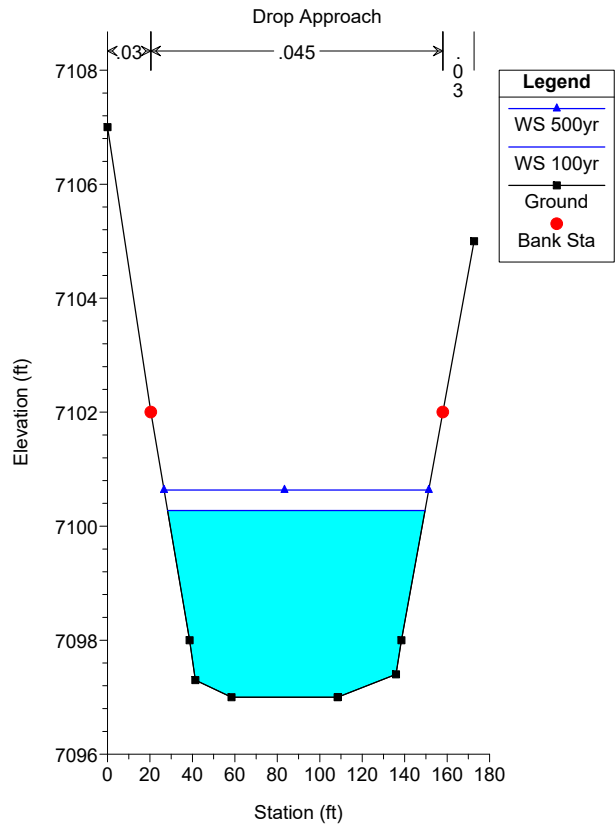
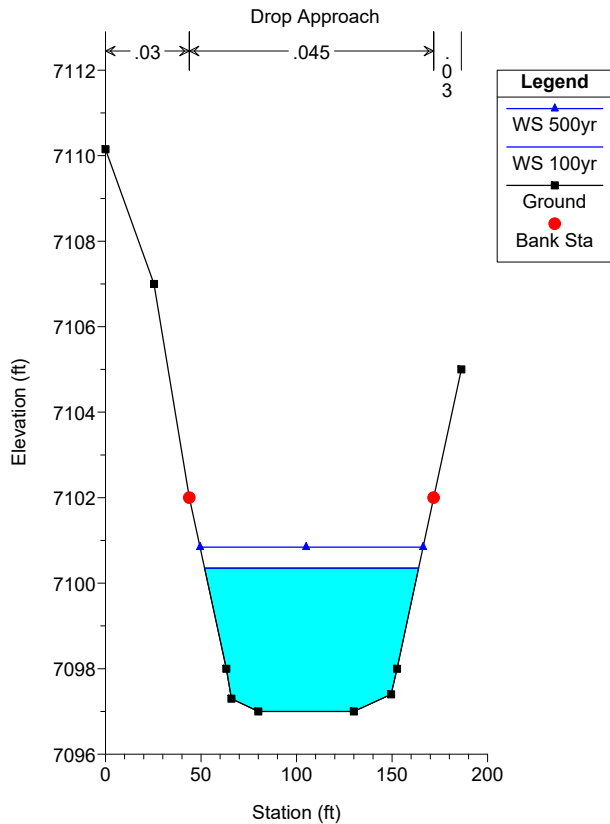
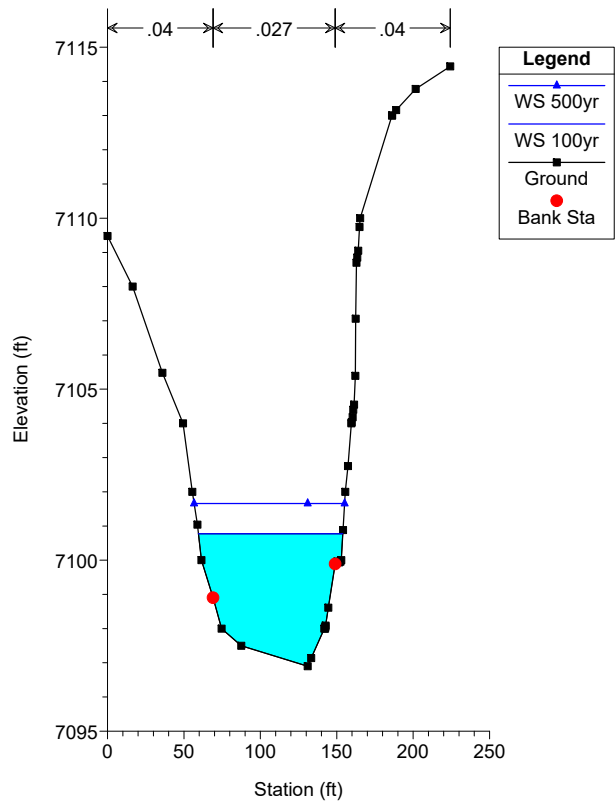
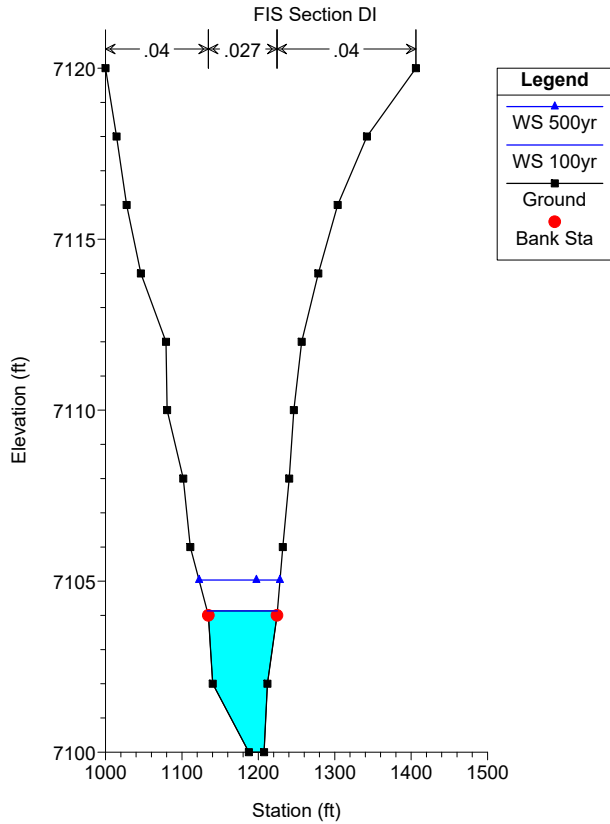

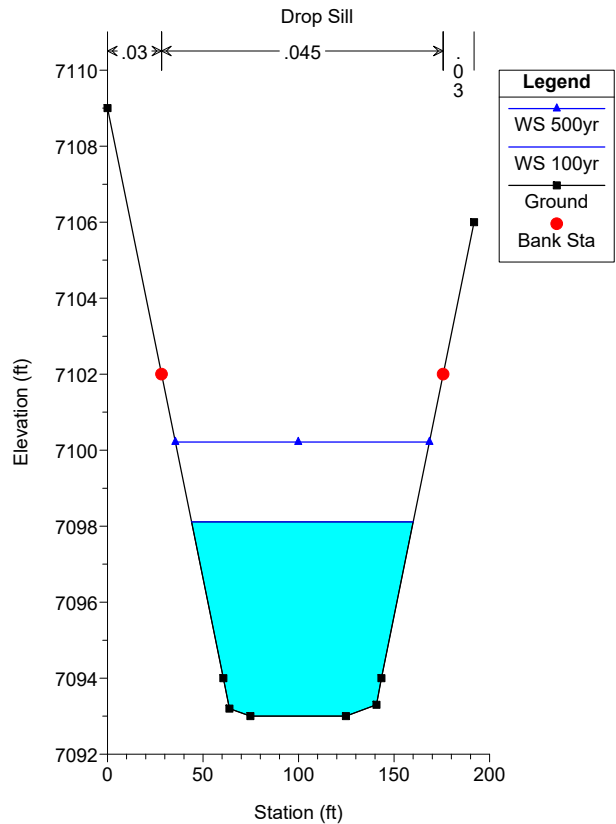
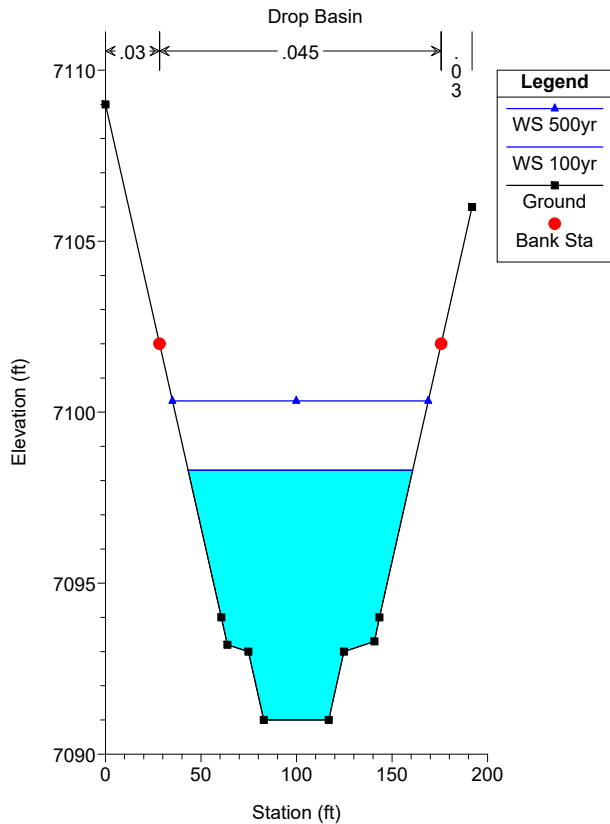
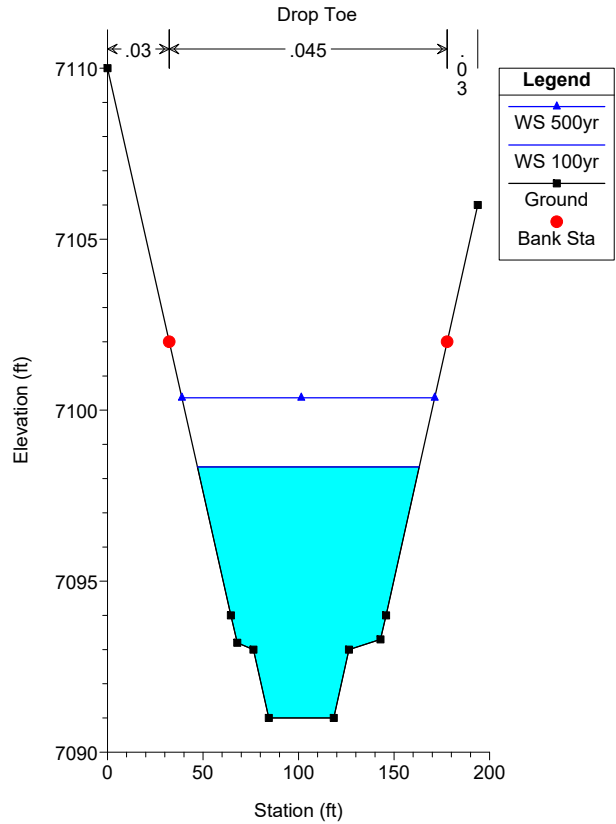
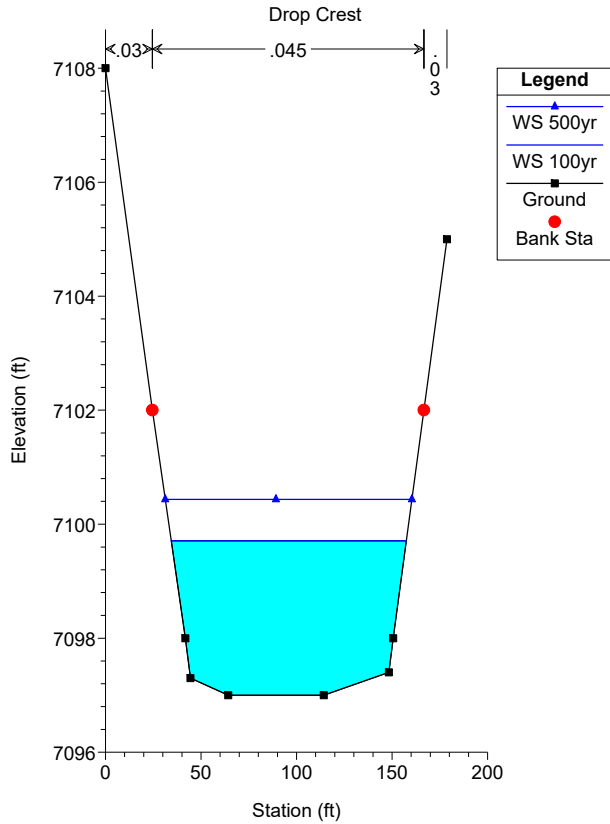

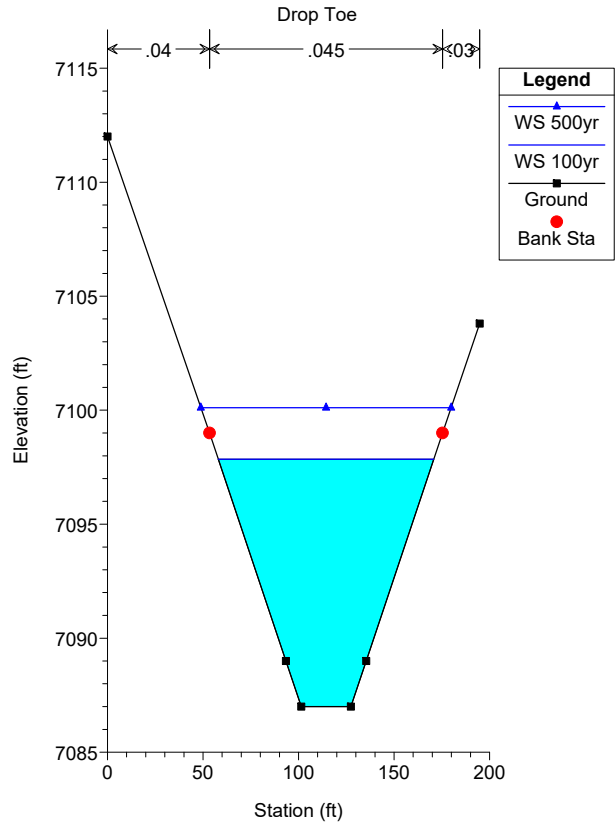
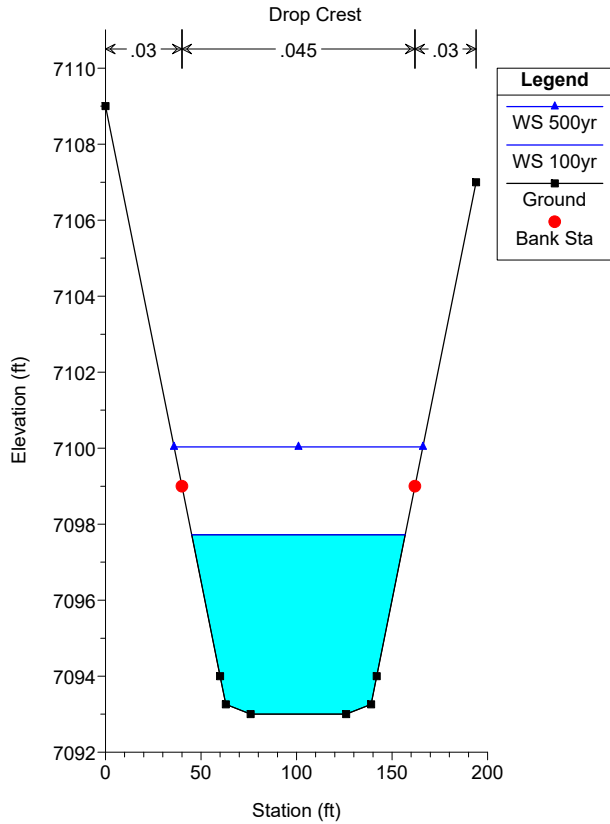
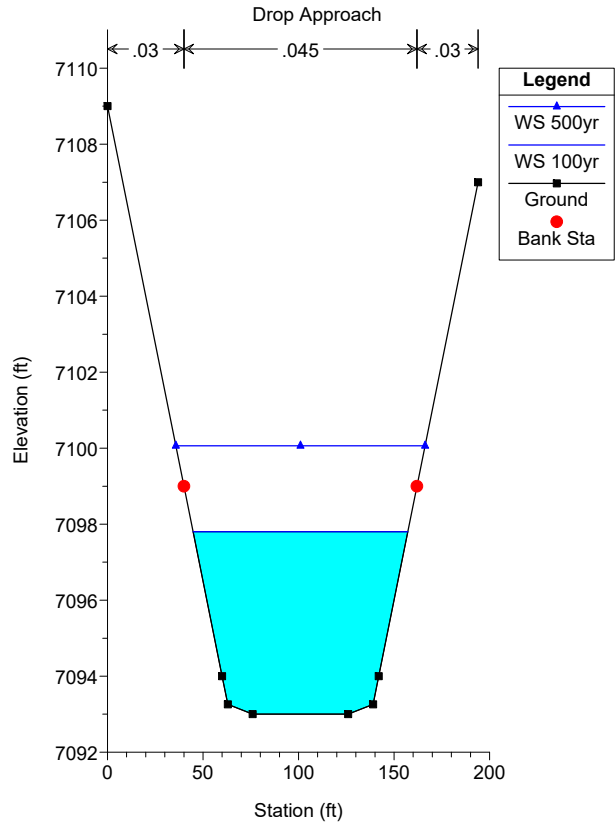
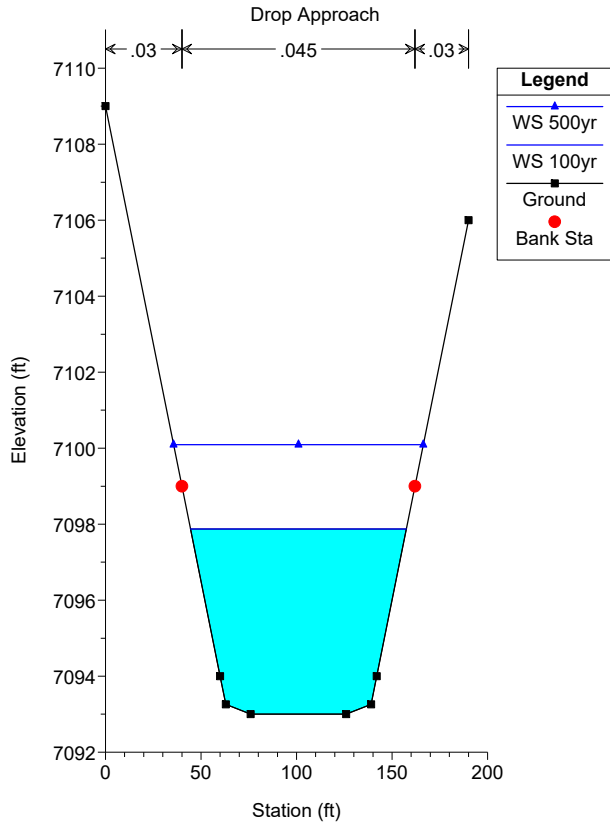

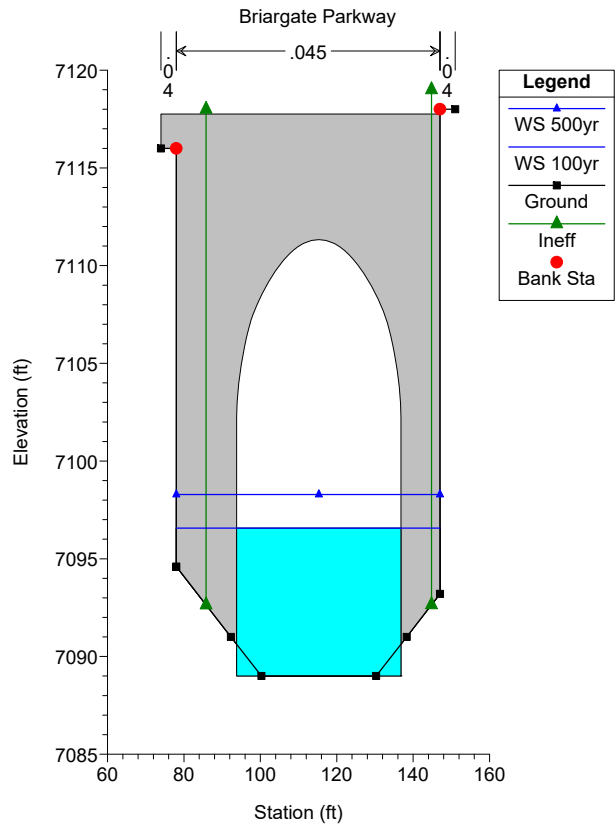
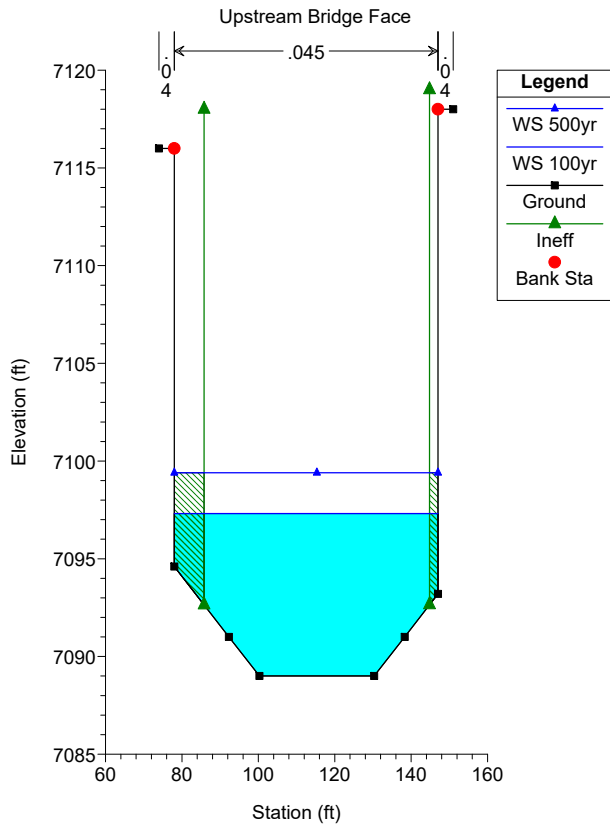
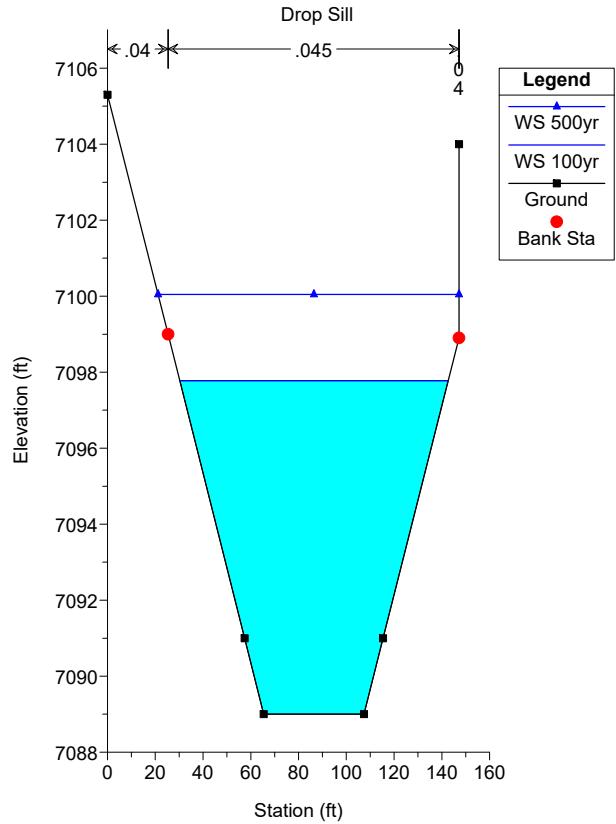
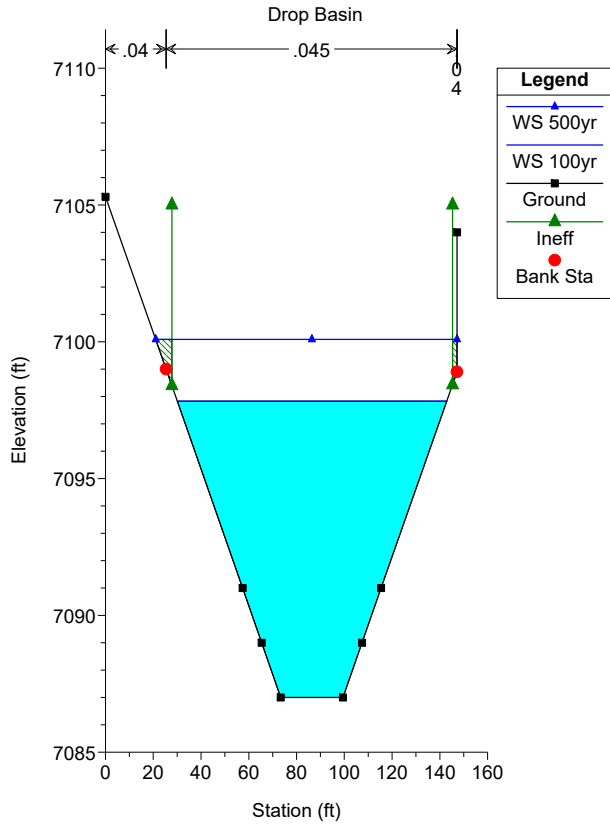

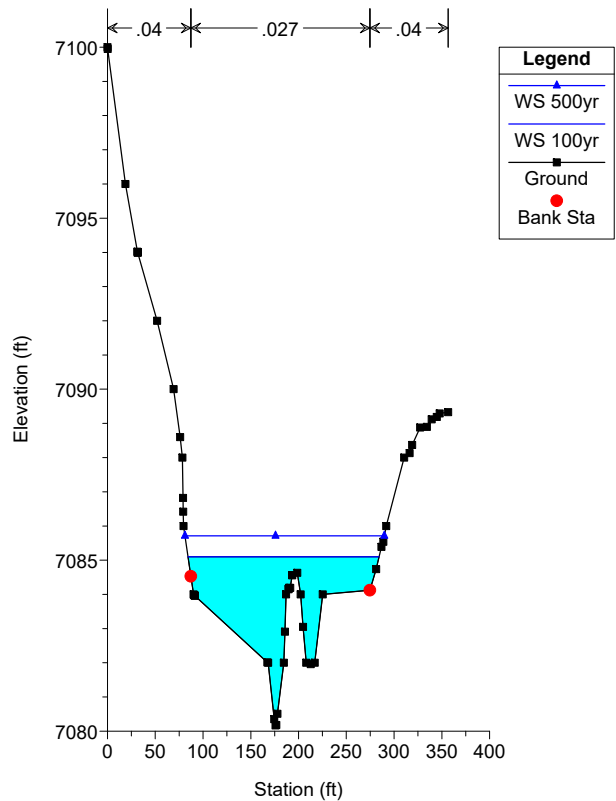
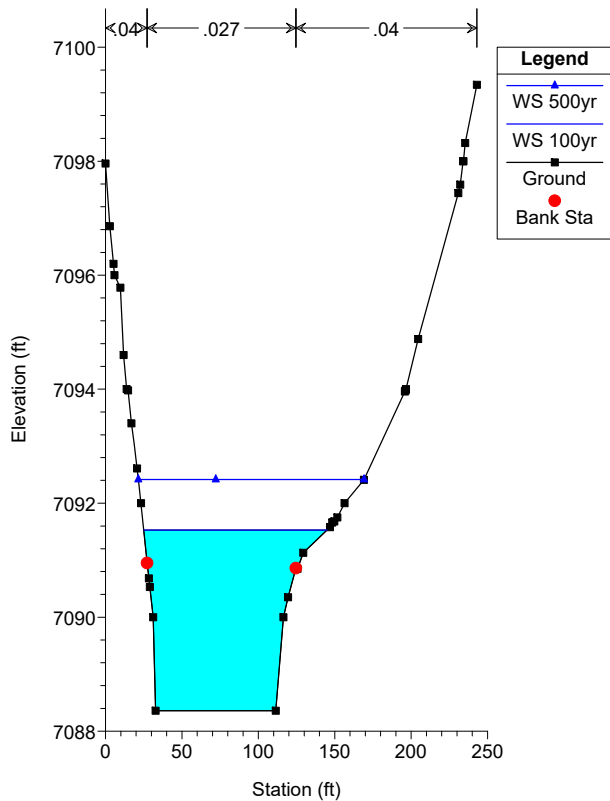
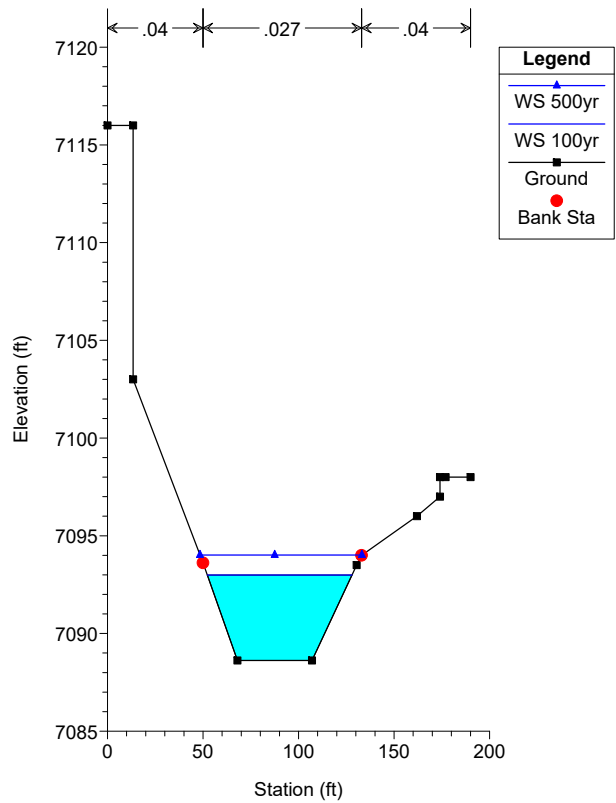
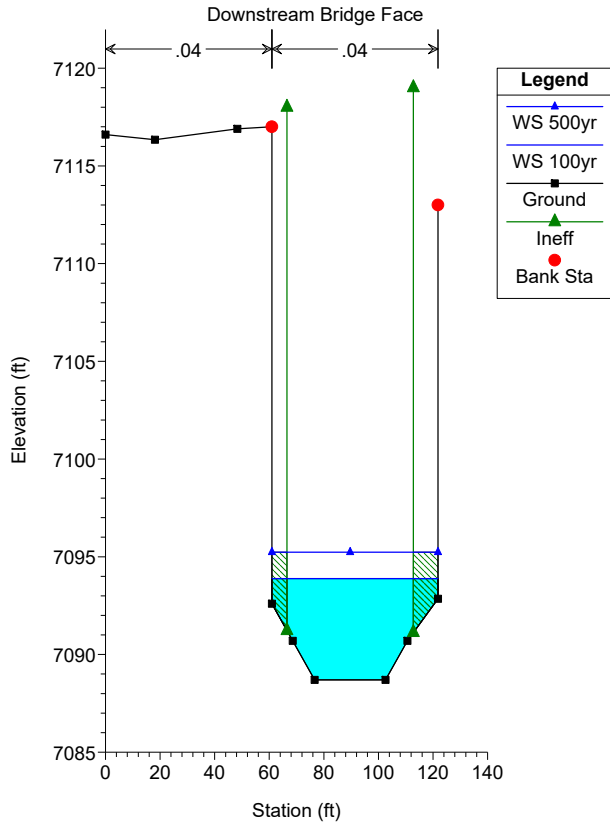

HEC-RAS Plan: Proposed Profiles River: Sand Creek Reach: Alignment - (1)

Reach	River Sta	Profile	Q Total (cfs)	Min Ch El (ft)	W.S. Elev (ft)	Crit W.S. (ft)	E.G. Elev (ft)	E.G. Slope (ft/ft)	Vel Chnl (ft/s)	Flow Area (sq ft)	Top Width (ft)	Froude # Chl
Alignment - (1)	7636	10yr	1200.00	7100.00	7102.80	7102.80	7103.77	0.008771	7.92	151.55	78.92	1.01
Alignment - (1)	7636	50yr	2100.00	7100.00	7103.72	7103.72	7105.04	0.007909	9.22	227.80	87.22	1.01
Alignment - (1)	7636	100yr	2600.00	7100.00	7104.13	7104.13	7105.63	0.007632	9.82	264.97	91.86	1.01
Alignment - (1)	7636	500yr	3800.00	7100.00	7105.03	7105.03	7106.89	0.006651	10.95	354.01	105.90	0.98
Alignment - (1)	7636	DP-69	1870.00	7100.00	7103.50	7103.50	7104.74	0.008128	8.96	208.77	85.23	1.01
Alignment - (1)	7411	10yr	1200.00	7096.90	7099.45	7099.45	7100.42	0.008643	7.91	152.47	82.17	1.00
Alignment - (1)	7411	50yr	2100.00	7096.90	7100.35	7100.35	7101.69	0.007333	9.31	231.83	92.84	0.98
Alignment - (1)	7411	100yr	2600.00	7096.90	7100.77	7100.77	7102.29	0.006934	9.95	271.39	94.46	0.98
Alignment - (1)	7411	500yr	3800.00	7096.90	7101.66	7101.66	7103.58	0.006428	11.26	356.48	98.50	0.98
Alignment - (1)	7411	DP-69	1870.00	7096.90	7100.15	7100.15	7101.39	0.007502	8.96	213.28	92.06	0.98
Alignment - (1)	7380	10yr	1200.00	7097.00	7099.30	7099.30	7099.84	0.012624	5.88	204.14	101.94	0.73
Alignment - (1)	7380	50yr	2100.00	7097.00	7100.03	7100.03	7100.90	0.014565	7.47	281.13	108.97	0.82
Alignment - (1)	7380	100yr	2600.00	7097.00	7100.35	7100.06	7101.40	0.015623	8.22	316.47	112.05	0.86
Alignment - (1)	7380	500yr	3800.00	7097.00	7100.85	7100.85	7102.46	0.020457	10.20	372.73	116.78	1.01
Alignment - (1)	7380	DP-69	1870.00	7097.00	7099.86	7099.86	7100.65	0.014279	7.13	262.12	107.28	0.80
Alignment - (1)	7370	10yr	1200.00	7097.00	7099.21	7098.77	7099.69	0.011779	5.56	215.80	111.23	0.70
Alignment - (1)	7370	50yr	2100.00	7097.00	7099.95	7099.50	7100.71	0.012949	6.98	300.84	118.23	0.77
Alignment - (1)	7370	100yr	2600.00	7097.00	7100.28	7099.86	7101.19	0.013689	7.65	339.84	121.31	0.81
Alignment - (1)	7370	500yr	3800.00	7097.00	7100.64	7100.62	7102.16	0.020203	9.90	383.99	124.70	0.99
Alignment - (1)	7370	DP-69	1870.00	7097.00	7099.77	7099.33	7100.47	0.012845	6.69	279.63	116.53	0.76
Alignment - (1)	7360	10yr	1200.00	7097.00	7098.68	7098.68	7099.44	0.026110	6.98	171.88	114.50	1.00
Alignment - (1)	7360	50yr	2100.00	7097.00	7099.38	7099.38	7100.44	0.023356	8.28	253.74	120.32	1.00
Alignment - (1)	7360	100yr	2600.00	7097.00	7099.71	7099.71	7100.93	0.022639	8.85	293.86	123.07	1.01
Alignment - (1)	7360	500yr	3800.00	7097.00	7100.43	7100.43	7101.95	0.020939	9.86	385.23	129.12	1.01
Alignment - (1)	7360	DP-69	1870.00	7097.00	7099.22	7099.22	7100.21	0.023715	7.97	234.52	118.98	1.00
Alignment - (1)	7330	10yr	1200.00	7091.00	7096.37	7096.37	7096.53	0.001677	3.22	372.79	100.23	0.29
Alignment - (1)	7330	50yr	2100.00	7091.00	7097.55	7097.55	7097.83	0.002231	4.23	496.68	109.72	0.35
Alignment - (1)	7330	100yr	2600.00	7091.00	7098.34	7098.34	7098.65	0.002121	4.43	586.49	116.11	0.35
Alignment - (1)	7330	500yr	3800.00	7091.00	7100.36	7100.36	7100.68	0.001651	4.54	837.18	132.33	0.32
Alignment - (1)	7330	DP-69	1870.00	7091.00	7097.22	7097.22	7097.48	0.002190	4.05	461.27	107.09	0.34
Alignment - (1)	7311	10yr	1200.00	7091.00	7096.34	7096.34	7096.49	0.001674	3.20	375.04	101.65	0.29
Alignment - (1)	7311	50yr	2100.00	7091.00	7097.50	7097.50	7097.78	0.002226	4.20	499.44	111.10	0.35
Alignment - (1)	7311	100yr	2600.00	7091.00	7098.30	7098.30	7098.60	0.002104	4.40	590.76	117.55	0.35
Alignment - (1)	7311	500yr	3800.00	7091.00	7100.33	7100.33	7100.65	0.001621	4.49	845.86	133.93	0.32
Alignment - (1)	7311	DP-69	1870.00	7091.00	7097.18	7097.18	7097.43	0.002190	4.03	463.63	108.46	0.34
Alignment - (1)	7310	10yr	1200.00	7093.00	7096.15	7096.15	7096.45	0.004738	4.41	272.32	100.16	0.47
Alignment - (1)	7310	50yr	2100.00	7093.00	7097.28	7097.28	7097.73	0.004922	5.38	390.26	109.25	0.50
Alignment - (1)	7310	100yr	2600.00	7093.00	7098.11	7098.11	7098.56	0.003983	5.37	484.41	116.00	0.46
Alignment - (1)	7310	500yr	3800.00	7093.00	7100.22	7100.22	7100.62	0.002425	5.09	746.35	132.99	0.38
Alignment - (1)	7310	DP-69	1870.00	7093.00	7096.94	7096.94	7097.38	0.005202	5.28	354.43	106.57	0.51
Alignment - (1)	7275	10yr	1200.00	7093.00	7095.83	7095.83	7096.22	0.007063	5.04	238.07	96.62	0.57
Alignment - (1)	7275	50yr	2100.00	7093.00	7096.93	7096.93	7097.49	0.006776	6.01	349.51	105.45	0.58
Alignment - (1)	7275	100yr	2600.00	7093.00	7097.87	7097.87	7098.39	0.004825	5.75	452.49	112.99	0.51
Alignment - (1)	7275	500yr	3800.00	7093.00	7100.09	7100.09	7100.52	0.002445	5.28	722.81	130.73	0.38
Alignment - (1)	7275	DP-69	1870.00	7093.00	7096.55	7096.55	7097.12	0.007680	6.03	310.28	102.43	0.61
Alignment - (1)	7265	10yr	1200.00	7093.00	7095.69	7094.97	7096.13	0.008418	5.34	224.80	95.52	0.61
Alignment - (1)	7265	50yr	2100.00	7093.00	7096.80	7096.80	7097.41	0.007664	6.26	335.43	104.37	0.62
Alignment - (1)	7265	100yr	2600.00	7093.00	7097.80	7097.80	7098.33	0.005087	5.85	444.46	112.42	0.52
Alignment - (1)	7265	500yr	3800.00	7093.00	7100.06	7100.06	7100.50	0.002487	5.31	718.92	130.50	0.39
Alignment - (1)	7265	DP-69	1870.00	7093.00	7096.38	7096.38	7097.01	0.009200	6.40	292.25	101.01	0.66
Alignment - (1)	7255	10yr	1200.00	7093.00	7094.97	7094.97	7095.87	0.024854	7.58	158.39	89.78	1.01
Alignment - (1)	7255	50yr	2100.00	7093.00	7096.61	7096.61	7097.30	0.009133	6.64	316.40	102.90	0.67
Alignment - (1)	7255	100yr	2600.00	7093.00	7097.72	7097.72	7098.28	0.005409	5.97	435.32	111.77	0.53
Alignment - (1)	7255	500yr	3800.00	7093.00	7100.03	7100.03	7100.47	0.002530	5.34	715.04	130.26	0.39
Alignment - (1)	7255	DP-69	1870.00	7093.00	7096.05	7096.05	7096.85	0.013221	7.21	259.30	98.36	0.78
Alignment - (1)	7225	10yr	1200.00	7087.00	7094.67	7094.67	7094.79	0.000844	2.76	435.11	87.39	0.22
Alignment - (1)	7225	50yr	2100.00	7087.00	7096.81	7096.81	7096.98	0.000909	3.28	639.76	104.46	0.23
Alignment - (1)	7225	100yr	2600.00	7087.00	7097.85	7097.85	7098.04	0.000897	3.45	753.11	112.81	0.24
Alignment - (1)	7225	500yr	3800.00	7087.00	7100.11	7100.11	7100.32	0.000765	3.71	1028.17	131.03	0.23
Alignment - (1)	7225	DP-69	1870.00	7087.00	7096.30	7096.30	7096.46	0.000907	3.18	587.74	100.40	0.23
Alignment - (1)	7205	10yr	1200.00	7087.00	7094.66	7094.66	7094.78	0.000853	2.77	433.70	87.34	0.22
Alignment - (1)	7205	50yr	2100.00	7087.00	7096.79	7096.79	7096.96	0.000917	3.29	638.14	104.45	0.23
Alignment - (1)	7205	100yr	2600.00	7087.00	7097.83	7097.83	7098.02	0.000903	3.46	751.56	112.83	0.24
Alignment - (1)	7205	500yr	3800.00	7087.00	7100.09	7100.09	7100.31	0.000748	3.74	1015.26	126.19	0.22
Alignment - (1)	7205	DP-69	1870.00	7087.00	7096.28	7096.28	7096.44	0.000915	3.19	586.13	100.38	0.23
Alignment - (1)	7204	10yr	1200.00	7089.00	7094.59	7094.59	7094.76	0.001567	3.34	359.63	86.78	0.29
Alignment - (1)	7204	50yr	2100.00	7089.00	7096.73	7096.73	7096.94	0.001369	3.73	563.73	103.96	0.28
Alignment - (1)	7204	100yr	2600.00	7089.00	7097.78	7097.78	7098.01	0.001264	3.84	677.23	112.38	0.28
Alignment - (1)	7204	500yr	3800.00	7089.00	7100.05	7100.05	7100.30	0.000979	4.01	950.51	126.02	0.25
Alignment - (1)	7204	DP-69	1870.00	7089.00	7096.22	7096.22	7096.42	0.001420	3.65	511.68	99.86	0.28
Alignment - (1)	7175	10yr	1200.00	7089.00	7094.33	7092.16	7094.65	0.002702	4.59	261.64	67.92	0.38
Alignment - (1)	7175	50yr	2100.00	7089.00	7096.34	7093.28	7096.81	0.002378	5.52	380.36	69.00	0.38

HEC-RAS Plan: Proposed Profiles River: Sand Creek Reach: Alignment - (1) (Continued)

Reach	River Sta	Profile	Q Total (cfs)	Min Ch El (ft)	W.S. Elev (ft)	Crit W.S. (ft)	E.G. Elev (ft)	E.G. Slope (ft/ft)	Vel Chnl (ft/s)	Flow Area (sq ft)	Top Width (ft)	Froude # Chl
Alignment - (1)	7175	100yr	2600.00	7089.00	7097.31	7093.80	7097.86	0.002281	5.94	437.75	69.00	0.38
Alignment - (1)	7175	500yr	3800.00	7089.00	7099.40	7094.94	7100.12	0.002130	6.77	561.11	69.00	0.39
Alignment - (1)	7175	DP-69	1870.00	7089.00	7095.86	7093.04	7096.30	0.002435	5.31	352.24	69.00	0.38
Alignment - (1)	7039		Culvert									
Alignment - (1)	6929	10yr	1200.00	7088.70	7092.02	7092.02	7093.39	0.016698	9.38	128.00	54.15	0.99
Alignment - (1)	6929	50yr	2100.00	7088.70	7093.26	7093.26	7095.25	0.014825	11.32	185.58	60.80	1.00
Alignment - (1)	6929	100yr	2600.00	7088.70	7093.88	7093.88	7096.17	0.014059	12.13	214.33	60.80	0.99
Alignment - (1)	6929	500yr	3800.00	7088.70	7095.23	7095.23	7098.16	0.012821	13.73	276.69	60.80	0.99
Alignment - (1)	6929	DP-69	1870.00	7088.70	7092.97	7092.97	7094.81	0.015113	10.87	172.10	60.80	0.99
Alignment - (1)	6889	10yr	1200.00	7088.62	7091.39	7091.39	7092.53	0.008292	8.55	140.31	62.27	1.00
Alignment - (1)	6889	50yr	2100.00	7088.62	7092.48	7092.48	7093.99	0.007597	9.86	213.06	71.41	1.01
Alignment - (1)	6889	100yr	2600.00	7088.62	7092.99	7092.99	7094.66	0.007309	10.36	250.93	75.74	1.00
Alignment - (1)	6889	500yr	3800.00	7088.62	7094.01	7094.01	7096.05	0.006930	11.44	332.55	84.74	1.01
Alignment - (1)	6889	DP-69	1870.00	7088.62	7092.23	7092.23	7093.65	0.007687	9.56	195.68	69.34	1.00
Alignment - (1)	6760	10yr	1200.00	7088.36	7090.27	7090.27	7091.17	0.008948	7.60	158.00	88.65	1.00
Alignment - (1)	6760	50yr	2100.00	7088.36	7091.10	7091.10	7092.33	0.008119	8.89	236.98	102.43	1.01
Alignment - (1)	6760	100yr	2600.00	7088.36	7091.53	7091.53	7092.88	0.007224	9.33	284.07	119.86	0.97
Alignment - (1)	6760	500yr	3800.00	7088.36	7092.42	7092.42	7093.99	0.005995	10.19	402.48	147.77	0.93
Alignment - (1)	6760	DP-69	1870.00	7088.36	7090.93	7090.93	7092.06	0.008227	8.52	219.59	99.45	1.00
Alignment - (1)	6379	10yr	1200.00	7080.17	7084.22	7084.22	7084.79	0.010759	6.10	196.76	177.29	1.02
Alignment - (1)	6379	50yr	2100.00	7080.17	7084.81	7084.75	7085.54	0.008261	6.87	307.62	196.00	0.95
Alignment - (1)	6379	100yr	2600.00	7080.17	7085.10	7084.99	7085.90	0.007296	7.21	365.05	200.02	0.92
Alignment - (1)	6379	500yr	3800.00	7080.17	7085.71	7085.52	7086.68	0.006131	7.94	489.73	208.73	0.88
Alignment - (1)	6379	DP-69	1870.00	7080.17	7084.64	7084.64	7085.37	0.009598	6.87	273.48	193.39	1.00

Appendix E: Contech Bridge Design Analysis

Finite Element Analysis Report by CANDE (Culvert Analysis and Design)

Sterling Ranch Colorado Springs

Merlin# 635632

Colorado Springs, Colorado

March 2, 2022

The purpose of this report is to present the study of how a BridgeCor structure is expected to behave with the site conditions including soils information. A CANDE analysis was performed assuming the soil conditions based on provided information and some assumptions, which are summarized on the following pages. This report will examine: combined thrust and moment, seam strength, wall area, global buckling, and deflection, and unfactored footing reactions. The analysis was in accordance with the AASHTO LRFD Bridge Design Specification.

Structure:

Maximum Span: 43'-0"
Bottom Span: 41'-11"
Rise: 26'-4"
Design cover: 7'-0"
Gage: 5

Summary:

- a. Load Factors: 1.75 for Live Load and 1.50 for Dead Load
- b. Modified Load Factors: 1.05 for Live Load (Multiple Presence Factor)
- c. For this structure, HL-93 design truck (32,000 pound axles spaced at 14 feet) and HL-93 tandem (25,000 pound axles spaced at 4 feet) loading were used as live load. The HL-93 design truck governed. As required by AASHTO, the combination of loads was the factored Dead Load plus the factored Live Load, which is determined as the controlling load case.
- d. Resistance Factors: Plastic Hinge Resistance Factor (ϕ_h) = 0.90, Wall Area and Buckling Resistance Factor (ϕ_w) = 0.70, Seam Strength Resistance Factor (ϕ_{SS}) = 0.67.
- e. Properties: Area of the Wall Cross-Section = 0.3003 in.²/in., Moment of Inertia = 1.1436 in.⁴/in., Section Modulus = 0.3741 in.³/in., Plastic Section Modulus = 0.5224 in.³/in.
- f. Profile of the BridgeCor deep corrugated plate (See next page for profile and data table). Profile is 15" Pitch and 5.5" Depth.
- g. Density of the backfill soil on top of the structure = 120 pcf (pounds per cubic foot)
- h. Density of the soil outside of the excavation of the arches = 120 pcf (pounds per cubic foot)
- i. Calculations of the Live loads, dead loads, etc.: See the following summary report.



Product Details and Fabrication

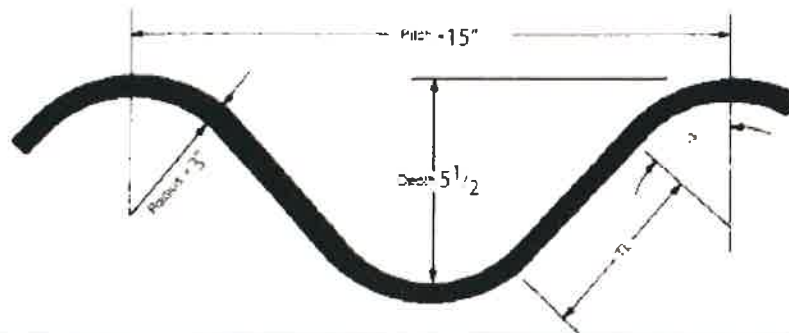

Table 2.14

Sectional properties of 15 x 5 1/2 in. (Annular)

Specified Thickness	Uncoated Thickness T	Area of Section A	Tangent Length T_L	Tangent Angle Δ	Moment of Inertia I	Section Modulus S	Radius of Gyration r	Developed Width Factor
(in.)	(in.)	(in. ² /ft)	(in.)	(Degrees)	(in. ⁴ /in)	(in. ³ /ft)	(in.)	
0.140	0.1345	2.260	4.361	49.75	0.7146	2.8406	1.9481	1.400
0.170	0.1644	2.762	4.323	49.89	0.8746	3.4602	1.9494	1.400
0.188	0.1838	3.088	4.299	49.99	0.9786	3.8599	1.9502	1.400
0.218	0.2145	3.604	4.259	50.13	1.1436	4.4888	1.9515	1.400
0.249	0.2451	4.118	4.220	50.28	1.3084	5.1114	1.9527	1.400
0.280	0.2758	4.633	4.179	50.43	1.4722	5.7317	1.9540	1.400
0.193	0.1875	3.150	4.293	50.00	0.9985	3.9359	1.9503	1.400
0.255	0.2500	4.200	4.213	50.31	1.3349	5.2107	1.9529	1.400
0.318	0.3125	5.250	4.131	50.62	1.6730	6.4678	1.9555	1.400
0.380	0.3750	6.300	4.047	50.94	2.0128	7.7076	1.9580	1.400

- Notes: 1. Per foot of projection about the neutral axis.
To obtain A or S per *inch* of width, divide the above values by 12.
2. Developed width factor measures the increase in profile length due to corrugating.
Dimensions are subject to manufacturing tolerances.

CANDE Generated Cross Section

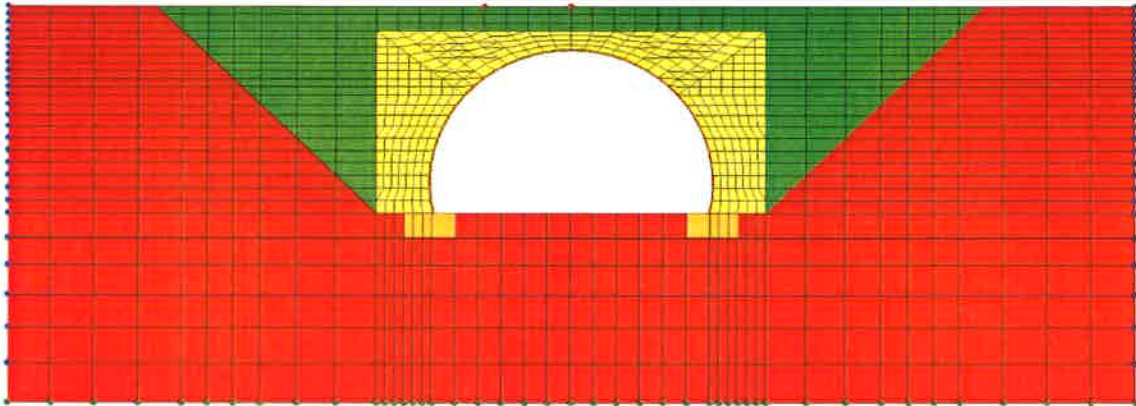

Single Radius Arch Bridge Cor: 58S 41'-11" Bottom Span x 26'-4" Rise (Inside Dimensions) Gage: 5

Height of cover above crown: 7'-0"

- Red mesh: Assumed: Isotropic-linear elastic, Young's modulus = 3,000 psi, Poisson's ratio = 0.30, density = 1 pcf (Density assumed to be 1 pcf to represent existing, consolidated soil – modeled to approximate no displacement)
- Green mesh: Embankment fill (assumed): Duncan/Selig SM90 , Density = 120 pcf
- Yellow mesh: Select backfill (assumed): Backfill width = 8'-0" , Duncan/Selig SW95, Density = 120 pcf
- Orange mesh: Reinforced concrete footing (assumed): Isotropic-linear elastic, Young's modulus = 3,500,000 psi, Poisson's ratio = 0.18, Density = 150 pcf
- Green boundary point: Displacement restricted in the vertical direction
- Blue boundary point: Displacement restricted in the horizontal direction
- Red boundary point: Force above crown of arch representing 32,000 pound, HL-93 Design Truck live load

*Design Criterion Summary:

- Wall Thrust Resistance Ratio = $32.77 / 111.0 = 0.295 < 1.00$ OK
- Global Buckling Resistance Ratio = $2.73103 / 10.96 = 0.249 < 1.00$ OK
- Seam Thrust Resistance Ratio = $32.77 / 85.09 = 0.385 < 1.00$ OK
- Combined Thrust & Moment Ratio = $0.732 < 1.00$ OK

*See sections below for more on calculations

CANDE Unfactored Thrust Reactions

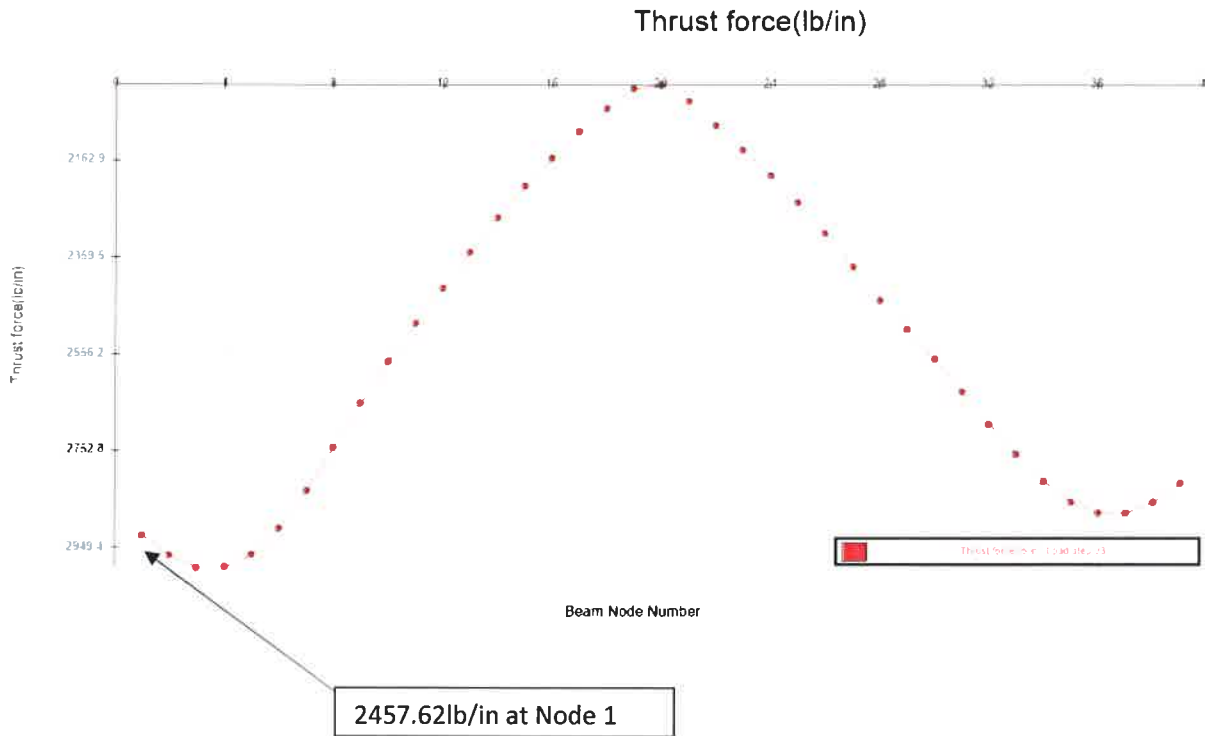

Base Angle: -12.95 degrees

Unfactored Vertical Footing Reaction: $R_V = \cos (-12.95) \times 2925.56 \times 12 = 34,214 \text{ lbs/ft}$

Unfactored Horizontal Footing Reaction: $R_H = \sin (-12.95) \times 2925.56 \times 12 = -7,867 \text{ lbs/ft}$

Notes:

- Each node represents a location along perimeter of cross-section
- Unfactored reactions are for each leg

AASHTO 12.8.9.5 (Combined Thrust & Moment Resistance) requires deep-corrugated metal plate structures to be analyzed using a finite element analysis. The results from the analysis are then used to compute a combined thrust and moment ratio (Combined T&M Ratio):

$$\text{Combined T\&M Ratio} = (T_f/R_t)^2 + M_u/M_n \leq 1.00$$

$$(\text{Factored thrust} / \text{Factored Thrust Resistance})^2 + (\text{Factored moment} / \text{Factored Moment Resistance}) \leq 1.00$$

The factored thrust resistance is the minimum yield point ($F_y = 44,000$ psi) multiplied by the area of wall cross-section (0.3003 in²/in for 5 gage) multiplied by the plastic hinge resistance factor (0.90). The factored moment resistance is the plastic moment capacity (23070 lbs-in/in for 5 gage) multiplied by the plastic hinge resistance factor. Refer to the NCSA Design manual (Table 2.14, pg. 37) for cross-section properties of BridgeCor.

The following graphs show the bending moments and thrust forces along the cross-section of the BridgeCor structure. The x-axis correlates to the distance along the perimeter of the cross-section of the Single Radius Arch BridgeCor structure in inches.

$$\text{Combined Thrust \& Moment Ratio} = (1763.55/(44,000 \times 0.3003 \times 0.90))^2 + (14744.5/(23070 \times 0.90)) = 0.732 < 1.00 \text{ OK}$$

Bending moment(lb-in/in): Load steps 1,2,3,4,5,6,7,8,9,10,11,12,13,14,15,16,17,18,19,20,21,22,23,

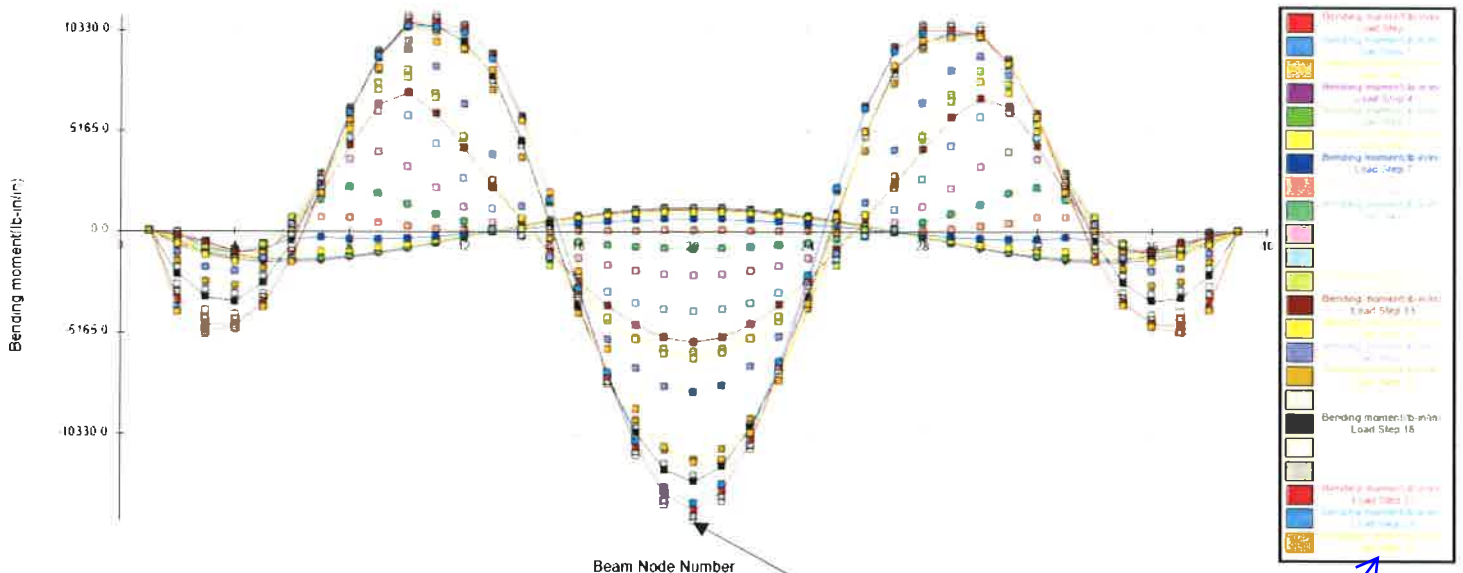

14744.5 lb-in/in
at Node 20

This is not legible -
please provide a
better copy

Thrust force(lb/in): Load steps 1,2,3,4,5,6,7,8,9,10,11,12,13,14,15,16,17,18,19,20,21,22,23,

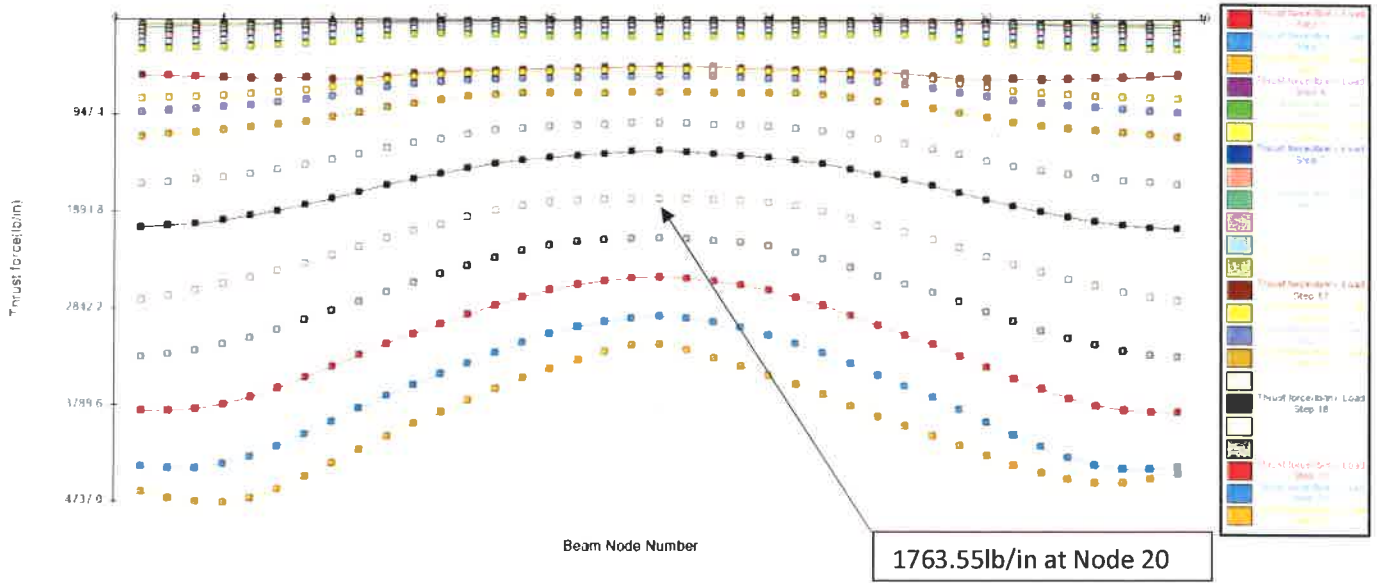

CANDE Controlling Node Output

NODE	X-COORD Y-COORD	X-DISP. Y-DISP.	N-PRES. S-PRES.	MOMENT THRUST	MAX-STRESS HOOP-STRESS	SHEAR S-STRESS
20	0.00 319.17	-0.141E-01 0.805E+00	-0.375E+01 -0.498E-01	-0.147E+05 -0.176E+04	-0.440E+05 -0.587E+04	-0.338E+01 -0.113E+02
39	254.12 0.00	0.326E+00 -0.246E+01	-0.777E+01 -0.130E+01	-0.161E-10 -0.277E+04	-0.923E+04 -0.923E+04	-0.143E+03 -0.476E+03

AASHTO Section 12.8.9.6 (Global Buckling) requires that the factored thrust in the culvert wall under the final installed condition shall not exceed the nominal resistance to general buckling capacity of the culvert, computed as:

$$R_b, \text{ nominal axial force in culvert wall to cause general buckling} = 1.2\Phi_b C_n (E_m I_p)^{1/3} (\Phi_s M_s K_b)^{2/3} R_h$$

Φ_b , resistance factor for general buckling = 0.70

C_n , scalar calibration factor to account for some nonlinear effects = 0.55

E_m , modulus of elasticity of pipe wall material = 29000 ksi

I_p , moment of inertia of stiffened culvert wall per unit length = 1.144 in⁴/in

Φ_s , resistance factor for soil = 0.9

γ , soil density = 120 pcf

R_{sp} , rise above springline = 258 inches

$P_{sp} = 0.5\gamma R_{sp} = 8.96$ psi

M_s , constrained modulus of embedment computed = 2.92 ksi based on the free field vertical stress at a depth

halfway between the top and springline of the

structure (Table 12.12.3.5-1)

ν , Poisson's ratio of soil = 0.30

$K_b = (1-2\nu)/(1-\nu^2) = 0.44$

R_h , correction factor for backfill geometry = 11.4/(11+S/H) = 0.67

S, culvert span = 503 inches

H, depth of fill over top of culvert = 84 inches

$$R_b = 1.2 \times 0.70 \times 0.55 \times (29000 \times 1.144)^{1/3} (0.9 \times 2.92 \times 0.44)^{2/3} (0.67) = 10.96 \text{ kips/in}$$

$$R_b = 10.96 \text{ kips/in} > \text{Max Factored Buckling Thrust} = 2.73103 \text{ kips/in}$$

$$\text{Global Buckling Resistance Ratio} = 2.73103 / 10.96 = 0.249 < 1.00 \text{ OK}$$

Table 12.12.3.5-1—M. Based on Soil Type and Compaction Condition

P_{sp} Stress Level (psi)	Sn-100 (ksi)	Sn-95 (ksi)	Sn-90 (ksi)	Sn-85 (ksi)
1.0	2.350	2.000	1.275	0.470
5.0	3.450	2.600	1.500	0.520
10.0	4.200	3.000	1.625	0.570
20.0	5.500	3.450	1.800	0.650
40.0	7.500	4.250	2.100	0.825
60.0	9.300	5.000	2.500	1.000
P_{sp} Stress Level (psi)		Si-95 (ksi)	Si-90 (ksi)	Si-85 (ksi)

AASHTO Section 12.7.2.3 (Wall Resistance) requires the wall resistance to be greater than the factored thrust.

The wall resistance is defined as:

$$R_w = \Phi_w F_y A_w$$

$$A_w = \text{wall area (in}^2\text{/ft)} = 3.604 \text{ in}^2\text{/ft}$$

$$F_y = \text{yield strength of metal} = 44 \text{ ksi}$$

$$R_w = \Phi_w F_y A_w = 0.70 \times 44 \times 3.604 = 111.0 \text{ kips/ft} > \text{Max Factored Material Thrust} = 32.77 \text{ kips/ft}$$

$$\text{Wall Thrust Resistance Ratio} = 32.77 / 111.0 = 0.295 < 1.00 \text{ OK}$$

AASHTO Section 12.7.2.5 (Seam Strength) requires the factored seam strength to be greater than the factored thrust.

The factored seam strength is defined as:

$$R_s = \Phi_{ss} SS$$

$$\Phi_{ss}, \text{ Seam Strength} = 0.67 \text{ (AASHTO Table 12.5.5-1)}$$

$$SS = \text{Seam Strength} = 127 \text{ kips/ft (from Table 7.4B on page 376 of the NCSA Design Manual).}$$

$$R_s = 0.67 \times 127 = 85.09 \text{ kips/ft} > \text{Max Factored Seam Thrust} = 32.77 \text{ kips/ft}$$

$$\text{Seam Thrust Resistance Ratio} = 32.77 / 85.09 = 0.385 < 1.00 \text{ OK}$$

CANDE Output Summary for controlling load step

ASSESSMENT SUMMARY STEEL-GROUP 1, LOAD-STEP 19

LRFD STRENGTH-LIMIT RATIOS AT STEP 19, FOR STEEL GROUP # 1

DESIGN-CRITERION	CONTROL NODE	FACTORED DEMAND	FACTORED CAPACITY	RATIO VALUE
MATERIAL THRUST (psi)	39	9233.	30800.	0.300
BUCKLING THRUST (psi)	39	9233.	46744.	0.198
SEAM THRUST (psi)	39	9233.	23052.	0.401
PLASTIC-PENETRATE (%)	20	1.68	90.00	0.019
COMBINED T&M Ratio	20	0.735	1.000	0.735

Displacement Y-Direction(in): Load steps 1,2,3,4,5,6,7,8,9,10,11,12,13,14,15,16,17,18,19,20,21,22,23,

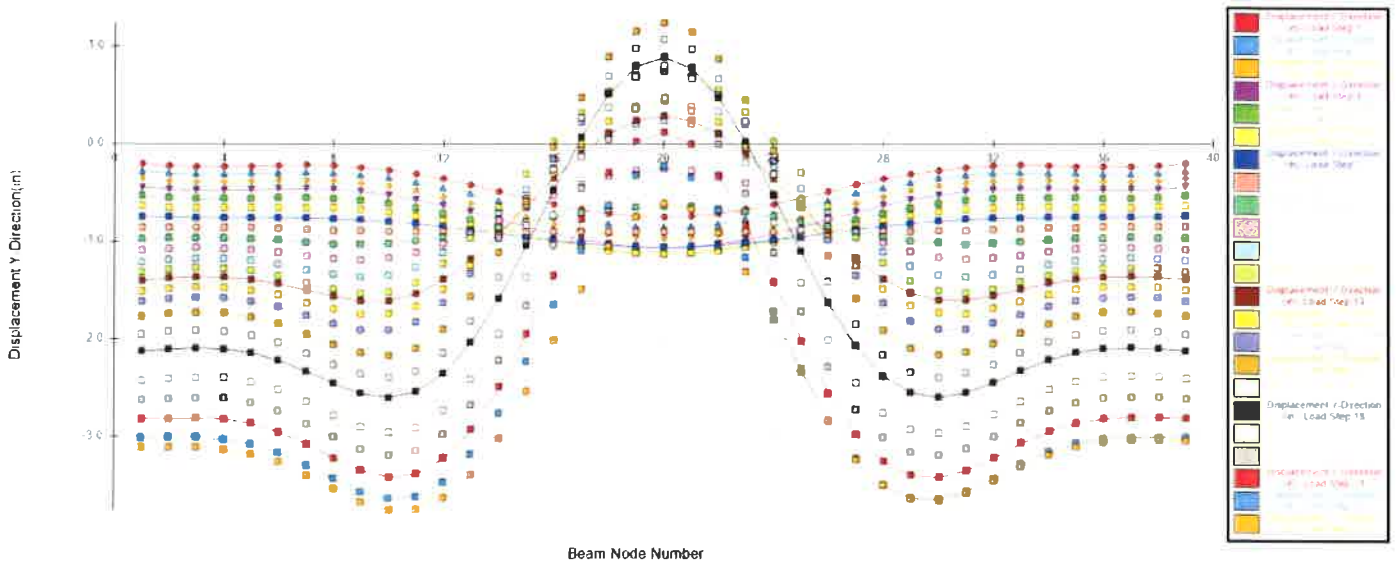

CANDE OUTPUT FOR CONTROLLING LOAD STEP 19

STRUCTURAL RESPONSES OF STEEL-GROUP 1, LOAD STEP 19

UNITS INCH-LB SYSTEM: (FORCE = LB/IN, MOMENT = IN-LB/IN, STRESS = PSI)

NODE	X-COORD Y-COORD	X-DISP. Y-DISP.	N-PRES. S-PRES.	MOMENT THRUST	MAX-STRESS HOOP-STRESS	SHEAR S-STRESS
1	-254.12 0.00	-0.320E+00 -0.246E+01	-0.799E+01 0.146E+01	0.371E-10 -0.277E+04	-0.922E+04 -0.922E+04	0.139E+03 0.462E+03
2	-258.50 24.26	-0.165E+00 -0.244E+01	-0.818E+01 0.200E+01	-0.276E+04 -0.272E+04	-0.165E+05 -0.907E+04	0.824E+02 0.274E+03
3	-260.57 48.82	0.329E-01 -0.243E+01	-0.837E+01 0.254E+01	-0.412E+04 -0.267E+04	-0.199E+05 -0.890E+04	0.311E+02 0.104E+03
4	-260.31 73.47	0.296E+00 -0.245E+01	-0.796E+01 0.240E+01	-0.430E+04 -0.261E+04	-0.202E+05 -0.869E+04	-0.172E+02 -0.572E+02
5	-257.73 97.98	0.625E+00 -0.249E+01	-0.765E+01 0.228E+01	-0.321E+04 -0.255E+04	-0.171E+05 -0.848E+04	-0.681E+02 -0.227E+03
6	-252.84 122.14	0.998E+00 -0.257E+01	-0.780E+01 0.227E+01	-0.831E+03 -0.248E+04	-0.105E+05 -0.825E+04	-0.115E+03 -0.382E+03
7	-245.70 145.73	0.137E+01 -0.270E+01	-0.865E+01 0.245E+01	0.259E+04 -0.241E+04	-0.149E+05 -0.801E+04	-0.142E+03 -0.474E+03
8	-236.35 168.54	0.169E+01 -0.284E+01	-0.102E+02 0.281E+01	0.634E+04 -0.233E+04	-0.247E+05 -0.775E+04	-0.133E+03 -0.443E+03
9	-224.90 190.36	0.190E+01 -0.296E+01	-0.105E+02 0.292E+01	0.929E+04 -0.224E+04	-0.323E+05 -0.747E+04	-0.935E+02 -0.311E+03
10	-211.44 211.01	0.198E+01 -0.301E+01	-0.111E+02 0.320E+01	0.111E+05 -0.216E+04	-0.368E+05 -0.719E+04	-0.344E+02 -0.115E+03
11	-196.08 230.29	0.191E+01 -0.296E+01	-0.874E+01 0.254E+01	0.111E+05 -0.209E+04	-0.366E+05 -0.695E+04	0.107E+02 0.357E+02
12	-178.98 248.04	0.171E+01 -0.278E+01	-0.925E+01 0.279E+01	0.106E+05 -0.202E+04	-0.350E+05 -0.673E+04	0.398E+02 0.133E+03
13	-160.27 264.09	0.142E+01 -0.245E+01	-0.103E+02 0.324E+01	0.912E+04 -0.195E+04	-0.309E+05 -0.650E+04	0.950E+02 0.316E+03

14	-140.14 278.31	0.106E+01 -0.198E+01	-0.904E+01 0.291E+01	0.585E+04 -0.189E+04	-0.219E+05 -0.628E+04	0.154E+03 0.513E+03
15	-118.75 290.56	0.712E+00 -0.139E+01	-0.746E+01 0.246E+01	0.140E+04 -0.184E+04	-0.984E+04 -0.611E+04	0.183E+03 0.610E+03
16	-96.30 300.73	0.407E+00 -0.752E+00	-0.628E+01 0.159E+01	-0.338E+04 -0.180E+04	-0.150E+05 -0.600E+04	0.182E+03 0.607E+03
17	-72.98 308.74	0.183E+00 -0.140E+00	-0.542E+01 0.892E+00	-0.783E+04 -0.179E+04	-0.269E+05 -0.595E+04	0.159E+03 0.530E+03
18	-49.02 314.51	0.501E-01 0.366E+00	-0.489E+01 0.785E+00	-0.115E+05 -0.178E+04	-0.365E+05 -0.592E+04	0.120E+03 0.398E+03
19	-24.62 318.00	-0.419E-02 0.697E+00	-0.410E+01 0.688E+00	-0.139E+05 -0.177E+04	-0.431E+05 -0.589E+04	0.648E+02 0.216E+03
20	0.00 319.17	-0.141E-01 0.805E+00	-0.375E+01 -0.498E-01	-0.147E+05 -0.176E+04	-0.440E+05 -0.587E+04	-0.338E+01 -0.113E+02
21	24.62 318.00	-0.253E-01 0.673E+00	-0.413E+01 -0.696E+00	-0.137E+05 -0.177E+04	-0.426E+05 -0.589E+04	-0.713E+02 -0.237E+03
22	49.02 314.51	-0.830E-01 0.320E+00	-0.490E+01 -0.782E+00	-0.111E+05 -0.178E+04	-0.357E+05 -0.592E+04	-0.126E+03 -0.418E+03
23	72.98 308.74	-0.220E+00 -0.203E+00	-0.548E+01 -0.921E+00	-0.735E+04 -0.179E+04	-0.256E+05 -0.595E+04	-0.164E+03 -0.547E+03
24	96.30 300.73	-0.447E+00 -0.823E+00	-0.642E+01 -0.170E+01	-0.279E+04 -0.180E+04	-0.135E+05 -0.600E+04	-0.185E+03 -0.617E+03
25	118.75 290.56	-0.752E+00 -0.146E+01	-0.765E+01 -0.252E+01	0.201E+04 -0.184E+04	-0.115E+05 -0.612E+04	-0.182E+03 -0.606E+03
26	140.14 278.31	-0.110E+01 -0.204E+01	-0.919E+01 -0.295E+01	0.637E+04 -0.189E+04	-0.233E+05 -0.630E+04	-0.149E+03 -0.496E+03
27	160.27 264.09	-0.144E+01 -0.250E+01	-0.107E+02 -0.334E+01	0.947E+04 -0.196E+04	-0.318E+05 -0.652E+04	-0.841E+02 -0.280E+03
28	178.98 248.04	-0.172E+01 -0.281E+01	-0.928E+01 -0.278E+01	0.106E+05 -0.203E+04	-0.350E+05 -0.676E+04	-0.250E+02 -0.831E+02
29	196.08 230.29	-0.190E+01 -0.297E+01	-0.844E+01 -0.244E+01	0.107E+05 -0.210E+04	-0.356E+05 -0.698E+04	-0.104E+00 -0.347E+00

30	211.44 211.01	-0.195E+01 -0.301E+01	-0.107E+02 -0.308E+01	0.105E+05 -0.217E+04	-0.353E+05 -0.722E+04	0.356E+02 0.119E+03
31	224.90 190.36	-0.187E+01 -0.295E+01	-0.104E+02 -0.290E+01	0.884E+04 -0.225E+04	-0.311E+05 -0.749E+04	0.880E+02 0.293E+03
32	236.35 168.54	-0.165E+01 -0.283E+01	-0.102E+02 -0.283E+01	0.606E+04 -0.233E+04	-0.240E+05 -0.776E+04	0.126E+03 0.421E+03
33	245.70 145.73	-0.134E+01 -0.269E+01	-0.876E+01 -0.249E+01	0.246E+04 -0.241E+04	-0.146E+05 -0.803E+04	0.137E+03 0.457E+03
34	252.84 122.14	-0.967E+00 -0.257E+01	-0.790E+01 -0.230E+01	-0.861E+03 -0.248E+04	-0.106E+05 -0.827E+04	0.112E+03 0.372E+03
35	257.73 97.98	-0.599E+00 -0.248E+01	-0.777E+01 -0.231E+01	-0.319E+04 -0.255E+04	-0.170E+05 -0.850E+04	0.673E+02 0.224E+03
36	260.31 73.47	-0.275E+00 -0.244E+01	-0.806E+01 -0.243E+01	-0.429E+04 -0.262E+04	-0.202E+05 -0.871E+04	0.183E+02 0.611E+02
37	260.57 48.82	-0.157E-01 -0.243E+01	-0.836E+01 -0.254E+01	-0.415E+04 -0.268E+04	-0.200E+05 -0.892E+04	-0.296E+02 -0.987E+02
38	258.50 24.26	0.177E+00 -0.244E+01	-0.807E+01 -0.192E+01	-0.282E+04 -0.273E+04	-0.166E+05 -0.909E+04	-0.831E+02 -0.277E+03
39	254.12 0.00	0.326E+00 -0.246E+01	-0.777E+01 -0.130E+01	-0.161E-10 -0.277E+04	-0.923E+04 -0.923E+04	-0.143E+03 -0.476E+03

Finite Element Analysis Report by CANDE (Culvert Analysis and Design)

Sterling Ranch Colorado Springs

Merlin# 635632

Colorado Springs, Colorado

March 2, 2022

The purpose of this report is to present the study of how a BridgeCor structure is expected to behave with the site conditions including soils information. A CANDE analysis was performed assuming the soil conditions based on provided information and some assumptions, which are summarized on the following pages. This report will examine: combined thrust and moment, seam strength, wall area, global buckling, and deflection, and unfactored footing reactions. The analysis was in accordance with the AASHTO LRFD Bridge Design Specification.

Structure:

Maximum Span: 43'-0"

Bottom Span: 41'-11"

Rise: 26'-4"

Design cover: 5'-0"

Gage: 5

Summary:

- a. Load Factors: 1.75 for Live Load and 1.50 for Dead Load
- b. Modified Load Factors: 1.05 for Live Load (Multiple Presence Factor)
- c. For this structure, HL-93 design truck (32,000 pound axles spaced at 14 feet) and HL-93 tandem (25,000 pound axles spaced at 4 feet) loading were used as live load. The HL-93 design truck governed. As required by AASHTO, the combination of loads was the factored Dead Load plus the factored Live Load, which is determined as the controlling load case.
- d. Resistance Factors: Plastic Hinge Resistance Factor (ϕ_h) = 0.90, Wall Area and Buckling Resistance Factor (ϕ_w) = 0.70, Seam Strength Resistance Factor (ϕ_{SS}) = 0.67.
- e. Properties: Area of the Wall Cross-Section = 0.3003 in.²/in., Moment of Inertia = 1.1436 in.⁴/in., Section Modulus = 0.3741 in.³/in., Plastic Section Modulus = 0.5224 in.³/in.
- f. Profile of the BridgeCor deep corrugated plate (See next page for profile and data table). Profile is 15" Pitch and 5.5" Depth.
- g. Density of the backfill soil on top of the structure = 120 pcf (pounds per cubic foot)
- h. Density of the soil outside of the excavation of the arches = 120 pcf (pounds per cubic foot)
- i. Calculations of the Live loads, dead loads, etc.: See the following summary report.

Product Details and Fabrication

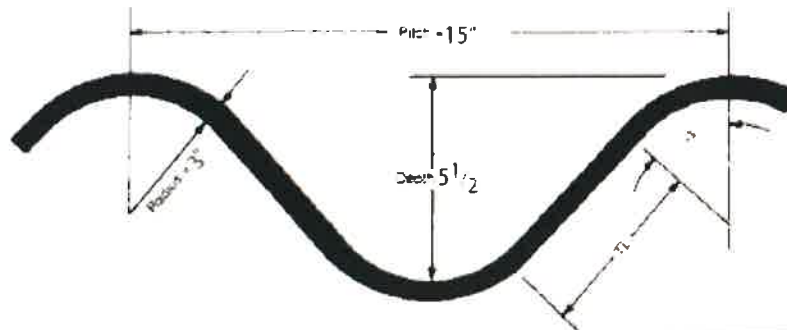

Table 2.14

Sectional properties of 15 x 5 1/2 in. (Annular)

Specified Thickness	Uncoated Thickness T	Area of Section A	Tangent Length T_L	Tangent Angle Δ	Moment of Inertia I	Section Modulus S	Radius of Gyration r	Developed Width Factor
(in.)	(in.)	(in. ² /ft)	(in.)	(Degrees)	(in. ⁴ /in)	(in. ³ /ft)	(in.)	
0.140	0.1345	2.260	4.361	49.75	0.7146	2.8406	1.9481	1.400
0.170	0.1644	2.762	4.323	49.89	0.8746	3.4602	1.9494	1.400
0.188	0.1838	3.088	4.299	49.99	0.9786	3.8599	1.9502	1.400
0.218	0.2145	3.604	4.259	50.13	1.1436	4.4888	1.9515	1.400
0.249	0.2451	4.118	4.220	50.28	1.3084	5.1114	1.9527	1.400
0.280	0.2758	4.633	4.179	50.43	1.4722	5.7317	1.9540	1.400
0.193	0.1875	3.150	4.293	50.00	0.9985	3.9359	1.9503	1.400
0.255	0.2500	4.200	4.213	50.31	1.3349	5.2107	1.9529	1.400
0.318	0.3125	5.250	4.131	50.62	1.6730	6.4678	1.9555	1.400
0.380	0.3750	6.300	4.047	50.94	2.0128	7.7076	1.9580	1.400

Notes: 1. Per foot of projection about the neutral axis.

To obtain A or S per *inch* of width, divide the above values by 12.

2. Developed width factor measures the increase in profile length due to corrugating. Dimensions are subject to manufacturing tolerances.

CANDE Generated Cross Section

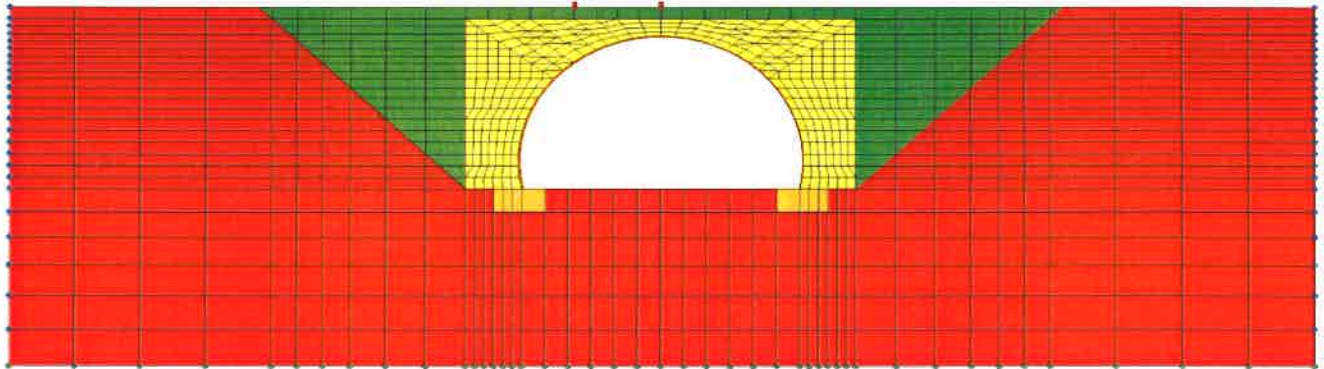

Single Radius Arch Bridge Cor: 58S 41'-11" Bottom Span x 26'-4" Rise (Inside Dimensions) Gage: 5

Height of cover above crown: 5'-0"

- Red mesh: Assumed: Isotropic-linear elastic, Young's modulus = 3,000 psi, Poisson's ratio = 0.30, density = 1 pcf (Density assumed to be 1 pcf to represent existing, consolidated soil – modeled to approximate no displacement)
- Green mesh: Embankment fill (assumed): Duncan/Selig SM90 , Density = 120 pcf
- Yellow mesh: Select backfill (assumed): Backfill width = 8'-0", Duncan/Selig SW95, Density = 120 pcf
- Orange mesh: Reinforced concrete footing (assumed): Isotropic-linear elastic, Young's modulus = 3,500,000 psi, Poisson's ratio = 0.18, Density = 150 pcf
- Green boundary point: Displacement restricted in the vertical direction
- Blue boundary point: Displacement restricted in the horizontal direction
- Red boundary point: Force above crown of arch representing 32,000 pound, HL-93 Design Truck live load

***Design Criterion Summary:**

- Wall Thrust Resistance Ratio = $32.79 / 111.0 = 0.295 < 1.00$ OK
- Global Buckling Resistance Ratio = $2.73216 / 9.60 = 0.284 < 1.00$ OK
- Seam Thrust Resistance Ratio = $32.79 / 85.09 = 0.385 < 1.00$ OK
- Combined Thrust & Moment Ratio = $0.727 < 1.00$ OK

*See sections below for more on calculations

CANDE Unfactored Thrust Reactions

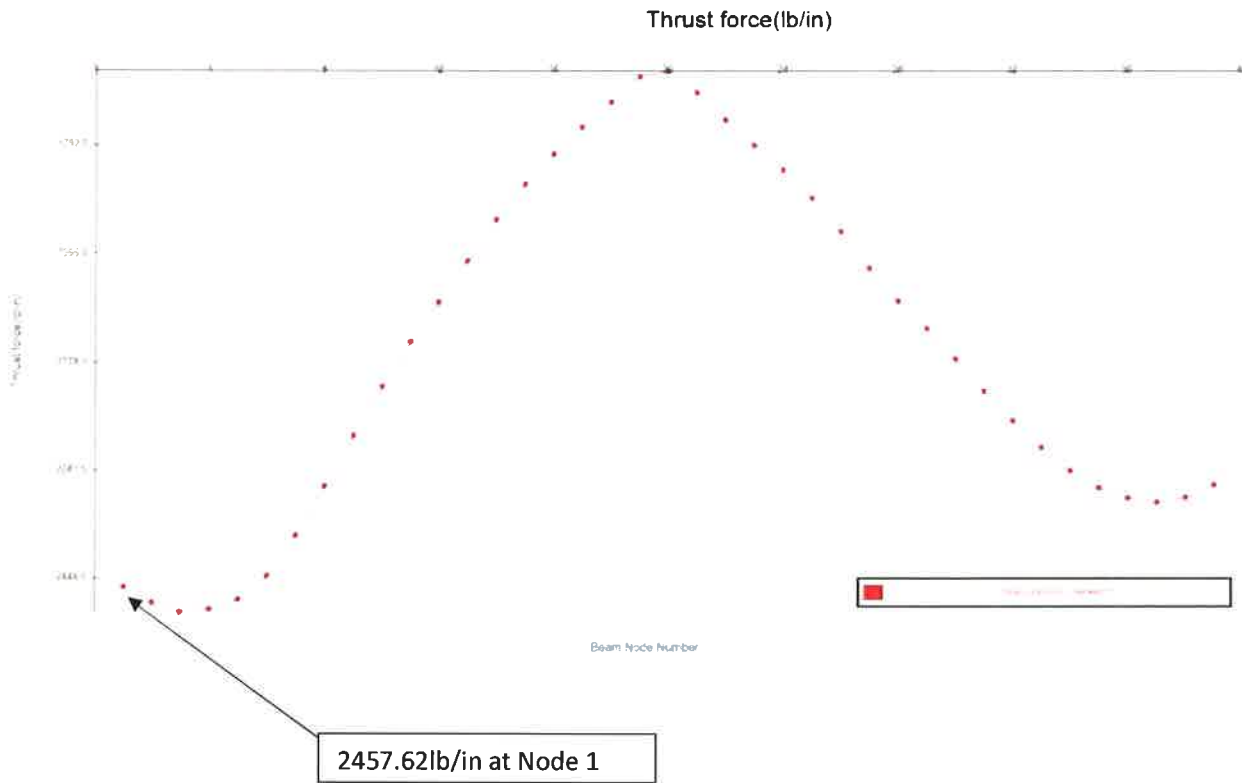

Base Angle: -12.95 degrees

Unfactored Vertical Footing Reaction: $R_v = \cos (-12.95) \times 2457.62 \times 12 = 28,741 \text{ lbs/ft}$

Unfactored Horizontal Footing Reaction: $R_H = \sin (-12.95) \times 2457.62 \times 12 = -6,609 \text{ lbs/ft}$

Notes:

- Each node represents a location along perimeter of cross-section
- Unfactored reactions are for each leg

AASHTO 12.8.9.5 (Combined Thrust & Moment Resistance) requires deep-corrugated metal plate structures to be analyzed using a finite element analysis. The results from the analysis are then used to compute a combined thrust and moment ratio (Combined T&M Ratio):

$$\text{Combined T\&M Ratio} = (T_f/R_t)^2 + M_u/M_n \leq 1.00$$

$$(\text{Factored thrust} / \text{Factored Thrust Resistance})^2 + (\text{Factored moment} / \text{Factored Moment Resistance}) \leq 1.00$$

The factored thrust resistance is the minimum yield point ($F_y = 44,000$ psi) multiplied by the area of wall cross-section (0.3003 in²/in for 5 gage) multiplied by the plastic hinge resistance factor (0.90). The factored moment resistance is the plastic moment capacity (23070 lbs-in/in for 5 gage) multiplied by the plastic hinge resistance factor. Refer to the NCSA Design manual (Table 2.14, pg. 37) for cross-section properties of BridgeCor.

The following graphs show the bending moments and thrust forces along the cross-section of the BridgeCor structure. The x-axis correlates to the distance along the perimeter of the cross-section of the Two Radius Arch BridgeCor structure in inches.

$$\text{Combined Thrust \& Moment Ratio} = (1759.78/(44,000 \times 0.3003 \times 0.90))^2 + (14634.7/(23070 \times 0.90)) = 0.727 < 1.00 \text{ OK}$$

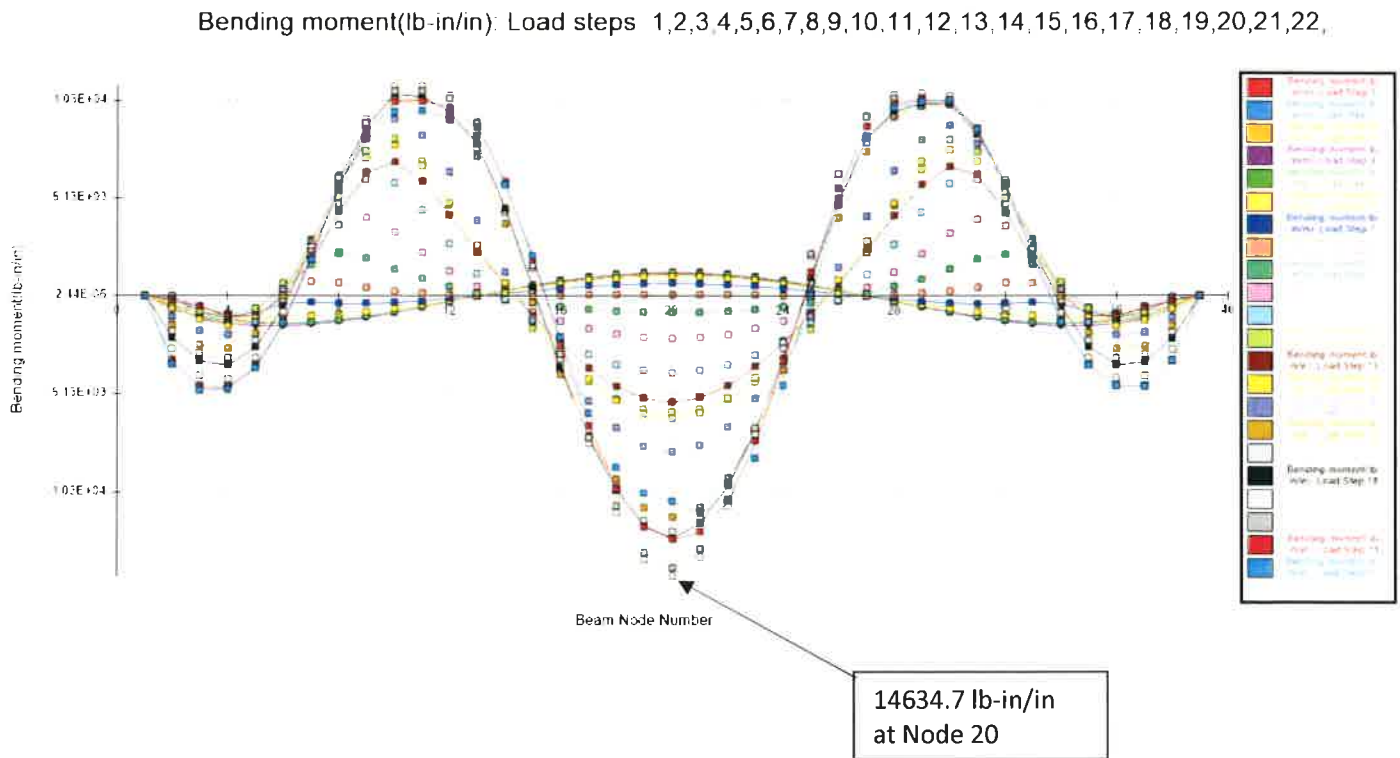

Thrust force(lb/in): Load steps 1,2,3,4,5,6,7,8,9,10,11,12,13,14,15,16,17,18,19,20,21,22,

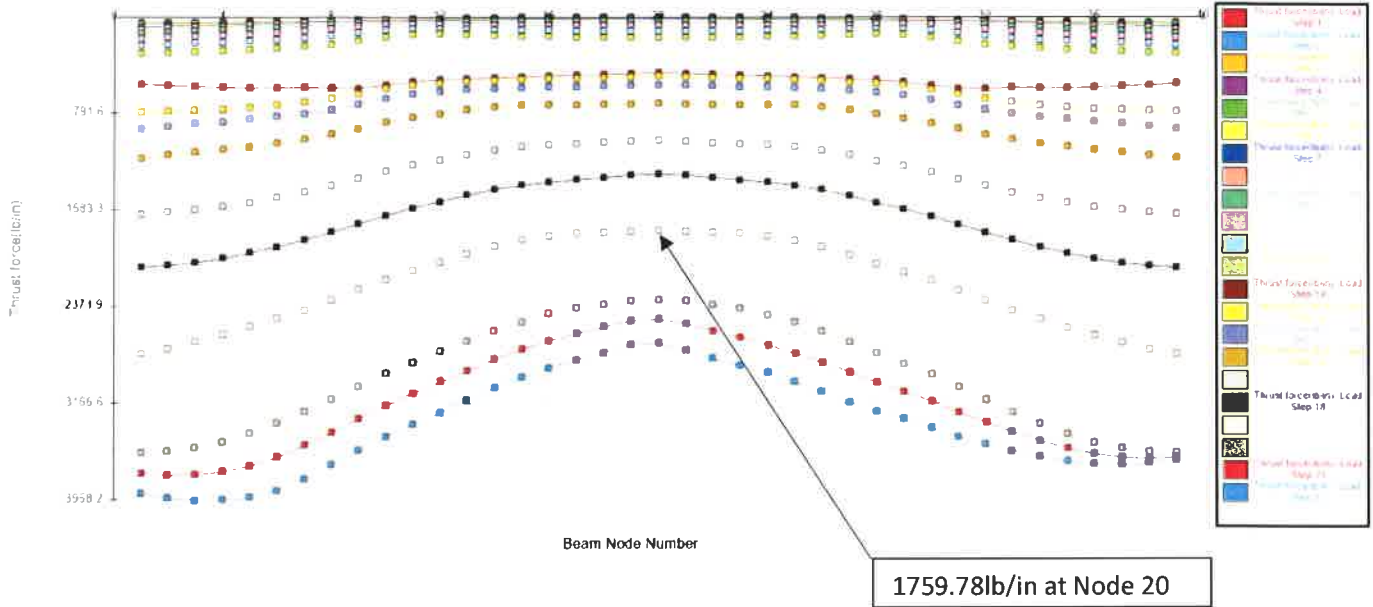

CANDE Controlling Node Output

NODE	X-COORD Y-COORD	X-DISP. Y-DISP.	N-PRES. S-PRES.	MOMENT THRUST	MAX-STRESS HOOP-STRESS	SHEAR S-STRESS
20	0.00 319.17	-0.140E-01 0.742E+00	-0.374E+01 -0.477E-01	-0.146E+05 -0.176E+04	-0.440E+05 -0.586E+04	-0.338E+01 -0.113E+02
39	254.12 0.00	0.355E+00 -0.247E+01	-0.781E+01 -0.127E+01	-0.290E-10 -0.277E+04	-0.923E+04 -0.923E+04	-0.144E+03 -0.479E+03

AASHTO Section 12.8.9.6 (Global Buckling) requires that the factored thrust in the culvert wall under the final installed condition shall not exceed the nominal resistance to general buckling capacity of the culvert, computed as:

$$R_b, \text{ nominal axial force in culvert wall to cause general buckling} = 1.2\Phi_b C_n (E_m I_p)^{1/3} (\Phi_s M_s K_b)^{2/3} R_h$$

Φ_b , resistance factor for general buckling = 0.70

C_n , scalar calibration factor to account for some nonlinear effects = 0.55

E_m , modulus of elasticity of pipe wall material = 29000 ksi

I_p , moment of inertia of stiffened culvert wall per unit length = 1.144 in⁴/in

Φ_s , resistance factor for soil = 0.9

γ , soil density = 120 pcf

R_{sp} , rise above springline = 258 inches

$P_{sp} = 0.5\gamma R_{sp} = 8.96$ psi

M_s , constrained modulus of embedment computed = 2.92 ksi

based on the free field vertical stress at a depth

halfway between the top and springline of the

structure (Table 12.12.3.5-1)

ν , Poisson's ratio of soil = 0.30

$K_b = (1 - 2\nu)/(1 - \nu^2) = 0.44$

R_h , correction factor for backfill geometry = 11.4/(11+S/H) = 0.59

S, culvert span = 503 inches

H, depth of fill over top of culvert = 60 inches

$$R_b = 1.2 \times 0.70 \times 0.55 \times (29000 \times 1.144)^{1/3} (0.9 \times 2.92 \times 0.44)^{2/3} (0.59) = 9.60 \text{ kips/in}$$

$$R_b = 9.60 \text{ kips/in} > \text{Max Factored Buckling Thrust} = 2.73216 \text{ kips/in}$$

$$\text{Global Buckling Resistance Ratio} = 2.73216 / 9.60 = 0.284 < 1.00 \text{ OK}$$

Table 12.12.3.5-1—M. Based on Soil Type and Compaction Condition

P_{sp} Stress Level (psi)	Sn-100 (ksi)	Sn-95 (ksi)	Sn-90 (ksi)	Sn-85 (ksi)
1.0	2.350	2.000	1.275	0.470
5.0	3.450	2.600	1.500	0.520
10.0	4.200	3.000	1.625	0.570
20.0	5.500	3.450	1.800	0.650
40.0	7.500	4.250	2.100	0.825
60.0	9.300	5.000	2.500	1.000
P_{sp} Stress Level (psi)		Si-95 (ksi)	Si-90 (ksi)	Si-85 (ksi)

AASHTO Section 12.7.2.3 (Wall Resistance) requires the wall resistance to be greater than the factored thrust.

The wall resistance is defined as:

$$R_w = \Phi_w F_y A_w$$

$$A_w = \text{wall area (in}^2\text{/ft)} = 3.604 \text{ in}^2\text{/ft}$$

$$F_y = \text{yield strength of metal} = 44 \text{ ksi}$$

$$R_w = \Phi_w F_y A_w = 0.70 \times 44 \times 3.604 = 111.0 \text{ kips/ft} > \text{Max Factored Material Thrust} = 32.79 \text{ kips/ft}$$

$$\text{Wall Thrust Resistance Ratio} = 32.79 / 111.0 = 0.295 < 1.00 \text{ OK}$$

AASHTO Section 12.7.2.5 (Seam Strength) requires the factored seam strength to be greater than the factored thrust.

The factored seam strength is defined as:

$$R_s = \Phi_{ss} SS$$

$$\Phi_{ss}, \text{ Seam Strength} = 0.67 \text{ (AASHTO Table 12.5.5-1)}$$

$$SS = \text{Seam Strength} = 127 \text{ kips/ft (from Table 7.4B on page 376 of the NCSA Design Manual).}$$

$$R_s = 0.67 \times 127 = 85.09 \text{ kips/ft} > \text{Max Factored Seam Thrust} = 32.79 \text{ kips/ft}$$

$$\text{Seam Thrust Resistance Ratio} = 32.79 / 85.09 = 0.385 < 1.00 \text{ OK}$$

CANDE Output Summary for controlling load step

ASSESSMENT SUMMARY STEEL-GROUP 1, LOAD-STEP 19

LRFD STRENGTH-LIMIT RATIOS AT STEP 19, FOR STEEL GROUP # 1

DESIGN-CRITERION	CONTROL NODE	FACTORED DEMAND	FACTORED CAPACITY	RATIO VALUE
MATERIAL THRUST (psi)	39	9235.	30800.	0.300
BUCKLING THRUST (psi)	39	9235.	40838.	0.226
SEAM THRUST (psi)	39	9235.	23052.	0.401
PLASTIC-PENETRATE (%)	20	1.28	90.00	0.014
COMBINED T&M Ratio	20	0.729	1.000	0.729

Displacement Y-Direction(in): Load steps 1,2,3,4,5,6,7,8,9,10,11,12,13,14,15,16,17,18,19,20,21,22,

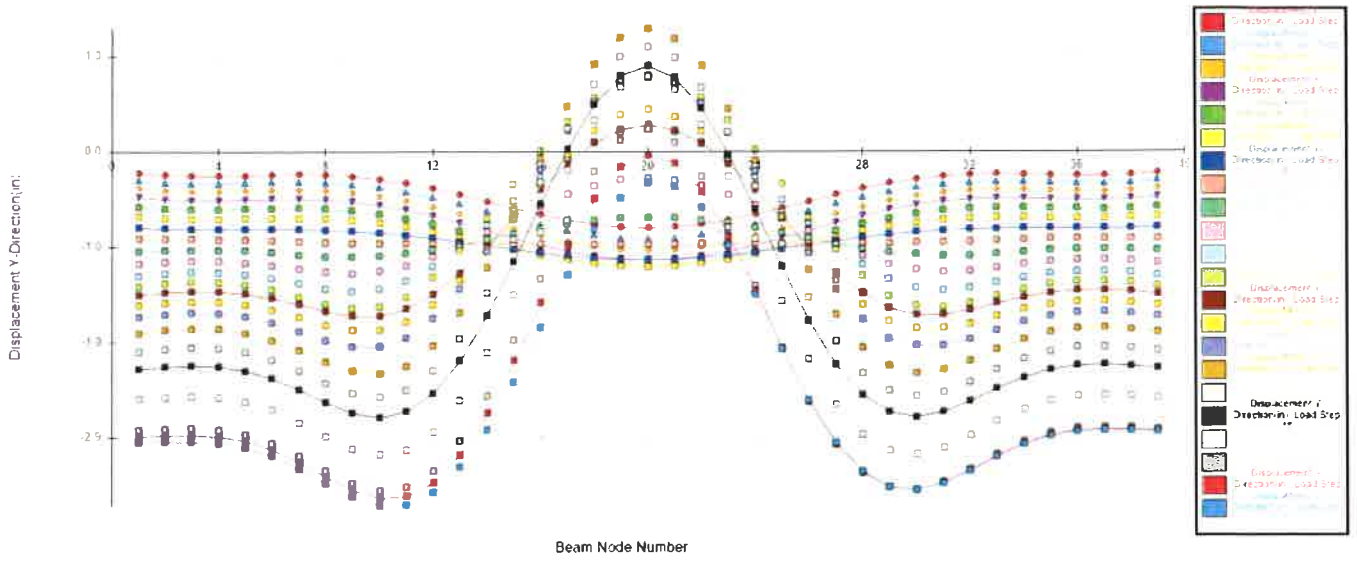

CANDE OUTPUT FOR CONTROLLING LOAD STEP 19

STRUCTURAL RESPONSES OF STEEL-GROUP 1, LOAD STEP 19

UNITS INCH-LB SYSTEM: (FORCE = LB/IN, MOMENT = IN-LB/IN, STRESS = PSI)

NODE	X-COORD Y-COORD	X-DISP. Y-DISP.	N-PRES. S-PRES.	MOMENT THRUST	MAX-STRESS HOOP-STRESS	SHEAR S-STRESS
1	-254.12 0.00	-0.350E+00 -0.248E+01	-0.803E+01 0.142E+01	0.986E-10 -0.277E+04	-0.922E+04 -0.922E+04	0.140E+03 0.466E+03
2	-258.50 24.26	-0.198E+00 -0.246E+01	-0.819E+01 0.198E+01	-0.279E+04 -0.273E+04	-0.165E+05 -0.908E+04	0.835E+02 0.278E+03
3	-260.57 48.82	-0.263E-02 -0.245E+01	-0.834E+01 0.254E+01	-0.418E+04 -0.267E+04	-0.201E+05 -0.890E+04	0.319E+02 0.106E+03
4	-260.31 73.47	0.259E+00 -0.246E+01	-0.797E+01 0.240E+01	-0.437E+04 -0.261E+04	-0.204E+05 -0.869E+04	-0.169E+02 -0.563E+02
5	-257.73 97.98	0.588E+00 -0.250E+01	-0.764E+01 0.228E+01	-0.329E+04 -0.255E+04	-0.173E+05 -0.848E+04	-0.681E+02 -0.227E+03
6	-252.84 122.14	0.961E+00 -0.259E+01	-0.780E+01 0.227E+01	-0.899E+03 -0.248E+04	-0.107E+05 -0.826E+04	-0.115E+03 -0.383E+03
7	-245.70 145.73	0.134E+01 -0.271E+01	-0.866E+01 0.245E+01	0.253E+04 -0.241E+04	-0.148E+05 -0.802E+04	-0.143E+03 -0.475E+03
8	-236.35 168.54	0.166E+01 -0.285E+01	-0.102E+02 0.282E+01	0.629E+04 -0.233E+04	-0.246E+05 -0.775E+04	-0.133E+03 -0.444E+03
9	-224.90 190.36	0.187E+01 -0.298E+01	-0.105E+02 0.293E+01	0.925E+04 -0.224E+04	-0.322E+05 -0.747E+04	-0.935E+02 -0.311E+03
10	-211.44 211.01	0.195E+01 -0.303E+01	-0.111E+02 0.320E+01	0.110E+05 -0.216E+04	-0.367E+05 -0.720E+04	-0.345E+02 -0.115E+03
11	-196.08 230.29	0.189E+01 -0.299E+01	-0.875E+01 0.254E+01	0.110E+05 -0.209E+04	-0.365E+05 -0.695E+04	0.106E+02 0.354E+02
12	-178.98 248.04	0.169E+01 -0.281E+01	-0.925E+01 0.278E+01	0.106E+05 -0.202E+04	-0.349E+05 -0.674E+04	0.396E+02 0.132E+03
13	-160.27 264.09	0.140E+01 -0.249E+01	-0.103E+02 0.323E+01	0.909E+04 -0.195E+04	-0.308E+05 -0.650E+04	0.944E+02 0.314E+03
14	-140.14 278.31	0.105E+01 -0.202E+01	-0.903E+01 0.291E+01	0.584E+04 -0.189E+04	-0.219E+05 -0.629E+04	0.153E+03 0.510E+03

15	-118.75 290.56	0.706E+00 -0.143E+01	-0.746E+01 0.247E+01	0.142E+04 -0.184E+04	-0.991E+04 -0.612E+04	0.182E+03 0.606E+03
16	-96.30 300.73	0.403E+00 -0.802E+00	-0.628E+01 0.167E+01	-0.333E+04 -0.180E+04	-0.149E+05 -0.600E+04	0.181E+03 0.604E+03
17	-72.98 308.74	0.181E+00 -0.195E+00	-0.543E+01 0.937E+00	-0.775E+04 -0.179E+04	-0.267E+05 -0.594E+04	0.158E+03 0.527E+03
18	-49.02 314.51	0.496E-01 0.307E+00	-0.489E+01 0.816E+00	-0.114E+05 -0.178E+04	-0.363E+05 -0.591E+04	0.119E+03 0.396E+03
19	-24.62 318.00	-0.420E-02 0.635E+00	-0.410E+01 0.729E+00	-0.138E+05 -0.177E+04	-0.428E+05 -0.588E+04	0.646E+02 0.215E+03
20	0.00 319.17	-0.140E-01 0.742E+00	-0.374E+01 -0.477E-01	-0.146E+05 -0.176E+04	-0.440E+05 -0.586E+04	-0.338E+01 -0.113E+02
21	24.62 318.00	-0.252E-01 0.610E+00	-0.413E+01 -0.736E+00	-0.136E+05 -0.177E+04	-0.423E+05 -0.588E+04	-0.710E+02 -0.237E+03
22	49.02 314.51	-0.824E-01 0.260E+00	-0.490E+01 -0.813E+00	-0.110E+05 -0.178E+04	-0.354E+05 -0.591E+04	-0.125E+03 -0.417E+03
23	72.98 308.74	-0.218E+00 -0.258E+00	-0.549E+01 -0.967E+00	-0.727E+04 -0.178E+04	-0.254E+05 -0.594E+04	-0.163E+03 -0.544E+03
24	96.30 300.73	-0.443E+00 -0.873E+00	-0.643E+01 -0.177E+01	-0.274E+04 -0.180E+04	-0.133E+05 -0.600E+04	-0.184E+03 -0.613E+03
25	118.75 290.56	-0.745E+00 -0.150E+01	-0.765E+01 -0.252E+01	0.203E+04 -0.184E+04	-0.116E+05 -0.613E+04	-0.181E+03 -0.602E+03
26	140.14 278.31	-0.109E+01 -0.208E+01	-0.919E+01 -0.295E+01	0.637E+04 -0.189E+04	-0.233E+05 -0.630E+04	-0.148E+03 -0.493E+03
27	160.27 264.09	-0.142E+01 -0.253E+01	-0.107E+02 -0.333E+01	0.945E+04 -0.196E+04	-0.318E+05 -0.653E+04	-0.835E+02 -0.278E+03
28	178.98 248.04	-0.170E+01 -0.284E+01	-0.928E+01 -0.278E+01	0.105E+05 -0.203E+04	-0.349E+05 -0.677E+04	-0.248E+02 -0.825E+02
29	196.08 230.29	-0.187E+01 -0.300E+01	-0.845E+01 -0.244E+01	0.107E+05 -0.210E+04	-0.355E+05 -0.698E+04	0.106E-01 0.352E-01

30	211.44 211.01	-0.193E+01 -0.303E+01	-0.107E+02 -0.308E+01	0.105E+05 -0.217E+04	-0.352E+05 -0.722E+04	0.356E+02 0.119E+03
31	224.90 190.36	-0.184E+01 -0.297E+01	-0.104E+02 -0.290E+01	0.879E+04 -0.225E+04	-0.310E+05 -0.749E+04	0.879E+02 0.293E+03
32	236.35 168.54	-0.162E+01 -0.285E+01	-0.102E+02 -0.284E+01	0.601E+04 -0.233E+04	-0.238E+05 -0.777E+04	0.127E+03 0.422E+03
33	245.70 145.73	-0.130E+01 -0.271E+01	-0.877E+01 -0.249E+01	0.240E+04 -0.241E+04	-0.145E+05 -0.803E+04	0.137E+03 0.458E+03
34	252.84 122.14	-0.929E+00 -0.258E+01	-0.790E+01 -0.231E+01	-0.929E+03 -0.249E+04	-0.108E+05 -0.828E+04	0.112E+03 0.373E+03
35	257.73 97.98	-0.561E+00 -0.250E+01	-0.777E+01 -0.231E+01	-0.327E+04 -0.255E+04	-0.172E+05 -0.850E+04	0.674E+02 0.224E+03
36	260.31 73.47	-0.237E+00 -0.246E+01	-0.805E+01 -0.243E+01	-0.436E+04 -0.262E+04	-0.204E+05 -0.872E+04	0.181E+02 0.601E+02
37	260.57 48.82	0.196E-01 -0.245E+01	-0.834E+01 -0.253E+01	-0.421E+04 -0.268E+04	-0.202E+05 -0.893E+04	-0.305E+02 -0.101E+03
38	258.50 24.26	0.210E+00 -0.245E+01	-0.807E+01 -0.190E+01	-0.285E+04 -0.273E+04	-0.167E+05 -0.910E+04	-0.842E+02 -0.280E+03
39	254.12 0.00	0.355E+00 -0.247E+01	-0.781E+01 -0.127E+01	-0.290E-10 -0.277E+04	-0.923E+04 -0.923E+04	-0.144E+03 -0.479E+03

Appendix F: Improvement Costs

Briargate Bridge at Sand Creek at Sterling Ranch
Opinion of Cost

Table 1: Opinion of Cost - 2022 Proposed Public Improvements

Item	Quantity	Unit	Unit Cost	Item Total
Bridge Improvements				
Bridge Crossing, 58S Bridgecor Conspan Arch, 43ft Span	1	LS	\$ 750,000	\$ 750,000
Contingency 10%				<u>\$ 75,000</u>
Total				<u>\$ 825,000</u>
Drainage Improvements				
Handrail	637	LF	\$ 130	\$ 82,810
30" Grouted Boulders	1,450	CY	\$ 275	\$ 398,750
30" to 36" Grouted Boulders	24	CY	\$ 375	\$ 9,000
Grout Cutoff Wall	250	LF	\$ 140	\$ 35,000
Type M Soil Riprap, d50=12"	980	CY	\$ 85	\$ 83,300
Type M Void-Filled Riprap, d50=12"	740	CY	\$ 100	\$ 74,000
Concrete Grade Control Structure	38	CY	\$ 800	\$ 30,400
Seeding and Mulch	0.5	AC	\$ 1,600	\$ 800
Subtotal				\$ 714,060
Contingency 10%				<u>\$ 71,406</u>
Total				<u>\$ 785,466</u>
Bridge and Drainage Improvements Total Cost				\$ 1,610,466

**Briargate Bridge at Sand Creek at Sterling Ranch
Cost Comparison**

Table 2: Proposed Public Improvements 1996 DBPS vs 2022 Design Cost Comparison

Item	Quantity	Unit	Unit Cost	Item Total
Bridge Improvements				
2022 Bridge Crossing, 58S Bridgecor Conspan Arch, 43ft Span ¹	1	LS	\$ 825,000	\$ 825,000
1996 DBPS (4) 10'Wx8'H CBC ²	1	LS	\$ 292,282	\$ 292,282
Drainage Improvements				
2022 Drop Structures and Channel Improvements ¹	630	LF	\$ 1,247	\$ 785,466
1996 DBPS Check Structures ²	2	LS	\$ 33,725	\$ 67,450
2022 Design Total Cost				\$ 1,610,466
1996 DBPS Total Costs ²				\$ 359,731
			Difference	<u>\$ 1,250,735</u>

¹ See Table 1 cost details

² 1996 DBPS dollars adjusted to 2022 (x 2.342)

Briargate Bridge at Sand Creek at Sterling Ranch
Cost Comparison

El Paso County Drainage Basin Fee Increases

Year	Increase Amount	Resolution	Reception #	
1996	4% (effectively none to 1999)	96-60	096025092	
1997	None (effectively to 1999)			
1998	None (effectively to 1999)			
1999	New /imp ac Setup	99-383	099175333	1.000
2000	4.00%	02-80	202038189	1.040
2001	None	N/A		1.040
2002	7.00%	02-52		1.113
2003	3.00%	03-34	203016420	1.146
2004	3.00%	04-41	204020181	1.181
2005	5.00%			1.240
2006	4.00%	06-31	206018243	1.289
2007	10.00%	07-57	207020477	1.418
2008	None	N/A		1.418
2009	6.00%	09-23	209006307	1.503
2010	None	N/A		1.503
2011	None	N/A		1.503
2012	6.00%	11-449	211129092	1.593
2013	None	N/A		1.593
2014	4.30%		214028996	1.662
2015	None	N/A	215109527	1.662
2016	4.80%		216031430	1.742
2017	3.50%		217021072	1.803
2018	5.70%	17-348	217150646	1.905
2019	6.70%	18-470	218142446	2.033
2020	4.0%	19-441	219156065	2.114
2021	3.5%	20-424	220200117	2.188
2022	7.0%	21-468	221224001	2.342

SAND CREEK DISTRICT
BASIN PLANNING
PRELIMINARY DESIGN

Project No	90-04-09
Date:	11/92
Design:	RNW
Drawn:	EAK
Check:	RNW
Revisions:	

52

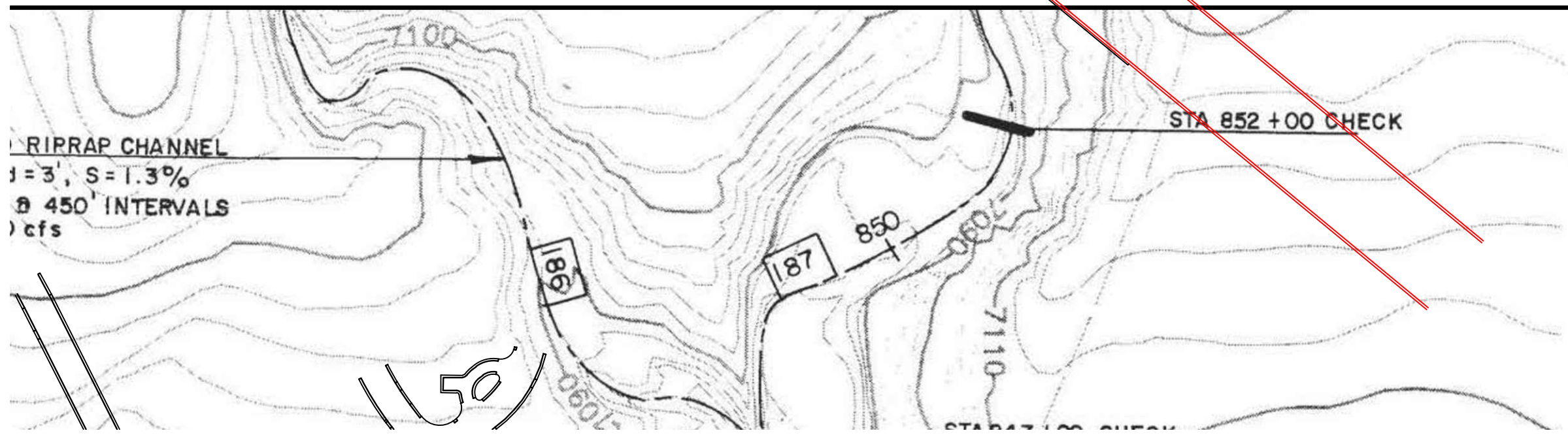
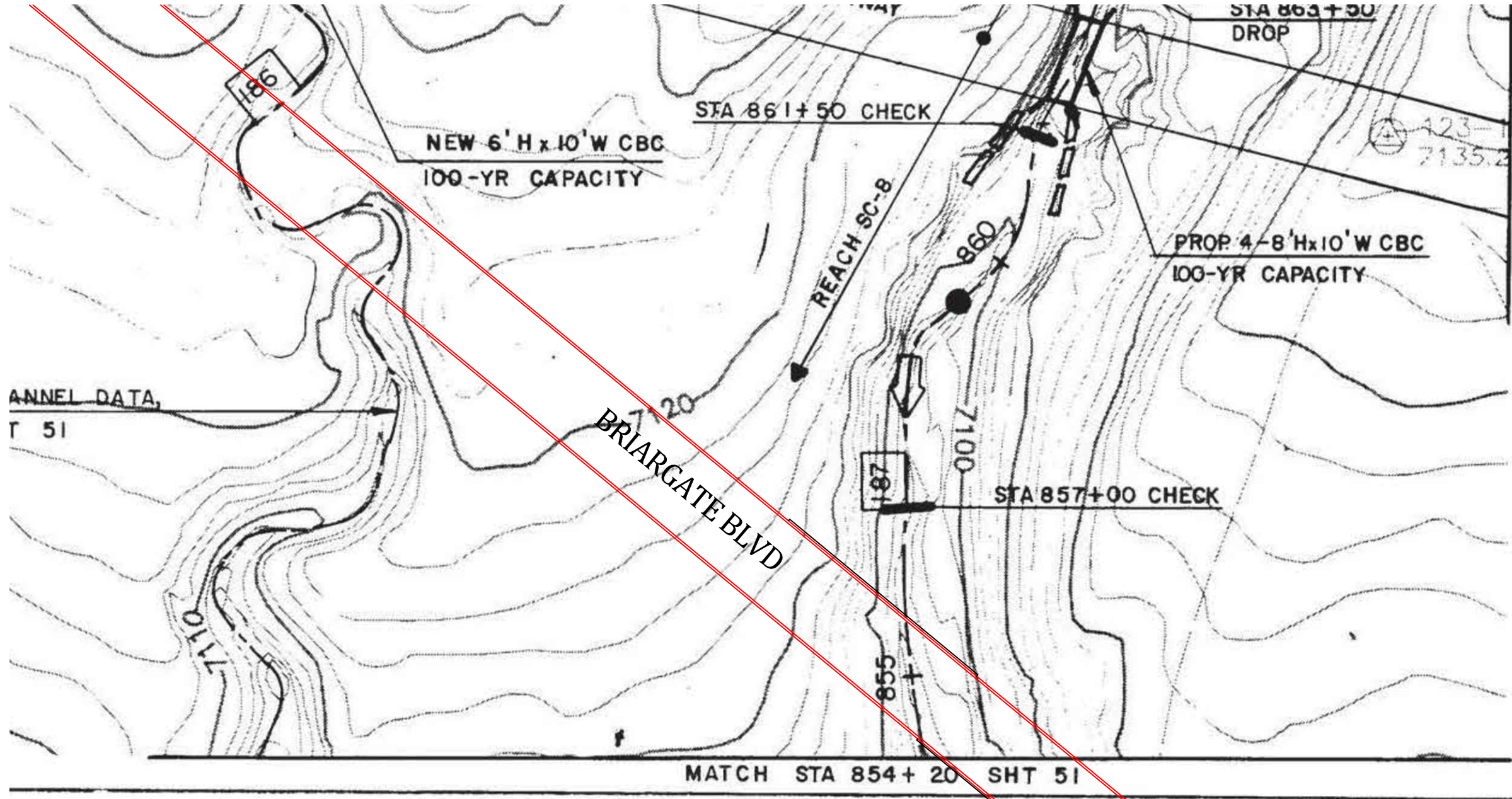

Engineering Corporat
W. Bijou Street
ado Springs, Colorado
05-1308

Table VIII-7:

SAND CREEK DRAINAGE BASIN PLANNING STUDY
BRIDGE CROSSING COST ESTIMATE
SAND CREEK DRAINAGE BASINS

ROADWAY	REACH NUMBER	DRAINAGEWAY SEGMENT	CROSSING TYPE	JURISDICTION		SIZE	UNIT	UNIT COST	TOTAL COST COUNTY	TOTAL COST CITY
				CITY	COUNTY					
SAND CREEK										
CHELTON ROAD	SC-1	115	210' TWO-SPAN BRIDGE	X		16800	SF	\$80	\$0	\$1,344,000
STETSON HILLS BLVD.	SC-6	130	3- 8'Hx10'W CBC	X		200	LF	\$1,110	\$0	\$222,000
JEDEDIAH SMITH RD.	SC-6	137	3- 8'Hx10'W CBC	X		60	LF	\$1,110	\$0	\$66,600
PETERSON ROAD	SC-6	141	80' CLEAR SPAN BRIDGE	X		6400	SF	\$80	\$0	\$512,000
DUBLIN BOULEVARD	SC-7	141	80' CLEAR SPAN BRIDGE	X		6400	SF	\$80	\$0	\$512,000
MARKSHEFFEL ROAD	SC-8	151	3- 10'Hx10'W CBC		X	80	LF	\$1,260	\$100,800	\$0
RESEARCH PARKWAY	SC-8	163	4- 8'Hx10'W CBC		X	80	LF	\$1,560	\$124,800	\$0
BANNING-LEWIS PRKWY	SC-8	187	4- 8'Hx10'W CBC		X	80	LF	\$1,560	\$124,800	\$0
CENTER TRIBUTARY										
W. FRONTAGE ROAD	CT-1	142	3- 6'Hx16'W CBC		X	60	LF	\$1,770	\$106,200	\$0
US 24 BYPASS	CT-1	142	3- 6'Hx14'W CBC		X	150	LF	\$1,410	\$211,500	\$0
E. FRONTAGE RD, US 24	CT-1	142	3- 6'Hx14'W CBC		X	60	LF	\$1,410	\$84,600	\$0
BIJOU STREET, US 24	CT-1	142	3- 6'Hx14'W CBC		X	60	LF	\$1,410	\$84,600	\$0
PLATTE AVENUE, US 24	CT-2	142	3- 6'Hx14'W CBC		X	120	LF	\$1,410	\$169,200	\$0
GALLEY ROAD	CT-4	144	3- 5'Hx8'W CBC		X	100	LF	\$900	\$90,000	\$0
WEST FORK SAND CREEK										
GALLEY ROAD	WF-2	155	54' CLEAR SPAN BRIDGE	X		5130	SF	\$80	\$0	\$410,400
PALMER PARK BLVD.	WF-2	156	54' CLEAR SPAN BRIDGE	X		5130	SF	\$80	\$0	\$410,400
CONSTITUTION AVE.	WF-3	159	40' CLEAR SPAN BRIDGE	X		3200	SF	\$80	\$0	\$256,000
MAIZELAND ROAD	WF-3	170	30' CLEAR SPAN BRIDGE	X		2400	SF	\$80	\$0	\$192,000
SO. CAREFREE	WF-3	170	2- 6'Hx15'W CBC	X		80	LF	\$1,200	\$0	\$96,000
TOTAL BRIDGE CONSTRUCTION COSTS, SAND CREEK									\$1,096,500	\$4,021,400

TABLE VIII-2: SAND CREEK DRAINAGE BASIN PLANNING STUDY
DRAINAGEWAY CONVEYANCE COST ESTIMATE
WITH SELECTED DETENTION ALTERNATIVES

SEGMENT NUMBER	REACH NUMBER	SEGMENT LENGTH (FT)	IMPROVEMENT TYPE	IMP. LENGTH (FT)	UNIT COST (\$/LF)	NUMBER OF GRADE CONTROLS	GRADE CONTROL LENGTH (FT)	TOTAL REIMBURSABL COSTS	TOTAL COST
148-2	"	2600	"	2150	127	5	620	\$384,650	\$384,650
151	SC-8	1700	10-YEAR RIPRAP	500	238	3	250	\$164,000	\$164,000
160	"	5100	SEL. LININGS (1 SIDE) 10-YR RIPRAP	4400 600	127 238	6 0	720 0	\$688,400 \$142,800	\$688,400 \$142,800
163	"	6300	SEL. LININGS (1 SIDE) 10-YR RIPRAP	2600 350	127 238	15 0	1200 0	\$546,200 \$83,300	\$546,200 \$83,300
187	"	1200	SEL. LININGS (1 SIDE)	0	0	2	160	\$28,800	\$28,800
170	SC-9	3200	"	0	0	4	320	\$57,600	\$57,600
171	"	5000	"	0	0	2	170	\$30,600	\$30,600
172	"	3650	"	0	0	2	150	\$27,000	\$27,000
TOTAL SAND CREEK DRAINAGEWAY								\$15,560,220	\$18,279,420