

EPC STORMWATER REVIEW COMMENTS
IN ORANGE BOXES WITH BLACK TEXT



**STORMWATER MANAGEMENT PLAN
FOR
TAMLIN ROAD RV
STORAGE-EXPANSION,
EL PASO COUNTY, COLORADO**

September 2024

Item Numbers refer to SWMP Checklist

Item 1. Add Qualified Stormwater Manager and Contractor Information to cover/title sheet. If unknown, add a placeholder to be updated prior to the pre-construction meeting:

QUALIFIED STORMWATER MANAGER

Name: _____
Company: _____
Address: _____

CONTRACTOR

Name: _____
Company: _____
Address: _____

Prepared For:

**Parker Samelson
Tamlin Storage, LLC
57 Newport Circle Unit B
Colorado Springs, CO 80906
(719) 659-7126**

Prepared By:

**JR ENGINEERING
5475 Tech Center Drive
Colorado Springs, CO 80906
(719) 570-7474**

Job No. 25305.00

PCD File No.: TBD **PPR2437**

ENGINEER OF RECORD:

The Stormwater Management Plan was prepared under my direction and supervision and is correct to the best of my knowledge and belief. Said Plan has been prepared according to the criteria established by the County and State for Stormwater Management Plans.

Bryan T. Law, P.E.

Date

Registered Professional Engineer

State of Colorado No. 25043

For and on behalf of JR Engineering, LLC.

TABLE OF CONTENTS

1.	Applicant / Contact Information.....	1
2.	Site Description and Location.....	1
3.	Proposed Sequence of Major Activities.....	3
4.	BMPs for Stormwater Pollution Prevention.....	4
5.	Final Stabilization and Long-Term Stormwater Management.....	6
6.	Inspection and Maintenance.....	7

Appendices

A. Vicinity Map

B. FEMA and Soils Map

C. GEC Plans and Details

D. Inspection Report Template

1. Applicant / Contact Information

- Owner/Developer:** Tamlin Storage, LLC
57 Newport Circle Unit B
Colorado Springs, CO 80906
Attn: Parker Samelson
(719) 659-7126
- Engineer:** JR Engineering, LLC
5475 Tech Center Drive, Suite 235
Colorado Springs, CO 80919
Attn: Bryan Law (303) 267-6254
blaw@jrengineering.com
- SWMP Administrator:** To be Determined
- Contractor:** To be Determined

2. Site Description and Location

Tamlin Road Storage LLC. is currently vacant land located in a portion of section 20, Township 13 South, Range 65 West of the sixth Principal Meridian in unincorporated El Paso County, Colorado. The site is located northeast of Tamlin Road and Marksheffel Road intersection. This site is bound by existing Tamlin Road to the west and north, existing Tamlin Storage to the east, and vacant land owned by BLH No. 2, LLC to the to the south. A vicinity map has been presented in Appendix A.

The site is approximately 3.45 acres and is covered in native vegetation. There are no existing structures on the site.

Site details:

- a. Total site area: 3.45 acres
Estimated area to undergo disturbance: 2.87 acres
- b. Soil Type: Per a NRCS web soil survey of the area, the site is made up of Hydrologic Group A soils. Type A soils exhibit a high infiltration rate when thoroughly wet and consist chiefly of deep, well drained to excessively drained gravelly sands. A NCRS survey map is presented in Appendix B.
- c. Soil erosion potential and potential impacts upon discharge:**
 - i. Conduct land-disturbing activities in a manner that effectively reduces accelerated soil erosion and reduces sediment movement and deposition off site.
 - ii. Schedule construction activities to minimize the total amount of soil exposed at any given time.
 - iii. Establish temporary or permanent cover on areas that have been disturbed

Item 8. Update to include soil erosion potential and impacts on discharge. Current discussion only includes procedures to reduce erosion.

as soon as practical after grading is completed.

- iv. Design and construct temporary or permanent facilities to limit the flow of water to non-erosive velocities for the conveyance of water around, through or from the disturbed area.
- v. Remove sediment caused by accelerated soil erosion from surface runoff water before it leaves the site.
- vi. Stabilize disturbed areas with permanent vegetative cover and provide permanent storm water quality control measures for the post-construction condition.

Item 10. Disturbed soils should be included as a potential pollution source.

d. Existing vegetation: Native meadow grasses (approximately 95 coverage) per aerial

e. **Location and description of potential pollution sources:** Potential sources of pollution include: Onsite waste management, portable toilets, onsite vehicle fueling, and outdoor storage, vehicle tracking pads, dust management, and temporary stock pile. The locations of these sources are shown in the GEC plans in Appendix C or will be determined by the contractor.

i. Non-industrial waste sources such as worker trash and portable toilets – Clean up litter and debris from the construction site daily and worker trash receptacles will be located by entrance/exit for easy removal/replace access. All portable toilets should be kept a minimum of 50 feet from a storm drain inlet or drainage course and secured to the ground. Toilets will be cleaned regularly and inspected daily for any spills or leaks. Waste disposal bins will be reasonably maintained at regular intervals to check for leaks and overflow capacity, and will be emptied routinely to prevent overflow.

ii. Routine maintenance activities involving fertilizers, pesticides, detergents, fuels, solvents, oils, etc. – oil, grease, coolants, etc. that leak onto the soil or impervious surface should be cleaned up as soon as possible and on-site personnel notified.

iii. Vehicle, equipment maintenance, and fueling – all designated fueling and maintenance areas shall be located a minimum of 100 feet from any drainage course whenever possible. If the fueling area is located on a pervious surface, the area shall be covered with a non-pervious lining so as to prevent soil contamination by way of infiltration. Any spillage shall be cleaned up immediately.

iv. Raw materials, intermediate products, byproducts, process residuals, Finished products, containers, and materials storage areas can be sources of pollutants such as metals, oils and grease, sediment and other contaminants. Where practical, conduct operations indoors. Where impractical, select an appropriate temporary or permanent covering to reduce exposure of materials to rainfall and runoff.

v. Vehicle tracking controls (VTC) provide stabilized construction site access where vehicles exit the site onto paved public roads. An effective vehicle tracking control helps remove sediment (mud or dirt) from vehicles, reducing tracking onto the paved surface. With aggregate vehicle tracking controls, ensure rock and debris from this area do not enter the public right-of-way. Inspect the VTC for degradation and replace aggregate or material used for a stabilized entrance/exit as needed.

Item 10. Vehicle tracking pads and dust management are types of control measures, not types of pollution sources.

- vi. Wind erosion and dust control BMPs help to keep soil particles from entering the air as a result of land disturbing construction activities. Dust control measures should be used on any site where dust poses a problem to air quality. Dust control is important to control for the health of construction workers and surrounding waterbodies.
- vii. Stockpile management should be used when soils or other erodible materials are stored at the construction site. Special attention should be given to stockpiles in close proximity to natural or manmade storm systems. Soils stockpiled for an extended period (typically for more than 30 days) mulched with a temporary grass cover once the stockpile is placed (typically within 21 days). An area that will remain in an interim state for over 60 days must also be seeded. Use of mulch only or a soil binder is acceptable if the stockpile will be in place for a more limited time period (typically 30-60 days). Refer to DCM Vol 2 – Section 3.2- General principles - Basic Grading, Erosion and Stormwater Quality Requirements and General Prohibitions #16 for more information.
- f. Spill prevention and pollution controls for dedicated batch plants: Not applicable for this site since there will be no dedicated batch plants.
- g. Street sweeping or vacuuming should be conducted when there is noticeable sediment accumulation on roadways adjacent to the construction site. Typically, this will be concentrated at the entrance/exit to the construction site. Well-maintained stabilized construction entrances and vehicle tracking controls can help reduce the necessary frequency of street sweeping and vacuuming.
- h. Location and description of **anticipated non-stormwater components of discharge:** There will be a concrete washout area (CWA) where the cleaning of concrete trucks could produce a non-stormwater discharge. Proper installation and maintenance of the CWA will not allow runoff from this area. Another potential source of non-stormwater discharge could be the irrigation of permanent seeding (PS). Irrigation will be kept at a rate so as to not create runoff.
- i. Existing basin drainage patterns are in the southwest direction.
- j. Receiving water: Runoff from the project will be treated and released through an outlet structure pipe that will direct the water into Fountain Creek.
- k. There are no streams that cross the project site.

Item 14. Should read: "anticipated allowable non-stormwater discharges: "

3. Proposed Sequence of Major Activities

The project will follow standard construction sequences for construction, i.e., clearing and grubbing, over excavation, over lot grading, utility installation, and street paving. The contractor will be responsible for implementing and maintaining the erosion and sediment control measures described in this document and the accompanying design drawings. The contractor may designate these tasks to certain subcontractors as they see fit, but the ultimate responsibility for implementing these controls and their proposed function at each phase of the project remains with the contractor. The order of major activities will be as follows:

1. **Install VTC and other perimeter soil erosion control measures. (Spring 2025)**

Item 5/6. Update to match BMP Phasing shown on GEC plan. Clearly define which construction tasks correspond to each phase of BMPs (initial, interim, and final) and/or phase of the project (pre-disturbance, site clearing, grading, etc) so it's clear when each BMP will be installed. See Table CP-1 in MHFD detail SM-1.

Item 5/6. Update to match BMP Phasing shown on GEC plan. Clearly define which construction tasks correspond to each phase of BMPs (initial, interim, and final) and/or phase of the project (pre-disturbance, site clearing, grading, etc) so it's clear when each BMP will be installed. See Table CP-1 in MHFD detail SM-1.

2. Clear and rough grade for improvements. (Spring 2025)
3. Excavate and install improvements including underground piping and drainage structures. (Spring 2025)
4. Fine grading and placement of gravel. (Spring 2025)
5. Place seed and mulch. (Summer 2025)
6. Clean up and final stabilization (Summer 2025)

4. BMPs for Stormwater Pollution Prevention

See GEC plans in Appendix C for BMP locations and detail sheets.

a. Erosion and Sediment Controls

i. Structural BMPs:

1. Temporary Sediment basins (TSB) to collect runoff before it enters receiving waters (initial, interim)
2. Silt fence (SF) along downstream limits of disturbed areas to filter sediment from runoff
3. Stabilized staging area (SSA) near site entrance to consolidate construction equipment in a stabilized location
4. Construction fence (CF) to identify limits of construction (LOC)
5. Vehicle tracking control (VTC) at site entrance to prevent sediment from leaving the site via vehicle tires
6. Erosion control blanket (ECB) placed on any slopes of 3:1 or greater, including the sides of sediment basins
7. Inlet protection (IP) around culvert entrances
8. Outlet protection (OP) at culvert outlets
9. Concrete washout area (CWA) to allow a controlled area for concrete trucks to be washed

ii. Non-structural BMPs:

1. Mulching (MU) to stabilize soils and promote seed growth
2. Permanent seeding (PS) to stabilize disturbed areas

b. Materials Handling and Spill Prevention

i. General Materials Handling Practices:

1. Potential pollutants shall be stored and used in a manner consistent with the manufacturer's instructions in a secure location. To the extent practical, material storage areas should not be located near storm drain inlets and should be equipped with covers, roofs, or secondary containment as required to prevent storm water from contacting stored materials. Chemicals that are not compatible shall be stored in segregated areas so that spilled materials cannot combine and react.
2. Disposal of materials shall be in accordance with the manufacturer's instructions and applicable local, state, and federal regulations.
3. Materials no longer required for construction shall be removed from the site as soon as possible.

4. Adequate garbage, construction waste, and sanitary waste handling and disposal facilities shall be provided as necessary to keep the site clear of obstruction and BMPs clear and functional. Construction waste will be emptied weekly and the sanitary porta potty will be pumped weekly. Storage bins shall be inspected weekly for damage, and that all defective containers shall be immediately replaced.
- ii. Specific Materials Handling Practices
 1. All pollutants, including waste materials and demolition debris, that occur onsite during construction shall be handled in a way that does not contaminate storm water.
 2. All chemicals including liquid products, petroleum products, water treatment chemicals, and wastes stored onsite shall be covered and protected from vandalism.
 3. Maintenance, fueling, and repair of all equipment and vehicles involving oil changes, hydraulic system drain down, degreasing operations, fuel tank drain down and removal, and other activities which may result in the accidental release of contaminants, shall be conducted under cover during wet weather and on an impervious surface to prevent release of contaminants onto the ground. Materials spilled during maintenance operations shall be cleaned up immediately and properly disposed of.
 4. Wheel wash water shall be settled and discharged onsite by infiltration.
 5. Application of agricultural chemicals, including fertilizers and pesticides, shall be conducted in a manner and at application rates that will not result in loss of chemical to storm water runoff. Follow manufacturer's recommendations for application rates and procedures.
 6. pH-modifying sources shall be managed to prevent contamination of runoff and storm water collected onsite. The most common sources of pH-modifying materials are bulk cement, cement kiln dust (CKD), fly ash, new concrete washing and curing waters, waste streams generated from concrete grinding and sawing, exposed aggregate processes, and concrete pumping and mixer washout waters.
 - iii. Spill Prevention and Response Procedures
 1. The primary objective in responding to a spill is to quickly contain the material(s) and prevent or minimize their migration into storm water runoff and conveyance systems. If the release has impacted onsite storm water, it is critical to contain the released materials onsite and prevent their release into receiving waters.
 2. Spill Response Procedures:
 - a. Notify site superintendent immediately when a spill, or the threat of a spill, is observed. The superintendent shall assess the situation and determine the appropriate

- response.
- b. If spills represent an imminent threat of escaping onsite facilities and entering the receiving waters, site personnel shall respond immediately to contain the release and notify the superintendent after the situation has stabilized.
 - c. The site superintendent, or his/her designee, shall be responsible for completing a spill reporting form and for reporting the spill to the appropriate agency.
 - d. Spill response equipment shall be inspected and maintained as necessary to replace any materials used in spill response activities.
3. Spill kits shall be on-hand at all fueling sites. Spill kit location(s) shall be reported to the SWMP administrator.
 4. Absorbent materials shall be on-hand at all fueling areas for use in containing inadvertent spills. Containers shall be on-hand at all fueling sites for disposal of used absorbents.
 5. Recommended components of spill kits include the following:
 - a. Oil absorbent pads (one bale)
 - b. Oil absorbent booms (40 feet)
 - c. 55-gallon drums (2)
 - d. 9-mil plastic bags (10)
 - e. Personal protective equipment including gloves and goggles
 6. Concrete wash water: unless confined in a pre-defined, bermed containment area, the cleaning of concrete truck delivery chutes is prohibited at the job site.
 7. Notification procedures:
 - a. In the event of an accident or spill, the SWMP administrator shall be notified.
 - b. Depending on the nature of the spill material involved, the Colorado Department of Public Health and Environment (24-hour spill reporting line: 887-518-5608), downstream water users, or other agencies may also need to be notified.
 - c. Any spill of oil which 1) violates water quality standards, 2) produces a “sheen” on a surface water, or 3) causes a sludge or emulsion, or any hazardous substance release, or hazardous waste release which exceeds the reportable quantity, must be reported immediately by telephone to the National Response Center Hotline at (800) 424-8802.

5. Final Stabilization and Long-Term Stormwater Management

- a. Permanent seeding will be provided to achieve long-term stabilization of the site.
- b. Seed Mix: Pawnee Buttes Seed Inc. – “Low Grow native Mix” or approved

- equal.
- c. Seeding Application Rate: Drill seed 0.25” to 0.5” into the soil. In small areas not accessible to a drill, hand broadcast at double the rate and rake 0.25” to 0.5” into the soil. Apply seed at the following rates:
 - i. Dryland: 20-25 lbs/acre
 - ii. Irrigated: 40 lbs/acre
 - d. Soil stabilization Practices:
 - i. Mulching Application: Apply 1-1/2 tons of certified weed free hay per acre mechanically crimped into the soil in combination with an organic mulch tackifier. On slopes and ditches requiring a blanket, the blanket shall be placed in lieu of much and mulch tackifier.
 - e. Soil Conditioning and Fertilization Requirements:
 - i. Soil conditioner, organic amendment shall be applied to all seeded areas at 3 CY / 1000 SF.
 - ii. Fertilizer shall consist of 90% fungal biomass (mycelium) and 10% potassium-magnesia with a grade of 6-1-3 or approved equal. Fertilizer shall be applied as recommended by seed supplier.
 - f. Final stabilization is reached when all soil-disturbing activities at the site have been completed, and uniform vegetative cover has been established with an individual plan density of at least 70 percent of pre-disturbance levels, or equivalent permanent, physical erosion reduction methods have been employed.
 - g. Two extended detention basins will be added to detain stormwater following storm events which will serve as flood-control as well as facilitate pollutant removal.
 - h. This project does not rely on control measures owned or operated by another entity.

6. Inspection and Maintenance

- a. Inspection Schedules:
 - i. The contractor shall inspect BMPs once every 14 days at a minimum, and immediately (within 24 hours) after any precipitation or snowmelt event that causes surface erosion (i.e. that results in storm water running across the ground), to ensure that BMPs are maintained in effective operating condition.
- b. Inspection Procedures:
 - i. Site Inspection / Observation Items:
 1. Construction site perimeter and discharge points
 2. All disturbed areas
 3. Areas used for material / waste storage that are exposed to precipitation
 4. Other areas having a significant potential for storm water pollution, such as demolition areas or concrete washout areas, or locations where vehicles enter or leave the site
 5. Erosion and sediment control measures identified in the SWMP

6. Any other structural BMPs that may require maintenance, such as secondary containment around fuel tanks, or the conditions of spill response kits.
- ii. Inspection Requirements:
 1. Determine if there is any evidence of, or potential for, pollutants entering the receiving waters.
 2. Review BMPs to determine if they still meet design and operational criteria in the SWMP, and if they continue to adequately control pollutants at the site.
 3. Upgrade and/or revise any BMPs not operating in accordance with the SWMP and update the SWMP to reflect any revisions.
 - iii. BMP Maintenance / Replacement and Failed BMPs:
 1. The contractor shall remove sediment that has been collected by perimeter controls, such as silt fence and inlet protection, on a regular basis to prevent failure of BMPs, and remove potential of sediment from being discharged from the site in the event of BMP failure.
 2. Removed sediment must be moved to an appropriate location where it will not become an additional pollutant source, and should never be placed in ditches or streams.
 3. The contractor shall update the GEC as required with any new BMPs added during the construction period.
 4. The contractor shall address BMPs that have failed or have the potential to fail without maintenance or modifications, as soon as possible, immediately in most cases, to prevent discharge of pollutants.
 - iv. Record Keeping and Documenting Inspections:
 1. The contractor shall maintain records of all inspection reports, including signed inspection logs, at the project site.
 2. The permittee shall document inspection results and maintain a record of the results for a period of 3 years following expiration or inactivation of permit coverage.
 3. Site inspection records shall include the following:
 - a. Inspection date
 - b. Name and title of personnel making the inspection
 - c. Location of discharges of sediment or other pollutants from the site
 - d. Location(s) of BMPs in need of maintenance
 - i. Location(s) of BMPs that failed to operate as designed or proved inadequate for a particular location
 - e. Location(s) where additional BMPs are needed that were not in place at the time of inspection
 - f. Deviations from the minimum inspection schedule
 4. SWMP should be viewed as a “living document” that is continuously being reviewed and modified as a part of the

overall process of evaluating and managing SW quality issues at the site. The QSM shall amend the SWMP when there is a change in design, construction, O&M of the site which would require the implantation of new or revised BMPs or if the SWMP proves to be ineffective in achieving the general objectives of controlling pollutants in SW discharges associated with construction activity or when BMPs are no long necessary and are removed.

APPENDIX A – VICINITY MAP

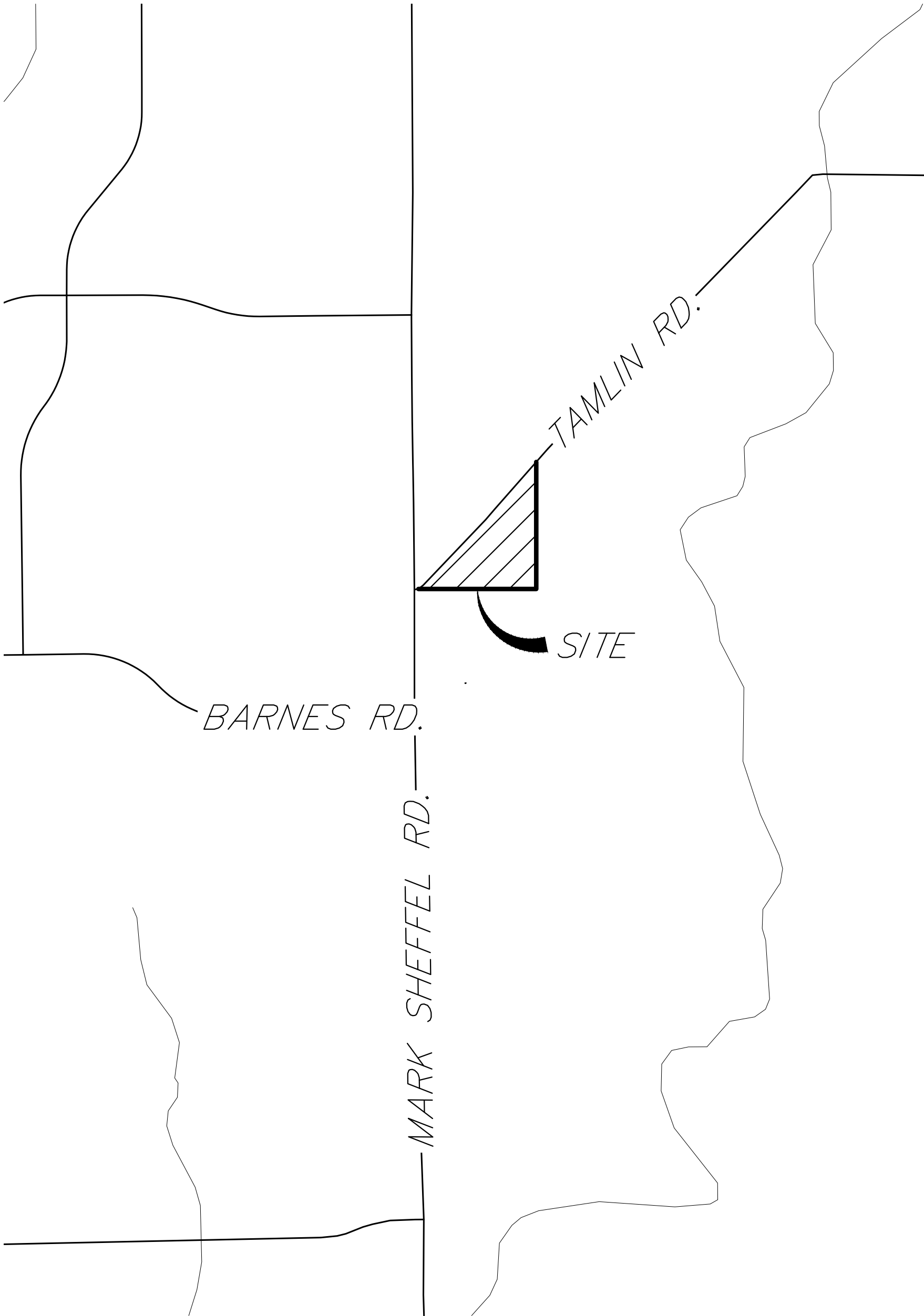

BARNES RD.

TAMLIN RD.

SITE

MARK SHEFFEL RD.

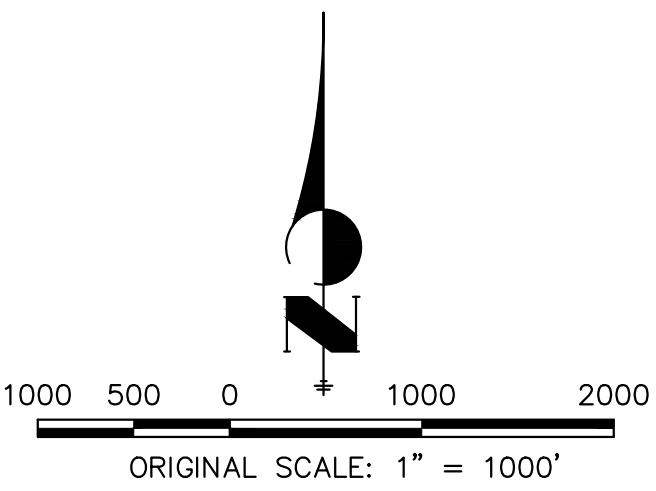

VICINITY MAP
TAMLIN STORAGE LLC.
JOB NO. 25305.00
07/29/2024
SHEET 1 OF 1

 **J-R ENGINEERING**
A Westrian Company

Centennial 303-740-9998 • Colorado Springs 719-593-2593
Fort Collins 970-491-9888 • www.jrengineering.com

APPENDIX B – FEMA AND SOILS MAP

NOTES TO USERS

This map is for use in administering the National Flood Insurance Program. It does not necessarily identify all areas subject to flooding, particularly from local drainage sources of small size. The community map repository should be consulted for possible updated or additional flood hazard information.

To obtain more detailed information in areas where **Base Flood Elevations (BFEs)** and/or **floodways** have been determined, users are encouraged to consult the Flood Profiles and Floodway Data and/or Summary of Stillwater Elevations tables contained within the Flood Insurance Study (FIS) report that accompanies this FIRM. Users should be aware that BFEs shown on the FIRM represent rounded whole-foot elevations. These BFEs are intended for flood insurance rating purposes only and should not be used as the sole source of flood elevation information. Accordingly, flood elevation data presented in the FIS report should be utilized in conjunction with the FIRM for purposes of construction and/or floodplain management.

Coastal Base Flood Elevations shown on this map apply only landward of 0.0' North American Vertical Datum of 1988 (NAVD88). Users of this FIRM should be aware that coastal flood elevations are also provided in the Summary of Stillwater Elevations table in the Flood Insurance Study report for this jurisdiction. Elevations shown in the Summary of Stillwater Elevations table should be used for construction and/or floodplain management purposes when they are higher than the elevations shown on this FIRM.

Boundaries of the **floodways** were computed at cross sections and interpolated between cross sections. The floodways were based on hydraulic considerations with regard to requirements of the National Flood Insurance Program. Floodway widths and other pertinent floodway data are provided in the Flood Insurance Study report for this jurisdiction.

Certain areas not in Special Flood Hazard Areas may be protected by **flood control structures**. Refer to section 2.4 "Flood Protection Measures" of the Flood Insurance Study report for information on flood control structures for this jurisdiction.

The **projection** used in the preparation of this map was Universal Transverse Mercator (UTM) zone 13. The **horizontal datum** was NAD83, GRS80 spheroid. Differences in datum, spheroid, projection or UTM zones zones used in the production of FIRMs for adjacent jurisdictions may result in slight positional differences in map features across jurisdiction boundaries. These differences do not affect the accuracy of this FIRM.

Flood elevations on this map are referenced to the **North American Vertical Datum of 1988 (NAVD88)**. These flood elevations must be compared to structure and ground elevations referenced to the same **vertical datum**. For information regarding conversion between the National Geodetic Vertical Datum of 1929 and the North American Vertical Datum of 1988, visit the National Geodetic Survey website at <http://www.ngs.noaa.gov/> or contact the National Geodetic Survey at the following address:

NGS Information Services
NOAA, NIMS12
National Geodetic Survey
SSMC-3, #9202
1315 East-West Highway
Silver Spring, MD 20910-3282

To obtain current elevation, description, and/or location information for **bench marks** shown on this map, please contact the Information Services Branch of the National Geodetic Survey at (301) 713-3242 or visit its website at <http://www.ngs.noaa.gov/>.

Base Map information shown on this FIRM was provided in digital format by El Paso County, Colorado State Utilities, and Anderson Consulting Engineers, Inc. These data are current as of 2008.

This map reflects more detailed and up-to-date **stream channel configurations and floodplain delineations** than those shown on the previous FIRM for this jurisdiction. The floodplains and floodways that were transferred from the previous FIRM may have been adjusted to conform to these new stream channel configurations. As a result, the Flood Profiles and Floodway Data tables in the Flood Insurance Study Report (which contains authoritative hydraulic data) may reflect stream channel distances that differ from what is shown on this map. The profile baselines depicted on this map represent the hydraulic modeling baselines that match the flood profiles and Floodway Data Tables if applicable, in the FIS report. As a result, the profile baselines may deviate significantly from the new base map channel representation and may appear outside of the floodplain.

Corporate limits shown on this map are based on the best data available at the time of publication. Because changes due to annexations or de-annexations may have occurred after this map was published, map users should contact appropriate community officials to verify current corporate limit locations.

Please refer to the separately printed **Map Index** for an overview map of the county showing the layout of map panels; community map repository addresses; and a Listing of Communities table containing National Flood Insurance Program dates for each community as well as a listing of the panels on which each community is located.

Contact **FEMA Map Service Center (MSC)** via the FEMA Map Information eXchange (FIRM) 1-877-336-2627 for information on available products associated with this FIRM. Available products may include previously issued Letters of Map Change, a Flood Insurance Study Report, and/or digital versions of this map. The MSC may also be reached by Fax at 1-800-358-9620 and its website at <http://www.msc.fema.gov/>.

If you have **questions about this map** or questions concerning the National Flood Insurance Program in general, please call **1-877-FEMA MAP (1-877-336-2627)** or visit the FEMA website at <http://www.fema.gov/business/nfp>.

El Paso County Vertical Datum Offset Table	
Flooding Source	Vertical Datum Offset (ft)

REFER TO SECTION 3.3 OF THE EL PASO COUNTY FLOOD INSURANCE STUDY FOR STREAM BY STREAM VERTICAL DATUM CONVERSION INFORMATION

Panel Location Map

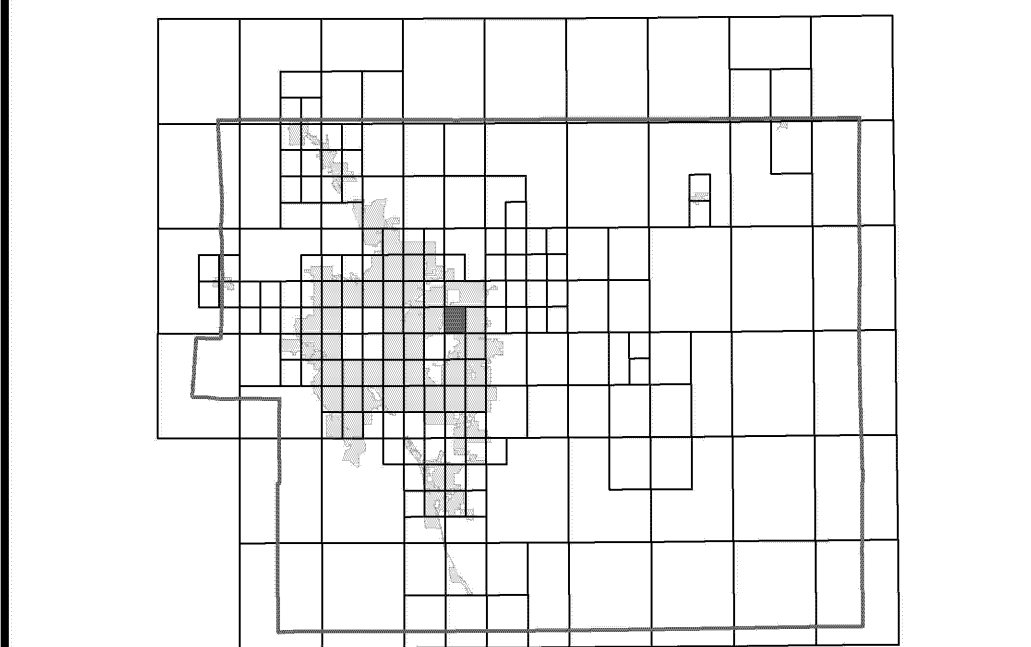

This Digital Flood Insurance Rate Map (DFIRM) was produced through a Cooperating Technical Partner (CTP) agreement between the State of Colorado Water Conservation Board (CWCB) and the Federal Emergency Management Agency (FEMA).



Additional Flood Hazard information and resources are available from local communities and the Colorado Water Conservation Board.

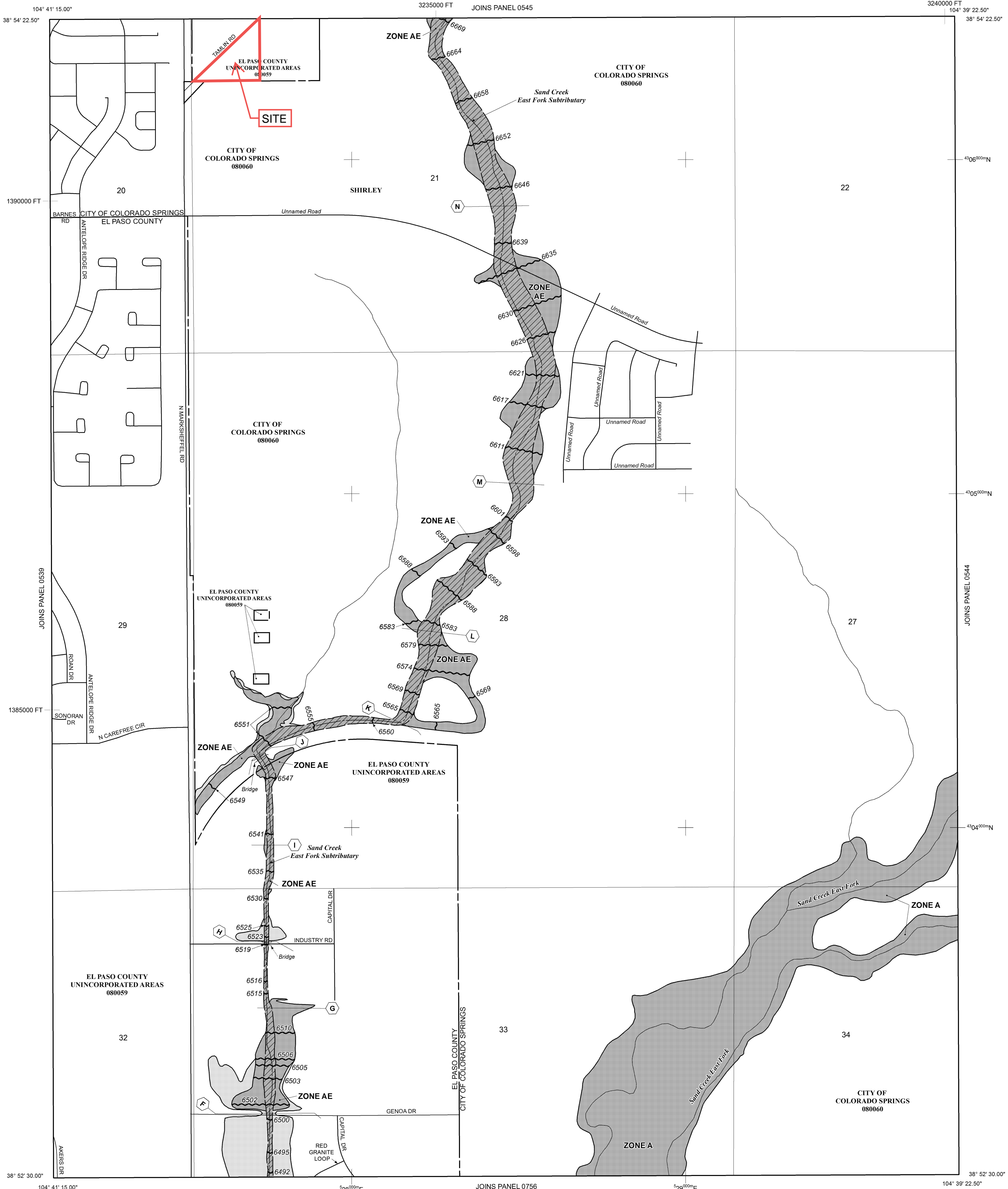

NOTE: MAP AREA SHOWN ON THIS PANEL IS LOCATED WITHIN TOWNSHIP 13 SOUTH, RANGE 65 WEST.

LEGEND

- SPECIAL FLOOD HAZARD AREAS (SFHAs) SUBJECT TO INUNDATION BY THE 1% ANNUAL CHANCE FLOOD
- The 1% annual chance flood (100-year flood), also known as the base flood, is the flood that has a 1% chance of being equalled or exceeded in any given year. The Special Flood Hazard Area is the area subject to flooding by the 1% annual chance flood. Areas of Special Flood Hazard include Zones A, AE, AH, AO, AR, A99, V, and VE. The Base Flood Elevation is the water-surface elevation of the 1% annual chance flood.
- ZONE A** No Base Flood Elevations determined.
- ZONE AE** Base Flood Elevations determined.
- ZONE AH** Flood depths of 1 to 3 feet (usually areas of ponding); Base Flood Elevations determined.
- ZONE AO** Flood depths of 1 to 3 feet (usually sheet flow on sloping terrain); average depths determined. For areas of alluvial fan flooding, velocities also determined.
- ZONE AR** Special Flood Hazard Area Formerly protected from the 1% annual chance flood by a flood control system that was subsequently decertified. Zone AR indicates that the former flood control system is being restored to provide protection from the 1% annual chance or greater flood.
- ZONE A99** Area to be protected from 1% annual chance flood by a Federal flood protection system under construction; no Base Flood Elevations determined.
- ZONE V** Coastal flood zone with velocity hazard (wave action); no Base Flood Elevations determined.
- ZONE VE** Coastal flood zone with velocity hazard (wave action); Base Flood Elevations determined.
- FLOODWAY AREAS IN ZONE AE
- The floodway is the channel of a stream plus any adjacent floodplain areas that must be kept free of encroachment so that the 1% annual chance flood can be carried without substantial increases in flood heights.
- OTHER FLOOD AREAS
- ZONE X** Areas of 0.2% annual chance flood; areas of 1% annual chance flood with average depths of less than 1 foot or with drainage areas less than 1 square mile; and areas protected by levees from 1% annual chance flood.
- OTHER AREAS
- ZONE X** Areas determined to be outside the 0.2% annual chance floodplain.
- ZONE D** Areas in which flood hazards are undetermined, but possible.
- COASTAL BARRIER RESOURCES SYSTEM (CBRS) AREAS
- OTHERWISE PROTECTED AREAS (OPAs)
- CBRS areas and OPAs are normally located within or adjacent to Special Flood Hazard Areas.
- Floodplain boundary
- Floodway boundary
- Zone D Boundary
- CBRS and OPA boundary
- Boundary dividing Special Flood Hazard Areas of different Base Flood Elevations, flood depths or flood velocities.
- Base Flood Elevation value where uniform within zone; elevation in feet* (EL 987)
- Cross section line
- Transect line
- Datum of 1983 (NAD 83)
- 1000-meter Universal Transverse Mercator grid ticks, zone 13
- 5000-foot grid ticks; Colorado State Plane coordinate system, central zone (FIPSZONE 0502), Lambert Conformal Conic Projection
- Bench mark (see explanation in Notes to Users section of this FIRM panel)
- River Mile
- MAP REPOSITORIES
Refer to Map Repositories list on Map Index
- EFFECTIVE DATE OF COUNTYWIDE FLOOD INSURANCE RATE MAP
MARCH 17, 1997
- EFFECTIVE DATE(S) OF REVISION(S) TO THIS PANEL
DECEMBER 7, 2018 - to update corporate limits, to change Base Flood Elevations and Special Flood Hazard Areas, to update map format, to add roads and road names, and to incorporate previously issued Letters of Map Revision.
- For community map revision history prior to countywide mapping, refer to the Community Map History Table located in the Flood Insurance Study report for this jurisdiction.
- To determine if flood insurance is available in this community, contact your insurance agent or call the National Flood Insurance Program at 1-800-638-6620.

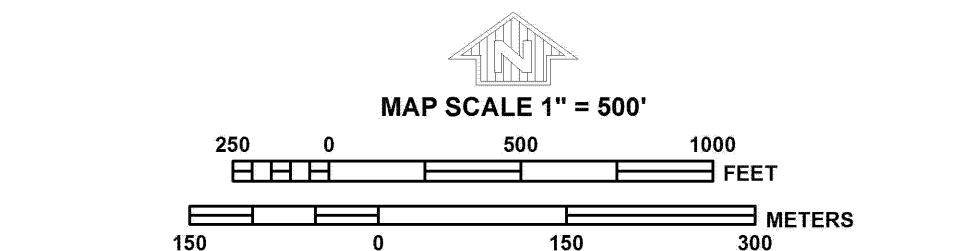

NFIP

PANEL 0543G

FIRM
FLOOD INSURANCE RATE MAP
EL PASO COUNTY,
COLORADO
AND INCORPORATED AREAS

PANEL 543 OF 1300
(SEE MAP INDEX FOR FIRM PANEL LAYOUT)

CONTAINS:

COMMUNITY	NUMBER	PANEL	SUFFIX
EL PASO COUNTY	08060	0543	G
EL PASO COUNTY	08059	0543	G

Notice to User: The Map Number shown below should be used when placing map orders. The Community Number shown above should be used on insurance applications for the subject community.

MAP NUMBER
08041C0543G

MAP REVISED
DECEMBER 7, 2018

Federal Emergency Management Agency



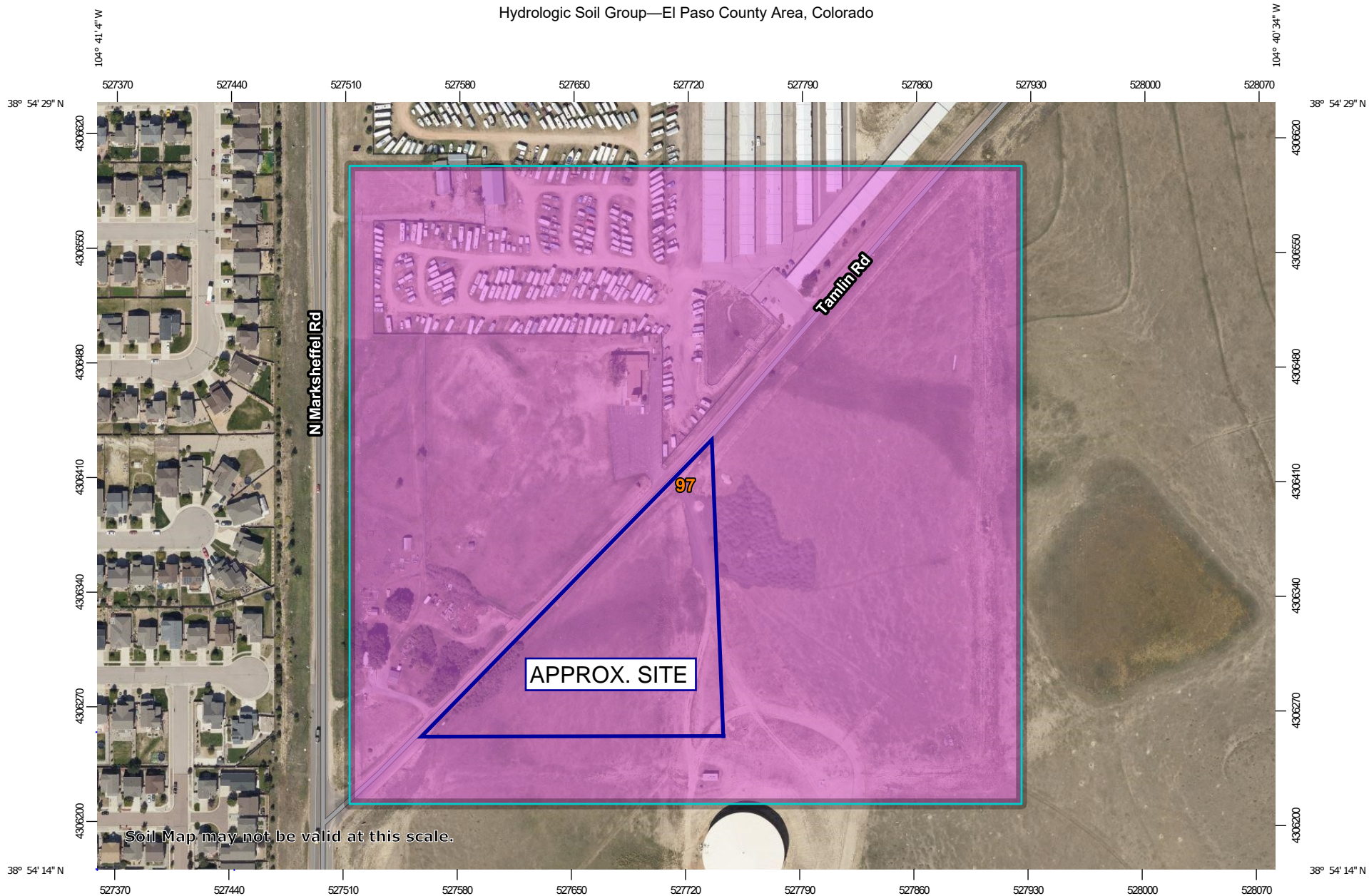



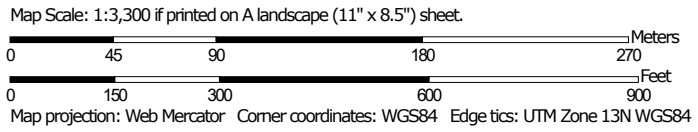

























Hydrologic Soil Group—El Paso County Area, Colorado



Soil Map may not be valid at this scale.



MAP LEGEND

- Area of Interest (AOI)**
 -  Area of Interest (AOI)
- Soils**
 - Soil Rating Polygons**
 -  A
 -  A/D
 -  B
 -  B/D
 -  C
 -  C/D
 -  D
 -  Not rated or not available
 - Soil Rating Lines**
 -  A
 -  A/D
 -  B
 -  B/D
 -  C
 -  C/D
 -  D
 -  Not rated or not available
 - Soil Rating Points**
 -  A
 -  A/D
 -  B
 -  B/D
- Water Features**
 -  Streams and Canals
- Transportation**
 -  Rails
 -  Interstate Highways
 -  US Routes
 -  Major Roads
 -  Local Roads
- Background**
 -  Aerial Photography
- Other**
 -  C
 -  C/D
 -  D
 -  Not rated or not available

MAP INFORMATION

The soil surveys that comprise your AOI were mapped at 1:24,000.

Warning: Soil Map may not be valid at this scale.
 Enlargement of maps beyond the scale of mapping can cause misunderstanding of the detail of mapping and accuracy of soil line placement. The maps do not show the small areas of contrasting soils that could have been shown at a more detailed scale.

Please rely on the bar scale on each map sheet for map measurements.

Source of Map: Natural Resources Conservation Service
 Web Soil Survey URL:
 Coordinate System: Web Mercator (EPSG:3857)

Maps from the Web Soil Survey are based on the Web Mercator projection, which preserves direction and shape but distorts distance and area. A projection that preserves area, such as the Albers equal-area conic projection, should be used if more accurate calculations of distance or area are required.

This product is generated from the USDA-NRCS certified data as of the version date(s) listed below.

Soil Survey Area: El Paso County Area, Colorado
 Survey Area Data: Version 21, Aug 24, 2023

Soil map units are labeled (as space allows) for map scales 1:50,000 or larger.

Date(s) aerial images were photographed: Aug 19, 2018—Sep 23, 2018

The orthophoto or other base map on which the soil lines were compiled and digitized probably differs from the background imagery displayed on these maps. As a result, some minor shifting of map unit boundaries may be evident.

Hydrologic Soil Group

Map unit symbol	Map unit name	Rating	Acres in AOI	Percent of AOI
97	Truckton sandy loam, 3 to 9 percent slopes	A	39.8	100.0%
Totals for Area of Interest			39.8	100.0%

Description

Hydrologic soil groups are based on estimates of runoff potential. Soils are assigned to one of four groups according to the rate of water infiltration when the soils are not protected by vegetation, are thoroughly wet, and receive precipitation from long-duration storms.

The soils in the United States are assigned to four groups (A, B, C, and D) and three dual classes (A/D, B/D, and C/D). The groups are defined as follows:

Group A. Soils having a high infiltration rate (low runoff potential) when thoroughly wet. These consist mainly of deep, well drained to excessively drained sands or gravelly sands. These soils have a high rate of water transmission.

Group B. Soils having a moderate infiltration rate when thoroughly wet. These consist chiefly of moderately deep or deep, moderately well drained or well drained soils that have moderately fine texture to moderately coarse texture. These soils have a moderate rate of water transmission.

Group C. Soils having a slow infiltration rate when thoroughly wet. These consist chiefly of soils having a layer that impedes the downward movement of water or soils of moderately fine texture or fine texture. These soils have a slow rate of water transmission.

Group D. Soils having a very slow infiltration rate (high runoff potential) when thoroughly wet. These consist chiefly of clays that have a high shrink-swell potential, soils that have a high water table, soils that have a claypan or clay layer at or near the surface, and soils that are shallow over nearly impervious material. These soils have a very slow rate of water transmission.

If a soil is assigned to a dual hydrologic group (A/D, B/D, or C/D), the first letter is for drained areas and the second is for undrained areas. Only the soils that in their natural condition are in group D are assigned to dual classes.

Rating Options

Aggregation Method: Dominant Condition

Component Percent Cutoff: None Specified

Tie-break Rule: Higher

APPENDIX C – GEC PLANS AND DETAILS

RV STORAGE PROJECT TAMLIN ROAD

5080 TAMLIN ROAD

LOCATED IN SECTION 21, TOWNSHIP13S, RANGE 65W OF THE 6TH P.M.,
COUNTY OF EL PASO, STATE OF COLORADO

GRADING AND EROSION CONTROL PLANS

SEPTEMBER 2024

GRADING AND EROSION CONTROL STANDARD NOTES

- STORMWATER DISCHARGES FROM CONSTRUCTION SITES SHALL NOT CAUSE OR THREATEN TO CAUSE POLLUTION, CONTAMINATION, OR DEGRADATION OF STATE WATERS. ALL WORK AND EARTH DISTURBANCE SHALL BE DONE IN A MANNER THAT MINIMIZES POLLUTION OF ANY ON-SITE OR OFF-SITE WATERS, INCLUDING WETLANDS.
- NOTWITHSTANDING ANYTHING DEPICTED IN THESE PLANS IN WORDS OR GRAPHIC REPRESENTATION, ALL DESIGN AND CONSTRUCTION RELATED TO ROADS, STORM DRAINAGE AND EROSION CONTROL SHALL CONFORM TO THE STANDARDS AND REQUIREMENTS OF THE MOST RECENT VERSION OF THE RELEVANT ADOPTED EL PASO COUNTY STANDARDS, INCLUDING THE LAND DEVELOPMENT CODE, THE ENGINEERING CRITERIA MANUAL, THE DRAINAGE CRITERIA MANUAL, AND THE DRAINAGE CRITERIA MANUAL VOLUME 2. ANY DEVIATIONS FROM REGULATIONS AND STANDARDS MUST BE REQUESTED, AND APPROVED, IN WRITING.
- A SEPARATE STORMWATER MANAGEMENT PLAN (SWMP) FOR THIS PROJECT SHALL BE COMPLETED AND AN EROSION AND STORMWATER QUALITY CONTROL PERMIT (ESQCP) ISSUED PRIOR TO COMMENCING CONSTRUCTION. MANAGEMENT OF THE SWMP DURING CONSTRUCTION IS THE RESPONSIBILITY OF THE DESIGNATED QUALIFIED STORMWATER MANAGER OR CERTIFIED EROSION CONTROL INSPECTOR. THE SWMP SHALL BE LOCATED ON SITE AT ALL TIMES DURING CONSTRUCTION AND SHALL BE KEPT UP TO DATE WITH WORK PROGRESS AND CHANGES IN THE FIELD.
- ONCE THE ESQCP IS APPROVED AND A NOTICE TO PROCEED HAS BEEN ISSUED, THE CONTRACTOR MAY INSTALL THE INITIAL STAGE EROSION AND SEDIMENT CONTROL MEASURES AS INDICATED ON THE APPROVED GEC. A PRECONSTRUCTION MEETING BETWEEN THE CONTRACTOR, ENGINEER, AND EL PASO COUNTY WILL BE HELD PRIOR TO ANY CONSTRUCTION. IT IS THE RESPONSIBILITY OF THE APPLICANT TO COORDINATE THE MEETING TIME AND PLACE WITH COUNTY STAFF.
- CONTROL MEASURES MUST BE INSTALLED PRIOR TO COMMENCEMENT OF ACTIVITIES THAT COULD CONTRIBUTE POLLUTANTS TO STORMWATER. CONTROL MEASURES FOR SLOPES, CHANNELS, DITCHES, AND DISTURBED LAND AREAS SHALL BE INSTALLED IMMEDIATELY UPON COMPLETION OF THE DISTURBANCE.
- ALL TEMPORARY SEDIMENT AND EROSION CONTROL MEASURES SHALL BE MAINTAINED AND REMAIN IN EFFECTIVE OPERATING CONDITION UNTIL PERMANENT SOIL EROSION CONTROL MEASURES ARE IMPLEMENTED AND FINAL STABILIZATION IS ESTABLISHED. ALL PERSONS ENGAGED IN LAND DISTURBANCE ACTIVITIES SHALL ASSESS THE ADEQUACY OF CONTROL MEASURES AT THE SITE AND IDENTIFY IF CHANGES TO THOSE CONTROL MEASURES ARE NEEDED TO ENSURE THE CONTINUED EFFECTIVE PERFORMANCE OF THE CONTROL MEASURES. ALL CHANGES TO TEMPORARY SEDIMENT AND EROSION CONTROL MEASURES MUST BE INCORPORATED INTO THE STORMWATER MANAGEMENT PLAN.
- TEMPORARY STABILIZATION SHALL BE IMPLEMENTED ON DISTURBED AREAS AND STOCKPILES WHERE GROUND DISTURBING CONSTRUCTION ACTIVITY HAS PERMANENTLY CEASED OR TEMPORARILY CEASED FOR LONGER THAN 14 DAYS.
- FINAL STABILIZATION MUST BE IMPLEMENTED AT ALL APPLICABLE CONSTRUCTION SITES. FINAL STABILIZATION IS ACHIEVED WHEN ALL GROUND DISTURBING ACTIVITIES ARE COMPLETE AND ALL DISTURBED AREAS EITHER HAVE A UNIFORM VEGETATIVE COVER WITH INDIVIDUAL PLANT DENSITY OF 70 PERCENT OF PRE-DISTURBANCE LEVELS ESTABLISHED OR EQUIVALENT PERMANENT ALTERNATIVE STABILIZATION METHOD IS IMPLEMENTED. ALL TEMPORARY SEDIMENT AND EROSION CONTROL MEASURES SHALL BE REMOVED UPON FINAL STABILIZATION AND BEFORE PERMIT CLOSURE.
- ALL PERMANENT STORMWATER MANAGEMENT FACILITIES SHALL BE INSTALLED AS DESIGNED IN THE APPROVED PLANS. ANY PROPOSED CHANGES THAT AFFECT THE DESIGN OR FUNCTION OF PERMANENT STORMWATER MANAGEMENT STRUCTURES MUST BE APPROVED BY THE ECM ADMINISTRATOR PRIOR TO IMPLEMENTATION.
- EARTH DISTURBANCES SHALL BE CONDUCTED IN SUCH A MANNER SO AS TO EFFECTIVELY MINIMIZE ACCELERATED SOIL EROSION AND RESULTING SEDIMENTATION. ALL DISTURBANCES SHALL BE DESIGNED, CONSTRUCTED, AND COMPLETED SO THAT THE EXPOSED AREA OF ANY DISTURBED LAND SHALL BE LIMITED TO THE SHORTEST PRACTICAL PERIOD OF TIME. PRE-EXISTING VEGETATION SHALL BE PROTECTED AND MAINTAINED WITHIN 50 HORIZONTAL FEET OF A WATERS OF THE STATE UNLESS SHOWN TO BE INFEASIBLE AND SPECIFICALLY REQUESTED AND APPROVED.
- COMPACTION OF SOIL MUST BE PREVENTED IN AREAS DESIGNATED FOR INFILTRATION CONTROL MEASURES OR WHERE FINAL STABILIZATION WILL BE ACHIEVED BY VEGETATIVE COVER. AREAS DESIGNATED FOR INFILTRATION CONTROL MEASURES SHALL ALSO BE PROTECTED FROM SEDIMENTATION DURING CONSTRUCTION UNTIL FINAL STABILIZATION IS ACHIEVED. IF COMPACTION PREVENTION IS NOT FEASIBLE DUE TO SITE CONSTRAINTS, ALL AREAS DESIGNATED FOR INFILTRATION AND VEGETATION CONTROL MEASURES MUST BE LOOSENEED PRIOR TO INSTALLATION OF THE CONTROL MEASURE(S).
- ANY TEMPORARY OR PERMANENT FACILITY DESIGNED AND CONSTRUCTED FOR THE CONVEYANCE OF STORMWATER AROUND, THROUGH, OR FROM THE EARTH DISTURBANCE AREA SHALL BE A STABILIZED CONVEYANCE DESIGNED TO MINIMIZE EROSION AND THE DISCHARGE OF SEDIMENT OFF SITE.
- CONCRETE WASH WATER SHALL BE CONTAINED AND DISPOSED OF IN ACCORDANCE WITH THE SWMP. NO WASH WATER SHALL BE DISCHARGED TO OR ALLOWED TO ENTER STATE WATERS, INCLUDING TO ANY SURFACE OR SUBSURFACE STORM DRAINAGE SYSTEM OR FACILITIES. CONCRETE WASHOUTS SHALL NOT BE LOCATED IN AN AREA WHERE SHALLOW GROUNDWATER MAY BE PRESENT, OR WITHIN 50 FEET OF A SURFACE WATER BODY, CREEK OR STREAM.
- DURING DEWATERING OPERATIONS OF UNCONTAMINATED GROUND WATER MAY BE DISCHARGED ON SITE, BUT SHALL NOT LEAVE THE SITE IN THE FORM OF SURFACE RUNOFF UNLESS AN APPROVED STATE DEWATERING PERMIT IS IN PLACE.
- EROSION CONTROL BLANKETING OR OTHER PROTECTIVE COVERING SHALL BE USED ON SLOPES STEEPER THAN 3:1.
- CONTRACTOR SHALL BE RESPONSIBLE FOR THE REMOVAL OF ALL WASTES FROM THE CONSTRUCTION SITE FOR DISPOSAL IN ACCORDANCE WITH LOCAL AND STATE REGULATIONS. CONSTRUCTION DEBRIS, TREE SLASH, BUILDING MATERIAL WASTES OR UNUSED BUILDING MATERIALS SHALL BE BURIED, DUMPED, OR DISCHARGED AT THE SITE.
- WASTE MATERIALS SHALL NOT BE TEMPORARILY PLACED OR STORED IN THE STREET, ALLEY, OR OTHER PUBLIC WAY, UNLESS IN ACCORDANCE WITH AN APPROVED TRAFFIC CONTROL PLAN. CONTROL MEASURES MAY BE REQUIRED BY EL PASO COUNTY ENGINEERING IF DEEMED NECESSARY, BASED ON SPECIFIC CONDITIONS AND CIRCUMSTANCES.
- TRACKING OF SOILS AND CONSTRUCTION DEBRIS OFF-SITE SHALL BE MINIMIZED. MATERIALS TRACKED OFF-SITE SHALL BE CLEANED UP AND PROPERLY DISPOSED OF IMMEDIATELY.
- THE OWNER/DEVELOPER SHALL BE RESPONSIBLE FOR THE REMOVAL OF ALL CONSTRUCTION DEBRIS, DIRT, TRASH, ROCK, SEDIMENT, SOIL, AND SAND THAT MAY ACCUMULATE IN ROADS, STORM DRAINS AND OTHER DRAINAGE CONVEYANCE SYSTEMS AND STORMWATER APPURTENANCES AS A RESULT OF SITE DEVELOPMENT.
- THE QUANTITY OF MATERIALS STORED ON THE PROJECT SITE SHALL BE LIMITED, AS MUCH AS PRACTICAL, TO THAT QUANTITY REQUIRED TO PERFORM THE WORK IN AN ORDERLY MANNER. ALL MATERIALS STORED ON-SITE SHALL BE STORED IN A NEAT, ORDERLY MANNER, IN THEIR ORIGINAL CONTAINERS, WITH ORIGINAL MANUFACTURER'S LABELS.
- NO CHEMICAL(S) HAVING THE POTENTIAL TO BE RELEASED IN STORMWATER ARE TO BE STORED OR USED ON-SITE UNLESS PERMISSION FOR THE USE OF SUCH CHEMICAL(S) IS GRANTED IN WRITING BY THE ECM ADMINISTRATOR. IN GRANTING APPROVAL FOR THE USE OF SUCH CHEMICAL(S), SPECIAL CONDITIONS AND MONITORING MAY BE REQUIRED.
- BULK STORAGE OF ALLOWED PETROLEUM PRODUCTS OR OTHER ALLOWED LIQUID CHEMICALS IN EXCESS OF 55 GALLONS SHALL REQUIRE ADEQUATE SECONDARY CONTAINMENT PROTECTION TO CONTAIN ALL SPILLS ON-SITE AND TO PREVENT ANY SPILLED MATERIALS FROM ENTERING STATE WATERS, ANY SURFACE OR SUBSURFACE STORM DRAINAGE SYSTEM OR OTHER FACILITIES.
- NO PERSON SHALL CAUSE THE IMPEDIMENT OF STORMWATER FLOW IN THE CURB AND GUTTER OR DITCH EXCEPT WITH APPROVED SEDIMENT CONTROL MEASURES.
- OWNER/DEVELOPER AND THEIR AGENTS SHALL COMPLY WITH THE "COLORADO WATER QUALITY CONTROL ACT" (TITLE 25, ARTICLE 8, CRS), AND THE "CLEAN WATER ACT" (33 USC 1344), IN ADDITION TO THE REQUIREMENTS OF THE LAND DEVELOPMENT CODE, DCM VOLUME II AND THE ECM APPENDIX I. ALL APPROPRIATE PERMITS MUST BE OBTAINED BY THE CONTRACTOR PRIOR TO CONSTRUCTION (1041, NPDES, FLOODPLAIN, 404, FUGITIVE DUST, ETC.). IN THE EVENT OF CONFLICTS BETWEEN THESE REQUIREMENTS AND OTHER LAWS, RULES, OR REGULATIONS OF OTHER FEDERAL, STATE, LOCAL, OR COUNTY AGENCIES, THE MOST RESTRICTIVE LAWS, RULES, OR REGULATIONS SHALL APPLY.
- ALL CONSTRUCTION TRAFFIC MUST ENTER/EXIT THE SITE ONLY AT APPROVED CONSTRUCTION ACCESS POINTS.
- PRIOR TO CONSTRUCTION THE PERMITTEE SHALL VERIFY THE LOCATION OF EXISTING UTILITIES.
- A WATER SOURCE SHALL BE AVAILABLE ON SITE DURING EARTHWORK OPERATIONS AND SHALL BE UTILIZED AS REQUIRED TO MINIMIZE DUST FROM EARTHWORK EQUIPMENT AND WIND.
- THE SOILS REPORT FOR THIS SITE HAS BEEN PREPARED BY XXX AND SHALL BE CONSIDERED A PART OF THESE PLANS.
- AT LEAST TEN (10) DAYS PRIOR TO THE ANTICIPATED START OF CONSTRUCTION, FOR PROJECTS THAT WILL DISTURB ONE (1) ACRE OR MORE, THE OWNER OR OPERATOR OF CONSTRUCTION ACTIVITY SHALL SUBMIT A PERMIT APPLICATION FOR STORMWATER DISCHARGE TO THE COLORADO DEPARTMENT OF PUBLIC HEALTH AND ENVIRONMENT, WATER QUALITY DIVISION. THE APPLICATION CONTAINS CERTIFICATION OF COMPLETION OF A STORMWATER MANAGEMENT PLAN (SWMP), OF WHICH THIS GRADING AND EROSION CONTROL PLAN MAY BE A PART. FOR INFORMATION OR APPLICATION MATERIALS CONTACT:
COLORADO DEPARTMENT OF PUBLIC HEALTH AND ENVIRONMENT
WATER QUALITY CONTROL DIVISION
WOOD - PERMITS
4300 CHERRY CREEK DRIVE SOUTH
DENVER, CO 80246-1530
ATTN: PERMITS UNIT

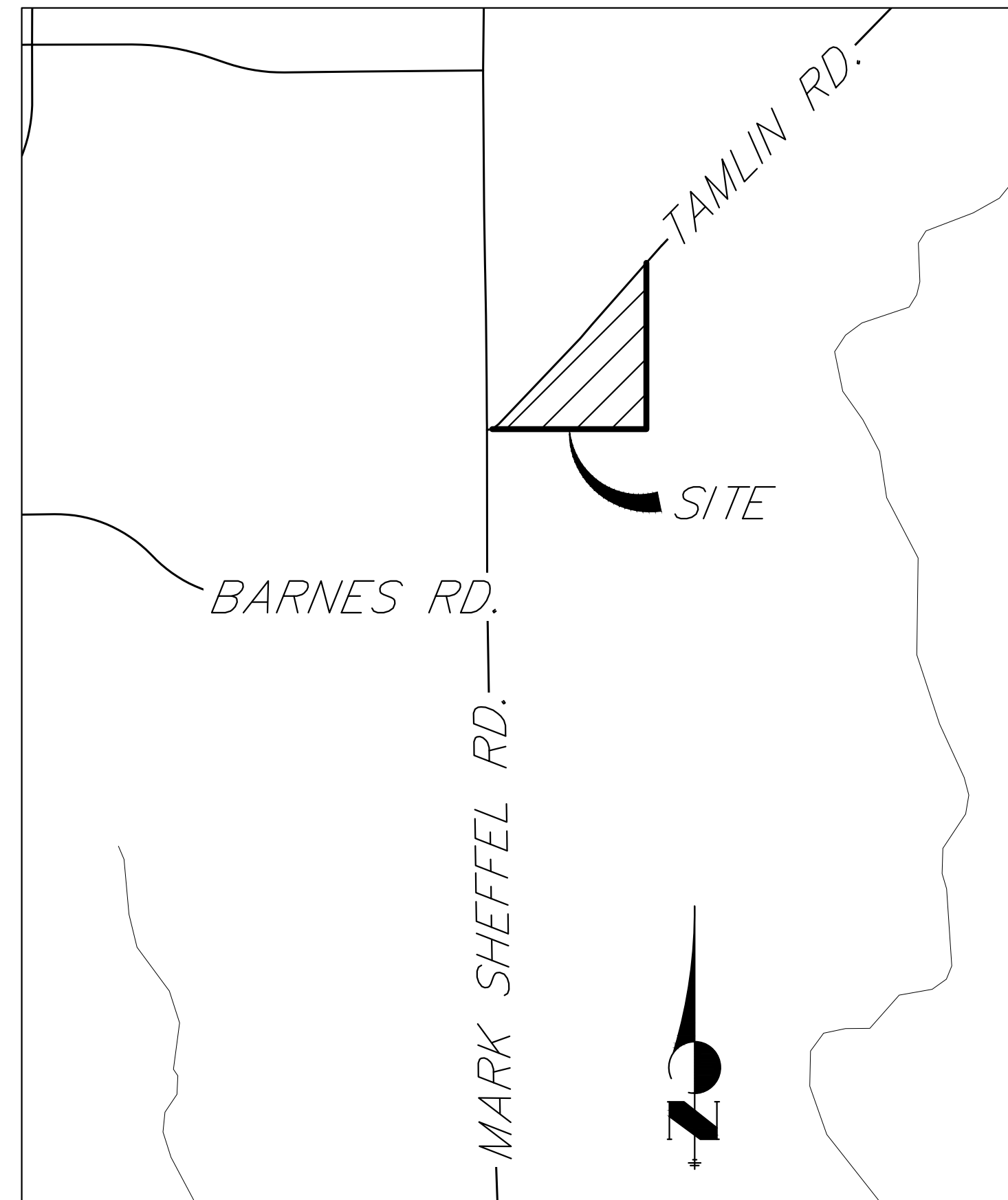

VICINITY MAP

SCALE: 1"=1000'

AGENCIES

OWNER/DEVELOPER:	TAMLIN STORAGE, LLC 57 NEWPORT CIRCLE UNIT B COLORADO SPRINGS, CO 80919 PARKER SAMELSON (719) 659-7126	FIRE DISTRICT:	FALCON FIRE PROTECTION 12072 ROYAL COUNTY DOWN ROAD FALCON, CO 80831 (719) 495-4050
CIVIL ENGINEER:	JR ENGINEERING, LLC 5475 TECH CENTER DRIVE COLORADO SPRINGS, CO 80919 BRYAN LAW P.E. (303) 267-6254	GAS DEPARTMENT:	COLORADO SPRINGS UTILITIES 7710 DURANT DR. COLORADO SPRINGS, CO 80947 (719) 668-3556
COUNTY ENGINEERING:	EL PASO COUNTY PLANNING AND COMMUNITY DEVELOPMENT 2880 INTERNATIONAL CIRCLE, SUITE 110 COLORADO SPRINGS, CO 80910 CHARLENE DURHAM, P.E. (719) 520-7951	ELECTRIC DEPARTMENT:	MOUNTAIN VIEW ELECTRIC 11140 E. WOODMAN ROAD FALCON, CO 80831 (719) 495-2283
TRAFFIC ENGINEERING:	EL PASO COUNTY DEPARTMENT OF PUBLIC WORKS 3275 AKERS DRIVE COLORADO SPRINGS, CO 80922 JOSHUA PALMER, P.E. (719) 520-6460	COMMUNICATIONS:	QUEST COMMUNICATIONS (U.N.C.G. LOCATORS) (800) 922-1987 (AT&T LOCATORS) (719) 635-3674

STANDARD NOTES FOR EL PASO COUNTY CONSTRUCTION PLANS

- ALL DRAINAGE AND ROADWAY CONSTRUCTION SHALL MEET THE STANDARDS AND SPECIFICATIONS OF THE CITY OF COLORADO SPRINGS/EL PASO COUNTY DRAINAGE CRITERIA MANUAL, VOLUMES 1 AND 2, AND THE EL PASO COUNTY ENGINEERING CRITERIA MANUAL.
- CONTRACTOR SHALL BE RESPONSIBLE FOR THE NOTIFICATION AND FIELD NOTIFICATION OF ALL EXISTING UTILITIES, WHETHER SHOWN ON THE PLANS OR NOT, BEFORE BEGINNING CONSTRUCTION. LOCATION OF EXISTING UTILITIES SHALL BE VERIFIED BY THE CONTRACTOR PRIOR TO CONSTRUCTION. CALL 811 TO CONTACT THE UTILITY NOTIFICATION CENTER OF COLORADO (UNCC).
- CONTRACTOR SHALL KEEP A COPY OF THESE APPROVED PLANS, THE GRADING AND EROSION CONTROL PLAN, THE STORMWATER MANAGEMENT PLAN (SWMP), THE SOIL AND GEOTECHNICAL REPORT, AND THE APPROPRIATE DESIGN AND CONSTRUCTION STANDARDS AND SPECIFICATIONS AT THE JOB SITE AT ALL TIMES, INCLUDING THE FOLLOWING:
 - EL PASO COUNTY ENGINEERING CRITERIA MANUAL (ECM)
 - CITY OF COLORADO SPRINGS/EL PASO COUNTY DRAINAGE CRITERIA MANUAL, VOLUMES 1 AND 2
 - COLORADO DEPARTMENT OF TRANSPORTATION (CDOT) STANDARD SPECIFICATIONS AND BRIDGE CONSTRUCTION
 - CDOT M&S STANDARDS
- NOTWITHSTANDING ANYTHING DEPICTED IN THESE PLANS IN WORDS OR GRAPHIC REPRESENTATION, ALL DESIGN AND CONSTRUCTION RELATED TO ROADS, STORM DRAINAGE AND EROSION CONTROL SHALL CONFORM TO THE STANDARDS AND REQUIREMENTS OF THE MOST RECENT VERSIONS OF THE RELEVANT ADOPTED EL PASO COUNTY STANDARDS, INCLUDING THE LAND DEVELOPMENT CODE, THE ENGINEERING CRITERIA MANUAL, THE DRAINAGE CRITERIA MANUAL, AND THE DRAINAGE CRITERIA MANUAL VOLUME 2. ANY DEVIATIONS FROM REGULATIONS AND STANDARDS MUST BE REQUESTED, AND APPROVED, IN WRITING. ANY MODIFICATIONS NECESSARY TO MEET CRITERIA AFTER-THE-FACT WILL BE ENTIRELY THE DEVELOPER'S RESPONSIBILITY TO RECTIFY.
- IT IS THE DESIGN ENGINEER'S RESPONSIBILITY TO ACCURATELY SHOW EXISTING CONDITIONS, BOTH ON-SITE AND OFF-SITE, ON THE CONSTRUCTION PLANS. ANY MODIFICATIONS NECESSARY DUE TO CONFLICTS, OMISSIONS, OR CHANGED CONDITIONS WILL BE ENTIRELY THE DEVELOPER'S RESPONSIBILITY TO RECTIFY.
- CONTRACTOR SHALL SCHEDULE A PRE-CONSTRUCTION MEETING WITH EL PASO COUNTY PLANNING AND COMMUNITY DEVELOPMENT INSPECTIONS, PRIOR TO STARTING CONSTRUCTION.
- IT IS THE CONTRACTOR'S RESPONSIBILITY TO UNDERSTAND THE REQUIREMENTS OF ALL JURISDICTIONAL AGENCIES TO OBTAIN ALL REQUIRED PERMITS, INCLUDING BUT NOT LIMITED TO EL PASO COUNTY EROSION AND STORMWATER QUALITY CONTROL PERMIT (ESQCP), REGIONAL BUILDING FLOODPLAIN DEVELOPMENT PERMIT, U.S. ARMY CORPS OF ENGINEERS-ISSUED 401 AND/OR 404 PERMITS, AND COUNTY AND STATE FUGITIVE DUST PERMITS.
- CONTRACTOR SHALL NOT DEVIATE FROM THE PLANS WITHOUT FIRST OBTAINING WRITTEN APPROVAL FROM THE DESIGN ENGINEER AND PCD. CONTRACTOR SHALL NOTIFY THE DESIGN ENGINEER IMMEDIATELY UPON DISCOVERY OF ANY ERRORS OR INCONSISTENCIES.
- CONTRACTOR SHALL COORDINATE GEOTECHNICAL TESTING PER ECM STANDARDS. PAVEMENT DESIGN SHALL BE APPROVED BY EL PASO COUNTY PCD PRIOR TO PLACEMENT OF CURB AND GUTTER AND PAVEMENT.
- ALL CONSTRUCTION TRAFFIC MUST ENTER/EXIT THE SITE AT APPROVED CONSTRUCTION ACCESS POINTS.
- SIGHT VISIBILITY TRIANGLES ARE IDENTIFIED IN THE PLANS SHALL BE PROVIDED AT ALL INTERSECTIONS. OBSTRUCTIONS GREATER THAN 18 INCHES ABOVE FLOWLINE ARE NOT ALLOWED IN SIGHT TRIANGLES.
- SIGNING AND STRIPING SHALL COMPLY WITH EL PASO COUNTY DEPARTMENT OF PUBLIC WORKS AND MUTCD CRITERIA.
- CONTRACTOR SHALL OBTAIN ANY PERMITS REQUIRED BY EL PASO COUNTY DEPARTMENT OF PUBLIC WORKS, INCLUDING WORK WITHIN THE RIGHT-OF-WAY AND SPECIAL TRANSPORT PERMITS.
- THE LIMITS OF CONSTRUCTION SHALL REMAIN WITHIN THE PROPERTY LINE UNLESS OTHERWISE NOTED. THE OWNER/DEVELOPER SHALL OBTAIN WRITTEN PERMISSION AND EASEMENTS, WHERE REQUIRED, FROM ADJOINING PROPERTY OWNER(S) PRIOR TO ANY OFF-SITE DISTURBANCE, GRADING, OR CONSTRUCTION.

THE LOCATIONS OF EXISTING ABOVE GROUND AND UNDERGROUND UTILITIES ARE SHOWN IN AN APPROXIMATE WAY ONLY. THE CONTRACTOR SHALL DETERMINE THE EXACT LOCATION OF ALL EXISTING UTILITIES BEFORE COMMENCING WORK. THE CONTRACTOR SHALL BE FULLY RESPONSIBLE FOR ANY AND ALL DAMAGES WHICH MIGHT BE CAUSED BY HIS FAILURE TO EXACTLY LOCATE AND PRESERVE ANY AND ALL ABOVE GROUND AND UNDERGROUND UTILITIES.

SHEET INDEX

- COVER SHEET
- LEGEND
- GRADING AND EROSION CONTROL PLANS
- POND GRADING
- DETAILS

TOTAL SHEETS: 9



EL PASO COUNTY STATEMENT

COUNTY PLAN REVIEW IS PROVIDED ONLY FOR GENERAL CONFORMANCE WITH COUNTY DESIGN CRITERIA. THE COUNTY IS NOT RESPONSIBLE FOR THE ACCURACY AND ADEQUACY OF THE DESIGN, DIMENSIONS, AND/OR ELEVATIONS WHICH SHALL BE CONFIRMED AT THE JOB SITE. THE COUNTY THROUGH THE APPROVAL OF THIS DOCUMENT ASSUMES NO RESPONSIBILITY FOR COMPLETENESS AND/OR ACCURACY OF THIS DOCUMENT.

FILED IN ACCORDANCE WITH THE REQUIREMENTS OF THE EL PASO COUNTY LAND DEVELOPMENT CODE, DRAINAGE CRITERIA MANUAL, VOLUMES 1 AND 2, AND ENGINEERING CRITERIA MANUAL AS AMENDED.

IN ACCORDANCE WITH ECM SECTION 1.12, THESE CONSTRUCTION DOCUMENTS WILL BE VALID FOR CONSTRUCTION FOR A PERIOD OF 2 YEARS FROM THE DATE SIGNED BY THE EL PASO COUNTY ENGINEER. IF CONSTRUCTION HAS NOT STARTED WITHIN THOSE 2 YEARS, THE PLANS WILL NEED TO BE RESUBMITTED FOR APPROVAL, INCLUDING PAYMENT OF REVIEW FEES AT THE PLANNING AND COMMUNITY DEVELOPMENT DIRECTORS DISCRETION.

JOSHUA PALMER, P.E. DATE

COUNTY ENGINEER/ECM ADMINISTRATOR

OWNER/DEVELOPER STATEMENT

I, THE OWNER/DEVELOPER HAVE READ AND WILL COMPLY WITH THE REQUIREMENTS OF THE GRADING AND EROSION CONTROL PLAN.

PARKER SAMELSON DATE

TAMLIN STORAGE, LLC
57 NEWPORT CIRCLE UNIT B
COLORADO SPRINGS, CO 80906

ENGINEER'S STATEMENT

THIS GRADING AND EROSION CONTROL PLAN WAS PREPARED UNDER MY DIRECTION AND SUPERVISION AND IS CORRECT TO THE BEST OF MY KNOWLEDGE AND BELIEF. SAID PLAN HAS BEEN PREPARED ACCORDING TO THE CRITERIA ESTABLISHED BY THE COUNTY FOR GRADING AND EROSION CONTROL PLANS. I ACCEPT RESPONSIBILITY FOR ANY LIABILITY CAUSED BY ANY NEGLIGENT ACTS, ERRORS OR OMISSIONS ON MY PART IN PREPARING THIS PLANS.

BRYAN T. LAW, P.E.
COLORADO P.E. 25043
FOR AND ON BEHALF OF JR ENGINEERING

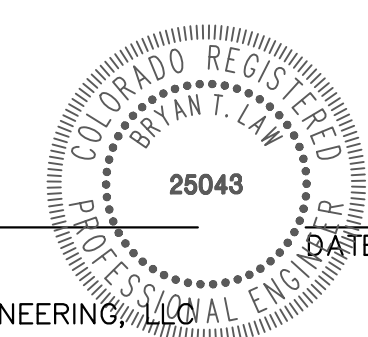

UNTIL SUCH TIME AS THESE DRAWINGS ARE APPROVED BY THE APPROPRIATE REVIEWING AGENCIES, OR ENGINEERING APPROVES THEIR USE, THESE DRAWINGS ARE DESIGNATED BY WRITTEN AUTHORIZATION.

PREPARED FOR
TAMLIN STORAGE LLC
57 NEWPORT CIRCLE UNIT B
COLORADO SPRINGS, CO 80906
PARKER SAMELSON
(719) 659-7126

J.R. ENGINEERING
A Westman Company
Central 303-740-9888 • Colorado Springs 719-583-2583
Fort Collins 970-491-9888 • www.jrengineering.com

DATE	BY	REVISION	No.	1"=1000'	H-SCALE	V-SCALE	N/A	DATE	DESIGNED BY	DRAWN BY	CHECKED BY
								09/25/24	PAL	PAL	

RV STORAGE PROJECT TAMLIN ROAD
COVER SHEET
SHEET 1 OF 9
JOB NO. 25305.00

LEGEND

STABILIZED STAGING AREA	(SSA)		PROPOSED FLOW PATH	
VEHICLE TRACKING CONTROL	(VTC)		EXISTING FLOW PATH	
INLET PROTECTION	(IP)		LIMITS OF CONSTRUCTION/DISTURBANCE	(LOC)
INLET PROTECTION	(IP)		SEEDING AND MULCHING	(PS/ML)
TEMPORARY SEDIMENT BASIN	(TSB)		STOCK PILE	(SP)
CONSTRUCTION FENCE	(CF)		EROSION CONTROL BLANKET	(ECB)
SILT FENCE	(SF)			
CUT/FILL BOUNDARY				

BMP PHASING

INITIAL (SPRING 2025):

1. INSTALL VTC
2. INSTALL OWA
3. ESTABLISH SSA
4. INSTALL CONSTRUCTION FENCE
5. INSTALL SILT FENCE
6. INSTALL SEDIMENT BASIN

INTERIM (SPRING 2025):

1. MAINTAIN ALL BMP'S
2. INSTALL INLET AND OUTLET PROTECTION

FINAL (SUMMER 2025):

1. INSTALL MULCH AND PERMANENT SEEDING IN ALL DISTURBED AREAS
2. REMOVE ALL TEMPORARY BMP'S AFTER FINAL STABILIZATION

FINAL STABILIZATION ANTICIPATED SUMMER 2025

THE LOCATIONS OF EXISTING ABOVE GROUND AND UNDERGROUND UTILITIES ARE SHOWN IN AN APPROXIMATE WAY ONLY. THE CONTRACTOR SHALL DETERMINE THE EXACT LOCATION OF ALL EXISTING UTILITIES BEFORE COMMENCING WORK. THE CONTRACTOR SHALL BE FULLY RESPONSIBLE FOR ANY AND ALL DAMAGES WHICH MIGHT BE CAUSED BY HIS FAILURE TO EXACTLY LOCATE AND PRESERVE ANY AND ALL ABOVE GROUND AND UNDERGROUND UTILITIES.

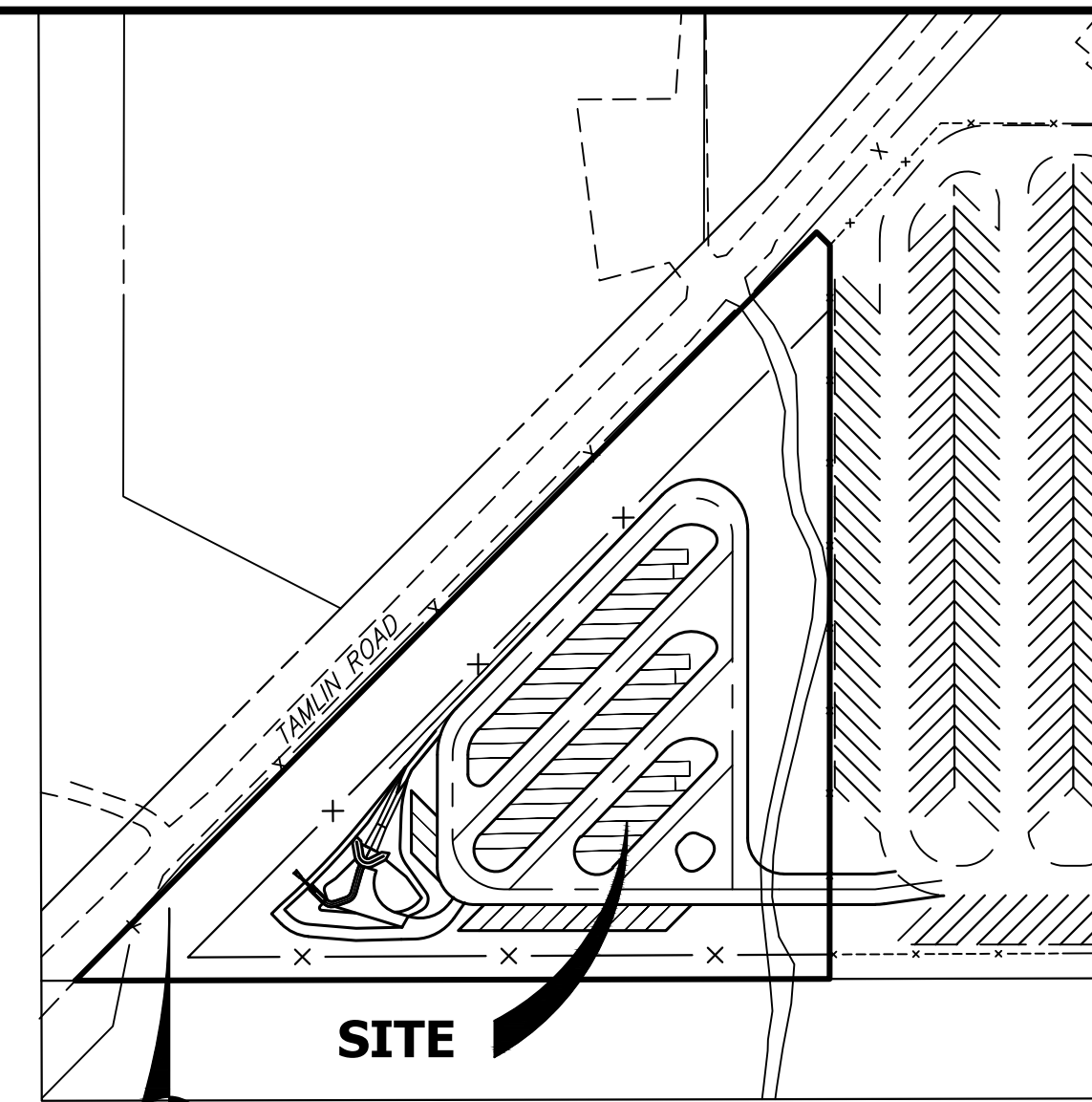
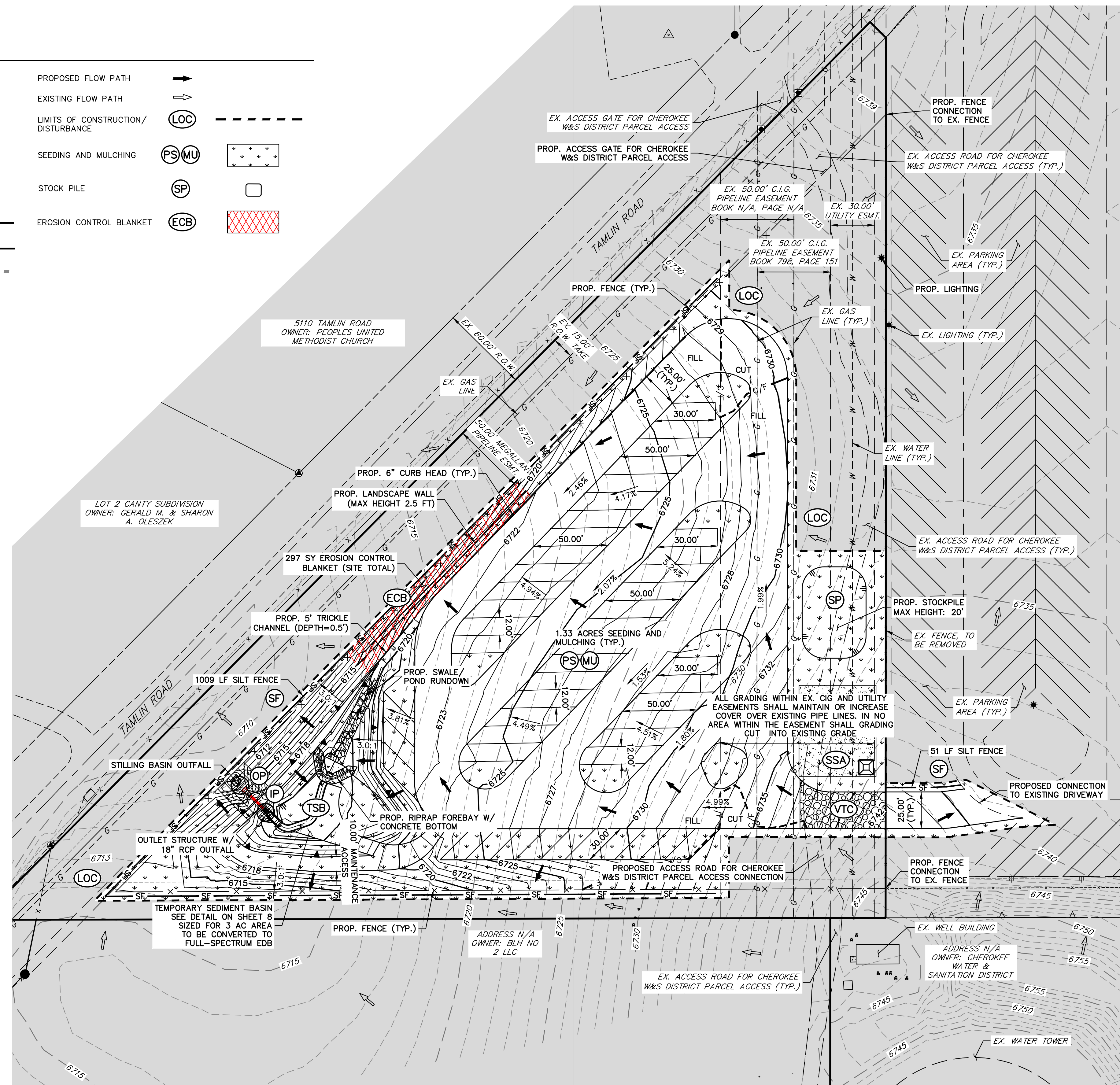

GRADING AND EROSION CONTROL NOTES

1. EXISTING VEGETATION ON THE PROJECT SITE CONSISTS OF SPARSE GRASS.
2. THERE ARE NO DEDICATED ASPHALT OR CONCRETE BATCH PLANTS PROPOSED AS PART OF THIS PROJECT.
3. DEWATERING OPERATIONS ARE NOT ANTICIPATED FOR THIS PROJECT.
4. ALL PROPOSED OFF-SITE STORMWATER CONTROL MEASURES ARE UNDER THE DIRECT CONTROL OR OWNERSHIP OF THE OWNER OR OPERATOR FOR THIS DEVELOPMENT.
5. ALL AREAS TO BE VEGETATED WITH PERMANENT SEEDING SHOULD ALSO BE TEMPORARILY STABILIZED VIA TRACK ROLLING OR SOME OTHER MEANS.
6. CONTRACTOR TO DIRECT RUNOFF FROM DISTURBED AREAS TO PROPOSED TEMPORARY SEDIMENT BASINS WITH TEMPORARY SWALES AND PROPOSED SWALES. IF THE PROPOSED SWALES ARE NOT GRADED, TEMPORARY SWALES MAY BE REQUIRED TO ENSURE DISTURBED AREA RUNOFF IS TREATED IN THE TEMPORARY SEDIMENT BASINS PRIOR TO LEAVING THE SITE.

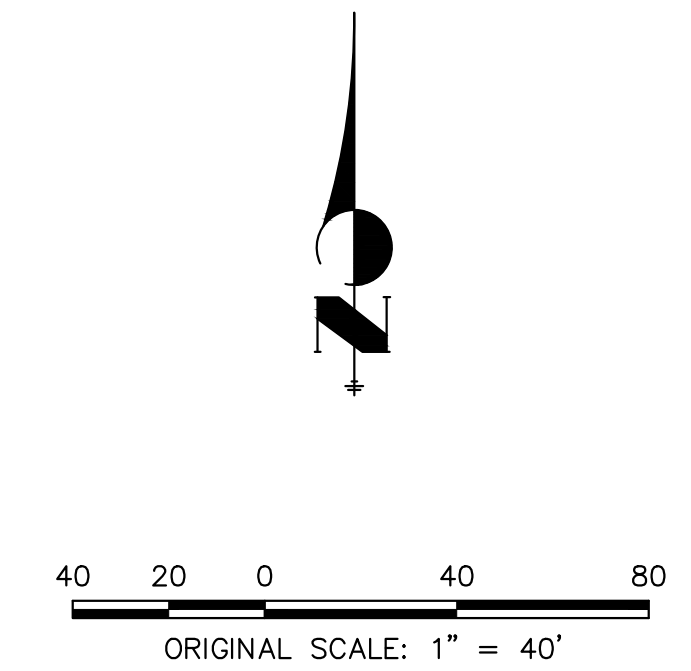

ENGINEER'S STATEMENT

THIS GRADING AND EROSION CONTROL PLAN WAS PREPARED UNDER MY DIRECTION AND SUPERVISION AND IS CORRECT TO THE BEST OF MY KNOWLEDGE AND BELIEF. SAID PLAN HAS BEEN PREPARED ACCORDING TO THE CRITERIA ESTABLISHED BY THE COUNTY FOR GRADING AND EROSION CONTROL PLANS. I ACCEPT RESPONSIBILITY FOR ANY LIABILITY CAUSED BY ANY NEGLIGENT ACTS, ERRORS OR OMISSIONS ON MY PART IN PREPARING THIS PLANS.

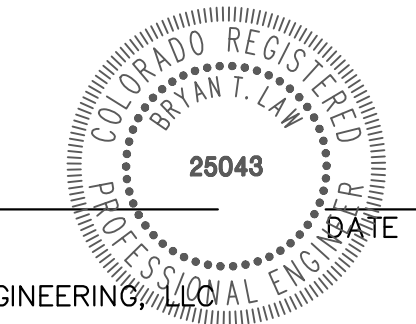

BRYAN T. LAW, P.E.
COLORADO P.E. 25043
FOR AND ON BEHALF OF JR ENGINEERING



Know what's below.
Call before you dig.

UNTIL SUCH TIME AS THESE DRAWINGS ARE APPROVED BY THE APPROPRIATE REVIEWING AGENCIES, OR ENGINEERING APPROVES THEIR USE, THESE DRAWINGS ARE DESIGNATED BY WRITTEN AUTHORIZATION. PREPARED FOR TAMLIN STORAGE LLC 57 NEWPORT CIRCLE UNIT B COLORADO SPRINGS, CO 80906 PARKER SAMUELSON (719) 659-7126	J.R. ENGINEERING A Westman Company Centennial 303-740-9888 • Colorado Springs 719-583-2583 Fort Collins 970-491-9888 • www.jrengineering.com	No.	REVISION	DATE	
		H-SCALE 1"=40'	V-SCALE N/A	DATE 09/25/24	DESIGNED BY PAL
RV STORAGE PROJECT TAMLIN ROAD GRADING AND EROSION CONTROL PLANS		SHEET	3	OF	9
JOB NO. 25305.00					

SC-6 Inlet Protection (IP)

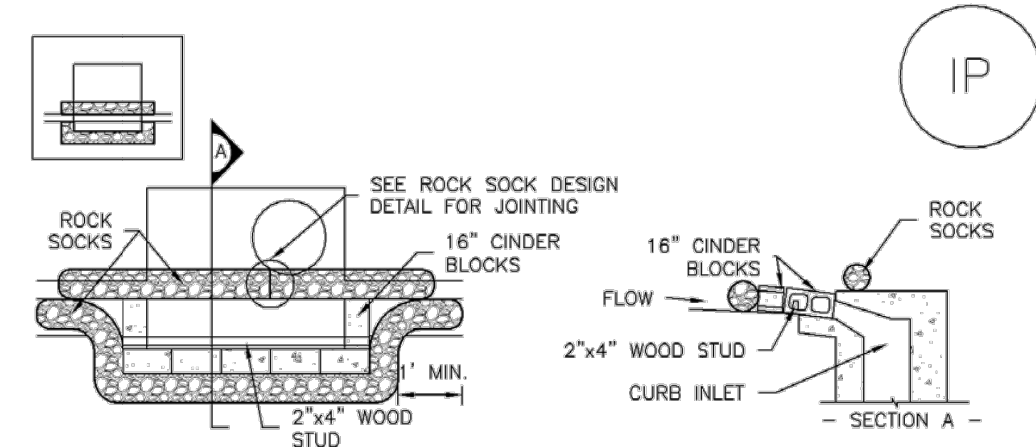

IP-1. BLOCK AND ROCK SOCK SUMP OR ON GRADE INLET PROTECTION

BLOCK AND CURB SOCK INLET PROTECTION INSTALLATION NOTES

- SEE ROCK SOCK DESIGN DETAIL FOR INSTALLATION REQUIREMENTS.
- CONCRETE "CINDER" BLOCKS SHALL BE LAID ON THEIR SIDES AROUND THE INLET IN A SINGLE ROW, ABUTTING ONE ANOTHER WITH THE OPEN END FACING AWAY FROM THE CURB.
- GRAVEL BAGS SHALL BE PLACED AROUND CONCRETE BLOCKS, CLOSELY ABUTTING ONE ANOTHER AND JOINED TOGETHER IN ACCORDANCE WITH ROCK SOCK DESIGN DETAIL.

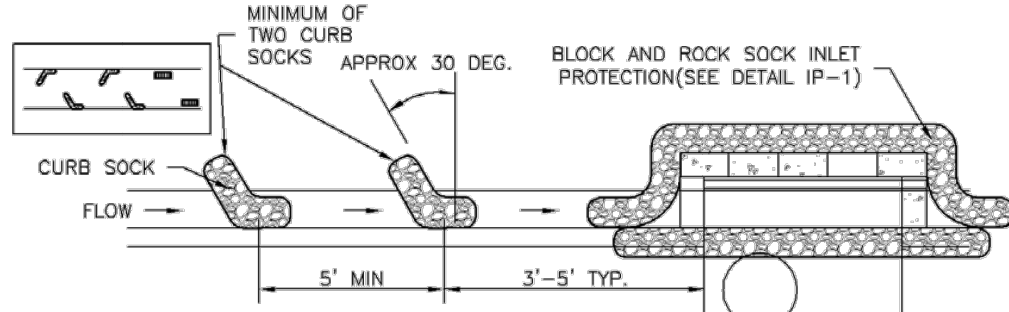

IP-2. CURB ROCK SOCKS UPSTREAM OF INLET PROTECTION

CURB ROCK SOCK INLET PROTECTION INSTALLATION NOTES

- SEE ROCK SOCK DESIGN DETAIL INSTALLATION REQUIREMENTS.
- PLACEMENT OF THE SOCK SHALL BE APPROXIMATELY 30 DEGREES FROM PERPENDICULAR IN THE OPPOSITE DIRECTION OF FLOW.
- SOCKS ARE TO BE FLUSH WITH THE CURB AND SPACED A MINIMUM OF 5 FEET APART.
- AT LEAST TWO CURB SOCKS IN SERIES ARE REQUIRED UPSTREAM OF ON-GRADE INLETS.

IP-4 Urban Drainage and Flood Control District August 2013
Urban Storm Drainage Criteria Manual Volume 3

SC-6 Inlet Protection (IP)

GENERAL INLET PROTECTION INSTALLATION NOTES

- SEE PLAN VIEW FOR:
-LOCATION OF INLET PROTECTION.
-TYPE OF INLET PROTECTION (IP-1, IP-2, IP-3, IP-4, IP-5, IP-6)
- INLET PROTECTION SHALL BE INSTALLED PROMPTLY AFTER INLET CONSTRUCTION OR PAVING IS COMPLETE (TYPICALLY WITHIN 48 HOURS). IF A RAINFALL/RUNOFF EVENT IS FORECAST, INSTALL INLET PROTECTION PRIOR TO ONSET OF EVENT.
- MANY JURISDICTIONS HAVE BMP DETAILS THAT VARY FROM UDFCD STANDARD DETAILS. CONSULT WITH LOCAL JURISDICTIONS AS TO WHICH DETAIL SHOULD BE USED WHEN DIFFERENCES ARE NOTED.

INLET PROTECTION MAINTENANCE NOTES

- INSPECT BMPs EACH WORKDAY, AND MAINTAIN THEM IN EFFECTIVE OPERATING CONDITION. MAINTENANCE OF BMPs SHOULD BE PROACTIVE, NOT REACTIVE. INSPECT BMPs AS SOON AS POSSIBLE (AND ALWAYS WITHIN 24 HOURS) FOLLOWING A STORM THAT CAUSES SURFACE EROSION, AND PERFORM NECESSARY MAINTENANCE.
- FREQUENT OBSERVATIONS AND MAINTENANCE ARE NECESSARY TO MAINTAIN BMPs IN EFFECTIVE OPERATING CONDITION. INSPECTIONS AND CORRECTIVE MEASURES SHOULD BE DOCUMENTED THOROUGHLY.
- WHERE BMPs HAVE FAILED, REPAIR OR REPLACEMENT SHOULD BE INITIATED UPON DISCOVERY OF THE FAILURE.
- SEDIMENT ACCUMULATED UPSTREAM OF INLET PROTECTION SHALL BE REMOVED AS NECESSARY TO MAINTAIN BMP EFFECTIVENESS. TYPICALLY WHEN STORAGE VOLUME REACHES 50% OF CAPACITY, A DEPTH OF 6" WHEN SILT FENCE IS USED, OR 1/4 OF THE HEIGHT FOR STRAW BALES.
- INLET PROTECTION IS TO REMAIN IN PLACE UNTIL THE UPSTREAM DISTURBED AREA IS PERMANENTLY STABILIZED, UNLESS THE LOCAL JURISDICTION APPROVES EARLIER REMOVAL OF INLET PROTECTION IN STREETS.
- WHEN INLET PROTECTION AT AREA INLETS IS REMOVED, THE DISTURBED AREA SHALL BE COVERED WITH TOP SOIL, SEEDED AND MULCHED, OR OTHERWISE STABILIZED IN A MANNER APPROVED BY THE LOCAL JURISDICTION.

(DETAIL ADAPTED FROM TOWN OF PARKER, COLORADO AND CITY OF AURORA, COLORADO, NOT AVAILABLE IN AUTOCAD)
NOTE: MANY JURISDICTIONS HAVE BMP DETAILS THAT VARY FROM UDFCD STANDARD DETAILS. CONSULT WITH LOCAL JURISDICTIONS AS TO WHICH DETAIL SHOULD BE USED WHEN DIFFERENCES ARE NOTED.

NOTE: THE DETAILS INCLUDED WITH THIS FACT SHEET SHOW COMMONLY USED, CONVENTIONAL METHODS OF INLET PROTECTION IN THE DENSE METROPOLITAN AREA. THERE ARE MANY PROPRIETARY INLET PROTECTION METHODS ON THE MARKET. UDFCD NEITHER ENDORSES NOR DISCOURAGES USE OF PROPRIETARY INLET PROTECTION; HOWEVER, IN THE EVENT PROPRIETARY METHODS ARE USED, THE APPROPRIATE DETAIL FROM THE MANUFACTURER MUST BE INCLUDED IN THE SWMP AND THE BMP MUST BE INSTALLED AND MAINTAINED AS SHOWN IN THE MANUFACTURER'S DETAILS.

NOTE: SOME MUNICIPALITIES DISCOURAGE OR PROHIBIT THE USE OF STRAW BALES FOR INLET PROTECTION. CHECK WITH LOCAL JURISDICTION TO DETERMINE IF STRAW BALE INLET PROTECTION IS ACCEPTABLE.

IP-8 Urban Drainage and Flood Control District August 2013
Urban Storm Drainage Criteria Manual Volume 3

Inlet Protection (IP) SC-6

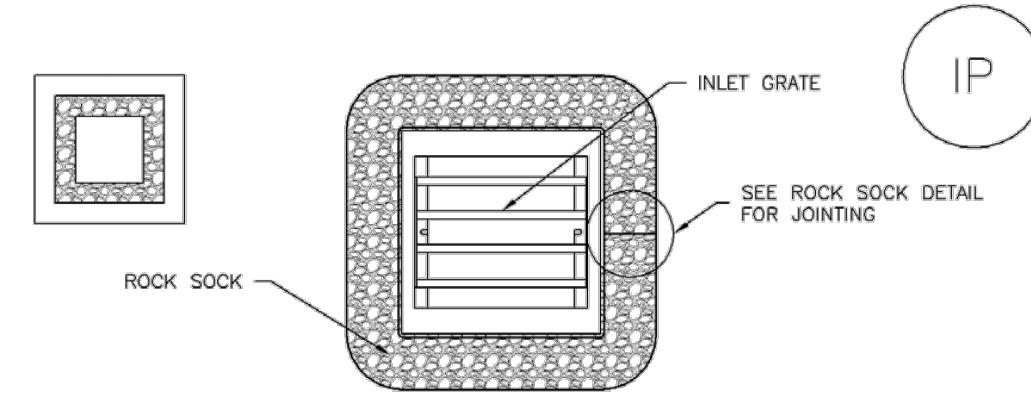

IP-3. ROCK SOCK SUMP/AREA INLET PROTECTION

ROCK SOCK SUMP/AREA INLET PROTECTION INSTALLATION NOTES

- SEE ROCK SOCK DESIGN DETAIL FOR INSTALLATION REQUIREMENTS.
- STRAW WATTLES/SEDIMENT CONTROL LOGS MAY BE USED IN PLACE OF ROCK SOCKS FOR INLETS IN PERVIOUS AREAS. INSTALL PER SEDIMENT CONTROL LOG DETAIL.

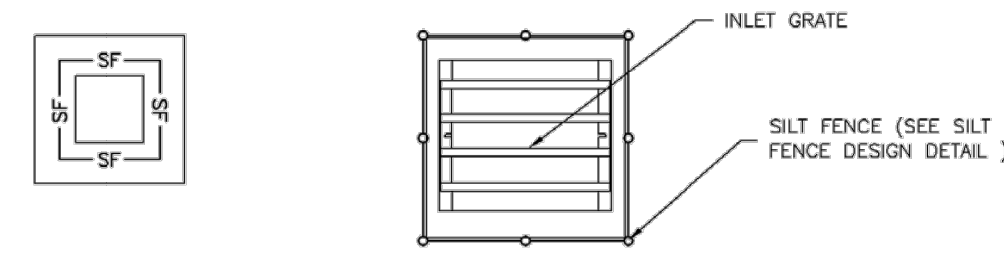

IP-4. SILT FENCE FOR SUMP INLET PROTECTION

SILT FENCE INLET PROTECTION INSTALLATION NOTES

- SEE SILT FENCE DESIGN DETAIL FOR INSTALLATION REQUIREMENTS.
- POSTS SHALL BE PLACED AT EACH CORNER OF THE INLET AND AROUND THE EDGES AT A MAXIMUM SPACING OF 3 FEET.
- STRAW WATTLES/SEDIMENT CONTROL LOGS MAY BE USED IN PLACE OF SILT FENCE FOR INLETS IN PERVIOUS AREAS. INSTALL PER SEDIMENT CONTROL LOG DETAIL.

August 2013 Urban Drainage and Flood Control District August 2013 IP-5
Urban Storm Drainage Criteria Manual Volume 3

EC-8 Temporary Outlet Protection (TOP)

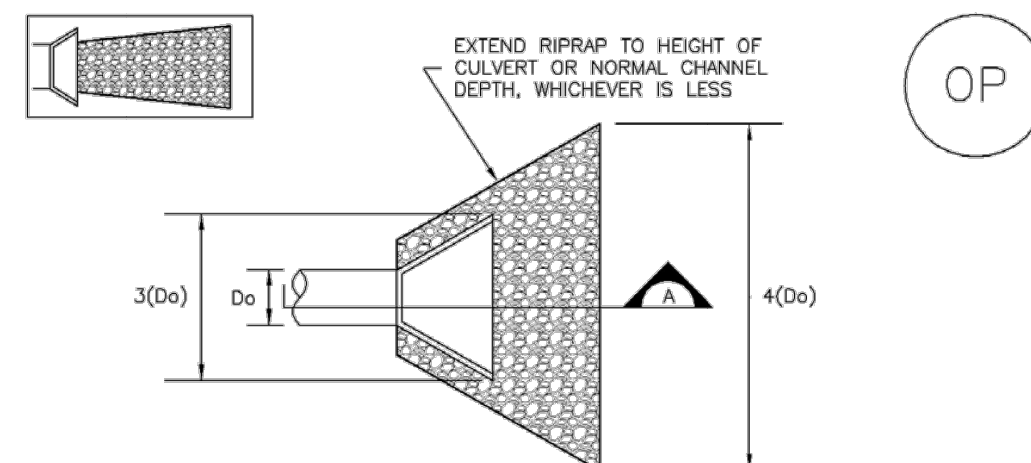

TEMPORARY OUTLET PROTECTION PLAN

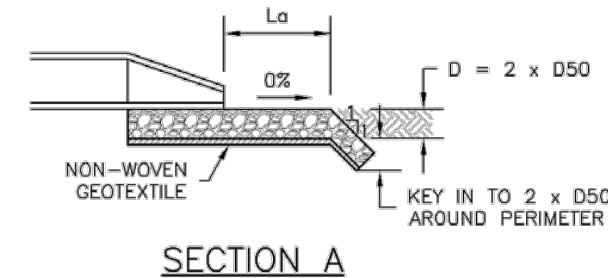
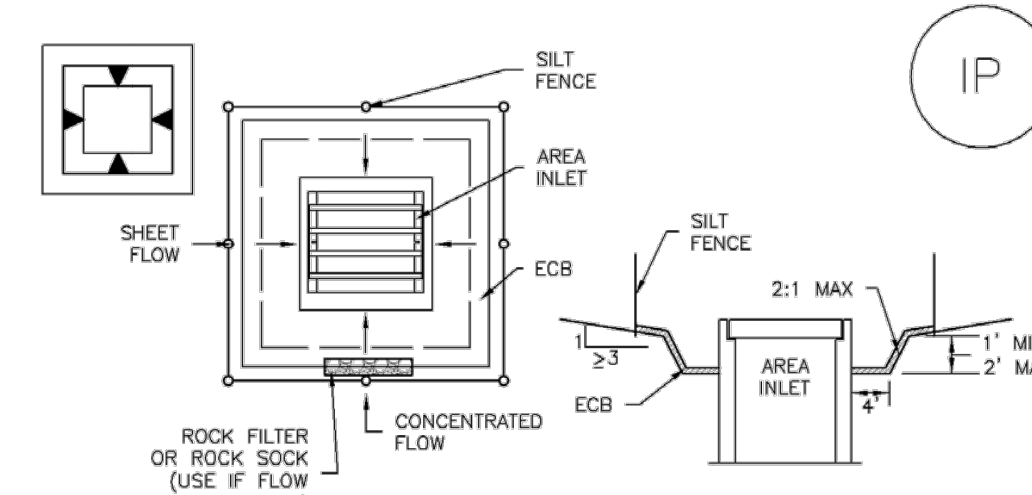

TABLE OP-1. TEMPORARY OUTLET PROTECTION SIZING TABLE			
PIPE DIAMETER, D _o (INCHES)	DISCHARGE, Q (CFS)	APRON LENGTH, L _a (FT)	RIPRAP D ₅₀ DIAMETER MIN (INCHES)
8	2.5	5	4
	5	10	6
12	10	10	4
	30	13	6
18	10	10	6
	20	16	9
24	30	23	12
	40	26	16
24	30	16	9
	40	26	9
24	50	26	12
	60	30	16

OP-1. TEMPORARY OUTLET PROTECTION

TOP-2 Urban Drainage and Flood Control District November 2010
Urban Storm Drainage Criteria Manual Volume 3

SC-6 Inlet Protection (IP)



IP-5. OVEREXCAVATION INLET PROTECTION

OVEREXCAVATION INLET PROTECTION INSTALLATION NOTES

- THIS FORM OF INLET PROTECTION IS PRIMARILY APPLICABLE FOR SITES THAT HAVE NOT YET REACHED FINAL GRADE AND SHOULD BE USED ONLY FOR INLETS WITH A RELATIVELY SMALL CONTRIBUTING DRAINAGE AREA.
- WHEN USING FOR CONCENTRATED FLOWS, SHAPE BASIN IN 2:1 RATIO WITH LENGTH ORIENTED TOWARDS DIRECTION OF FLOW.
- SEDIMENT MUST BE PERIODICALLY REMOVED FROM THE OVEREXCAVATED AREA.

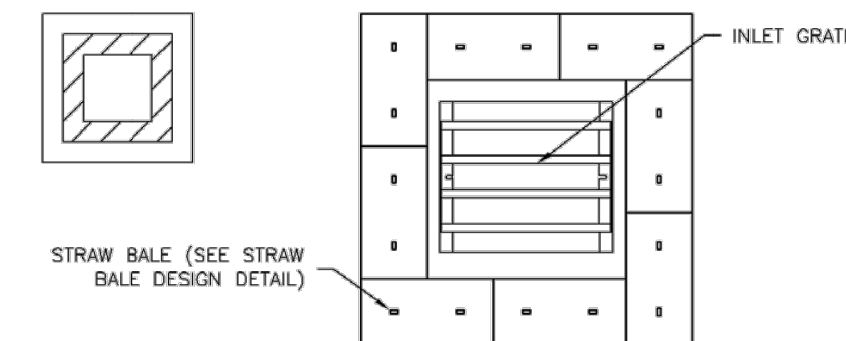

IP-6. STRAW BALE FOR SUMP INLET PROTECTION

STRAW BALE BARRIER INLET PROTECTION INSTALLATION NOTES

- SEE STRAW BALE DESIGN DETAIL FOR INSTALLATION REQUIREMENTS.
- BALES SHALL BE PLACED IN A SINGLE ROW AROUND THE INLET WITH ENDS OF BALES TIGHTLY ABUTTING ONE ANOTHER.

IP-6 Urban Drainage and Flood Control District August 2013
Urban Storm Drainage Criteria Manual Volume 3

Temporary Outlet Protection (TOP) EC-8

TEMPORARY OUTLET PROTECTION INSTALLATION NOTES

- SEE PLAN VIEW FOR:
-LOCATION OF OUTLET PROTECTION.
-DIMENSIONS OF OUTLET PROTECTION.
- DETAIL IS INTENDED FOR PIPES WITH SLOPE ≤ 10%. ADDITIONAL EVALUATION OF RIPRAP SIZING AND OUTLET PROTECTION DIMENSIONS REQUIRED FOR STEEPER SLOPES.
- TEMPORARY OUTLET PROTECTION INFORMATION IS FOR OUTLETS INTENDED TO BE UTILIZED LESS THAN 2 YEARS.

TEMPORARY OUTLET PROTECTION INSPECTION AND MAINTENANCE NOTES

- INSPECT BMPs EACH WORKDAY, AND MAINTAIN THEM IN EFFECTIVE OPERATING CONDITION. MAINTENANCE OF BMPs SHOULD BE PROACTIVE, NOT REACTIVE. INSPECT BMPs AS SOON AS POSSIBLE (AND ALWAYS WITHIN 24 HOURS) FOLLOWING A STORM THAT CAUSES SURFACE EROSION, AND PERFORM NECESSARY MAINTENANCE.
- FREQUENT OBSERVATIONS AND MAINTENANCE ARE NECESSARY TO MAINTAIN BMPs IN EFFECTIVE OPERATING CONDITION. INSPECTIONS AND CORRECTIVE MEASURES SHOULD BE DOCUMENTED THOROUGHLY.
- WHERE BMPs HAVE FAILED, REPAIR OR REPLACEMENT SHOULD BE INITIATED UPON DISCOVERY OF THE FAILURE.

NOTE: MANY JURISDICTIONS HAVE BMP DETAILS THAT VARY FROM UDFCD STANDARD DETAILS. CONSULT WITH LOCAL JURISDICTIONS AS TO WHICH DETAIL SHOULD BE USED WHEN DIFFERENCES ARE NOTED.

(DETAILS ADAPTED FROM AURORA, COLORADO AND PREVIOUS VERSION OF VOLUME 3, NOT AVAILABLE IN AUTOCAD)

November 2010 Urban Drainage and Flood Control District November 2010 TOP-3
Urban Storm Drainage Criteria Manual Volume 3

Inlet Protection (IP) SC-6

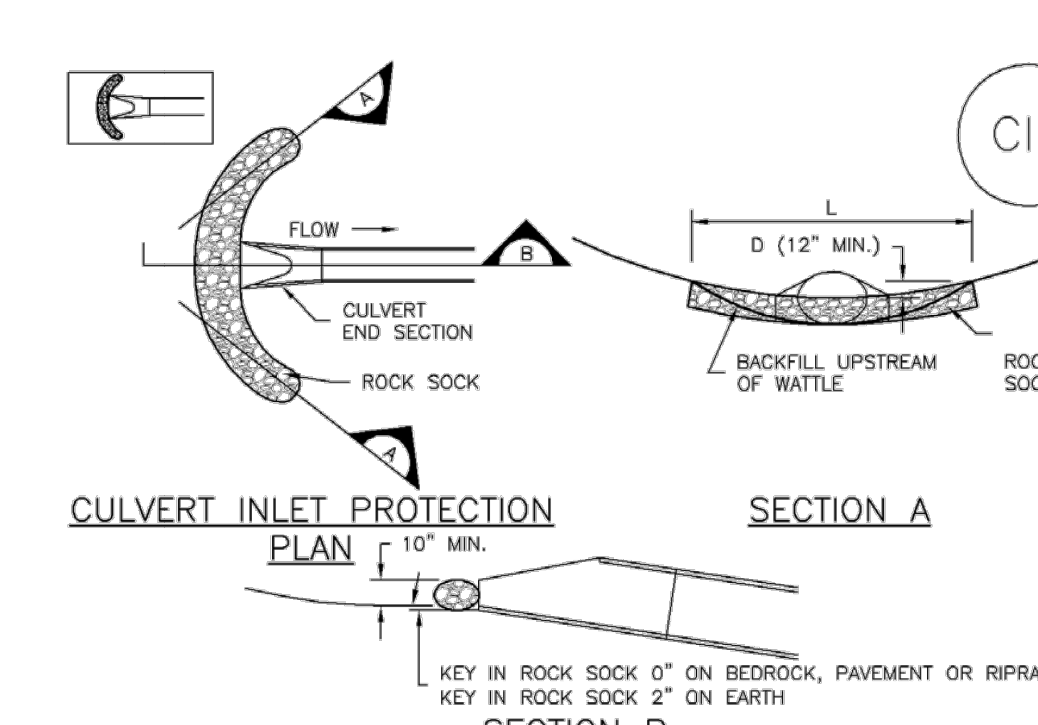

CIP-1. CULVERT INLET PROTECTION

CULVERT INLET PROTECTION INSTALLATION NOTES

- SEE PLAN VIEW FOR:
-LOCATION OF CULVERT INLET PROTECTION.
- SEE ROCK SOCK DESIGN DETAIL FOR ROCK GRADATION REQUIREMENTS AND JOINING DETAIL.

CULVERT INLET PROTECTION MAINTENANCE NOTES

- INSPECT BMPs EACH WORKDAY, AND MAINTAIN THEM IN EFFECTIVE OPERATING CONDITION. MAINTENANCE OF BMPs SHOULD BE PROACTIVE, NOT REACTIVE. INSPECT BMPs AS SOON AS POSSIBLE (AND ALWAYS WITHIN 24 HOURS) FOLLOWING A STORM THAT CAUSES SURFACE EROSION, AND PERFORM NECESSARY MAINTENANCE.
- FREQUENT OBSERVATIONS AND MAINTENANCE ARE NECESSARY TO MAINTAIN BMPs IN EFFECTIVE OPERATING CONDITION. INSPECTIONS AND CORRECTIVE MEASURES SHOULD BE DOCUMENTED THOROUGHLY.
- WHERE BMPs HAVE FAILED, REPAIR OR REPLACEMENT SHOULD BE INITIATED UPON DISCOVERY OF THE FAILURE.
- SEDIMENT ACCUMULATED UPSTREAM OF THE CULVERT SHALL BE REMOVED WHEN THE SEDIMENT DEPTH IS 1/2 THE HEIGHT OF THE ROCK SOCK.
- CULVERT INLET PROTECTION SHALL REMAIN IN PLACE UNTIL THE UPSTREAM DISTURBED AREA IS PERMANENTLY STABILIZED AND APPROVED BY THE LOCAL JURISDICTION.

(DETAILS ADAPTED FROM AURORA, COLORADO, NOT AVAILABLE IN AUTOCAD)
NOTE: MANY JURISDICTIONS HAVE BMP DETAILS THAT VARY FROM UDFCD STANDARD DETAILS. CONSULT WITH LOCAL JURISDICTIONS AS TO WHICH DETAIL SHOULD BE USED WHEN DIFFERENCES ARE NOTED.

August 2013 Urban Drainage and Flood Control District August 2013 IP-7
Urban Storm Drainage Criteria Manual Volume 3

UNTIL SUCH TIME AS THESE DRAWINGS ARE APPROVED BY THE APPROPRIATE REVIEWING AGENCIES, JR ENGINEERING APPROVES THEIR USE. THESE DRAWINGS ARE DESIGNATED BY WRITTEN AUTHORIZATION.

PREPARED FOR
TAMLIN STORAGE LLC
57 NEWPORT CIRCLE UNIT B
COLORADO SPRINGS, CO 80906
PARKER SAMELSON
(719) 659-7126

JR ENGINEERING
A Westman Company
Central 303-740-8888 • Colorado Springs 719-583-2583
Fort Collins 970-491-9888 • www.jrengineering.com

BY	DATE	REVISION	No.	H-SCALE	V-SCALE	DATE	DESIGNED BY	DRAWN BY	CHECKED BY	N/A	N/A	09/25/24	PAL	PAL	PAL	PAL	PAL	PAL	PAL
RV STORAGE PROJECT TAMLIN ROAD DETAILS																			



ENGINEER'S STATEMENT
STANDARD DETAILS SHOWN WERE REVIEWED ONLY AS TO THEIR APPLICATION ON THIS PROJECT

BRYAN T. LAW, P.E.
COLORADO P.E. 25043
FOR AND ON BEHALF OF JR ENGINEERING

25043
DATE

APPENDIX D – INSPECTION REPORT TEMPLATE

CONSTRUCTION STORMWATER SITE INSPECTION REPORT

Facility Name		Permittee					
Date of Inspection		Weather Conditions					
Permit Certification #		Disturbed Acreage					
Phase of Construction		Inspector Title					
Inspector Name							
Is the above inspector a qualified stormwater manager? (permittee is responsible for ensuring that the inspector is a qualified stormwater manager)			<table border="1" style="width: 100%; border-collapse: collapse;"> <tr> <td style="width: 50%; text-align: center;">YES</td> <td style="width: 50%; text-align: center;">NO</td> </tr> <tr> <td style="text-align: center;"><input type="checkbox"/></td> <td style="text-align: center;"><input type="checkbox"/></td> </tr> </table>	YES	NO	<input type="checkbox"/>	<input type="checkbox"/>
YES	NO						
<input type="checkbox"/>	<input type="checkbox"/>						

INSPECTION FREQUENCY					
Check the box that describes the minimum inspection frequency utilized when conducting each inspection					
At least one inspection every 7 calendar days	<input type="checkbox"/>				
At least one inspection every 14 calendar days, with post-storm event inspections conducted within 24 hours after the end of any precipitation or snowmelt event that causes surface erosions	<input type="checkbox"/>				
<ul style="list-style-type: none"> • This is this a post-storm event inspection. Event Date: _____ 	<input type="checkbox"/>				
Reduced inspection frequency - Include site conditions that warrant reduced inspection frequency	<input type="checkbox"/>				
<ul style="list-style-type: none"> • Post-storm inspections at temporarily idle sites 	<input type="checkbox"/>				
<ul style="list-style-type: none"> • Inspections at completed sites/area 	<input type="checkbox"/>				
<ul style="list-style-type: none"> • Winter conditions exclusion 	<input type="checkbox"/>				
Have there been any deviations from the minimum inspection schedule? If yes, describe below.	<table border="1" style="width: 100%; border-collapse: collapse;"> <tr> <td style="width: 50%; text-align: center;">YES</td> <td style="width: 50%; text-align: center;">NO</td> </tr> <tr> <td style="text-align: center;"><input type="checkbox"/></td> <td style="text-align: center;"><input type="checkbox"/></td> </tr> </table>	YES	NO	<input type="checkbox"/>	<input type="checkbox"/>
YES	NO				
<input type="checkbox"/>	<input type="checkbox"/>				

INSPECTION REQUIREMENTS*
i. Visually verify all implemented control measures are in effective operational condition and are working as designed in the specifications
ii. Determine if there are new potential sources of pollutants
iii. Assess the adequacy of control measures at the site to identify areas requiring new or modified control measures to minimize pollutant discharges
iv. Identify all areas of non-compliance with the permit requirements, and if necessary, implement corrective action
*Use the attached Control Measures Requiring Routine Maintenance and Inadequate Control Measures Requiring Corrective Action forms to document results of this assessment that trigger either maintenance or corrective actions

AREAS TO BE INSPECTED			
Is there evidence of, or the potential for, pollutants leaving the construction site boundaries, entering the stormwater drainage system or discharging to state waters at the following locations?			
	NO	YES	If "YES" describe discharge or potential for discharge below. Document related maintenance, inadequate control measures and corrective actions Inadequate Control Measures Requiring Corrective Action form
Construction site perimeter	<input type="checkbox"/>	<input type="checkbox"/>	
All disturbed areas	<input type="checkbox"/>	<input type="checkbox"/>	
Designated haul routes	<input type="checkbox"/>	<input type="checkbox"/>	
Material and waste storage areas exposed to precipitation	<input type="checkbox"/>	<input type="checkbox"/>	
Locations where stormwater has the potential to discharge offsite	<input type="checkbox"/>	<input type="checkbox"/>	
Locations where vehicles exit the site	<input type="checkbox"/>	<input type="checkbox"/>	
Other: _____	<input type="checkbox"/>	<input type="checkbox"/>	

REPORTING REQUIREMENTS

The permittee shall report the following circumstances orally within twenty-four (24) hours from the time the permittee becomes aware of the circumstances, and shall mail to the division a written report containing the information requested within five (5) working days after becoming aware of the following circumstances. The division may waive the written report required if the oral report has been received within 24 hours.

All Noncompliance Requiring 24-Hour Notification per Part II.L.6 of the Permit		
a. Endangerment to Health or the Environment Circumstances leading to any noncompliance which may endanger health or the environment regardless of the cause of the incident (See Part II.L.6.a of the Permit) <i>This category would primarily result from the discharge of pollutants in violation of the permit</i>		
b. Numeric Effluent Limit Violations <ul style="list-style-type: none"> o Circumstances leading to any unanticipated bypass which exceeds any effluent limitations (See Part II.L.6.b of the Permit) o Circumstances leading to any upset which causes an exceedance of any effluent limitation (See Part II.L.6.c of the Permit) o Daily maximum violations (See Part II.L.6.d of the Permit) <i>Numeric effluent limits are very uncommon in certifications under the COR400000 general permit. This category of noncompliance only applies if numeric effluent limits are included in a permit certification.</i>		

Has there been an incident of noncompliance requiring 24-hour notification?	NO	YES	
	<input type="checkbox"/>	<input type="checkbox"/>	If "YES" document below

Date and Time of Incident	Location	Description of Noncompliance	Description of Corrective Action	Date and Time of 24 Hour Oral Notification	Date of 5 Day Written Notification *

*Attach copy of 5 day written notification to report. Indicate if written notification was waived, including the name of the division personnel who granted waiver.

After adequate corrective action(s) and maintenance have been taken, or where a report does not identify any incidents requiring corrective action or maintenance, the individual(s) designated as the Qualified Stormwater Manager, shall sign and certify the below statement:

"I verify that, to the best of my knowledge and belief, all corrective action and maintenance items identified during the inspection are complete, and the site is currently in compliance with the permit."

Name of Qualified Stormwater Manager

Title of Qualified Stormwater Manager

Signature of Qualified Stormwater Manager

Date

Notes/Comments