

El Paso County
STORMWATER MANAGEMENT PLAN

Falcon Storage Subdivision

Part of the West -half of Section 1, Township 13 South, Range 65 West, 6th P.M.

County Project No.: PPR2232

MS232

March 24, 2021

Revised

March 17, 2022

Revised

December 12-2022

prepared for
Falcon Storage Partners, LLLP

Qualified Stormwater Manager

Name: Erik S. Watts

Company: Oliver E. Watts Consulting Engineer Inc

Address: 614 Elkton Drive Colorado Springs, CO 80907

Contractor

Name: _____

Company: _____

Address: _____

Oliver E. Watts, Consulting Engineer, Inc.
Colorado Springs, Colorado

OLIVER E. WATTS, PE-LS
OLIVER E. WATTS, CONSULTING ENGINEER, INC.
CIVIL ENGINEERING AND SURVEYING
614 ELKTON DRIVE
COLORADO SPRINGS, COLORADO 80907
(719) 593-0173
fax (719) 265-9660
olliewatts@aol.com
Celebrating over 42 years in business

March 17, 2022

El Paso County D.O.T.
3275 Akers Drive
Colorado Springs, CO 80922

ATTN: Permits Unit

SUBJECT: Stormwater Management Plan
Falcon Storage Subdivision

Transmitted herewith for your review and approval is the SWMP for the Falcon Storage Subdivision. It has been revised per County review comments

Please contact our office if we may provide any further information.

Oliver E. Watts, Consulting Engineer, Inc.

BY: _____
Erik S. Watts, Authorized Representative
Erosion Control Supervisor

The developer / owner has read and will comply with all of the requirements specified in this stormwater management report.

By: _____
Richard Graham
Falcon Storage Partners LLLP
4615 Northpark Drive
suite 101
Colorado Springs, CO 80918

Table of Contents

1. Cover
2. Transmittal Letter
3. Table of Contents
4. Report 4 pages
5. Vicinity Map
6. Computations
7. FEMA Panel No. 08041C0535 G, dated December 7, 2018
8. SCS Soils Map and Interpretation Sheet
9. Backup Information, 4 pages
10. Detention Pond Maintenance Agreement, RN. 205075723
11. Grading and Erosion Control Plans

1. SITE DESCRIPTION:

Falcon Storage Subdivision is located just north of 7630 Bent Grass Drive, on the west side of the street, north of Woodmen Road in the West half of Section 1, Township 13 South, Range 65 West of the 6th P.M., in El Paso County. The overall Site totals 5.004 acres. Grading is also to occur on 4.86 acres of the lot.

Lat: 38° 56' 48.40432 " N

Long: 104° 37' 31.67081 " W

a) **Construction activity description:** Construction activity for the site will include; overlot grading, and construction of a parking / RV storage lot. The site will be landscaped / reseeded once all construction has been completed.

b) **Sequence / time line of activities:** The site will be overlot graded per the enclosed grading plan. All site grading is to be in compliance with El Paso County Code. Grading for the site, is scheduled to be completed by fall 2023. Total site landscaping / reseeding should be completed and acceptable ground cover / vegetation established by late November 2023.

c) **Site area:** The site is 5.004 acres total. It is the north end of the 22.137 acre Latigo Business Center Filing No. 1 subdivision. The portion of the site that is to experience grading is approximately 4.86 acres. The Site is vegetated with grasses, and some scrub brush on the north portion. The south portion of the lot is fenced off and being utilized as an RV storage / parking lot: Approximately 55% of the site has some form of vegetation on it. Said vegetation, is outside of the parking lot and off of Bent Grass. The site is to be graded so as to comply with the Grading and Erosion Control Plans, which accompany the submittal.

d) **Runoff:** Overall runoff from the Site will remain at historic levels because of the proposed detention facility. Attached is the "Description of Runoff" section from the lots drainage letter:

A. Drainage Inflows: *The drainage Report for Falcon Meadows at Bent Grass indicates an existing drainage swale above the north boundary to divert runoff from this site and route it to Bent Grass Meadows and then past this development in Bent Grass Meadows Drive to outfall points to an existing detention pond across the street. A copy of this drainage plan is enclosed. Also shown on this map is that portion of the Meadows Filing No. 1 that drains 0.62 cfs / 3.5 cfs (5-year / 100-year runoffs) into this subdivision along the westerly boundary, and it indicates the historic undeveloped runoff of the site, totaling 1.25 cfs / 7.6 cfs at the lowest (southeast) portion of the subdivision.*

B. Interior Routing: *The area will be graded to conform to the existing topography shown on the drainage plan. The property has been rough graded, which complies with the historic runoff pattern. Minor grading is indicated which is intended to contain the runoff into the interior drive isle street network. The site will be graded to route and contain all runoff within the private north-south streets, terminating at the south boundary. The westerly street (Basin A) will develop 4.1 cfs \ 11.8 cfs (5-year / 100-year runoffs) near the in the southwest corner of the plat. Basins B, C, and D will develop 5.9 cfs / 11.9 cfs in the easterly street near the southeast corner. The total outfall into the detention pond near the southeast corner is 5.5 cfs/12.5 cfs.*

C. Detention Storage: *At the proposed outfall point a detention pond is proposed. The pond is sized for*

sedimentation basins to be used during the construction period and converted into a sand filter basins upon completion. The basin will contain 13320 CF (at 1800 CF per acre). An 8-inch riser pipe is used as an outlet, with holes drilled as computed to detain the runoff as required. One foot of freeboard is provided with a spillway that will pass the 100-year runoff. Details are shown on the enclosed drainage plan. Following construction the basin will be modified to a sand filter basin, with one foot of sand in the bottom. A 4-inch underdrain will drain into the grated inlet outlet structures set at the WQCV level, and sized for the 100-year runoff. An orifice plate will be provided on the end of the underdrain with an orifice sized for the installation. Detention basin stage-storage tables are included for each basin.

C. Outfall Point: *Discharge from the subdivision will be into existing north-south street of Lot 1 of the Latigo Business Center. Some minor construction is shown along the north boundary of Lot 1. The two properties are under common ownership. The drainage plan for this property is enclosed. This report indicated two existing discharges: 0.2 cfs / 0.5 cfs near the southwest corner and 6.1 cfs / 10.1 cfs over the remaining south frontage.*

This parcel is not within the limits of a designated flood plain or flood hazard area, as identified on FEMA Panel No. 08041C0535 G, dated December 7, 2018, a copy of which is enclosed for reference.

The method used for all computations is that specified in the City-County Drainage Criteria Manual, using the rational method for areas of the size of the site and the SCS method for the review of the major basin involved. All computations are enclosed for reference and review.

The local USDA/SCS office has mapped the soils in the area. A soils map interpretation sheet is enclosed for reference. All soils in this area are of hydrologic group "A", Columbine. It has slow surface water runoff, but slight to moderate erodability and rapid permeability. It is listed as having high potential for successful reseeding, especially with 'native' grasses. Potential erosion impacts would affect Bent Grass. Runoff would be carried down the slopes and into the street. Erosion control measures; silt fencing, and reseeding will serve to mitigate this hazard. See page 2, Erosion Control Plan for details.

e) Existing vegetation: As stated previously; Item 1, C "Site Area," vegetation consists of grasses, and some scrub brush. Approximately 55% of the site has some form of vegetation on it. This was determined, per visual inspection at the time of the site topographic survey dated 10-6-20. Per the enclosed Grading and Erosion Control Plans: The area is to be graded as shown and erosion control measures, as shown, and listed in said Plans implemented.

f) Potential pollution sources:

Potential pollution sources which shall be evaluated for potential to contribute to stormwater discharge for the subject site may include the following: disturbed and stored soils, vehicle tracking of sediments, management of contaminated soils, loading and unloading operations, outdoor storage of materials (building material, chemicals, etc.), vehicle and equipment maintenance and fueling, significant dust or particulate generating processes, routine maintenance activities involving fertilizers, pesticides, detergents, fuels, solvents, oils. etc., on-site waste management practices (waste piles, liquid wastes, dumpsters), concrete truck / equipment washing, including the truck

chute and associated fixtures, non-industrial waste sources (worker trash and portable toilet) and other areas or procedures where potential spills can occur. The locations of these areas that affect the site are shown on the enclosed plans.

TABLE 1: POTENTIAL POLLUTION SOURCES

Potential Pollution Sources	Possible Site Contributions of Pollutants to Stormwater Discharges
All disturbed and stored soils	Stockpiles of fill from the excavations, topsoil stockpiles. Imported borrow stockpile.
Vehicle tracking of sediments	See the enclosed drawings for vehicle entrance and exit.
Management of contaminated soils	No contaminated soils are expected to be encountered.
Loading and unloading operations	Loading and unloading of building materials, etc.
Outdoor storage activities (building material, fertilizers, chemicals, etc.)	Building materials and equipment storage areas (no fertilizers, petroleum or chemical products will be stored on-site).
Vehicle and equipment maintenance and fueling	Fueling will occur on-site using mobile equipment (will not be stored on-site). Equipment maintenance will occur off-site.
Significant dust or particulate-generating processes	Vehicle tracking, soil removed from excavation, stockpiles.
Routine maintenance activities involving fertilizers, pesticides, detergents, fuels, solvents, oils, etc.	All equipment maintenance will occur off-site. No fertilizers, pesticides, detergents, and/or solvents will be used or stored on-site.
On-site waste management practices (waste piles, liquid wastes, dumpsters, etc.)	All waste will be removed from site as soon as possible.
Concrete truck/equipment washing, including the concrete truck chute and associated fixtures and equipment	Washout as shown or relocated by contractor.
Dedicated asphalt and concrete batch plants	No dedicated asphalt and concrete batch plants are on-site.
Non-industrial waste sources such as worker trash and portable toilets	Worker trash will be removed from the site as soon as possible. Portable toilets will be provided.
Other areas or procedures where potential spills can occur	Petroleum releases from equipment are possible.

BMP's for Pollutant Prevention:

The following are common practices to mitigate potential pollutants:

- Wind erosion shall be controlled by sprinkling site roadways and/or temporary stabilizing stockpiles. Each dump truck hauling materials to or from the site shall be required to cover its bed with a tarpaulin.
- Sanitary facilities shall be placed a minimum of 10' from any curb and 50' from any inlet. If not feasible for the site, a secondary containment shall be implemented. Toilets shall be secured at all (4) corners to prevent overturning and shall be cleaned weekly. Toilets shall be inspected daily for spills.
- Equipment fueling and maintenances services – a designated fueling area will be

established to contain any spill resulting from fueling, maintenance or repair of equipment. Contractors shall be responsible for containment, cleanup and disposal of any leak or spill and any associated costs of said cleanup / disposal.

- Chemical products shall be protected from precipitation, free from ground contact, and stored properly to prevent damage from equipment, vehicles or workers.
- Material stockpiles (soils, soil amendments, debris/trash piles) – All construction trash and debris will be deposited in the site dumpster(s). Said dumpster shall be inspected daily for spills, overflows and capacity. Dumpsters to be emptied when the “Max Level” line is reached.
- Sediment and mitigation of sediment – Sweeping operations will take place as necessary to maintain roadways / parking areas. The perimeter of the site will be evaluated for any potential impact resulting from trucking operations or sediment mitigation from the site. BMP devices will be placed to protect storm system inlets should any roadway / parking area tracking or sediment mitigation occur.
- Snow removal and/or stockpiling will be considered prior to placement at the site. Snow stockpiles should be kept away from any stormwater conveyance system(s) to include; inlets, ponds, outfall locations, roadway surfaces, etc.

g) Non stormwater discharge: No springs are known to exist. Any additional discharge is confined to the surface and runoff routed to the subdivision detention pond.

h) Receiving water(s), size, type and description of outfall(s): Sand Creek and ultimately Fountain Creek is the receiving water for stormwater discharge from this Site. Outfalls are shown on the enclosed grading plan. NOTE: There are no streams cross this project.

2. SITE MAP:

Enclosed are a vicinity map and grading and erosion control plans for review. Details for the BMP's are shown of the plans.

3. BMPs FOR STORMWATER POLLUTION PREVENTION:

a) Erosion and sediment controls:

1) Structural practices: As indicated on the enclosed Grading and Erosion Control Plans, erosion will be contained through the use of said silt fencing or in the case of the project exit an VTC (vehicle tracing control pad). See Plans for locations and details on silt fencing and VTC. The portion of the lot that has experienced grading will be landscaped or reseeded per County Code (see DCM Volume II for details). discuss TSB. unresolved.

2) Non-Structural practices: Permanent stabilization practices will be implemented on this Site through landscaping and reseeded. Said landscaping/seeding activities will occur when all grading / construction for the site is finished. See the enclosed Grading and Erosion Control Plans for details.

b) Materials handling and Spills Prevention: There are no plans to have any On-Site batch plant(s). Equipment fueling and maintenances services – a designated fueling area will be established to contain any spill resulting from fueling, maintenance or repair of equipment. Contractors shall be responsible for containment, cleanup and disposal of any leak or spill and

any associated costs of said cleanup / disposal. Vehicle refueling will take place away from areas containing or conveying water, or near the existing road, in accordance with State approved practices. Should a fuel or fluid spill occur, the contractor will follow County and State guidelines concerning spills such as; berming the area around the spill and remove all contaminated soil in an approved container and disposing of said containing at a County / State approved facility / Site. Spills will be reported to CDPHE:

Water Quality Control Division
WQCD-Permits
4300 Cherry Creek Drive South
Denver, CO 80246-1530
(303) 692-3517
<http://www.cdphe.state.co.us>

temporary sediment basin

4. FINAL STABILIZATION AND LONG TERM STORMWATER MANAGEMENT:

As stated earlier, copies of the Grading and Erosion Control Plans are submitted for your review. These Plans should adequately address this section. Said plans show a (proposed) detention basin located at the southeast corner of the lot. This will be used as a ~~water quality pond~~ during construction. A perforated PVC pipe will be installed to control the release of storm water. Once site construction is completed, the pond will be converted to a sand filter basin and an outlet installed, per the plans. Our office will have inspectors monitoring the Site during construction to insure compliance with applicable State and El Paso County Code(s). The Permittee will contact your office upon final stabilization, once the vegetation / ground cover reaches 70% of pre-disturbance levels. See re-seed section, on page 9, for suggested final stabilization seed mix, for areas outside the landscaping. The temporary BMP's will be removed upon receiving permission from El Paso County.

5. OTHER CONTROLS:

Please review the enclosed Grading and Erosion Control Plan. It details said controls. Waste disposal will be in accordance with El Paso County standards. A rock mat (VTC) will be installed where shown on the grading plan to remove any soil from vehicles before entering Bent Grass Meadows Drive.

6. INSPECTION AND MAINTENANCE:

The Qualified Stormwater Manager will monitor the day to day Site activities during construction. A copy of this report will be kept in the vehicle of said inspector.

Inspections will occur and reports will be filled out and signed by the Qualified Stormwater Manager every 14 days, and/or after a precipitation or snow melt event, that causes erosion, as required, to ensure adequate operation and design of selected BMP's. Signed copies of said inspection reports will be kept by the permit holder and at this office. Silt fencing will need to be replaced and/or repaired as need be. All litter and debris should be removed from the lot and disposed off of the site (i.e. in a trash bag, trash can, dumpster). The VTC will be inspected weekly and have maintenance and cleaning performed as necessary.

discuss TSB inspection and maintenance.
Unresolved.

7. SWMP REVISION PROCEDURES:

This SWMP should be revised as necessary to address the various phases of grading, construction, and changing site conditions and BMP needs.

The need for revision could include the following: Additional BMPs to control stormwater, as

needed, removal of one of more BMP as items are completed, the weather and precipitation could affect and cause a needed revision in the SWMP. The Qualified Stormwater Manager will revise accordingly.

8. FINAL STABILIZATION:

Re-seed mixture

All disturbed areas shall be re-graded and, those areas not covered by landscaping could be reseeded with the following native grass mixture for sandy soils:

GRASS	VARIETY	AMOUNT IN PLS LBS PER ACRE
Sideoats Grama	El Reno	3.0 Lbs
Western Wheatgrass	Barton	2.5 Lbs
Slender Wheat Grass	Native	2.0 Lbs
Little Bluestem	Pastura	2.0 Lbs
Sand Dropseed	Native	0.5 Lbs
Switch Grass	Nebraska 28	3.0 Lbs
Weeping Love Grass	Morpha	1.0 Lbs

9. EROSION CONTROL MEASURES OWNER / OPERATED BY ANOTHER ENTITY:

This project outfalls to an existing detention pond, Falcon Meadows on the south side of Woodmen Road owned or operated by another entity.

confirm



**Latigo Business Center Filing
No. 1
Bent Grass Meadows Drive
VICINITY MAP**

Project No:	Falcon Storage
Drawn By:	RAG
Checked By:	
Date:	3/30/2021

Falcon Storage
4615 Northpark Dr., Ste.
101
Colorado Springs, 80918
719-593-1330

MAJOR BASIN	SUB BASIN	AREA		BASIN		T _c MIN	I in./hr.		SOIL GRP	DEV. TYPE	C		FLOW		RETURN PERIOD -years-	
		PLANIM READ	ACRES	LENGTH -FT.-	HEIGHT -FT.-						5-ry qp -CFS-	100-yr qp -CFS-				
FALCON	0-1	9.75	2.47	300	4.5	27			A	SF 5AC.	0.12	0.39				
			V=0.82	+480	1.3	+10										
						37	2.1	3.6					0.62	3.5	5	100
HISTORIC	A	COGO	5.00	+525	9	+13										
			V=0.65			50	1.8	2.8	A	R/L	0.08	0.35				
	TOTAL		7.47							MIX	0.093	0.362	1.25	7.6	5	100
DEVELOPED	A	COGO	1.68	300	2.5	15.2			A	GRAVEL	0.59	0.70			5	100
			V=3.06	+300	7	+1.6										
						16.8	3.2	5.5					3.2	6.5	5	100
	O1 + A	(DP-1)	4.15	=400	8	+2	3.2	5.5	A	MIX	0.310	0.516				
			V=2.82			52	1.7	2.9					2.1	6.2	5	100
	B	COGO	0.66	370	2.4	16.4			A	GRAVEL	0.59	0.70	1.3	2.5	5	100
	C	COGO	2.30	300	4	14.5			A	GRAVEL	0.59	0.70				
			V=2.66	+340	6	+2.1										
						16.6	3.3	5.5					4.5	8.9	5	100
	B+C			+360	8	+2.7										
		(DP-2)	2.96			19.3	3.0	5.1	A	GRAVEL	0.59	0.70	5.2	10.4	5	100
	D	COGO	0.36	240	4.5	11.6	3.8	6.4	A	GRAVEL	0.59	0.70	0.8	1.6	5	100
	B+C+D		V=2.22	+50		+0.4										
		(DP-3)	3.32			19.7	3.0	5.1	A	GRAVEL	0.59	0.70	5.9	11.9	5	100
	+0-1+A		7.47	+240	2.4	+2										
						54	1.7	2.8	A	MIX	0.434	0.598	5.5	12.5	5	100

HYDROLOGICAL COMPUTATION - BASIC DATA
 PROJ: FALCON STORAGE SUB BY: O.E. WATTS
 RATIONAL METHOD DATE: 2/4/21 10/17/22 11-21-21

OLIVER E. WATTS, CONSULTING ENGINEER, INC.
 614 ELKTON DRIVE COLORADO SPRINGS, CO 80907

National Flood Hazard Layer FIRMMette



104°37'51"W 38°56'56"N



Legend

SEE FIS REPORT FOR DETAILED LEGEND AND INDEX MAP FOR FIRM PANEL LAYOUT

- | | | |
|------------------------------------|--|--|
| SPECIAL FLOOD HAZARD AREAS | | Without Base Flood Elevation (BFE)
<i>Zone A, V, A99</i> |
| | | With BFE or Depth <i>Zone AE, AO, AH, VE, AR</i> |
| | | Regulatory Floodway |
| OTHER AREAS OF FLOOD HAZARD | | 0.2% Annual Chance Flood Hazard, Areas of 1% annual chance flood with average depth less than one foot or with drainage areas of less than one square mile <i>Zone X</i> |
| | | Future Conditions 1% Annual Chance Flood Hazard <i>Zone X</i> |
| | | Area with Reduced Flood Risk due to Levee. See Notes. <i>Zone X</i> |
| | | Area with Flood Risk due to Levee <i>Zone D</i> |
| OTHER AREAS | | NO SCREEN Area of Minimal Flood Hazard <i>Zone X</i> |
| | | Effective LOMRs |
| | | Area of Undetermined Flood Hazard <i>Zone D</i> |
| GENERAL STRUCTURES | | Channel, Culvert, or Storm Sewer |
| | | Levee, Dike, or Floodwall |
| OTHER FEATURES | | B 20.2 Cross Sections with 1% Annual Chance Water Surface Elevation
17.5 |
| | | Coastal Transect |
| | | Base Flood Elevation Line (BFE) |
| | | Limit of Study |
| | | Jurisdiction Boundary |
| | | Coastal Transect Baseline |
| | | Profile Baseline |
| | | Hydrographic Feature |
| MAP PANELS | | Digital Data Available |
| | | No Digital Data Available |
| | | Unmapped |



The pin displayed on the map is an approximate point selected by the user and does not represent an authoritative property location.

This map complies with FEMA's standards for the use of digital flood maps if it is not void as described below. The basemap shown complies with FEMA's basemap accuracy standards

The flood hazard information is derived directly from the authoritative NFHL web services provided by FEMA. This map was exported on 3/25/2021 at 9:47 AM and does not reflect changes or amendments subsequent to this date and time. The NFHL and effective information may change or become superseded by new data over time.

This map image is void if the one or more of the following map elements do not appear: basemap imagery, flood zone labels, legend, scale bar, map creation date, community identifiers, FIRM panel number, and FIRM effective date. Map images for unmapped and unmodernized areas cannot be used for regulatory purposes.

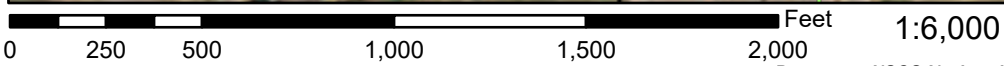

104°37'13"W 38°56'28"N

Hydrologic Soil Group—El Paso County Area, Colorado



OLIVER E. WATTS
CONSULTING ENGINEER, INC.
COLORADO SPRINGS

FALCON STORAGE SUBDIVISION
SCS SOILS MAP

Map Scale: 1:15,900 if printed on A portrait (8.5" x 11") sheet

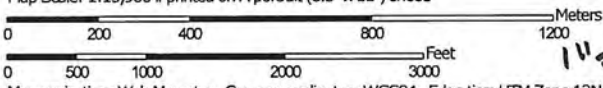

1" = 1380'

EL PASO COUNTY AREA, COLORADO

TABLE 16.--SOIL AND WATER FEATURES

[Absence of an entry indicates the feature is not a concern. See "flooding" in Glossary for definition of terms as "rare," "brief," and "very brief." The symbol > means greater than]

Soil name and map symbol	Hydro-logic group	Flooding			Bedrock		Potential frost action
		Frequency	Duration	Months	Depth	Hardness	
Alamosa: 1-----	C	Frequent-----	Brief-----	May-Jun	In >60	---	High.
Ascalon: 2, 3-----	B	None-----	---	---	>60	---	Moderate.
Badland: 4-----	D	---	---	---	---	---	---
Bijou: 5, 6, 7-----	B	None-----	---	---	>60	---	Low.
Blakeland: 8-----	A	None-----	---	---	>60	---	Low.
19: Blakeland part-	A	None-----	---	---	>60	---	Low.
Fluvaquent Haplaquolls part-----	D	Common-----	Very brief----	Mar-Aug	>60	---	High.
Blendon: 10-----	B	None-----	---	---	>60	---	Moderate.
Bresser: 11, 12, 13-----	B	None-----	---	---	>60	---	Low.
Brussett: 14, 15-----	B	None-----	---	---	>60	---	Moderate.
Chaseville: 16, 17-----	A	None-----	---	---	>60	---	Low.
118: Chaseville part	A	None-----	---	---	>60	---	Low.
Midway part----	D	None-----	---	---	10-20	Rippable	Moderate.
Columbine: 19-----	A	None to rare	---	---	>60	---	Low.
Connerton: 120: Connerton part-	B	None-----	---	---	>60	---	High.
Rock outcrop part-----	D	---	---	---	---	---	---
Cruckton: 21-----	B	None-----	---	---	>60	---	Moderate.
Cushman: 22, 23-----	C	None-----	---	---	20-40	Rippable	Moderate.
124: Cushman part----	C	None-----	---	---	20-40	Rippable	Moderate.
Kutch part-----	C	None-----	---	---	20-40	Rippable	Moderate.
Elbeth: 25, 26-----	B	None-----	---	---	>60	---	Moderate.
127: Elbeth part----	B	None-----	---	---	>60	---	Moderate.

See footnote at end of table.

Table 6-6. Runoff Coefficients for Rational Method
(Source: UDFCD 2001)

Land Use or Surface Characteristics	Percent Impervious	Runoff Coefficients											
		2-year		5-year		10-year		25-year		50-year		100-year	
		HSG A&B	HSG C&D	HSG A&B	HSG C&D	HSG A&B	HSG C&D	HSG A&B	HSG C&D	HSG A&B	HSG C&D	HSG A&B	HSG C&D
Business													
Commercial Areas	95	0.79	0.80	0.81	0.82	0.83	0.84	0.85	0.87	0.87	0.88	0.88	0.89
Neighborhood Areas	70	0.45	0.49	0.49	0.53	0.53	0.57	0.58	0.62	0.60	0.65	0.62	0.68
Residential													
1/8 Acre or less	65	0.41	0.45	0.45	0.49	0.49	0.54	0.54	0.59	0.57	0.62	0.59	0.65
1/4 Acre	40	0.23	0.28	0.30	0.35	0.36	0.42	0.42	0.50	0.46	0.54	0.50	0.58
1/3 Acre	30	0.18	0.22	0.25	0.30	0.32	0.38	0.39	0.47	0.43	0.52	0.47	0.57
1/2 Acre	25	0.15	0.20	0.22	0.28	0.30	0.36	0.37	0.46	0.41	0.51	0.46	0.56
1 Acre	20	0.12	0.17	0.20	0.26	0.27	0.34	0.35	0.44	0.40	0.50	0.44	0.55
Industrial													
Light Areas	80	0.57	0.60	0.55	0.63	0.63	0.66	0.66	0.70	0.68	0.72	0.70	0.74
Heavy Areas	90	0.71	0.73	0.73	0.75	0.75	0.77	0.78	0.80	0.80	0.82	0.81	0.83
Parks and Cemeteries													
Playgrounds	7	0.05	0.09	0.12	0.19	0.20	0.29	0.30	0.40	0.34	0.46	0.39	0.52
Railroad Yard Areas	13	0.07	0.13	0.16	0.23	0.24	0.31	0.32	0.42	0.37	0.48	0.41	0.54
Railroad Yard Areas													
40	0.23	0.28	0.30	0.35	0.36	0.42	0.42	0.50	0.46	0.54	0.50	0.58	
Undeveloped Areas													
Historic Flow Analysis-- Greenbelts, Agriculture	2	0.03	0.05	0.09	0.16	0.17	0.26	0.26	0.38	0.31	0.45	0.36	0.51
Pasture/Meadow	0	0.02	0.04	0.08	0.15	0.15	0.25	0.25	0.37	0.30	0.44	0.35	0.50
Forest	0	0.02	0.04	0.08	0.15	0.15	0.25	0.25	0.37	0.30	0.44	0.35	0.50
Exposed Rock	100	0.89	0.89	0.90	0.90	0.92	0.92	0.94	0.94	0.95	0.95	0.96	0.96
Offsite Flow Analysis (when landuse is undefined)	45	0.26	0.31	0.32	0.37	0.38	0.44	0.44	0.51	0.48	0.55	0.51	0.59
Streets													
Paved	100	0.89	0.89	0.90	0.90	0.92	0.92	0.94	0.94	0.95	0.95	0.96	0.96
Gravel	80	0.57	0.60	0.59	0.63	0.63	0.66	0.66	0.70	0.68	0.72	0.70	0.74
Drive and Walks													
100	0.89	0.89	0.90	0.90	0.92	0.92	0.94	0.94	0.95	0.95	0.96	0.96	
Roofs													
90	0.71	0.73	0.73	0.75	0.75	0.77	0.78	0.80	0.80	0.82	0.81	0.83	
Lawns													
0	0.02	0.04	0.08	0.15	0.15	0.25	0.25	0.37	0.30	0.44	0.35	0.50	

3.2 Time of Concentration

One of the basic assumptions underlying the Rational Method is that runoff is a function of the average rainfall rate during the time required for water to flow from the hydraulically most remote part of the drainage area under consideration to the design point. However, in practice, the time of concentration can be an empirical value that results in reasonable and acceptable peak flow calculations.

For urban areas, the time of concentration (t_c) consists of an initial time or overland flow time (t_i) plus the travel time (t_t) in the storm sewer, paved gutter, roadside drainage ditch, or drainage channel. For non-urban areas, the time of concentration consists of an overland flow time (t_i) plus the time of travel in a concentrated form, such as a swale or drainageway. The travel portion (t_t) of the time of concentration can be estimated from the hydraulic properties of the storm sewer, gutter, swale, ditch, or drainageway. Initial time, on the other hand, will vary with surface slope, depression storage, surface cover, antecedent rainfall, and infiltration capacity of the soil, as well as distance of surface flow. The time of concentration is represented by Equation 6-7 for both urban and non-urban areas.

$$t_c = t_i + t_t \quad (\text{Eq. 6-7})$$

Where:

t_c = time of concentration (min)

t_i = overland (initial) flow time (min)

t_t = travel time in the ditch, channel, gutter, storm sewer, etc. (min)

3.2.1 Overland (Initial) Flow Time

The overland flow time, t_i , may be calculated using Equation 6-8.

$$t_i = \frac{0.395(1.1 - C_s)\sqrt{L}}{S^{0.33}} \quad (\text{Eq. 6-8})$$

Where:

t_i = overland (initial) flow time (min)

C_s = runoff coefficient for 5-year frequency (see Table 6-6)

L = length of overland flow (300 ft maximum for non-urban land uses, 100 ft maximum for urban land uses)

S = average basin slope (ft/ft)

Note that in some urban watersheds, the overland flow time may be very small because flows quickly concentrate and channelize.

3.2.2 Travel Time

For catchments with overland and channelized flow, the time of concentration needs to be considered in combination with the travel time, t_t , which is calculated using the hydraulic properties of the swale, ditch, or channel. For preliminary work, the overland travel time, t_t , can be estimated with the help of Figure 6-25 or Equation 6-9 (Guo 1999).

$$V = C_v S_w^{0.5} \quad (\text{Eq. 6-9})$$

Where:

V = velocity (ft/s)

C_v = conveyance coefficient (from Table 6-7)

S_w = watercourse slope (ft/ft)

Table 6-7. Conveyance Coefficient, C_v

Type of Land Surface	C_v
Heavy meadow	2.5
Tillage/field	5
Riprap (not buried)*	6.5
Short pasture and lawns	7
Nearly bare ground	10
Grassed waterway	15
Paved areas and shallow paved swales	20

* For buried riprap, select C_v value based on type of vegetative cover.

The travel time is calculated by dividing the flow distance (in feet) by the velocity calculated using Equation 6-9 and converting units to minutes.

The time of concentration (t_c) is then the sum of the overland flow time (t_o) and the travel time (t_t) per Equation 6-7.

3.2.3 First Design Point Time of Concentration in Urban Catchments

Using this procedure, the time of concentration at the first design point (typically the first inlet in the system) in an urbanized catchment should not exceed the time of concentration calculated using Equation 6-10. The first design point is defined as the point where runoff first enters the storm sewer system.

$$t_c = \frac{L}{180} + 10 \quad (\text{Eq. 6-10})$$

Where:

t_c = maximum time of concentration at the first design point in an urban watershed (min)

L = waterway length (ft)

Equation 6-10 was developed using the rainfall-runoff data collected in the Denver region and, in essence, represents regional “calibration” of the Rational Method. Normally, Equation 6-10 will result in a lesser time of concentration at the first design point and will govern in an urbanized watershed. For subsequent design points, the time of concentration is calculated by accumulating the travel times in downstream drainageway reaches.

3.2.4 Minimum Time of Concentration

If the calculations result in a t_c of less than 10 minutes for undeveloped conditions, it is recommended that a minimum value of 10 minutes be used. The minimum t_c for urbanized areas is 5 minutes.

3.2.5 Post-Development Time of Concentration

As Equation 6-8 indicates, the time of concentration is a function of the 5-year runoff coefficient for a drainage basin. Typically, higher levels of imperviousness (higher 5-year runoff coefficients) correspond to shorter times of concentration, and lower levels of imperviousness correspond to longer times of

Figure 6-5. Colorado Springs Rainfall Intensity Duration Frequency

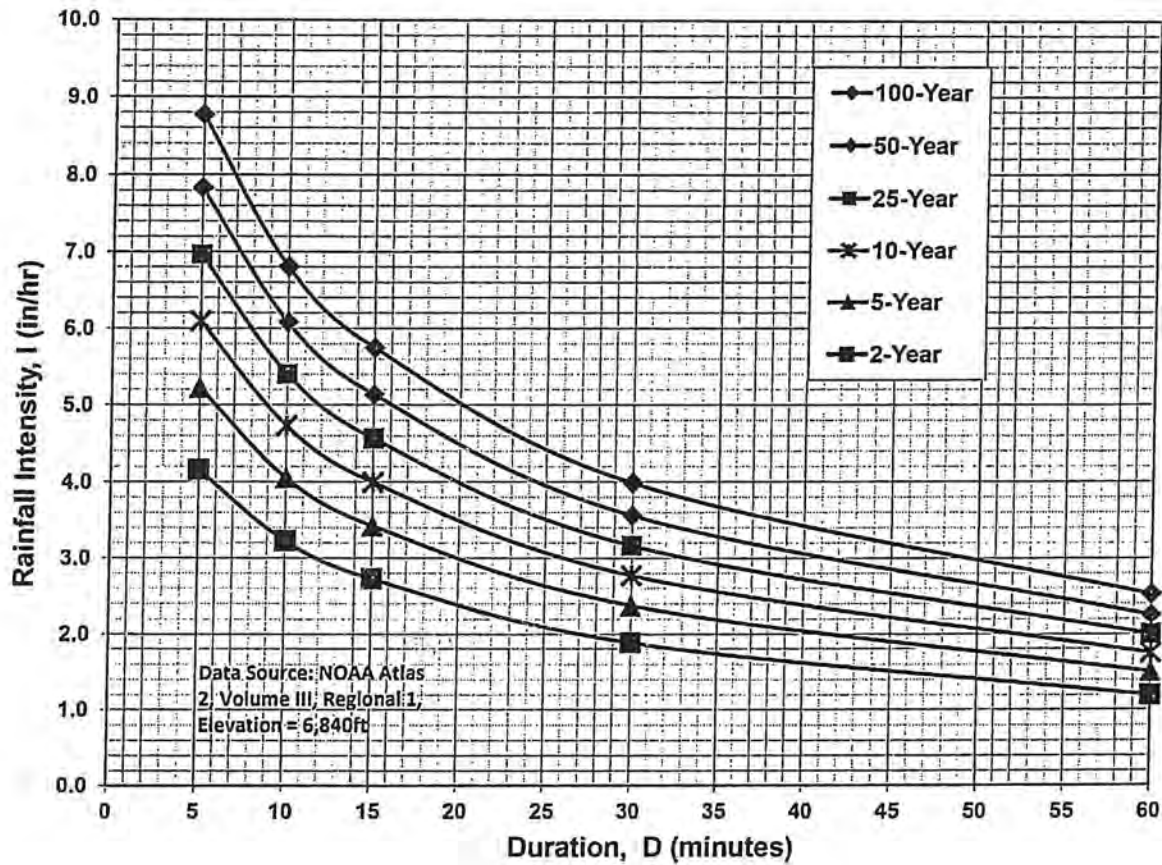

IDF Equations

$$I_{100} = -2.52 \ln(D) + 12.735$$

$$I_{50} = -2.25 \ln(D) + 11.375$$

$$I_{25} = -2.00 \ln(D) + 10.111$$

$$I_{10} = -1.75 \ln(D) + 8.847$$

$$I_5 = -1.50 \ln(D) + 7.583$$

$$I_2 = -1.19 \ln(D) + 6.035$$

Note: Values calculated by equations may not precisely duplicate values read from figure.

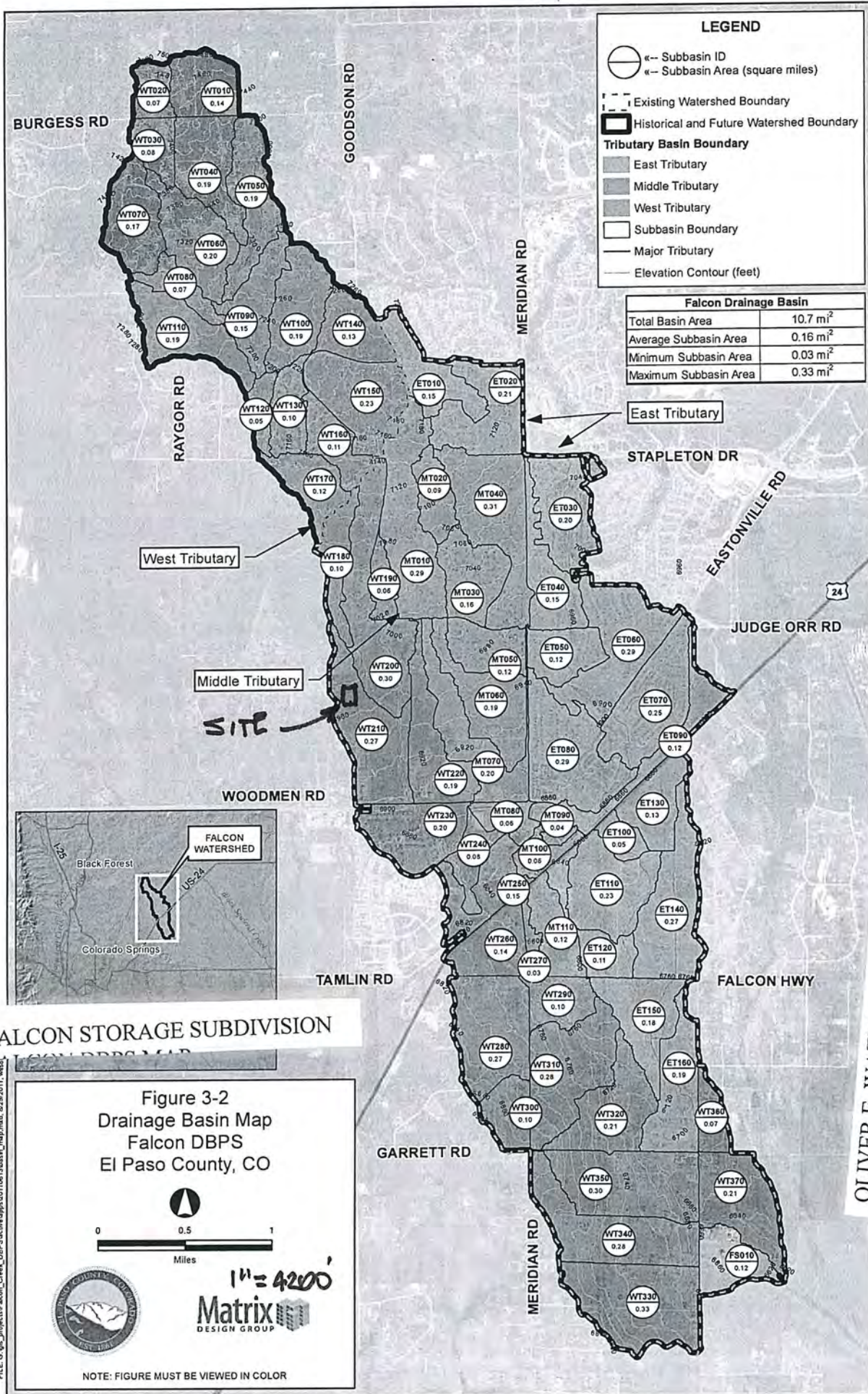



PRIVATE DETENTION BASIN MAINTENANCE AND EASEMENT AGREEMENT

This PRIVATE DETENTION BASIN MAINTENANCE AND EASEMENT AGREEMENT ("Agreement"), is made by and among THE BOARD OF COUNTY COMMISSIONERS OF EL PASO COUNTY, COLORADO ("Board" or "County"), VERNIE HOUTCHENS, GARY L. NANNINGA (collectively, "Owners"), and RANDY DEYOUNG ("DeYoung"), and LATIGO BUSINESS CENTER OWNERS ASSOCIATION, a Colorado nonprofit corporation (the "Association"). The above may occasionally be referred to herein singularly as a "Party" and collectively as the "Parties." This Agreement is consented to by Falcon School District No. 49, whose rights under this Agreement are set forth in Section 16.a. below.

Recitals

1. WHEREAS, Owners are the owners of certain real property in El Paso County, Colorado, legally described in **Exhibit A** attached hereto and incorporated by reference (the "Property"); and
2. WHEREAS, Owners desire to plat and develop on the Property a subdivision to be known as Latigo Business Center; and
3. WHEREAS, the development of the Property will substantially increase the volume of water runoff from the Property, and, therefore, it is in the interest of public health, safety and welfare for the County to condition approval of the subdivision of the Property on the Owners' promise to construct adequate drainage and water runoff control facilities; and
4. WHEREAS, Chapter V, Section 49.2 of the El Paso County Land Development Code, as periodically amended, promulgated pursuant to Section 30-28-133(1), Colorado Revised Statutes, 2004, as amended, requires the County to condition approval of all subdivisions on the property owner's promise to so construct adequate drainage and water runoff control facilities in subdivisions; and
5. WHEREAS, Section 2.9 of the El Paso County Drainage Criteria Manual provides for a property owner's promise to maintain a subdivision's drainage facility in the event the County does not assume such responsibility; and
6. WHEREAS, property owners in El Paso County have historically chosen water runoff detention ponds as a means to provide adequate drainage and water runoff control in subdivisions, which basins, while effective, are less expensive for property owners to construct than other methods of providing drainage and water runoff control; and
7. WHEREAS, pursuant to a separate agreement between the Owners and DeYoung, DeYoung desires to construct drainage facilities and detention pond as the means for providing adequate drainage and water runoff control in the Property, on the terms contained herein; and,

8. WHEREAS, the Association shall be charged in the subdivision covenants with the duty of cleaning, maintaining, and repairing such detention basins; and,

9. WHEREAS, it is the County's experience that subdivision owners and associations historically have not properly cleaned and otherwise not properly maintained and repaired these detention basins, and that these detention basins, when not so properly cleaned, maintained and repaired, threaten the public health, safety and welfare; and,

10. WHEREAS, the County, in order to so protect the public health, safety and welfare, has historically expended valuable and limited public resources to so clean, maintain and repair these detention basins when owners and associations have failed in their responsibilities, and therefore the County desires to recover its costs incurred in the event the burden falls on the County to so clean, maintain and repair the detention basin in the Subdivision; and,

11. WHEREAS, the County conditions approval of the subdivision of the Property on DeYoung's promise to so construct the detention basin and the Association's promise to maintain the same, and conditions approval on the Association's promise to reimburse the County in the event the burden falls upon the County to so clean, maintain and/or repair the detention basin within the Property; and,

12. WHEREAS, the County could condition subdivision approval on the Owners' and Association's promise to construct a different and more expensive drainage and water runoff control system than that proposed herein, which more expensive system would not create the possibility of the burden of cleaning, maintenance and repair expenses falling on the County; however, the County is willing to forego such right upon the performance of Owners' and the Association's promises contained herein; and

13. WHEREAS, the County, in order to secure performance of the promises contained herein, conditions approval of the subdivision of the Property upon the Owners' grant herein of a perpetual Easement over portions of the Property for the purpose of allowing the County to periodically access, inspect, and, when so necessary, to clean, maintain and/or repair the detention basin; and

14. WHEREAS, given that the Association could potentially avoid liability hereunder by dissolving and reforming as a different entity, and given the difficulties inherent in collecting an unsecured promits, the County, in order to secure performance of the promises contained herein, conditions approval of the subdivision of the Property upon the Owners' creation, by and through this Agreement, of a covenant running with the land upon each and every lot in the subdivision of the Property.

Agreement

NOW, THEREFORE, in consideration of the mutual Promises contained herein, the sufficiency of which are hereby acknowledged, the Parties agree as follows:

1. Incorporation of Recitals: The Parties incorporate the Recitals above into this Agreement.
2. Covenants Running with the Land and Pro Rata Liability upon Individual Lot Owners: Owners. DeYoung and the Association agree that this entire Agreement and the performance thereof shall become a covenant running with the land, which land is legally described in Paragraph 1 of the Recitals set forth above, and that this entire Agreement and the performance thereof shall be binding upon themselves, their respective

successors and assigns, including individual lot owners within the Property.

However, any liability imposed under this Agreement against an individual lot owner shall not be joint and several with the Owners and the Association, but shall be pro rated on a per-lot basis as determined by the following formula and illustration: each individual lot owner(s) shall be liable for no more than the total monetary amount of liability multiplied by a fraction in which the numerator is the number of lots in the subdivision owned by a particular lot owner, and the denominator is the total number of lots in the subdivision. As to any lot(s) owned by more than one person or entity, the liability among co-owners shall be joint and several for the pro rata obligation of that lot. The application of this Paragraph is best illustrated by the following example. Assume the following parameters: total liability is \$10,000; total number of lots in the subdivision is 100; Lot 1 is owned by persons A and B; person B also owns Lot 2. Liability is as follows: the Owners, \$10,000; the Association, \$10,000; Lot 1 is \$100.00, joint and several as to A and B, Lot 2 is \$100.00 owed solely by B. Thus person A's total liability is \$100.00 and person B's is \$200.00. Applying the principle that the County cannot collect more than it is owed, and assuming that the County cannot collect anything from the Owners and the Association, if the County collected the whole \$200.00 from B, then it could not collect the \$100.00 from A. Likewise, if the County collected the \$100.00 from A, then it could only collect \$100.00 from B.

3. Construction: DeYoung agrees that he shall cause the construction of a detention basin and other improvements required for the Property within the tracts legally described on **Exhibit B** attached hereto and incorporated herein by reference (the "Drainage Easements"), to be installed in accordance with the conditions in the finally approved development documents listed on **Exhibit C** attached hereto and incorporated herein by reference, and in accordance with the regulations and requirements of the County (the "Detention Basin"). Construction shall not commence on the Detention Basin until the County Development Services Department has approved in writing the plans and specifications for the Detention Basin. Failure to obtain such approval shall be a material breach of this Agreement, and shall entitle the County to pursue any remedies available to it at law or in equity to enforce the same. Construction of the Detention Basin shall be substantially completed within one (1) year (defined as 365 days), which one year period will commence to run on the date the approved plat for Latigo Business Center Filing No. 1 is recorded in the records of the El Paso County Clerk and Recorder. Rough grading of the Detention Basin must be completed and inspected by the County Development Services Department prior to commencing road construction.

In the event construction is not so substantially completed within the one (1) year period, then the County may exercise its discretion to complete the project, and shall have the right to seek reimbursement from DeYoung, the Owners, and the Association and their successors and assigns, including individual lot owners within the subdivision, for its actual costs and expenses incurred in the process of completing construction. The term "actual costs and expenses" shall be liberally construed in favor of the County, and shall include, but shall not be limited to, labor costs, tool and equipment costs, supply costs, and engineering and design costs, regardless of whether the County uses its own personnel, tools, equipment and supplies, etc. to correct the matter. In the event the County initiates any litigation or engages the services of legal counsel in order to enforce the provisions arising herein, the County shall be entitled to its damages and costs, including reasonable attorney fees, regardless of whether the County contracts with outside legal counsel or utilizes in-house legal counsel for the same. The scope of liability therefor of DeYoung, the Owners, the Association, and the individual lot owners shall be as set forth in paragraph Two (2) above.

4. Maintenance: The Owners, DeYoung, and the Association agree for themselves, their respective successors and assigns, including individual lot owners within the Property, that they will regularly and routinely inspect, clean and maintain the Detention Basin, and otherwise keep the same in good repair, all at their own cost and expense. No trees or shrubs that will impair the structural integrity of the Detention Basin shall be planted or allowed to grow on the Detention Basin.

5. Creation of Easement: Owners and the Association hereby grant the County, DeYoung, and the other Owners and the Association a non-exclusive perpetual easement upon the Drainage Easements. The purpose of the easement is to allow DeYoung to construct Detention Basin and the County and the Association to access, inspect, clean, repair and maintain the Detention Basin; however, the creation of the easement does not expressly or implicitly impose on the County a duty to so inspect, clean, repair or maintain the Detention Basin. The Drainage Easements shall run with the land and burden the Property for the benefit of the County.

6. County's Rights and Obligations: Any time the County determines, in the exercise of its reasonable discretion, that the Detention Basin is not properly cleaned, maintained and/or otherwise kept in good repair, the County shall give reasonable notice to the individual lot owners within the Property and the Owners and the Association and their respective successors and assigns, that the Detention Basin needs to be cleaned, maintained and/or otherwise repaired. The notice shall provide a reasonable time to correct the problem(s). Should the responsible parties fail to correct the specified problem(s), the County may enter upon the property to so correct the specified problem(s). Notice shall be effective to the above by the County's deposit of the same into the regular United States mail, postage pre-paid. However, this Agreement does not expressly impose on the County a duty to so inspect, clean, repair or maintain the Detention Basin.

7. Reimbursement of County's Costs/Covenant Running With the Land: The Owners and the Association agree and covenant, for themselves, their respective successors and assigns, including individual lot owners within the Property, that they will reimburse the County for its costs and expenses incurred in the process of cleaning, maintaining, and/or repairing the Detention Basin. However, the obligation and liability of the Owners hereunder shall only continue until such time as the Owners transfer the entire management and operation of the Association to the individual lot owners within the subdivision. Notwithstanding the previous sentence, the Association and the individual lot owners within the subdivision shall always remain obligated and liable hereunder, and as per the provisions of paragraph Two (2) above.

The term "actual costs and expenses" shall be liberally constructed in favor of the County, and shall include, but shall not be limited to, labor costs, tools and equipment costs, supply costs, and engineering and design costs, regardless of whether the County uses its own personnel, tools, equipment and supplies, etc. to correct the matter. In the event the County initiates any litigation or engages the services of legal counsel in order to enforce the provisions arising herein, the County shall be entitled to its damages and costs, including reasonable attorney's fees, regardless of whether the County contracts with outside legal counsel or utilizes in-house legal counsel for the same. The scope of liability therefor of the Owners, the Association, and the individual lot owners shall be as set forth in Paragraph Two (2) above.

8. Contingencies of Subdivision Approval: Owners' and the Association's execution of this Agreement is a condition of subdivision approval. Additional conditions of this Agreement include, but are not limited to, the following:

- a. Conveyance of Drainage Easements as provided herein; and
- b. The County's receipt of a copy of the Articles of Incorporation for the Association, as filed with the Colorado Secretary of States; receipt of the Certificate of Incorporation or other comparable proof for the same from the Colorado Secretary of State; a copy of the Bylaws of the Association; a copy of the organizational minutes or other appropriate document of the Association, properly executed and attested, establishing that the Association has adopted this Agreement as an obligation of the Association; and
- c. A copy of the Covenants establishing that the Association is obligated to inspect, clean, maintain, and repair the Detention Basin; that the Association has adopted this Agreement as an obligation of the Association; and that a funding mechanism is in place whereby individual lot owners within the Property will pay a regular fee to the Association for, among other matters, the inspection, cleaning, maintenance, and repair of the Detention Basin.
- d. A copy of the Covenants establishing that this Agreement is incorporated into the Covenants, and that such Agreement touches and concerns each and every lot within the Property.

The County shall have the right, in the sole exercise of its discretion, to approve or disapprove any documentation submitted to it under the conditions of this paragraph. The County's rejection of any documentation submitted hereunder shall mean that the appropriate condition of this Agreement has not been fulfilled.

9. Distribution to Lot Purchasers. Upon the initial sale of any lot within the subdivision, prior to closing on such sale, the Owners shall give a copy of this Agreement to the potential buyer.

10. Agreement Monitored by Development Services Department: Any and all actions and decisions to be made hereunder by the County shall be made by the director of the El Paso County Development Services Department. Accordingly, any and all documents, submissions, plan approval, inspections, etc. shall be submitted to and shall be made by the Director of the Development Services Department.

11. Indemnification and Hold Harmless: To the extent authorized by law, Owners and the Association agree, for themselves, their respective successors and assigns, including the individual lot owners in the Property, that they will indemnify, defend, and hold the County harmless from any and all loss, costs, damage, injury, liability, claim, lien, demand, action and causes of action whatsoever, whether at law or in equity, arising from or related to their respective intentional or negligent acts, errors or omissions or that of its agents, officers, servants, employees, invitees and licensees in the construction, operation, inspection, cleaning (including analyzing and disposing of any solid or hazardous wastes as defined by State and/or Federal environmental laws and regulations), maintenance, and repair of the Detention Basin, and such obligation arising under this paragraph shall be joint and several, subject to paragraph 2 herein. Nothing in this paragraph shall be deemed to waive or otherwise limit the defense available to the County pursuant to the Colorado Governmental Immunity Act, Sections 24-10-101, *et seq.* C.R.S. 2004, as amended, or as otherwise provided by law. However, the obligation and liability of the Owners hereunder shall only continue until such time as the Owners transfer the entire management and operation of the Association to the individual lot owners within the Property.

12. Severability: In the event any Court of competent jurisdiction declares any part of this

Agreement to be unenforceable, such declaration shall not affect the enforceability of the remaining parts of this Agreement.

13. Third Parties: This Agreement does not and shall not be deemed to confer upon or grant to any third party any right to claim damages or to bring any lawsuit, action or other proceeding against either the County, the Owners or the Association, their respective successors and assigns, including any individual lot owners in the Property, because of any breach hereof or because of any terms, covenants, agreements or conditions contained herein.

14. Solid or Hazardous Wastes: Should any refuse from the detention basin be suspected or identified as solid waste and/or hazardous waste, the Owners and the Association shall take all necessary and proper steps to characterize the waste and properly dispose of it in accordance with applicable State and/or Federal environmental laws and regulations, including, but not limited to, the following: Solid Wastes Disposal Sites and Facilities Acts, §§ 30-20-100.5 – 30-20-119, C.R.S. (2002) as amended, Colorado Regulations Pertaining to Solid Waste Disposal Sites and Facilities, 6 C.C.R. 1007-2, *et seq.*, as amended, Solid Waste Disposal Act, 42 U.S.C. §§ 6901-6992k (2004) as amended, and Federal Solid Waste Regulations 40 CFR Ch. I (2004) as amended. The County shall not be responsible or liable for identifying, characterizing, cleaning up, or disposing of such solid and/or hazardous waste. Notwithstanding the previous sentence, should any refuse cleaned up and disposed of by the County be determined to be solid and/or hazardous waste, the Owners and the Association, but not the County, shall be responsible and liable as the owner, generator, and/or transporter of said solid and/or hazardous waste.

15. Applicable Law and Venue: The laws, rules, and regulations of the State of Colorado and El Paso County shall be applicable in the enforcement, interpretation, and execution of this Agreement, except that Federal law may be applicable regarding solid or hazardous wastes. Venue shall be in the El Paso County District Court.

16. Exclusion from the Obligations of this Agreement.

(a) Notwithstanding any other provision of this Agreement, the Parties acknowledge and agree that the certain real property owned by Falcon School District No. 49, to be described as Lot 2, Latigo Business Center Filing No. 1, adjacent to the Property, may be benefitted by the Detention Basin, but is excluded and free from the provisions of this Agreement, shall not be considered or made a part hereof, shall be excluded from all obligations as an "Owner" or "lot" hereunder, and shall not be liable for any costs or charges hereunder.

(b) Notwithstanding any other provision of this Agreement, DeYoung and the County acknowledge and agree that the Owners (or their successors and assigns) shall not be liable to the County for any costs or charges hereunder, or responsible for any obligations under this Agreement, until such time as those portions of the Property, other than that portion of the Property to be described as Lot 1, Latigo Business Center Filing No. 1, are platted and a plat for such portions has been recorded in the real property records of the El Paso County Clerk and Recorder's office. Notwithstanding the previous sentence, the Association and the individual lot owners within the Property shall always remain obligated and liable hereunder, and as per the provisions of Paragraph Two (2) above.

IN WITNESS WHEREOF, the Parties affix their signatures below.

Executed this 8 day of MARCH, 2005, by:

VERNIE HOUTCHENS

STATE OF COLORADO)
) ss.
COUNTY OF EL PASO)

This instrument was acknowledged before me on March 8, 2005 by Vernie Houtchens.

Witness my hand and official seal.
My commission expires GIBSON 06
[SEAL] NOTARY PUBLIC
STATE OF COLORADO
My Commission Expires 07/02/2006

Sally J. Gibson
Notary Public

Gary L. Nanninga
GARY L. NANNINGA

STATE OF COLORADO)
) ss.
COUNTY OF EL PASO)

This instrument was acknowledged before me on March 8, 2005 by Gary L. Nanninga.

Witness my hand and official seal.

My commission expires 7/2/06
[SEAL] SALLY J. GIBSON
NOTARY PUBLIC
STATE OF COLORADO
My Commission Expires 07/02/2006

Sally J. Gibson
Notary Public

Randy DeYoung
RANDY DEYOUNG

STATE OF COLORADO)
) ss.
COUNTY OF EL PASO)

This instrument was acknowledged before me on MAY 3, 2005 by Randy DeYoung.

Witness my hand and official seal.

My commission expires
[SEAL] MY COMMISSION EXPIRES
02/13/2005
Notary Public

[Signature]
Notary Public

LATIGO BUSINESS CENTER OWNERS ASSOCIATION,
a Colorado nonprofit corporation

By: Gary L. Nanninga
President

STATE OF COLORADO)
) ss.

COUNTY OF EL PASO)

This instrument was acknowledged before me on March 8, 2005 by GARY L. NANNINGA, as President of Latigo Business Center Owners Association, a Colorado nonprofit corporation.

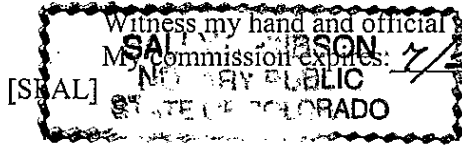

Sally J. Nelson
Notary Public

My Commission Expires: 07/02/2006

**BOARD OF COUNTY COMMISSIONERS
OF EL PASO COUNTY, COLORADO**

By: [Signature]
_____, Chairperson ~~men~~

Attest:
[Signature]
Deputy Clerk

Approved as to Content and Form:
M. Cole Emmons
Assistant County Attorney

LIST OF EXHIBITS

- Exhibit A - Property
- Exhibit B - Drainage Easements
- Exhibit C - Development Documents



LDC, Inc.

3520 AUSTIN BLUFFS PARKWAY
COLORADO SPRINGS, CO 80918

(719) 528-6133

FAX (719) 528-6848

www ldc-inc.com

LATIGO BUSINESS CENTER

Project No. 01081

January 19, 2005

Sheet 1 of 2

EXHIBIT "A"

PROPERTY DESCRIPTION: OVERALL PARCEL EXCLUDING SCHOOL DISTRICT LOT 2

A parcel of land being a portion of the Southwest One-Quarter of Section 1, Township 13 South, Range 65 West of the 6th P.M., including proposed Lot 1 and proposed Bentgrass Meadows Boulevard (80' r.o.w.), LATIGO BUSINESS CENTER FILING NO. 1 (recording pending), situate in El Paso County, Colorado, described as follows:

Commencing at the Southwest corner of said Section 1's Southwest One-Quarter (all bearings in this description are relative to the South line of said Section 1, which bears S89°42'50"E "assumed"), said corner also being the Southwest corner of said FILING; thence N00°16'02"E along the West line of said Southwest One-Quarter, said line also being coincident with the Westerly line of said FILING, 30.00 feet to a point on the Northerly right-of-way line of Woodmen Road (60' r.o.w.), said point also being on the Southerly line of proposed Lot 2, said FILING (the following four (4) courses are along the lines of said Lot 2); 1) S89°42'50"E along said Woodmen Road's Northerly right-of-way line, 406.84 feet to the Point of Beginning of the parcel herein described; 2) on a non-tangent curve to the left, said curve having a central angle of 18°46'08", a radius of 49.00 feet, an arc length of 16.05 feet (the chord to said curve bears N55°42'50"E, a distance of 15.98 feet); 3) N00°16'02"E, 1047.52 feet; 4) N89°42'50"W, 420.00 feet to a point on said FILING's Westerly line; thence N00°16'02"E along said Westerly line, 842.00 feet to the Northwest corner of said FILING; thence S89°42'50"E along the Northerly line of said FILING and its Easterly extension, 1690.72 feet to a point on the Easterly line of that Ingress/Egress and Utility Easement described by document (Book 3265, Page 517, El Paso County, Colorado records) (the following five (5) courses are along the lines of said Easement); 1) S00°07'47"W, 1180.41 feet; 2) on a curve to the left, said curve having a central angle of 25°15'43", a radius of 490.87 feet, an arc length of 216.43 feet; 3) S25°07'56"E, 365.00 feet; 4) on a curve to the right, said curve having a central angle of 25°25'06", a radius of 266.04 feet, an arc length of 118.02 feet; 5) S00°17'10"W, 65.00 feet to a point on said Woodmen Road's Northerly right-of-way line; thence N89°42'50"W along said Northerly right-of-way line, 1503.26 feet to the Point of Beginning;

Containing 65.593 acres, more or less.

SURVEYOR'S STATEMENT:

I, David V. Hostetler, a registered Professional Land Surveyor in the State of Colorado, do hereby state that the attached LEGAL DESCRIPTION and EXHIBIT were prepared under my direct responsibility, supervision and checking, and on the basis of my knowledge, information and belief, are correct.

David V. Hostetler, Professional Land Surveyor
Colorado P.L.S. No. 20681
For and on behalf of LDC, Inc.

File: 01081 Overall EXCEPT Lot 2.doc
DVH/dh



LEGAL DESCRIPTION EXHIBIT

A PORTION OF THE SOUTHWEST ONE-QUARTER OF SECTION 1, T13S, R65W OF THE 6TH P.M., EL PASO COUNTY, COLORADO

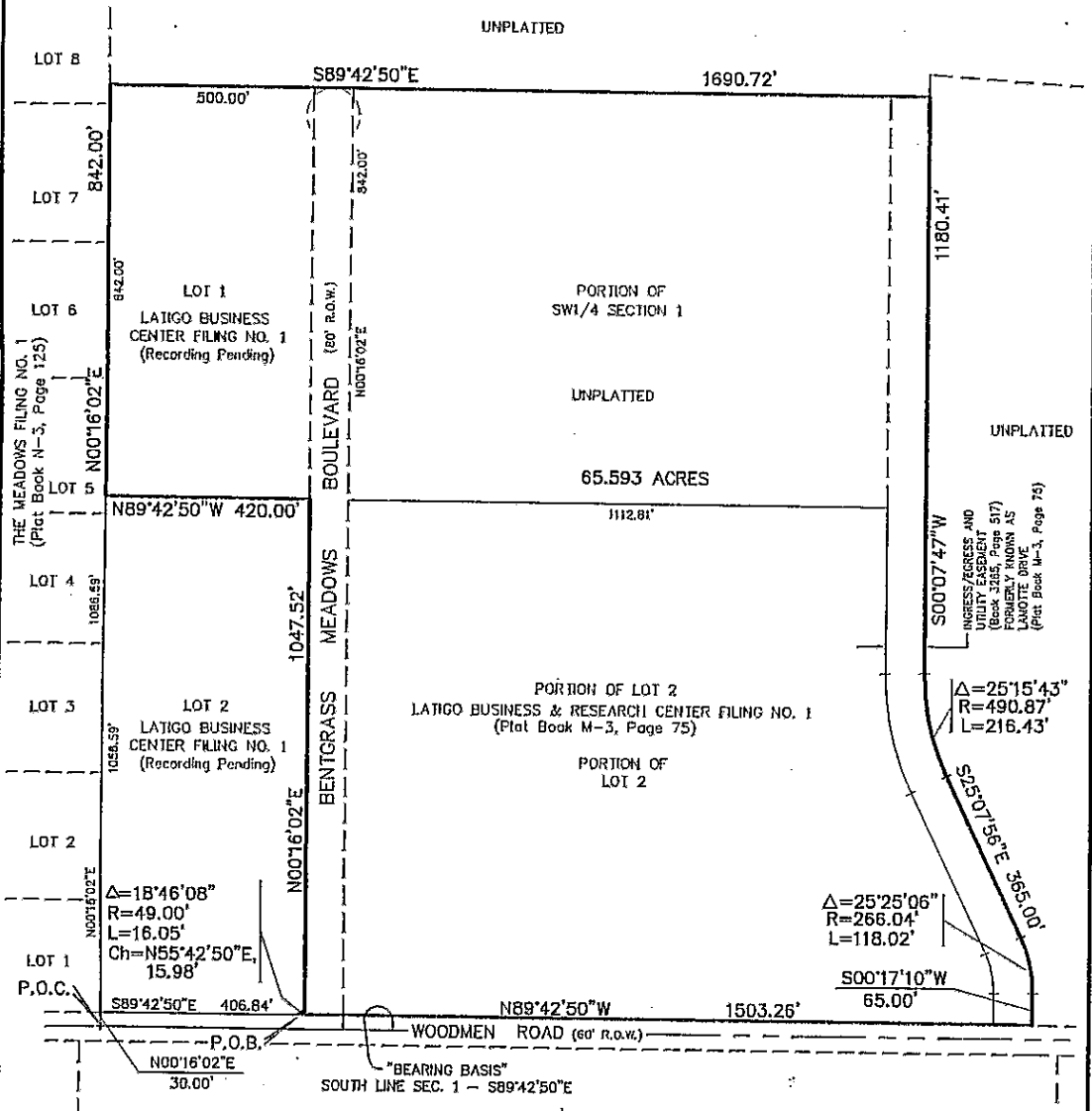

EXHIBIT "B"
SHEET 2 OF 2

LDC, Inc.
PLANNING, SURVEYING, LANDSCAPE ARCHITECTURE
3520 AUSTIN BLUFFS PARKWAY
COLORADO SPRINGS, CO. 80918
(719) 528-6133
FAX (719) 528-6848

DWN BY: RDG DATE: 01/18/05
CK'D BY: REF. NO.: 01081P2

NOTE:
This EXHIBIT does not represent a monumented land survey, and is only intended to depict the attached LEGAL DESCRIPTION.

REVISIONS			
NO.	DESCRIPTION	DATE	BY
PROJECT NUMBER 01081			

F:\0100001081 - ANDREWS\01081P2.dwg, 63 ACRE EXHIBIT, 1/19/2005 9:21:26 AM

EXHIBIT B

Exhibit B consists of legal descriptions for three (3) different drainage tracts as described on the following 6 pages.



LDC, Inc.

3520 AUSTIN BLUFFS PARKWAY
COLORADO SPRINGS, CO 80918
(719) 528-6133
FAX (719) 528-6848
www ldc-inc.com

LATIGO BUSINESS CENTER
Project No. 01081
December 17, 2004
Sheet 1 of 2

EXHIBIT "A"

LEGAL DESCRIPTION: A tract of land being a portion of the Southwest One-Quarter of Section 1, Township 13 South, Range 65 West of the 6th P.M., known as Lot 2, LATIGO BUSINESS & RESEARCH CENTER FILING NO. 1 (Plat Book M-3, Page 75, El Paso County, Colorado records), situate in El Paso County, Colorado.

EXHIBIT "B"

LEGAL DESCRIPTION: TEMPORARY DRAINAGE EASEMENT

A TEMPORARY DRAINAGE EASEMENT over and across a portion of the Southwest One-Quarter of Section 1, Township 13 South, Range 65 West of the 6th P.M., also being a portion of Lot 2, LATIGO BUSINESS & RESEARCH CENTER FILING NO. 1 (Plat Book M-3, Page 75, El Paso County, Colorado records), situate in El Paso County, Colorado, described as follows:

Beginning at the Southeast corner of said Lot 2 (all bearings in this description are relative to those platted in said FILING); thence $N00^{\circ}17'10''E$ along the Easterly line of said Lot 2, 65.00 feet; thence on a curve to the left and along said Lot 2's Easterly line, said curve having a central angle of $04^{\circ}47'13''$, a radius of 186.04 feet, an arc length of 15.54 feet; thence $N89^{\circ}42'50''W$, 310.01 feet; thence on a curve to the right, said curve having a central angle of $28^{\circ}33'37''$, a radius of 365.69 feet, an arc length of 182.28 feet; thence on a reverse curve to the left, said curve having a central angle of $28^{\circ}33'37''$, a radius of 515.00 feet, an arc length of 256.71 feet; thence $N89^{\circ}42'50''W$, 148.00 feet; thence on a curve to the left, said curve having a central angle of $29^{\circ}19'56''$, a radius of 515.00 feet, an arc length of 263.65 feet; thence on a reverse curve to the right, said curve having a central angle of $29^{\circ}19'56''$, a radius of 325.00 feet, an arc length of 166.38 feet; thence $N89^{\circ}42'50''W$, 52.09 feet to a point on the Easterly line of proposed LATIGO BUSINESS CENTER FILING NO. 1 (recording pending); thence $S00^{\circ}16'02''W$ along said LATIGO BUSINESS CENTER FILING NO. 1's Easterly line, 80.00 feet to a point on the Southerly line of said Lot 2; thence $S89^{\circ}42'50''E$ along said Lot 2's Southerly line, 1343.26 feet to the Point of Beginning and the terminus point of this description.

SURVEYOR'S STATEMENT:

I, David V. Hostetler, a registered Professional Land Surveyor in the State of Colorado, do hereby state that the attached LEGAL DESCRIPTION and EXHIBIT were prepared under my direct responsibility, supervision, and checking, and on the basis of my knowledge, information and belief, are correct.

David V. Hostetler, Professional Land Surveyor
Colorado P.L.S. No. 20681
For and on behalf of LDC, Inc.

File: Docs/01081/Temp Drainage Easement.doc
DVH/dh

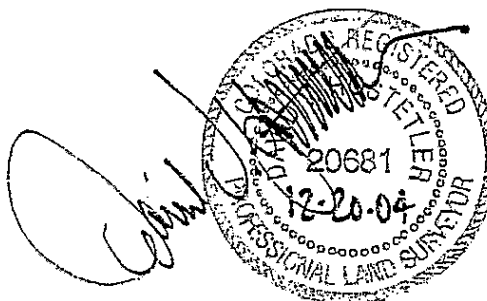



LDC, Inc.

3520 AUSTIN BLUFFS PARKWAY
COLORADO SPRINGS, CO 80918
(719) 528-6133
FAX (719) 528-6848
www ldc-inc.com

LATIGO BUSINESS CENTER
Project No. 01081
December 17, 2004
Sheet 1 of 2

EXHIBIT "A"

LEGAL DESCRIPTION: A tract of land being a portion of the Southwest One-Quarter of Section 1, Township 13 South, Range 65 West of the 6th P.M., described by document (Book 5121, Page 1497, El Paso County, Colorado records), situate in El Paso County, Colorado.

EXHIBIT "B"

LEGAL DESCRIPTION: TEMPORARY DRAINAGE EASEMENT

A TEMPORARY DRAINAGE EASEMENT over and across a portion of the Southwest One-Quarter (SW1/4) of Section 1, Township 13 South, Range 65 West of the 6th P.M., also being a portion of that tract described by document (Book 5121, Page 1497, El Paso County, Colorado records), situate in El Paso County, Colorado, described as follows:

Commencing at the Southwest corner of said Section 1's SW1/4 (all bearings in this description are relative to the South line of said SW1/4, which bears S89°42'50"E "assumed"), said corner also being the Southwest corner of proposed LATIGO BUSINESS CENTER FILING NO. 1 (recording pending); thence S89°42'50"E along said SW1/4's South line, said line also being coincident with the Southerly line of said FILING, 500.00 feet to the Southeast corner of said FILING; thence N00°16'02"E along the Easterly line of said FILING, 1086.59 feet to a point on the Northerly line of Lot 2, LATIGO BUSINESS & RESEARCH CENTER FILING NO. 1 (Plat Book M-3, Page 75, said El Paso County records), said point also being the Point of Beginning of the EASEMENT herein described; thence continue N00°16'02"E along said FILING's Easterly line, 64.87 feet; thence S89°42'50"E, 413.52 feet; thence on a curve to the left, said curve having a central angle of 41°59'28", a radius of 245.00 feet, an arc length of 179.56 feet; thence N48°17'42"E, 336.86 feet; thence S00°07'47"W, 353.14 feet to a point on said Lot 2's Northerly line; thence N89°42'50"W along said Northerly line, 828.74 feet to the Point of Beginning and the terminus point of this description.

SURVEYOR'S STATEMENT:

I, David V. Hostetler, a registered Professional Land Surveyor in the State of Colorado, do hereby state that the attached LEGAL DESCRIPTION and EXHIBIT were prepared under my direct responsibility, supervision, and checking, and on the basis of my knowledge, information and belief, are correct.

David V. Hostetler, Professional Land Surveyor
Colorado P.L.S. No. 20681
For and on behalf of LDC, Inc.

File: Docs/01081/Temp Drainage Easement 1.doc
DVH/dh

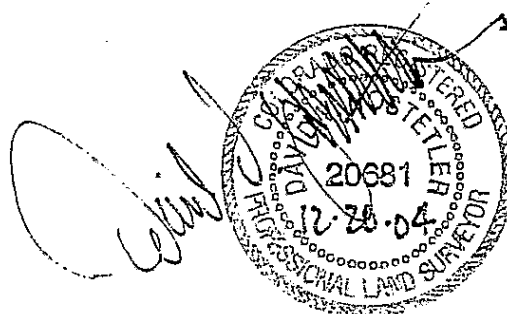

LEGAL DESCRIPTION EXHIBIT

A PORTION OF THE SW1/4 OF SEC. 1, T13S, R65W OF THE 6TH P.M.,
EL PASO COUNTY, COLORADO

UNPLATTED
PORTION OF SW1/4 SECTION 1

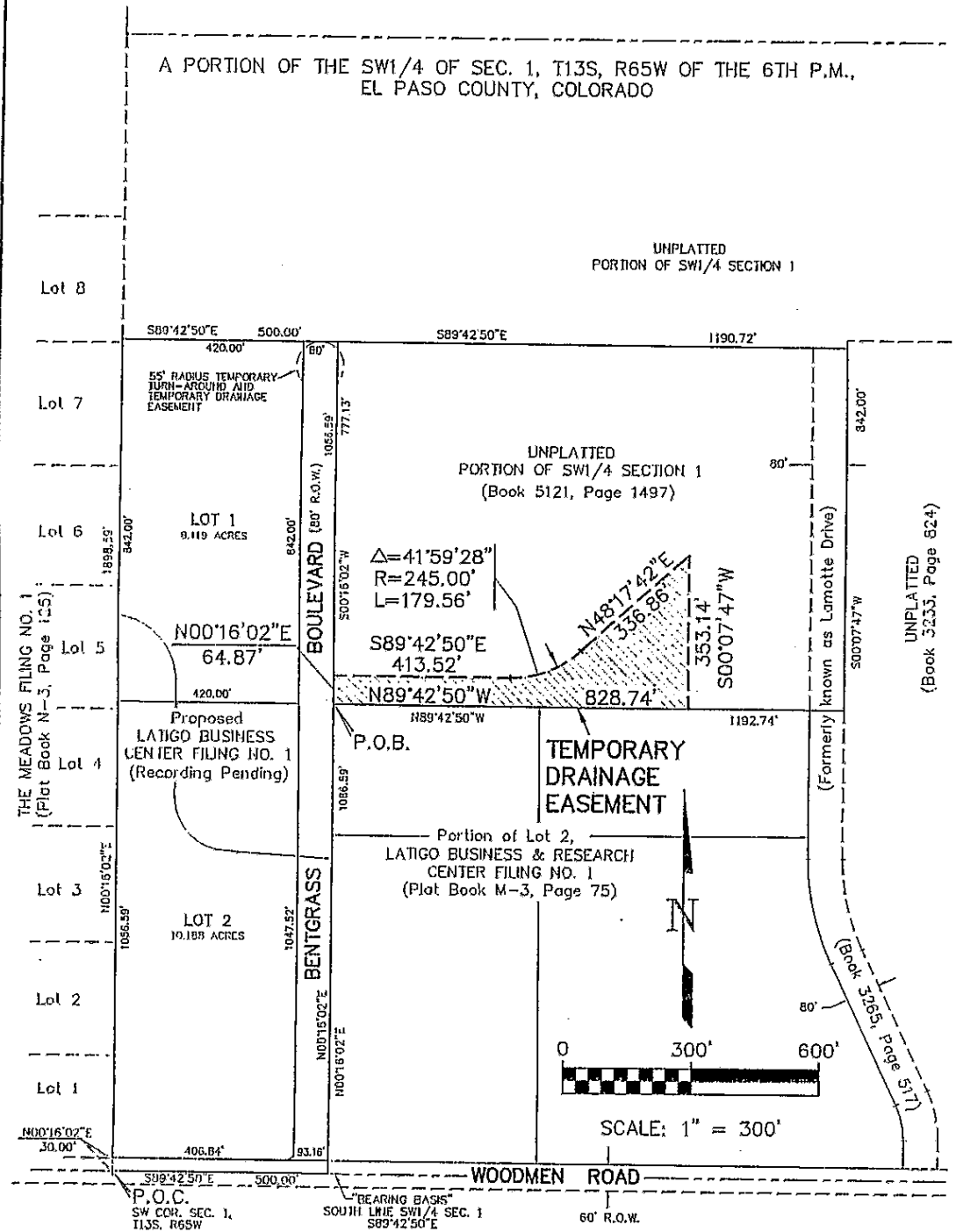

EXHIBIT "C"
SHEET 2 OF 2

LDC, Inc.
PLANNING, SURVEYING, LANDSCAPE ARCHITECTURE
3520 AUSTIN BLUFFS PARKWAY
COLORADO SPRINGS, CO. 80918
(719) 528-6133
FAX (719) 528-6848

NOTE:
This EXHIBIT does not represent a monumented land survey, and is only intended to depict the attached LEGAL DESCRIPTION.

REVISIONS			
NO.	DESCRIPTION	DATE	BY

DWN BY: RDG DATE: 12/16/04
CK'D BY: REF. NO.: 01081EXH2

PROJECT NUMBER
01081

F:\010001081 - ANDREWS\01081\exh2.dwg, Exhibit2, 12/20/2004 10:13:34 AM



LDC, Inc.

3520 AUSTIN BLUFFS PARKWAY
COLORADO SPRINGS, CO 80918
(719) 528-6133
FAX (719) 528-6848
www ldc-inc.com

LATIGO BUSINESS CENTER
Project No. 01081
December 17, 2004
Sheet 1 of 2

EXHIBIT "A"

LEGAL DESCRIPTION: A tract of land being a portion of the Southwest One-Quarter of Section 1, Township 13 South, Range 65 West of the 6th P.M., described by document (Book 5121, Page 1497, El Paso County, Colorado records), situate in El Paso County, Colorado.

EXHIBIT "B"

LEGAL DESCRIPTION: TEMPORARY DRAINAGE EASEMENT

A TEMPORARY DRAINAGE EASEMENT over and across a portion of the Southwest One-Quarter (SW1/4) of Section 1, Township 13 South, Range 65 West of the 6th P.M., also being a portion of that tract described by document (Book 5121, Page 1497, El Paso County, Colorado records), situate in El Paso County, Colorado, described as follows:

Commencing at the Southwest corner of said Section 1's SW1/4 (all bearings in this description are relative to the South line of said SW1/4, which bears S89°42'50"E "assumed"), said corner also being the Southwest corner of proposed LATIGO BUSINESS CENTER FILING NO. 1 (recording pending); thence S89°42'50"E along said SW1/4's South line, said line also being coincident with the Southerly line of said FILING, 500.00 feet to the Southeast corner of said FILING; thence N00°16'02"E along the Easterly line of said FILING, 1835.86 feet to the Point of Beginning of the EASEMENT herein described; thence continue N00°16'02"E along said FILING's Easterly line, 75.50 feet; thence Southeasterly on a non-tangent curve to the right, said curve having a central angle of 86°41'01", a radius of 55.00 feet, an arc length of 83.21 feet (the chord to said curve bears S00°16'02"W, a distance of 75.50 feet) to the Point of Beginning and the terminus point of this description.

SURVEYOR'S STATEMENT:

I, David V. Hostetler, a registered Professional Land Surveyor in the State of Colorado, do hereby state that the attached LEGAL DESCRIPTION and EXHIBIT were prepared under my direct responsibility, supervision, and checking, and on the basis of my knowledge, information and belief, are correct.

David V. Hostetler, Professional Land Surveyor
Colorado P.L.S. No. 20681
For and on behalf of LDC, Inc.

File: Docs/01081/Temp Drainage Easement 2.doc
DVH/dh

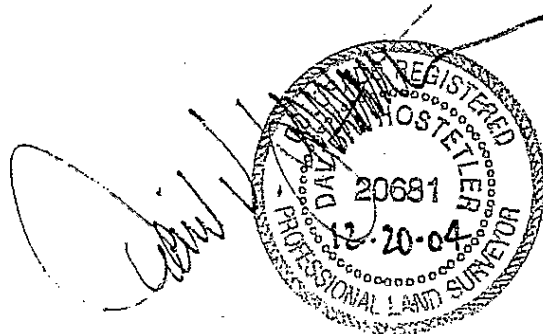

LEGAL DESCRIPTION EXHIBIT

A PORTION OF THE SW1/4 OF SEC. 1, T13S, R65W OF THE 6TH P.M., EL PASO COUNTY, COLORADO

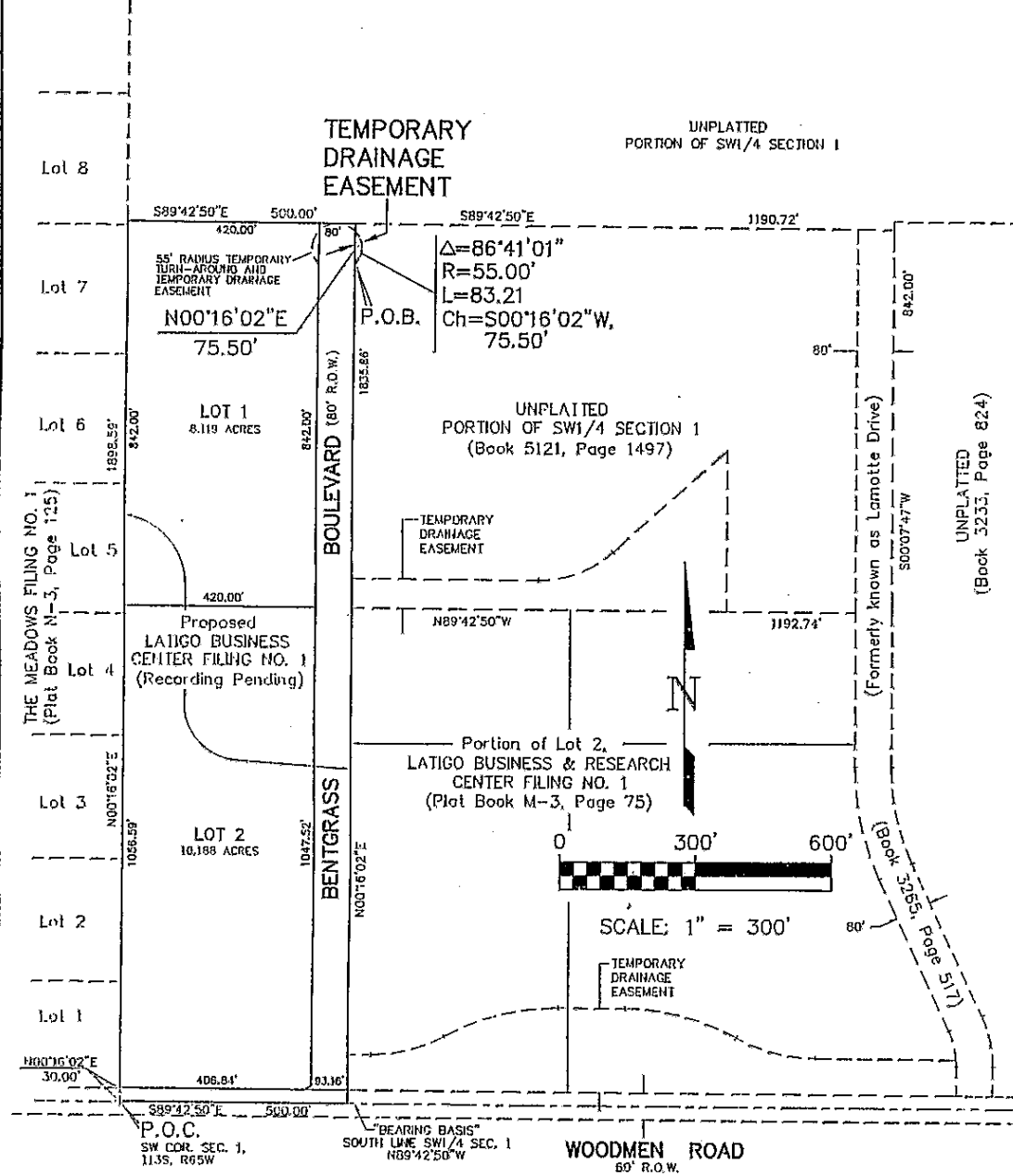

EXHIBIT "C"
SHEET 2 OF 2



LDC, Inc.

PLANNING, SURVEYING, LANDSCAPE ARCHITECTURE
3520 AUSTIN BLUFFS PARKWAY
COLORADO SPRINGS, CO. 80918
(719) 528-6133
FAX (719) 528-6848

NOTE:
This EXHIBIT does not represent a monumented land survey, and is only intended to depict the attached LEGAL DESCRIPTION.

REVISIONS

NO.	DESCRIPTION	DATE	BY

PROJECT NUMBER
01081

DWN BY: RDG	DATE: 12/20/04
CK'D BY:	REF. NO.: D1081exh2

EXHIBIT C

FINALLY APPROVED DEVELOPMENT DOCUMENTS:

These documents are incorporated herein by reference:

1. Latigo Business Center Filing No. 1, Construction Drawings, by Kiowa Engineering Corporation, originally dated October 9, 2003; including all revisions, as finally approved by the County.

2. Latigo Business Center Filing No. 1, Final Drainage Report and Erosion Control Plan, Originally dated October 7, 2003, by Kiowa Engineering Corporation; including all revisions, as finally approved by the County.

UNPLATTED
FALCON MEADOWS AT BENT GRASS
53010 00 019

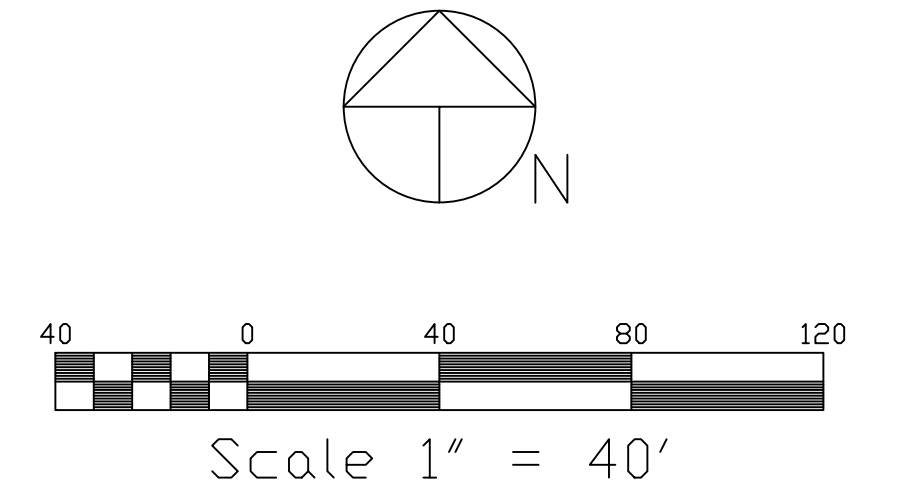

Contour Interval: 1
BENCH MARK: SE CORNER SECTION 1
1-1/2" AL. CAP. EL. 6901.70

LEGEND:

- ◁ FOUND RED LDC CAP ON #4 REBAR
- ⊙ SEWER MANHOLE (EXISTING)
- WATER MANHOLE (EXISTING)
- ⊗ WATER VALVE (EXISTING)
- ◇ FIRE HYDRANT (EXISTING)
- ✕ RV DUMP SITE (EXISTING)
- ⊠ ELECTRICAL VAULT (EXISTING)

GRADED AREAS NOT COVERED BY CONCRETE, ASPHALT OR LANDSCAPE SHALL BE RESEEDED (FINAL) SEE LANDSCAPE PLAN FOR DETAILS. NO BATCH PLANTS WILL BE UTILIZED ON THIS SITE. THERE ARE NO SURFACE WATERS ON THIS SITE.

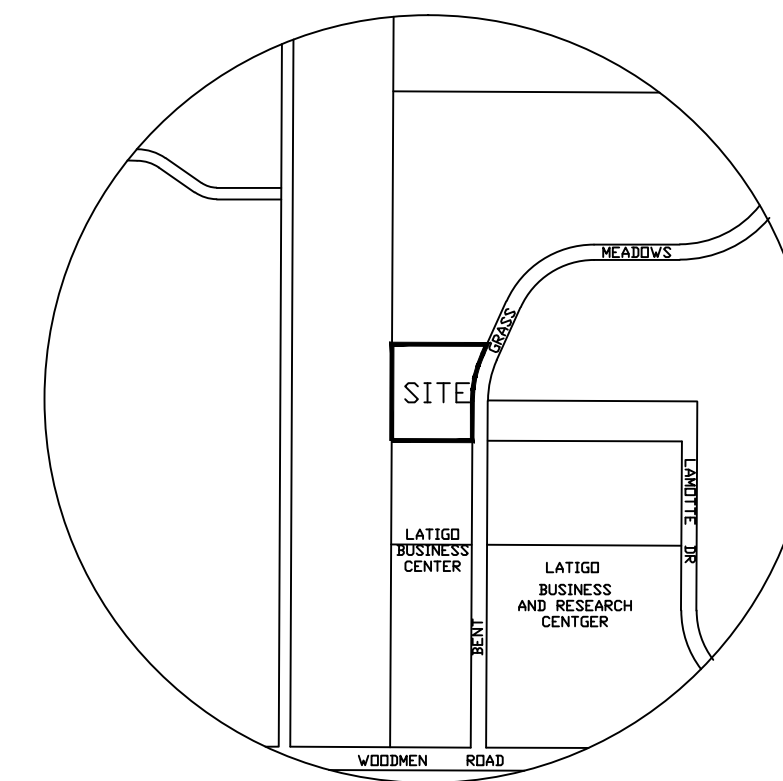

VICINITY MAP

1"=1000'

CONTOUR LEGEND:

- ORIGINAL CONTOURS:
 - 2' (dashed line)
 - 10' (dotted line)
- PROPOSED CONTOURS:
 - 2' (solid line)
 - 10' (solid line)

PROPOSED STORM SEWER AS LABELED

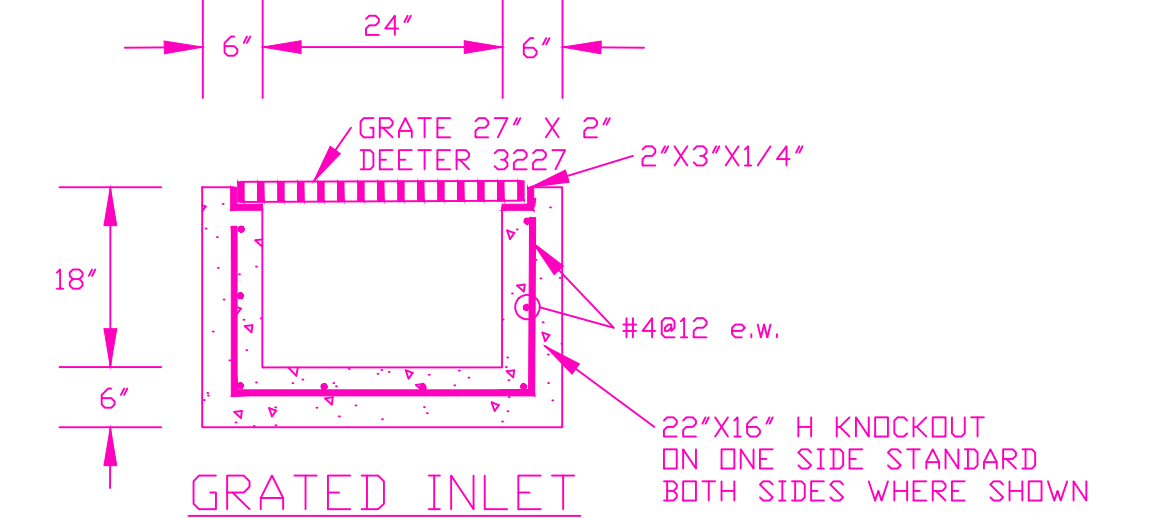

GRATED INLET

1/2"=1'-0"

INLETS SHALL CONFORM TO FIREBAUGH PRECAST CO. STD. INLET OR EQUAL

EROSION CONTROL LEGEND:

- SILT FENCE (SF) (INTERIM)
- VEHICLE TRACKING CONTROL (VTC) (INTERIM)
- STOCK PILE PROTECTION (SP) (INTERIM)
- LIMIT OF DISTURBANCE 4.860 AC, (INTERIM)
- EASEMENT LINE (FINAL)
- STABILIZED STAGING AREA (SSA) (INITIAL)
- DIRECTION OF RUNOFF (FINAL)
- PROPERTY BOUNDARY (FINAL)
- CONCRETE WASHOUT (CWD) (INTERIM)

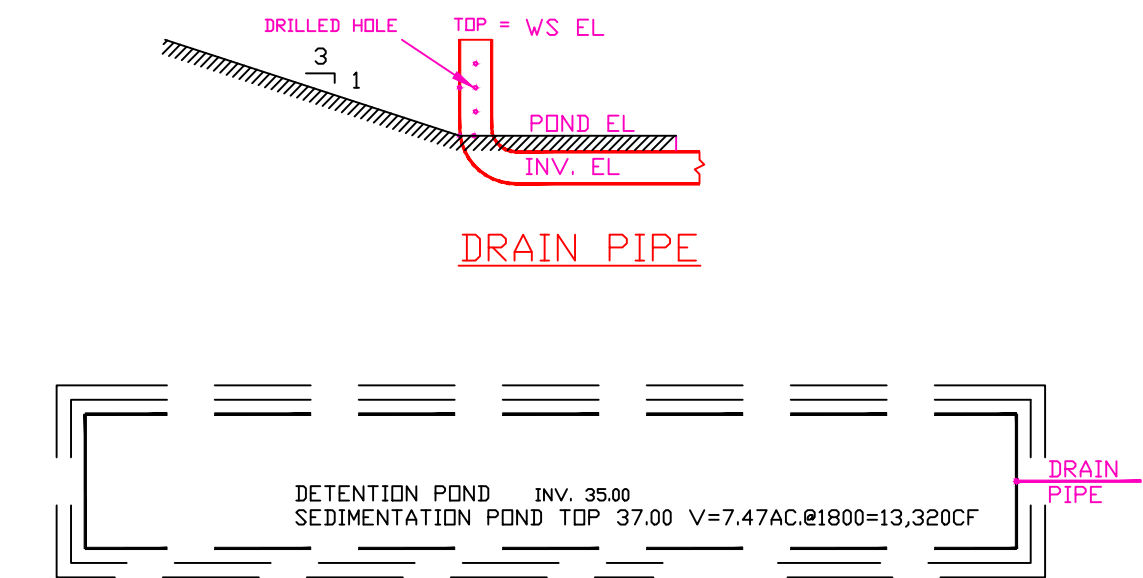

SEDIMENTATION BASINS

1"=40'
INTERIM CONDITION DURING CONSTRUCTION TO BE CONVERTED TO SAND FILTER BASIN

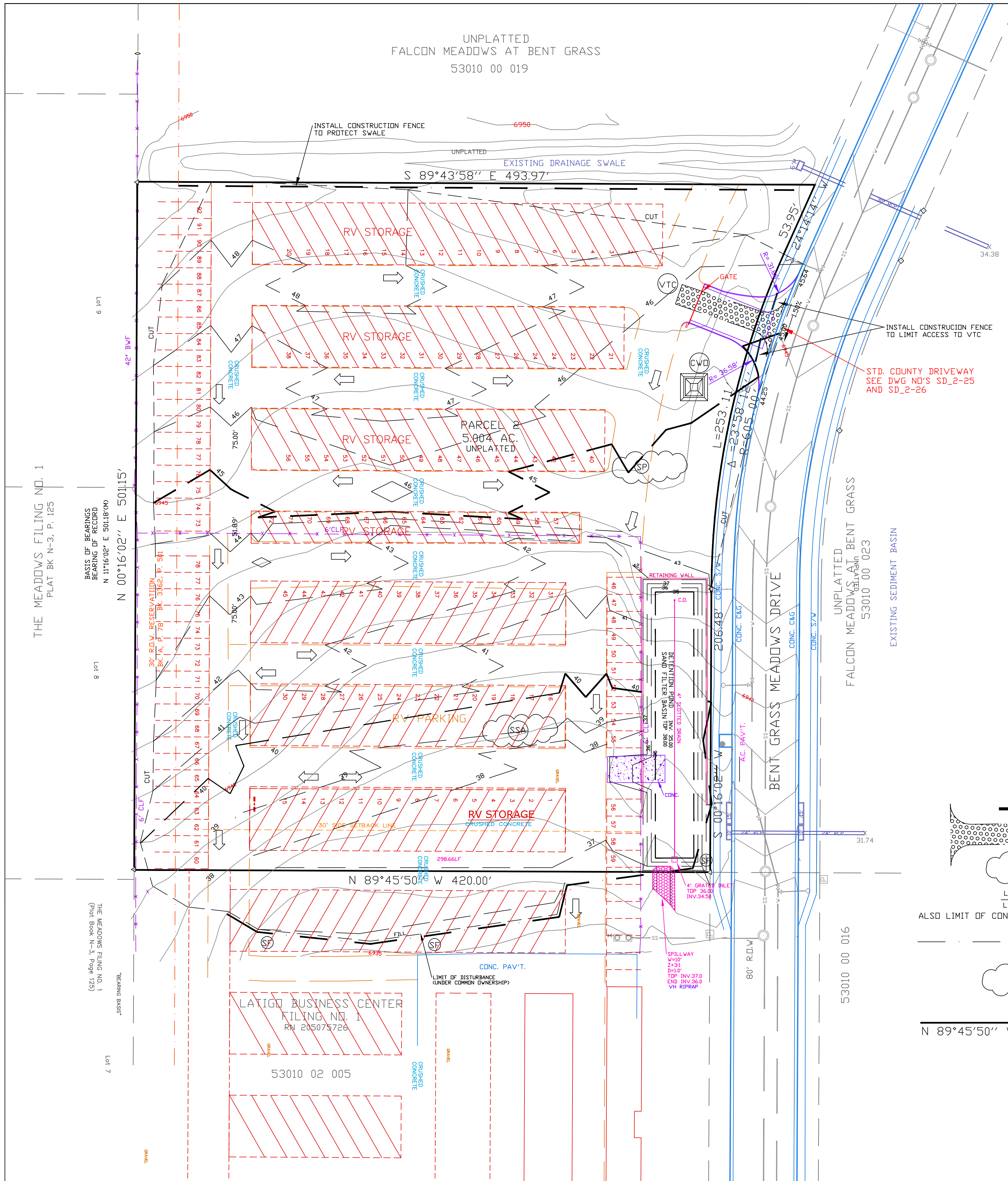

THE MEADOWS FILING NO. 1
PLAT BK N-3, P. 125

30' B.O.V. RESERVATION
BK N-3, P. 125
N 11°16'02" E 501.8' (0.00)

Lot 8

THE MEADOWS FILING NO. 1
(Plat Book N-3, Page 125)

Lot 7

OLIVER E. WATTS
CONSULTING ENGINEER
COLORADO SPRINGS

PROJECT
FALCON STORAGE PARCEL
PART W 1/2 SEC. 1, T.13S., R.65W., 6TH P.M.
EL PASO COUNTY

SHT. NAME
GRADING AND EROSION CONTROL PLAN

SHT. NO.
1
OF
4

DRAWN BY: D.E. WATTS	APPROVED BY:	REVISIONS
DATE: 1-29-21	PROJ. NO.:	
DWG. NO.: 20-5523-03	DWG.:	
SURVEYED BY: DEV, ESW, 10-6-20		

STANDARD NOTES FOR EL PASO COUNTY GRADING AND EROSION CONTROL PLANS

1. Stormwater discharges from construction sites shall not cause or threaten to cause pollution, contamination, or degradation of State Waters. All work and earth disturbance shall be done in a manner that minimizes pollution of any on-site or off-site waters, including wetlands.
2. Notwithstanding anything depicted in these plans in words or graphic representation, all design and construction related to roads, storm drainage and erosion control shall conform to the standards and requirements of the most recent version of the relevant adopted El Paso County standards, including the Land Development Code, the Engineering Criteria Manual, the Drainage Criteria Manual, and the Drainage Criteria Manual Volume 2. Any deviations from regulations and standards must be requested, and approved, in writing.
3. A separate Stormwater Management Plan (SMWP) for this project shall be completed and an Erosion and Stormwater Quality Control Permit (ESQCP) issued prior to commencing construction. Management of the SWMP during construction is the responsibility of the designated Qualified Stormwater Manager or Certified Erosion Control Inspector. The SWMP shall be located on site at all times during construction and shall be kept up to date with work progress and changes in the field.
4. Once the ESQCP is approved and a "Notice to Proceed" has been issued, the contractor may install the initial stage erosion and sediment control measures as indicated on the approved GEC. A Pre-construction Meeting between the contractor, engineer, and El Paso County will be held prior to any construction. It is the responsibility of the applicant to coordinate the meeting time and place with County staff.
5. Control measures must be installed prior to commencement of activities that could contribute pollutants to stormwater. Control measures for all slopes, channels, ditches, and disturbed land areas shall be installed immediately upon completion of the disturbance.
6. All temporary sediment and erosion control measures shall be maintained and remain in effective operating condition until permanent soil erosion control measures are implemented and final stabilization is established. All persons engaged in land disturbance activities shall assess the adequacy of control measures at the site and identify if changes to those control measures are needed to ensure the continued effective performance of the control measures. All changes to temporary sediment and erosion control measures must be incorporated into the Stormwater Management Plan.
7. Temporary stabilization shall be implemented on disturbed areas and stockpiles where ground disturbing construction activity has permanently ceased or temporarily ceased for longer than 14 days.
8. Final stabilization must be implemented at all applicable construction sites. Final stabilization is achieved when all ground disturbing activities are complete and all disturbed areas either have a uniform vegetative cover with individual plant density of 70 percent of pre-disturbance levels established or equivalent permanent alternative stabilization method is implemented. All temporary sediment and erosion control measures shall be removed upon final stabilization and before permit closure.
9. All permanent stormwater management facilities shall be installed as designed in the approved plans. Any proposed changes that effect the design or function of permanent stormwater management structures must be approved by the ECM Administrator prior to implementation.
10. Earth disturbances shall be conducted in such a manner so as to effectively minimize accelerated soil erosion and resulting sedimentation. All disturbances shall be designed, constructed, and completed so that the exposed area of any disturbed land shall be limited to the shortest practical period of time. Pre-existing vegetation shall be protected and maintained within 50 horizontal feet of waters of the state unless shown to be infeasible and specifically requested and approved.
11. Compaction of soil must be prevented in areas designated for infiltration control measures or where final stabilization will be achieved by vegetative cover. Areas designated for infiltration control measures shall also be protected from sedimentation during construction until final stabilization is achieved. If compaction prevention is not feasible due to site constraints, all areas designated for infiltration and vegetation control measures must be loosened prior to installation of the control measure(s).
12. Any temporary or permanent facility designed and constructed for the conveyance of stormwater around, through, or from the earth disturbance area shall be a stabilized conveyance designed to minimize erosion and the discharge of sediment off site.
13. Concrete wash water shall be contained and disposed of in accordance with the SWMP. No wash water shall be discharged to or allowed to enter State Waters, including any surface or subsurface storm drainage system or facilities. Concrete washouts shall not be located in an area where shallow groundwater may be present, or within 50 feet of a surface water body, creek or stream.
14. During dewatering operations of uncontaminated ground water may be discharged on site, but shall not leave the site in the form of surface runoff unless an approved State dewatering permit is in place.
15. Erosion control blanketing or other protective covering shall be used on slopes steeper than 3:1.
16. Contractor shall be responsible for the removal of all wastes from the construction site for disposal in accordance with local and State regulatory requirements. No construction debris, tree slash, building material wastes or unused building materials shall be buried, dumped, or discharged at the site.
17. Waste materials shall not be temporarily placed or stored in the street, alley, or other public way, unless in accordance with an approved Traffic Control Plan. Control measures may be required by El Paso County Engineering if deemed necessary, based on specific conditions and circumstances.
18. Tracking of soils and construction debris off-site shall be minimized. Materials tracked off-site shall be cleaned up and properly disposed of immediately.
19. The owner/developer shall be responsible for the removal of all construction debris, dirt, trash, rock, sediment, soil, and sand that may accumulate in roads, storm drains and other drainage conveyance systems and stormwater appurtenances as a result of site development.
20. The quantity of materials stored on the project site shall be limited, as much as practical, to that quantity required to perform the work in an orderly sequence. All materials stored on-site shall be stored in a neat, orderly manner, in their original containers, with original manufacturer's labels.
21. No chemical(s) having the potential to be released in stormwater are to be stored or used onsite unless permission for the use of such chemical(s) is granted in writing by the ECM Administrator. In granting approval for the use of such chemical(s), special conditions and monitoring may be required.
22. Bulk storage of allowed petroleum products or other allowed liquid chemicals in excess of 55 gallons shall require adequate secondary containment protection to contain all spills onsite and to prevent any spilled materials from entering State Waters, any surface or subsurface storm drainage system or other facilities.
23. No person shall cause the impediment of stormwater flow in the curb and gutter or ditch except with approved sediment control measures.
24. Owner/developer and their agents shall comply with the "Colorado Water Quality Control Act" (Title 25, Article 8, CRS), and the "Clean Water Act" (33 USC 1344), in addition to the requirements of the Land Development Code, DCM Volume II and the ECM Appendix I. All appropriate permits must be obtained by the contractor prior to construction (1041, NPDES, Floodplain, 404, fugitive dust, etc.). In the event of conflicts between these requirements and other laws, rules, or regulations of other Federal, State, local, or County agencies, the most restrictive laws, rules, or regulations shall apply.
25. All construction traffic must enter/exit the site only at approved construction access points.
26. Prior to construction the Permittee shall verify the location of existing utilities.
27. A water source shall be available on site during earthwork operations and shall be utilized as required to minimize dust from earthwork equipment and wind.
28. The soils report for this site has been prepared by Parr Engineering dated 11-20-13 and shall be considered a part of these plans.
29. At least ten (10) days prior to the anticipated start of construction, for projects that will disturb one (1) acre or more, the owner or operator of construction activity shall submit a permit application for stormwater discharge to the Colorado Department of Public Health and Environment, Water Quality Division. The application contains certification of completion of a stormwater management plan (SWMP), of which this Grading and Erosion Control Plan may be a part. For information or application materials contact:
Colorado Department of Public Health and Environment
Water Quality Control Division
WQCD - Permits
4300 Cherry Creek Drive South
Denver, CO 80246-1530
Attn: Permits Unit

Engineer's Statement (for GEC Plan within Construction Drawing set):

These detailed plans and specifications were prepared under my direction and supervision. Said plans and specifications have been prepared according to the criteria established by the County for detailed roadway, drainage, grading and erosion control plans and specifications, and said plans and specifications are in conformity with applicable master drainage plans and master transportation plans. Said plans and specifications meet the purposes for which the particular roadway and drainage facilities are designed and are correct to the best of my knowledge and belief. I accept responsibility for any liability caused by any negligent acts, errors or omissions on my part in preparation of these detailed plans and specifications.

 Engineer of Record Signature _____ Date _____
 Oliver E. Watts, COLO PELS#9853
 Oliver E. Watts Consulting Engineer, Inc.
 614 Elkton Drive Colorado Springs, CO 80907
 719-593-0173
 olliewatts@aol.com

Owner's Statement (for GEC Plan within Construction Drawing set):

I, the owner/developer have read and will comply with the requirements of the grading and erosion control plan and all of the requirements specified in these detailed plans and specifications.

 Richard Graham, Falcon Storage Partners, LLLP _____ date _____

El Paso County (standalone GEC Plan):

County plan review is provided only for general conformance with County Design Criteria. The County is not responsible for the accuracy and adequacy of the design, dimensions, and/or elevations which shall be confirmed at the job site. The County through the approval of this document assumes no responsibility for completeness and/or accuracy of this document. Filed in accordance with the requirements of the El Paso County Land Development Code, Drainage Criteria Manual Volumes 1 and 2, and Engineering Criteria Manual, as amended.

In accordance with ECM Section 1.12, these construction documents will be valid for construction for a period of 2 years from the date signed by the El Paso County Engineer. If construction has not started within those 2 years, the plans will need to be resubmitted for approval, including payment of review fees at the Planning and Community Development Director's discretion.

 _____, PE County Engineer / ECM Administrator _____ date _____

DRAWN BY: O.E. WATTS DATE: 1-29-21 DWG. NO.: 20-5523-05 SURVEYED BY: DEV, ESW, 10-6-20	APPROVED BY: PROJ. NO. DWG.	REVISIONS	PROJECT OLIVER E. WATTS CONSULTING ENGINEER COLORADO SPRINGS FALCON STORAGE PARCEL PART W 1/2 SEC. 1, T.13S., R.65W., 6TH P.M. EL PASO COUNTY	SHEET NO. GRADING AND EROSION CONTROL PLAN 2 OF 4	SHEET NO.
---	-----------------------------------	-----------	---	---	-----------

Silt Fence (SF) SC-1

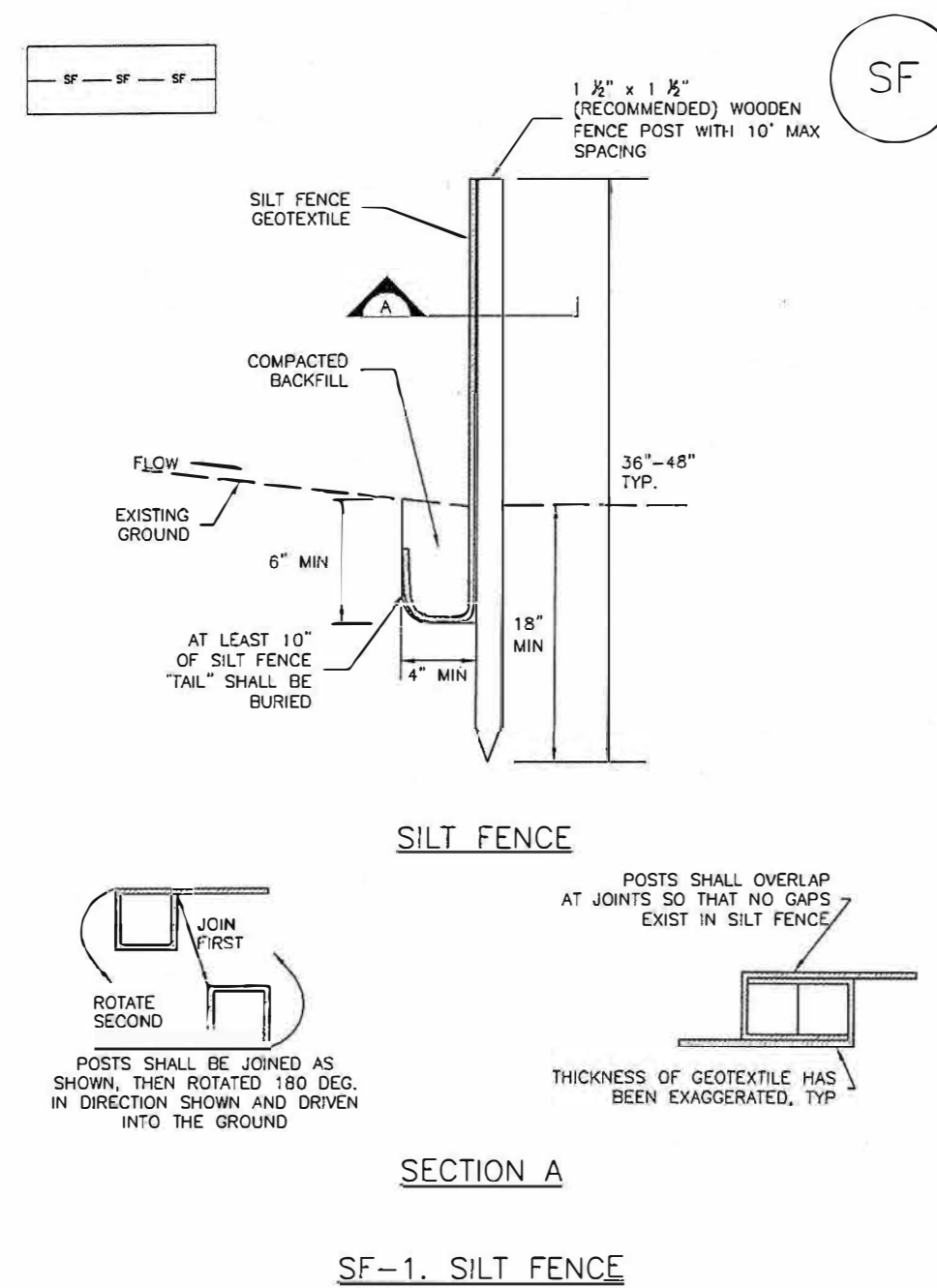

November 2010 Urban Drainage and Flood Control District Urban Storm Drainage Criteria Manual Volume 3 SF-3

Stockpile Management (SP) MM-2

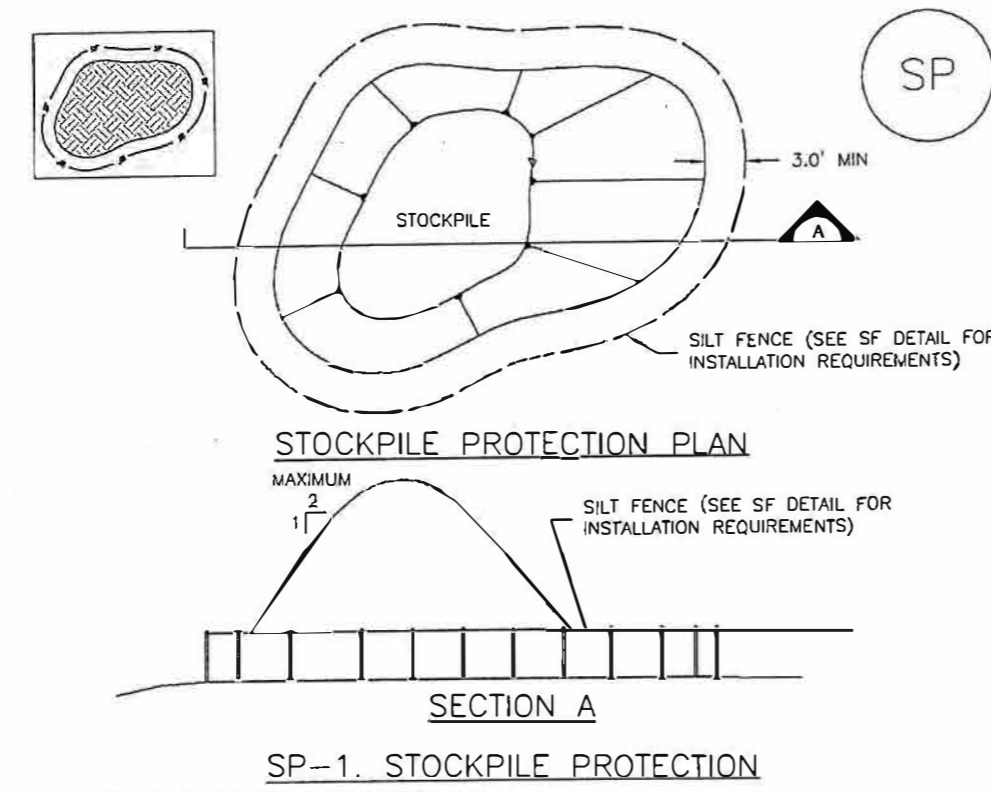

STOCKPILE PROTECTION INSTALLATION NOTES

- SEE PLAN VIEW FOR:
 - LOCATION OF STOCKPILE
 - TYPE OF STOCKPILE PROTECTION
- INSTALL PERIMETER CONTROLS IN ACCORDANCE WITH THEIR RESPECTIVE DESIGN DETAILS. SILT FENCE IS SHOWN IN THE STOCKPILE PROTECTION DETAILS; HOWEVER, OTHER TYPES OF PERIMETER CONTROLS INCLUDING SEDIMENT CONTROL LOGS OR ROCK SOCKS MAY BE SUITABLE IN SOME CIRCUMSTANCES. CONSIDERATIONS FOR DETERMINING THE APPROPRIATE TYPE OF PERIMETER CONTROL FOR A STOCKPILE INCLUDE WHETHER THE STOCKPILE IS LOCATED ON A PERVIOUS OR IMPERVIOUS SURFACE, THE RELATIVE HEIGHTS OF THE PERIMETER CONTROL AND STOCKPILE, THE ABILITY OF THE PERIMETER CONTROL TO CONTAIN THE STOCKPILE WITHOUT FAILING IN THE EVENT THAT MATERIAL FROM THE STOCKPILE SHIFTS OR SLUMPS AGAINST THE PERIMETER, AND OTHER FACTORS.
- STABILIZE THE STOCKPILE SURFACE WITH SURFACE ROUGHENING, TEMPORARY SEEDING AND MULCHING, EROSION CONTROL BLANKETS, OR SOIL BINDERS. SOILS STOCKPILED FOR AN EXTENDED PERIOD (TYPICALLY FOR MORE THAN 60 DAYS) SHOULD BE SEEDED AND MULCHED WITH A TEMPORARY GRASS COVER ONCE THE STOCKPILE IS PLACED (TYPICALLY WITHIN 14 DAYS). USE OF MULCH ONLY OR A SOIL ENHANCER IS ACCEPTABLE IF THE STOCKPILE WILL BE IN PLACE FOR A MORE LIMITED TIME PERIOD (TYPICALLY 30-60 DAYS).
- FOR TEMPORARY STOCKPILES ON THE INTERIOR PORTION OF A CONSTRUCTION SITE, WHERE OTHER DOWN-DRAINAGE CONTROLS, INCLUDING PERIMETER CONTROL, ARE IN PLACE, STOCKPILE PERIMETER CONTROLS MAY NOT BE REQUIRED.

November 2010 Urban Drainage and Flood Control District Urban Storm Drainage Criteria Manual Volume 3 SP-3

Stabilized Staging Area (SSA) SM-6

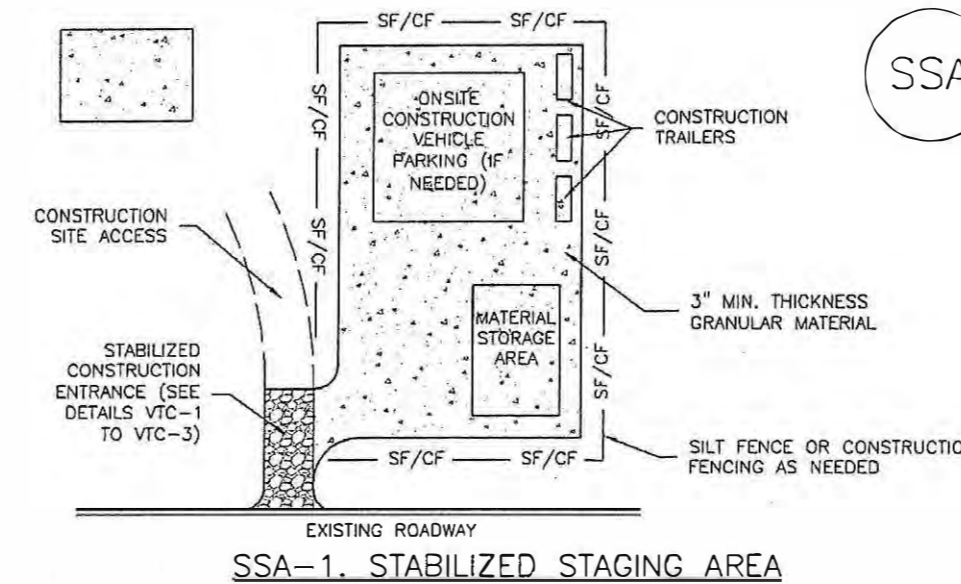

STABILIZED STAGING AREA INSTALLATION NOTES

- SEE PLAN VIEW FOR:
 - LOCATION OF STAGING AREA(S)
 - CONTRACTOR MAY ADJUST LOCATION AND SIZE OF STAGING AREA WITH APPROVAL FROM THE LOCAL JURISDICTION.
- STABILIZED STAGING AREA SHOULD BE APPROPRIATE FOR THE NEEDS OF THE SITE. OVERSIZING RESULTS IN A LARGER AREA TO STABILIZE FOLLOWING CONSTRUCTION.
- STAGING AREA SHALL BE STABILIZED PRIOR TO OTHER OPERATIONS ON THE SITE.
- THE STABILIZED STAGING AREA SHALL CONSIST OF A MINIMUM 3" THICK GRANULAR MATERIAL.
- UNLESS OTHERWISE SPECIFIED BY LOCAL JURISDICTION, ROCK SHALL CONSIST OF DOT SECT. #703, AASHTO #3 COARSE AGGREGATE OR 8" (MINUS) ROCK.
- ADDITIONAL PERIMETER BMPs MAY BE REQUIRED INCLUDING BUT NOT LIMITED TO SILT FENCE AND CONSTRUCTION FENCING.

STABILIZED STAGING AREA MAINTENANCE NOTES

- INSPECT BMPs EACH WORKDAY, AND MAINTAIN THEM IN EFFECTIVE OPERATING CONDITION. MAINTENANCE OF BMPs SHOULD BE PROACTIVE, NOT REACTIVE. INSPECT BMPs AS SOON AS POSSIBLE (AND ALWAYS WITHIN 24 HOURS) FOLLOWING A STORM THAT CAUSES SURFACE EROSION, AND PERFORM NECESSARY MAINTENANCE.
- FREQUENT OBSERVATIONS AND MAINTENANCE ARE NECESSARY TO MAINTAIN BMPs IN EFFECTIVE OPERATING CONDITION. INSPECTIONS AND CORRECTIVE MEASURES SHOULD BE DOCUMENTED THOROUGHLY.
- WHERE BMPs HAVE FAILED, REPAIR OR REPLACEMENT SHOULD BE INITIATED UPON DISCOVERY OF THE FAILURE.
- ROCK SHALL BE REAPPLIED OR REGRADED AS NECESSARY IF RUTTING OCCURS OR UNDERLYING SUBGRADE BECOMES EXPOSED.

November 2010 Urban Drainage and Flood Control District Urban Storm Drainage Criteria Manual Volume 3 SSA-3

SC-1 Silt Fence (SF)

SILT FENCE INSTALLATION NOTES

- SILT FENCE MUST BE PLACED AWAY FROM THE TOE OF THE SLOPE TO ALLOW FOR WATER PONDING. SILT FENCE AT THE TOE OF A SLOPE SHOULD BE INSTALLED IN A FLAT LOCATION AT LEAST SEVERAL FEET (2-3 FT) FROM THE TOE OF THE SLOPE TO ALLOW ROOM FOR PONDING AND DEPOSITION.
- A UNIFORM 6" X 4" ANCHOR TRENCH SHALL BE EXCAVATED USING TRENCHER OR SILT FENCE INSTALLATION DEVICE. NO ROAD GRADERS, BACKHOES, OR SIMILAR EQUIPMENT SHALL BE USED.
- COMPACT ANCHOR TRENCH BY HAND WITH A "JUMPING JACK" OR BY WHEEL ROLLING. COMPACTION SHALL BE SUCH THAT SILT FENCE RESISTS BEING PULLED OUT OF ANCHOR TRENCH BY HAND.
- SILT FENCE SHALL BE PULLED TIGHT AS IT IS ANCHORED TO THE STAKES. THERE SHOULD BE NO NOTICEABLE SHO BETWEEN STAKES AFTER IT HAS BEEN ANCHORED TO THE STAKES.
- SILT FENCE FABRIC SHALL BE ANCHORED TO THE STAKES USING 1" HEAVY DUTY STAPLES OR NAILS WITH 1" HEADS. STAPLES AND NAILS SHOULD BE PLACED 3" ALONG THE FABRIC DOWN THE STAKE.
- AT THE END OF A RUN OF SILT FENCE ALONG A CONTOUR, THE SILT FENCE SHOULD BE TURNED PERPENDICULAR TO THE CONTOUR TO CREATE A "U-HOOK." THE "U-HOOK" EXTENDING PERPENDICULAR TO THE CONTOUR SHOULD BE OF SUFFICIENT LENGTH TO KEEP RUNOFF FROM FLOWING AROUND THE END OF THE SILT FENCE (TYPICALLY 10' - 20').
- SILT FENCE SHALL BE INSTALLED PRIOR TO ANY LAND DISTURBING ACTIVITIES.

SILT FENCE MAINTENANCE NOTES

- INSPECT BMPs EACH WORKDAY, AND MAINTAIN THEM IN EFFECTIVE OPERATING CONDITION. MAINTENANCE OF BMPs SHOULD BE PROACTIVE, NOT REACTIVE. INSPECT BMPs AS SOON AS POSSIBLE (AND ALWAYS WITHIN 24 HOURS) FOLLOWING A STORM THAT CAUSES SURFACE EROSION, AND PERFORM NECESSARY MAINTENANCE.
- FREQUENT OBSERVATIONS AND MAINTENANCE ARE NECESSARY TO MAINTAIN BMPs IN EFFECTIVE OPERATING CONDITION. INSPECTIONS AND CORRECTIVE MEASURES SHOULD BE DOCUMENTED THOROUGHLY.
- WHERE BMPs HAVE FAILED, REPAIR OR REPLACEMENT SHOULD BE INITIATED UPON DISCOVERY OF THE FAILURE.
- SEDIMENT ACCUMULATED UPSTREAM OF THE SILT FENCE SHALL BE REMOVED AS NEEDED TO MAINTAIN THE FUNCTIONALITY OF THE BMP. TYPICALLY WHEN DEPTH OF ACCUMULATED SEDIMENTS IS APPROXIMATELY 8".
- REPAIR OR REPLACE SILT FENCE WHEN THERE ARE SIGNS OF WEAR, SUCH AS SAGGING, TEARING, OR COLLAPSE.
- SILT FENCE IS TO REMAIN IN PLACE UNTIL THE UPSTREAM DISTURBED AREA IS STABILIZED AND APPROVED BY THE LOCAL JURISDICTION, OR IS REPLACED BY AN EQUIVALENT PERIMETER SEDIMENT CONTROL BMP.
- WHEN SILT FENCE IS REMOVED, ALL DISTURBED AREAS SHALL BE COVERED WITH TOPSOIL, SEEDED AND MULCHED OR OTHERWISE STABILIZED AS APPROVED BY LOCAL JURISDICTION.

(DETAILS ADAPTED FROM TORONTO, COLORADO AND CITY OF AURORA, NOT AVAILABLE IN AUTOCAD)

NOTE: MANY JURISDICTIONS HAVE BMP DETAILS THAT VARY FROM UDFCD STANDARD DETAILS. CONSULT WITH LOCAL JURISDICTIONS AS TO WHICH DETAIL SHOULD BE USED WHEN DIFFERENCES ARE NOTED.

SF-4 Urban Drainage and Flood Control District Urban Storm Drainage Criteria Manual Volume 3 November 2010

MM-2 Stockpile Management (SM)

STOCKPILE PROTECTION MAINTENANCE NOTES

- INSPECT BMPs EACH WORKDAY, AND MAINTAIN THEM IN EFFECTIVE OPERATING CONDITION. MAINTENANCE OF BMPs SHOULD BE PROACTIVE, NOT REACTIVE. INSPECT BMPs AS SOON AS POSSIBLE (AND ALWAYS WITHIN 24 HOURS) FOLLOWING A STORM THAT CAUSES SURFACE EROSION, AND PERFORM NECESSARY MAINTENANCE.
- FREQUENT OBSERVATIONS AND MAINTENANCE ARE NECESSARY TO MAINTAIN BMPs IN EFFECTIVE OPERATING CONDITION. INSPECTIONS AND CORRECTIVE MEASURES SHOULD BE DOCUMENTED THOROUGHLY.
- WHERE BMPs HAVE FAILED, REPAIR OR REPLACEMENT SHOULD BE INITIATED UPON DISCOVERY OF THE FAILURE.

STOCKPILE PROTECTION MAINTENANCE NOTES

- IF PERIMETER PROTECTION MUST BE MOVED TO ACCESS SOIL STOCKPILE, REPLACE PERIMETER CONTROLS BY THE END OF THE WORKDAY.
- STOCKPILE PERIMETER CONTROLS CAN BE REMOVED ONCE ALL THE MATERIAL FROM THE STOCKPILE HAS BEEN USED.

(DETAILS ADAPTED FROM DENVER, COLORADO, NOT AVAILABLE IN AUTOCAD)

NOTE: MANY JURISDICTIONS HAVE BMP DETAILS THAT VARY FROM UDFCD STANDARD DETAILS. CONSULT WITH LOCAL JURISDICTIONS AS TO WHICH DETAIL SHOULD BE USED WHEN DIFFERENCES ARE NOTED.

SP-4 Urban Drainage and Flood Control District Urban Storm Drainage Criteria Manual Volume 3 November 2010

SM-6 Stabilized Staging Area (SSA)

STABILIZED STAGING AREA MAINTENANCE NOTES

- STABILIZED STAGING AREA SHALL BE ENLARGED IF NECESSARY TO CONTAIN PARKING, STORAGE, AND UNLOADING/LOADING OPERATIONS.
- THE STABILIZED STAGING AREA SHALL BE REMOVED AT THE END OF CONSTRUCTION. THE GRANULAR MATERIAL SHALL BE REMOVED OR, IF APPROVED BY THE LOCAL JURISDICTION, USED ON SITE, AND THE AREA COVERED WITH TOPSOIL, SEEDS AND MULCHED OR OTHERWISE STABILIZED IN A MANNER APPROVED BY LOCAL JURISDICTION.

NOTE: MANY MUNICIPALITIES PROHIBIT THE USE OF RECYCLED CONCRETE AS GRANULAR MATERIAL FOR STABILIZED STAGING AREAS DUE TO DIFFICULTIES WITH RE-ESTABLISHMENT OF VEGETATION IN AREAS WHERE RECYCLED CONCRETE WAS PLACED.

NOTE: MANY JURISDICTIONS HAVE BMP DETAILS THAT VARY FROM UDFCD STANDARD DETAILS. CONSULT WITH LOCAL JURISDICTIONS AS TO WHICH DETAIL SHOULD BE USED WHEN DIFFERENCES ARE NOTED.

(DETAILS ADAPTED FROM DOUGLAS COUNTY, COLORADO, NOT AVAILABLE IN AUTOCAD)

SSA-4 Urban Drainage and Flood Control District Urban Storm Drainage Criteria Manual Volume 3 November 2010

Prepared by the Office of:
Oliver E. Watts, Consulting Engineer, Inc.
614 Elkton Drive, Colorado Springs, CO 80907
719-593-0173
oliewatts@aol.com
Celebrating over 39 years in business

DRAWN BY: O.E. WATTS	APPROVED BY:	REVISIONS	PROJECT	SHT. NAME	SHT. NO.
DATE: 12-14-18	PROJ. NO.		OLIVER E. WATTS CONSULTING ENGINEER COLORADO SPRINGS	EROSION CONTROL DETAILS	3
DWG. NO.: 20-5523	DWG.				OF 4

SEEDING & MULCHING

ALL SOIL TESTING, SOILS AMENDMENT AND FERTILIZER DOCUMENTATION, AND SEED LOAD AND BAG TICKETS MUST BE ADDED TO THE CSWMP.

SOIL PREPARATION

1. IN AREAS TO BE SEEDDED, THE UPPER 6 INCHES OF THE SOIL MUST NOT BE HEAVILY COMPACTED, AND SHOULD BE IN FRABLE CONDITION. LESS THAN 85% STANDARD PROCTOR DENSITY IS ACCEPTABLE. AREAS OF COMPACTION OR GENERAL CONSTRUCTION ACTIVITY MUST BE SCARIFIED TO A DEPTH OF 4 TO 15 INCHES PRIOR TO SPREADING TOPSOIL TO BREAK UP COMPACTED LAYERS AND PROVIDE A BLENDING ZONE BETWEEN DIFFERENT SOIL LAYERS.
2. AREAS TO BE PLANTED SHALL HAVE AT LEAST 4 INCHES OF TOPSOIL SUITABLE TO SUPPORT PLANT GROWTH.
3. THE CITY RECOMMENDS THAT EXISTING AND/OR IMPORTED TOPSOIL BE TESTED TO IDENTIFY SOIL DEFICIENCIES AND ANY SOIL AMENDMENTS NECESSARY TO ADDRESS THESE DEFICIENCIES. SOIL AMENDMENTS AND/OR FERTILIZERS SHOULD BE ADDED TO CORRECT TOPSOIL DEFICIENCIES BASED ON SOIL TESTING RESULTS.
4. TOPSOIL SHALL BE PROTECTED DURING THE CONSTRUCTION PERIOD TO RETAIN ITS STRUCTURE AVOID COMPACTION, AND TO PREVENT EROSION AND CONTAMINATION. STRIPPED TOPSOIL MUST BE STORED IN AN AREA AWAY FROM MACHINERY AND CONSTRUCTION OPERATIONS, AND CARE MUST BE TAKEN TO PROTECT THE TOPSOIL AS A VALUABLE COMMODITY. TOPSOIL MUST NOT BE STRIPPED DURING UNDESIRABLE WORKING CONDITIONS (E.G. DURING WET WEATHER OR WHEN SOILS ARE SATURATED). TOPSOIL SHALL NOT BE STORED IN SWALES OR IN AREAS WITH POOR DRAINAGE.

SEEDING

1. ALLOWABLE SEED MIXES ARE INCLUDED IN THE CITY OF COLORADO SPRINGS STORMWATER CONSTRUCTION MANUAL. ALTERNATIVE SEED MIXES ARE ACCEPTABLE IF INCLUDED IN AN APPROVED LANDSCAPING PLAN.
2. SEED SHOULD BE DRILL-SEED WHENEVER POSSIBLE.
3. SEED DEPTH MUST BE 3/4 TO 3/8 INCHES WHEN DRILL-SEEDING IS USED.
4. BROADCAST SEEDING OR HYDRO-SEEDING WITH TACKIFIER MAY BE SUBSTITUTED ON SLOPES STEEPER THAN 3:1 OR ON OTHER AREAS NOT PRACTICAL TO DRILL SEED.
5. SEEDING RATES MUST BE DOUBLED FOR BROADCAST SEEDING OR INCREASED BY 50% IF USING A BRILLIANT DRILL OR HYDRO-SEEDING.
6. BROADCAST SEEDING MUST BE LIGHTLY HAND-RAKED INTO THE SOIL.

MULCHING

1. MULCHING SHOULD BE COMPLETED AS SOON AS PRACTICABLE AFTER SEEDING, HOWEVER PLANTED AREAS MUST BE MULCHED NO LATER THAN 14 DAYS AFTER PLANTING.
2. MULCHING REQUIREMENTS INCLUDE:
 - HAY OR STRAW MULCH
 - ONLY CERTIFIED WEED-FREE AND CERTIFIED SEED-FREE MULCH MAY BE USED. MULCH MUST BE APPLIED AT 2 TONS/ACRE AND ADEQUATELY SECURED BY CRIMPING AND/OR TACKIFIER.
 - CRIMPING MUST NOT BE USED ON SLOPES GREATER THAN 3:1 AND MULCH FIBERS MUST BE TUCKED INTO THE SOIL TO A DEPTH OF 3 TO 4 INCHES.
 - TACKIFIER MUST BE USED IN PLACE OF CRIMPING ON SLOPES STEEPER THAN 3:1.
 - HYDRAULIC MULCHING
 - HYDRAULIC MULCHING IS AN OPTION ON STEEP SLOPES OR WHERE ACCESS IS LIMITED.
 - IF HYDRO-SEEDING IS USED, MULCHING MUST BE APPLIED AS A SEPARATE, SECOND OPERATION.
 - WOOD CELLULOSE FIBERS MIXED WITH WATER MUST BE APPLIED AT A RATE OF 1,000 TO 2,000 POUNDS/ACRE, AND TACKIFIER MUST BE APPLIED AT A RATE OF 100 POUNDS/ACRE.
 - EROSION CONTROL BLANKET
 - EROSION CONTROL BLANKET MAY BE USED IN PLACE OF TRADITIONAL MULCHING METHODS.



	SEEDING & MULCHING
	APPROVED: DATE: 10/7/19 BY: [Name]

Concrete Washout Area (CWA) MM-1

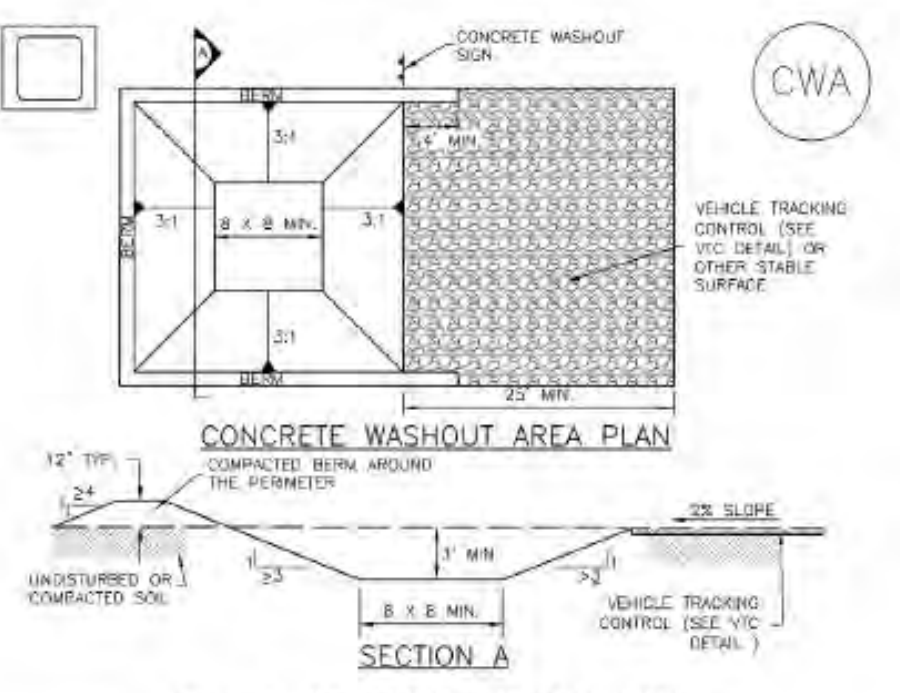

CWA-1. CONCRETE WASHOUT AREA

- CWA INSTALLATION NOTES**
1. SEE PLAN VIEW FOR:
 - CWA INSTALLATION LOCATION
 2. DO NOT LOCATE AN UNLINED CWA WITHIN 400' OF ANY NATURAL DRAINAGE PATHWAY OR WATERBODY. DO NOT LOCATE WITHIN 1,000' OF ANY WELLS OR DRINKING WATER SOURCES. IF SITE CONSTRAINTS MAKE THIS IMPOSSIBLE, OR IF HIGHLY PERMEABLE SOILS EXIST ON SITE, THE CWA MUST BE INSTALLED WITH AN IMPERMEABLE LINER (1/8 MIN. THICKNESS) OF SURFACE STORAGE ALTERNATIVELY USING PRECAST/CAST CONCRETE WASHOUT DEVICES OR A LINED ABOVE GROUND STORAGE ARE SHOULD BE USED.
 3. THE CWA SHALL BE INSTALLED PRIOR TO CONCRETE PLACEMENT OR SET.
 4. CWA SHALL INCLUDE A FLAT SURFACE PIT THAT IS AT LEAST 8' BY 8' SLOPES LEADING OUT OF THE SURFACE PIT SHALL BE 3:1 OR FLATTER. THE PIT SHALL BE AT LEAST 3' DEEP.
 5. RETAIN SURROUNDING SIDES AND BACK OF THE CWA SHALL HAVE MINIMUM HEIGHT OF 1'.
 6. VEHICLE TRACKING PAD SHALL BE SLOPED 2% TOWARDS THE CWA.
 7. STONES SHALL BE PLACED AT THE CONSTRUCTION ENTRANCE AT THE CWA, AND BLANKETS, AS NECESSARY TO CLEARLY MARK THE LOCATION OF THE CWA TO OPERATORS OF CONCRETE TRUCKS AND PUMP TRUCKS.
 8. USE EXCAVATED MATERIAL FOR PERMANENT BERM CONSTRUCTION.

MM-1 Concrete Washout Area (CWA)

- CWA MAINTENANCE NOTES**
1. INSPECT BUFFS EACH WORKDAY, AND MAINTAIN THEM IN EFFECTIVE OPERATING CONDITION. MAINTENANCE OF BUFFS SHOULD BE PROACTIVE, NOT REACTIVE. INSPECT BUFFS AS SOON AS POSSIBLE (AND ALWAYS WITHIN 24 HOURS) FOLLOWING A STORM THAT CAUSES SURFACE EROSION, AND PERFORM NECESSARY MAINTENANCE.
 2. FREQUENT OBSERVATIONS AND MAINTENANCE ARE NECESSARY TO MAINTAIN BUFFS IN EFFECTIVE OPERATING CONDITION. INSPECTIONS AND CORRECTIVE MEASURES SHOULD BE DOCUMENTED THOROUGHLY.
 3. WHERE BUFFS HAVE FAILED, REPAIR OR REPLACEMENT SHOULD BE INITIATED UPON OCCURRENCE OF THE FAILURE.
 4. THE CWA SHALL BE REPAIRED, CLEANED, OR ENLARGED AS NECESSARY TO MAINTAIN CAPACITY FOR CONCRETE WASTE. CONCRETE WASTE ACCUMULATED IN THE PIT SHALL BE REMOVED ONCE THE MATERIALS HAVE REACHED A DEPTH OF 2'.
 5. CONCRETE WASHOUT WATER, WASTED PIECES OF CONCRETE AND ALL OTHER DEBRIS IN THE SURFACE PIT SHALL BE TRANSPORTED FROM THE JOB SITE IN A WASTEWATER CONTAINER AND DISPOSED OF PROPERLY.
 6. THE CWA SHALL REMAIN IN PLACE UNTIL ALL CONCRETE FOR THE PROJECT IS PLACED.
 7. WHEN THE CWA IS REMOVED, COVER THE DISTURBED AREA WITH TOP SOIL, SEED AND MULCH OR OTHERWISE STABILIZED IN A MANNER APPROVED BY THE LOCAL JURISDICTION.
- NOTE: MANY JURISDICTIONS HAVE DIFFERENT DETAILS THAT VARY FROM IUCED STANDARD DETAILS. CONSULT WITH LOCAL JURISDICTIONS AS TO WHICH DETAIL SHOULD BE USED WHEN DIFFERENCES ARE NOTED.

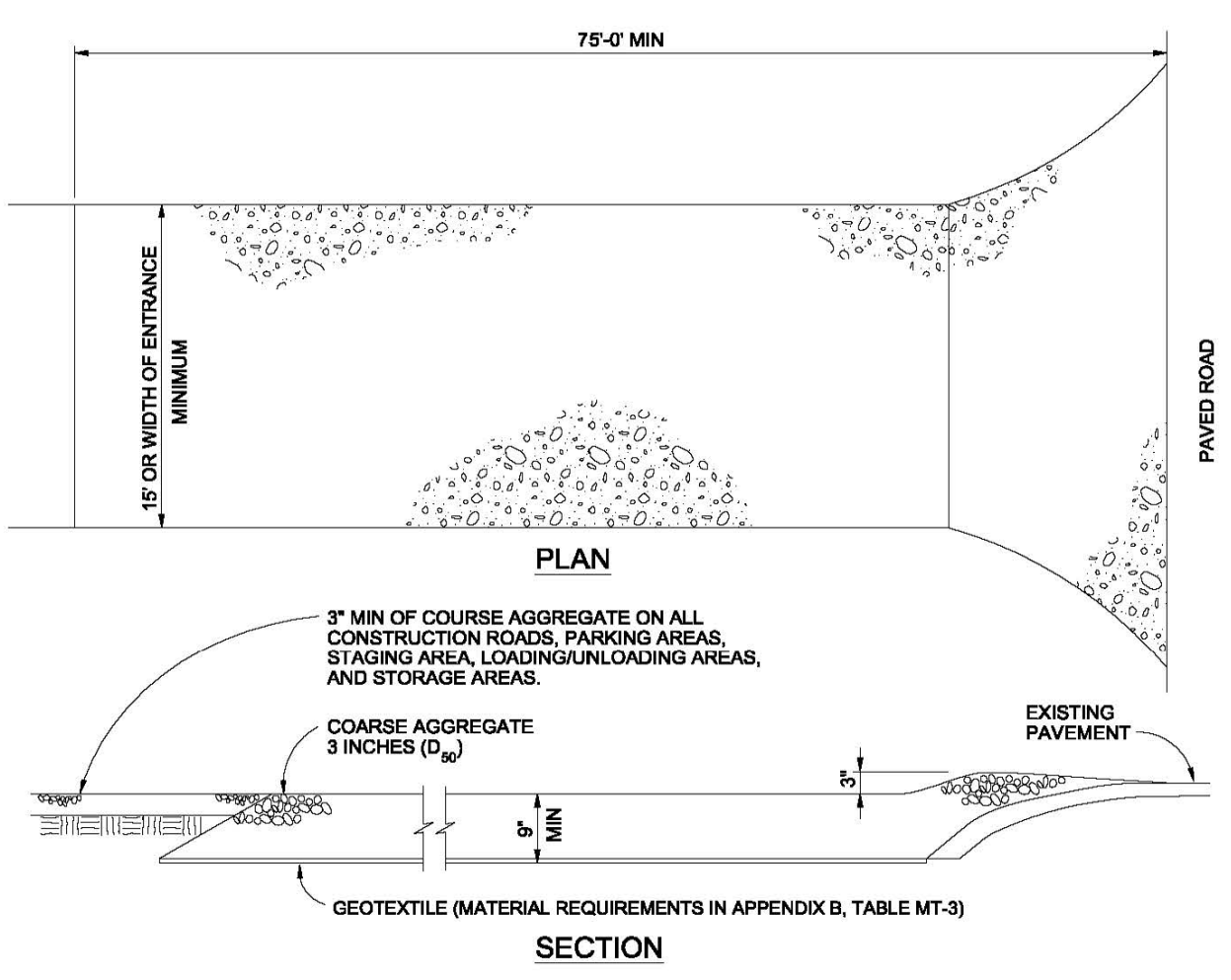

VEHICLE TRACKING NOTES

INSTALLATION REQUIREMENTS

1. ALL ENTRANCES TO THE CONSTRUCTION SITE ARE TO BE STABILIZED PRIOR TO CONSTRUCTION BEGINNING.
2. CONSTRUCTION ENTRANCES ARE TO BE BUILT WITH AN APRON TO ALLOW FOR TURNING TRAFFIC, BUT SHOULD NOT BE BUILT OVER EXISTING PAVEMENT EXCEPT FOR A SLIGHT OVERLAP.
3. AREAS TO BE STABILIZED ARE TO BE PROPERLY GRADED AND COMPACTED PRIOR TO LAYING DOWN GEOTEXTILE AND STONE.
4. CONSTRUCTION ROADS, PARKING AREAS, LOADING/UNLOADING ZONES, STORAGE AREAS, AND STAGING AREAS ARE TO BE STABILIZED.
5. CONSTRUCTION ROADS ARE TO BE BUILT TO CONFORM TO SITE GRADES, BUT SHOULD NOT HAVE SIDE SLOPES OR ROAD GRADES THAT ARE EXCESSIVELY STEEP.

MAINTENANCE REQUIREMENTS

1. REGULAR INSPECTIONS ARE TO BE MADE OF ALL STABILIZED AREAS, ESPECIALLY AFTER STORM EVENTS.
2. STONES ARE TO BE REPLACED PERIODICALLY AND WHEN REPAIR IS NECESSARY.
3. SEDIMENT TRACKED ONTO PAVED ROADS IS TO BE REMOVED DAILY BY SHOVELING OR SWEEPING. SEDIMENT IS NOT TO BE WASHED DOWN STORM SEWER DRAINS.
4. STORM SEWER INLET PROTECTION IS TO BE IN PLACE, INSPECTED, AND CLEANED IF NECESSARY.
5. OTHER ASSOCIATED SEDIMENT CONTROL MEASURES ARE TO BE INSPECTED TO ENSURE GOOD WORKING CONDITION.

City of Colorado Springs Stormwater Quality **Figure VT-2 Vehicle Tracking Application Examples**

DRAWN BY: D.E. WATTS
 DATE: 1-29-21
 DWG. NO.: 20-5523-06
 SURVEYED BY: DEV, ESW, 10-6-20

APPROVED BY:
 PROJ. NO.
 DWG.

REVISIONS

OLIVER E. WATTS
 CONSULTING ENGINEER
 COLORADO SPRINGS

PROJECT
 FALCON STORAGE PARCEL
 PART W 1/2 SEC. 1, T.13S., R.65W., 6TH P.M.
 EL PASO COUNTY

SHT. NO.
GRADING AND EROSION CONTROL PLAN

4 OF 4