



LSC TRANSPORTATION CONSULTANTS, INC.  
2504 East Pikes Peak Avenue, Suite 304  
Colorado Springs, CO 80909  
(719) 633-2868  
FAX (719) 633-5430  
E-mail: [lsc@lsctrans.com](mailto:lsc@lsctrans.com)  
Website: <http://www.lsctrans.com>

Falcon Storage Expansion  
Transportation Memorandum  
PCD File Nos: PPR2144, PPR2232, MS232  
(LSC #S214430)  
July 17, 2023

**Traffic Engineer's Statement**

This traffic report and supporting information were prepared under my responsible charge and they comport with the standard of care. So far as is consistent with the standard of care, said report was prepared in general conformance with the criteria established by the County for traffic reports.



**Developer's Statement**

I, the Developer, have read and will comply with all commitments made on my behalf within this report.

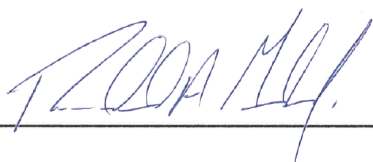
  
\_\_\_\_\_

7/24/2023  
\_\_\_\_\_

Date

# Falcon Storage Expansion Transportation Memorandum

Prepared for:  
Richard A. Graham, Jr.  
Graham Investments - General Partner  
4615 Northpark Drive, Suite 101  
Colorado Springs, CO 80918

JULY 17, 2023

---

LSC Transportation Consultants  
Prepared by: Jack Bauer &  
Jeffrey C. Hodsdon, P.E.

LSC #S214430

PCD File Nos. PPR2144, PPR2232, MS232



**CONTENTS**

REPORT CONTENTS ..... 1

ROAD AND TRAFFIC CONDITIONS ..... 2

    Existing Traffic Volumes ..... 3

PROPOSED LAND USE..... 3

SITE ACCESS..... 3

TRIP-GENERATION ESTIMATE..... 4

    Future Trip Generation ..... 4

    Existing Trip Generation Based on Count Data (Provided for Reference Only) ..... 4

        Single-Day Count ..... 4

        Annual Average ..... 5

TRIP DISTRIBUTION AND ASSIGNMENT..... 5

    Trip Directional Distribution..... 5

    Site-Generated Traffic..... 5

    Existing-Plus-Site-Generated Traffic Volumes ..... 5

    Estimated Future 2043 Background Traffic Volumes ..... 5

    Future 2043 Total Traffic Volumes ..... 5

LEVEL OF SERVICE ANALYSIS ..... 6

DRIVEWAY ACCESS EVALUATION ..... 6

    ECM Criteria for Driveway Access to a Collector Road ..... 6

    ECM Criteria for Access Design ..... 7

    Adequate Spacing ..... 7

    Access Alignment ..... 7

    Access Sight Distances..... 7

    Access Width..... 8

    Access “Throat” Length ..... 8

    Access Radii - AutoTurn Vehicle Turning Analysis ..... 8

    Clearances from Intersections..... 8

ROADWAY IMPROVEMENTS ..... 9

PERCENT IMPACT CALCULATIONS – VERIFICATION OF STUDY AREA ..... 9

AUXILIARY TURN-LANE ANALYSIS..... 10

ROADWAY IMPROVEMENT FEE PROGRAM..... 10

Enclosures: ..... 10

Table 4

Figures 1-8

Traffic Count Reports

Level of Service Reports

AutoTurn Exhibits 1-4

Site Plan



LSC TRANSPORTATION CONSULTANTS, INC.  
2504 E. Pikes Peak Ave., Suite 304  
Colorado Springs, CO 80909  
(719) 633-2868  
FAX (719) 633-5430  
E-mail: [lsc@lsctrans.com](mailto:lsc@lsctrans.com)  
Website: <http://www.lsctrans.com>

July 17, 2023

Falcon Storage, LLC  
c/o Richard A. Graham, Jr.  
Graham Investments - General Partner  
4615 Northpark Drive, Suite 101  
Colorado Springs, CO 80918

RE: Falcon Storage Expansion  
Transportation Memorandum  
PCD File Nos. PPR2144, PPR2232, MS232  
El Paso County, CO  
LSC #S214430

Dear Mr. Graham,

LSC Transportation Consultants, Inc. has prepared this Transportation Memorandum for the proposed Falcon Storage expansion in El Paso County, Colorado. The 5-acre expansion site is located on the north side of the existing Falcon Storage facility on the west side of Bent Grass Meadows Drive approximately 1/2-mile north of Woodmen North Frontage Road (El Paso County parcel ID 5301000018). One additional full-movement access point to Bent Grass Meadows Drive is proposed for the property. The existing full-movement access (located 747 feet south of the proposed expansion site access) would remain.

## REPORT CONTENTS

The preparation of this report included the following:

- An inventory of existing roadway and traffic conditions on the adjacent and nearby roadway system, including surface conditions, functional classification, jurisdictional control, widths, pavement markings, traffic-control signs, posted speed limits, intersection and access spacing, roadway and intersection alignments, roadway grades, and auxiliary turn lanes;
- Review of recent traffic reports in the area utilizing data, traffic projections, report findings, etc., as applicable;
- Summary of peak-hour traffic-count data at the existing access point on Bent Grass Meadows;
- Estimates of the average weekday 24-hour and peak-hour trip generation for the proposed RV storage site expansion;

- Estimation of the directional distribution of site-generated vehicle trips to the north and south on Bent Grass Meadows Drive;
- Sight distance analysis at the proposed site-access point to determine if it would meet minimum criteria in El Paso County's *Engineering Criteria Manual (ECM)*;
- Short-term and long-term projected intersection volumes at the access point to determine the potential need for any new auxiliary right-/left-turn lanes and/or the adequacy of existing lanes, based on the access criteria in the *ECM*;
- Level of Service analysis at the existing and proposed site-access point;
- Evaluation of the proposed site-access point with respect to the *Engineering Criteria Manual (ECM)* design criteria contained in Section 2.4.1; and
- Summary of compiled data, analysis, findings, and recommendations.

## ROAD AND TRAFFIC CONDITIONS

The attached site plan shows the streets adjacent to and in the vicinity of the site. Adjacent streets serving the site are identified below, followed by a brief description of each:

**Bent Grass Meadows Drive** is a Non-Residential Collector that currently extends north from the Woodmen North Frontage Road for about 2,000 feet and east to Meridian Road. The posted speed limit is 35 miles per hour (mph) and the street is 52-feet wide (flowline to flowline) adjacent to the proposed north access location.

**Meridian Road** is shown on the *El Paso County 2040 Major Transportation Corridors Plan* and the *Preserved Corridor Network Plan* as a four-lane Principal Arterial.

**Woodmen Road** is shown on the *El Paso County 2040 Major Transportation Corridors Plan* and the *Preserved Corridor Network Plan* as a four-lane Expressway in the vicinity of the site. The posted speed limit on Woodmen Road in the vicinity is 55 mph.

**Woodmen North Frontage Road** is a paved two-lane frontage road along the north side of Woodmen Road. The Woodmen frontage road extends west from just west of Meridian Road to its current terminus west of Golden Sage Road. The Woodmen North Frontage Road will soon be extended east through the Falcon Marketplace development to the intersection of Meridian Road/Eastonville Road.

### Existing Traffic Volumes

Vehicular turning-movement counts were conducted at the following intersections, dates, and times:

- Bent Grass Meadows Drive/existing site access
  - Wednesday, May 3, 2023 from 6:30 – 8:30 a.m.
  - Wednesday, May 3, 2023 from 4:00 – 6:00 p.m.
- Bent Grass Meadows Drive/Woodmen Frontage Road
  - Wednesday, May 3, 2023 from 6:30 – 8:30 a.m.
  - Wednesday, May 3, 2023 from 4:00 – 6:00 p.m.

Figure 3 shows these turning-movement volumes, as well as the estimated current average weekday traffic volumes on the study-area streets. Raw count data is attached.

### PROPOSED LAND USE

Currently, the storage site consists of 218 RV storage spaces. Following site expansion, an additional 92 RV storage spaces would be added, bringing the site total to 310 RV storage spaces.

### SITE ACCESS

The 5-acre site is located on the west side of Bent Grass Meadows Drive approximately 1/2-mile north of Woodmen North Frontage Road (El Paso County parcel ID 5301000018). One additional full-movement, paved access point to Bent Grass Meadows Drive is proposed for the property. The existing full-movement access (located about 375 feet south of the expansion site south property line) would remain. Figure 2 shows the site plan. The proposed access spacing is indicated in Figure 2. A copy of the full site plan is attached for reference.

### ACCESS SIGHT DISTANCE

Sight distance field measurements utilized a driver's eye height of 3.5 feet and a height of 3.5 feet for a vehicle traveling along Bent Grass Meadows Drive. The following analysis corresponds to field-measured sight distances for the proposed site-access driveway with Bent Grass Meadows Drive. Field-measured sight distances for passenger vehicles are as follows:

- North site access
  - To the north: 876 feet
  - To the south: greater than ¼ mile

Bent Grass Meadows Boulevard north and south of the site access has a relatively straight horizontal alignment and no vertical curves within the 350-foot passenger-vehicle and 455-foot single-unit truck requirements for *ECM*-standard sight distance. Site landscaping, signs, buildings, and any other features should not be placed within the *ECM*-required line of sight "triangles" to the north and south of the access points.

## TRIP-GENERATION ESTIMATE

Typically, estimates of the vehicle trips projected to be generated by a proposed development are made using the nationally-published average trip-generation rates from the following land-use codes in *Trip Generation, 11<sup>th</sup> Edition, 2021* by the Institute of Transportation Engineers (ITE). However, RV/Boat Storage trip-generation rates are not available for the proposed land use. As such, trip-generation rates for this site have been based on other studies completed for RV-storage facilities. Please refer to Appendix A for details. Existing morning and afternoon peak-hour trip generation, based on count data, has also been included in the table (for reference only).

Table 1 below presents a summary of the estimated additional site trip generation. A detailed trip-generation estimate for the site, including trip-generation rates for the proposed land uses, is presented in Table 4 (attached).

**Table 1: Estimated Additional Site Vehicle-Trip Generation**

Analysis Period	Weekday		
	In	Out	Total
Morning peak hour (vehicle trips/hour)	<1	<1	1
Evening peak hour (vehicle trips/hour)	1	1	2
Weekday – 24-hour total (vehicle trips/day)	6	6	12

### Future Trip Generation

Based on the trip-generation estimate for the entire site, Falcon Storage, LLC would generate about 114 vehicle trips on the average weekday, with half entering and half exiting the site. During the weekday morning peak hour, approximately 4 vehicles would enter and 4 vehicles would exit the site. During the weekday afternoon peak hour, approximately 6 vehicles would enter, and 6 vehicles would exit the site.

### Existing Trip Generation Based on Count Data (Provided for Reference Only)

#### Single-Day Count

The mini-warehouse facility and existing storage facility generated 11 entering and 7 exiting trips during the afternoon peak hour (4:30pm – 5:30pm) on the day which traffic volumes were recorded.



### Annual Average

The applicant provided records of all entering and exiting vehicles from the previous 12 months. On average, the mini-warehouse facility and existing storage facility generates 2 entering and 2 exiting trips during the afternoon peak hour.

## **TRIP DISTRIBUTION AND ASSIGNMENT**

### **Trip Directional Distribution**

Estimating the directional distribution of site-generated vehicle trips to the study-area roads and intersections is a necessary component in determining the site's traffic impacts. Figure 4 shows the percentages of the site-generated vehicle trips projected to be oriented to and from the site's major approaches. Estimates have been based on the following factors: the proposed new land use, the area street and road system serving the site, and the site's geographic location relative to the balance of the City of Colorado Springs and the Pikes Peak region.

### **Site-Generated Traffic**

Figure 5 shows the projected site-generated traffic volumes for the weekday morning and evening peak hours. Site-generated traffic volumes at the study-area intersections have been calculated by applying the directional-distribution percentages estimated by LSC (from Figure 4) to the trip-generation estimates (from Table 4).

### **Existing-Plus-Site-Generated Traffic Volumes**

Figure 6 shows the sum of the adjusted existing traffic volumes (from Figure 3) and site-generated peak-hour traffic volumes (shown in Figure 5). These volumes represent the projected short-term total traffic, following site buildout.

### **Estimated Future 2043 Background Traffic Volumes**

Figure 7 shows the projected 20-year background traffic volumes for the year 2043. Background volumes include/account for general traffic growth in the area, including trips to be generated by other area future developments on Bent Grass Meadows Drive. Projected site-generated trips from this site are **not** included in the 2043 Background volume estimates.

### **Future 2043 Total Traffic Volumes**

Figure 8 shows the projected 2043 total traffic volumes, which are the sum of 2043 background traffic volumes (from Figure 7) plus the site-generated traffic volumes (from Figure 5).

## LEVEL OF SERVICE ANALYSIS

Level of service (LOS) is a quantitative measure of the level of congestion or delay at an intersection and is indicated on a scale from “A” to “F.” LOS A is indicative of little congestion or delay. LOS F indicates a high level of congestion or delay. Table 2 shows the level of service delay ranges for signalized and unsignalized intersections.

**Table 2: Intersection Levels of Service Delay Ranges**

Level of Service	Signalized Intersections	Unsignalized Intersections
	Average Control Delay (Seconds per Vehicle)	Average Control Delay (Seconds per Vehicle) <sup>(1)</sup>
A	10.0 sec or less	10.0 sec or less
B	10.1-20.0 sec	10.1-15.0 sec
C	20.1-35.0 sec	15.1-25.0 sec
D	35.1-55.0 sec	25.1-35.0 sec
E	55.1-80.0 sec	35.1-50.0 sec
F	80.1 sec or more	50.1 sec or more

(1) For unsignalized intersections, if V/C ratio is greater than 1.0 the level of service is LOS F, regardless of the projected average control delay per vehicle.

All single-lane approaches and individual turning movements at the study-area intersections currently operate at and are projected to remain at LOS B or better following the addition of site-generated traffic and in the long-term horizon year. Please refer to the attached figures, which graphically show the results. Detailed Synchro reports (attached) contain additional details.

## DRIVEWAY ACCESS EVALUATION

### ECM Criteria for Driveway Access to a Collector Road

Bent Grass Meadows Drive is a Non-Residential Collector roadway. *ECM* criteria states that driveway access is not permitted. However, this site is not served by any other roadway. There is an existing driveway access to Bent Grass Meadows Drive.

### **ECM Criteria for Access Design**

One additional site-access point/driveway is proposed to Bent Grass Meadows Drive. The following summarizes *Engineering Criteria Manual* Section 2.4.1 access criteria, which states the following five access-design guidelines:

- Adequate spacing
- Proper alignments
- Clear sight distances
- Coordinated widths with its intended use
- Clearances from intersections

The following sections address each of these criteria for the proposed site driveway.

#### **Adequate Spacing**

Please refer to Figure 2 for the proposed spacing. *ECM* criteria states that:

*Accesses shall be separated by a distance equal to the entering sight distance values in Table 2-35. When turn lanes are present or will be needed in the future, the accesses shall be separated by a sufficient distance so that exclusive turn lanes including tapers will not overlap. Access shall not be permitted within a turn lane. Warrant criteria, design, and construction of turn lanes shall be governed by the requirements contained in Section 2.3.7D.*

The spacing to the intersection to the north is 225 feet (Rowena Way). The prescribed minimum “sight distance along the roadway” is 225 feet and the proposed access point would be 225 feet south of the Rowena Way intersection to the north. The spacing to the existing site access to the south is about 770 feet. No turn lanes are required for this proposed access point and Bent Grass Meadows Drive is striped with a two-way, center left-turn lane.

#### **Access Alignment**

The site plan shows the proposed additional site-access point aligned at 90 degrees to the adjacent Bent Grass Meadows Drive centerline.

#### **Access Sight Distances**

Access sight-distance criteria in section 2.4.1.D would apply:

*“Any potentially obstructing objects, such as but not limited to advertising signs, structures, trees, and bushes, shall be designed, placed, and maintained at a height not to interfere with the sight distance needed by any vehicle using the access.”*

The ECM-required entering sight distance would be met at the proposed site-access point. As indicated in the criteria quoted above, site improvements, as well as roadside slopes, walls, etc. should not impede the required sight-distance lines of sight.

### **Access Width**

The site plan (attached) shows a 30-foot-wide driveway width for the proposed north site-access point. Per ECM Section 2.4.1.E.1, “two-way commercial or industrial access points shall have a 25-foot minimum and a 40-foot maximum width for Non-Residential Collector roadways.”

### **Access “Throat” Length**

LSC recommends a 65-foot stacking distance between the entry gates and the west edge of Bent Grass Meadows Drive. This would allow for a Class-A RV, 30-foot-long single-unit truck, or a 35-foot-long U-Haul truck (largest size), plus an additional 30 feet to allow for a towed utility trailer, moving trailer, or following passenger vehicle.

### **Access Radii - AutoTurn Vehicle Turning Analysis**

LSC has completed an AutoTurn analysis to determine the radii necessary to accommodate the design vehicles at the proposed north site access. Detailed AutoTurn analysis exhibits depicting entering and exiting vehicle-movement wheel paths are attached as AutoTurn Exhibits 1a, 1b, 2a, and 2b. The site plan was revised based on the AutoTurn results.

### **Clearances from Intersections**

The ECM criteria reads as follows:

*“Access to commercial or industrial parcels fronting Nonresidential Collector roadways shall be located a minimum of 115 - 480 feet from the point of curvature or point of tangency of the curb line at the intersection depending on the sight distance and location with respect to the intersection, intersection control, and posted speed.  
In all cases, a minimum corner clearance of 50 feet shall be provided.”*

The spacing between the proposed site driveway and the intersection to the north is 225 feet (Rowena Way). Please refer to above paragraph on “Adequate Spacing.”

**ROADWAY IMPROVEMENTS**

- Given the projected low trip generation, auxiliary turn lanes would not be necessary on Bent Grass Meadows Drive with this development. The Non-Residential Collector cross section allows for potential future striping for a center, two-way left-turn lane (or dedicated left-turn lanes). Note: the standard Non-Residential Collector cross-section includes a two-way, center left-turn lane.
- This project may be required to participate in a fair and equitable manner towards future improvements at the following intersections. Any required pro-rata share would be a small amount due to the low relative traffic impacts (**less than one-half of one percent**)
  - Golden Sage/Woodmen Frontage Road
  - Golden Sage/Woodmen Road
  - Woodmen Frontage Road/Bent Grass Meadows Drive

**PERCENT IMPACT CALCULATIONS – VERIFICATION OF STUDY AREA**

Table 3 presents the percent impact calculations for off-site intersections near the site:

- Projected Falcon Storage expansion traffic would **not** increase existing traffic by 5 percent or more at any off-site intersection with LOS E or F (as shown in LSC’s Falcon Meadows at Bent Grass report).
- Projected Falcon Storage expansion traffic would **not** increase existing traffic by 10 percent or more at any off-site intersection with LOS D or better (as shown in LSC’s Falcon Meadows at Bent Grass report).

Therefore, the off-site intersection of Meridian Road/Bent Grass Meadows Road (shown in the nearby Falcon Meadows at Bent Grass traffic study report) is **not** required to be added as part of this site’s analysis.

**Table 3: Percent Impact Calculations (Meridian/Bent Grass Meadows)**

Location	Existing		Site-Generated		% Increase vs. Existing	
	AM	PM	AM	PM	AM	PM
SBR	167	134	< 1	1	0.2%	0.4%
SBT	1412	1378			0.0%	0.0%
NBT	576	511			0.0%	0.0%
NBL	81	68	< 1	< 1	0.4%	0.8%
EBR	90	98	< 1	1	0.2%	1.0%
EBL	95	85	< 1	1	0.2%	1.1%
<b>Total</b>	<b>2421</b>	<b>2274</b>	<b>&lt; 1</b>	<b>3</b>	<b>0.0%</b>	<b>0.1%</b>

### **AUXILIARY TURN-LANE ANALYSIS**

Bent Grass Meadows Drive is striped with a center two-way left-turn lane (TWLTL) adjacent to the proposed site access. As such, no modifications would be required to accommodate a northbound left-turn lane. Projected southbound right-turn volumes would not exceed the *ECM* 50-vph threshold, which would not trigger a right-turn lane at the new site-access point.

### **ROADWAY IMPROVEMENT FEE PROGRAM**

This site is located within the Woodmen Road Metropolitan District, and as such will be required to pay applicable Woodmen Road District fees in lieu of participation in the El Paso County Road Improvement Fee Program.

\* \* \* \* \*

Please contact me if you have any questions.

Respectfully Submitted,

LSC TRANSPORTATION CONSULTANTS, INC.

By: Jeffrey C. Hodsdon, P.E.  
Principal

JCH/JAB:jas

Enclosures: Table 4  
Figures 1-8  
Traffic Count Reports  
Level of Service Reports  
AutoTurn Exhibits 1-4  
Appendix A  
Site Plan

**Table 4**



**Table 4: Trip-Generation Table**

ITE		Value	Units <sup>1</sup>	Trip Generation Rates					Total Trips Generated				
Code	Description			Average Weekday	A.M.		P.M.		Average Weekday	A.M.		P.M.	
<b>Trip Generation Estimate Based on ITE Rates<sup>2</sup> and Locally-Derived Rates<sup>3</sup></b>													
<b>Existing Site</b>													
-	RV/Vehicle/Boat Storage	2.18	100 Parking Spaces	12.94	0.50	0.47	0.65	0.80	28	1	1	1	2
151	Mini-Warehouse	4.11	HSU	17.96	0.71	0.68	0.98	0.98	74	3	3	4	4
<b>Total</b>									<b>102</b>	<b>4</b>	<b>4</b>	<b>5</b>	<b>6</b>
<b>Proposed Additional RV Storage Spaces</b>													
-	RV/Vehicle/Boat Storage	0.92	100 Parking Spaces	12.94	0.50	0.47	0.65	0.80	12	0	0	1	1
<b>Total</b>									<b>12</b>	<b>0</b>	<b>0</b>	<b>1</b>	<b>1</b>
<b>Total Site Buildout</b>													
-	RV/Vehicle/Boat Storage	3.10	100 Parking Spaces	12.94	0.50	0.47	0.65	0.80	40	2	1	2	2
151	Mini-Warehouse	4.11	HSU	17.96	0.71	0.68	0.98	0.98	74	3	3	4	4
<b>Total</b>									<b>114</b>	<b>4</b>	<b>4</b>	<b>6</b>	<b>6</b>
<b>FOR REFERENCE ONLY -- Site Existing Trips Based on Actual Falcon Storage Count Data</b>													
<b>Existing Site (Average of Keypad Data from May 2020 to May 2021)</b>													
-	RV/Vehicle/Boat Storage	218	Occ. Spaces	-	-	-	-	-	20	1	1	1	1
151	Mini-Warehouse	4.11	HSU	-	-	-	-	-	21	1	1	1	1
<b>Total</b>									<b>41</b>	<b>2</b>	<b>2</b>	<b>2</b>	<b>2</b>
<b>Existing Site (Single-Day Count from 4:30pm to 5:30pm)</b>													
-	RV/Vehicle/Boat Storage	218	Occ. Spaces	-	-	-	-	-	-	-	-	-	-
151	Mini-Warehouse	4.11	HSU	-	-	-	-	-	-	-	-	-	-
<b>Total</b>									<b>-</b>	<b>-</b>	<b>-</b>	<b>11</b>	<b>7</b>
<sup>1</sup> HSU = storage units (in 100s) <sup>2</sup> Source: <i>Trip Generation</i> , 10th Edition, 2017, by the Institute of Transportation Engineers (ITE) <sup>3</sup> "RV/Vehicle Storage" rates - Please refer to Appendix A													
Updated by LSC: 07/14/2023													



# Figures 1-8

---





Not to scale

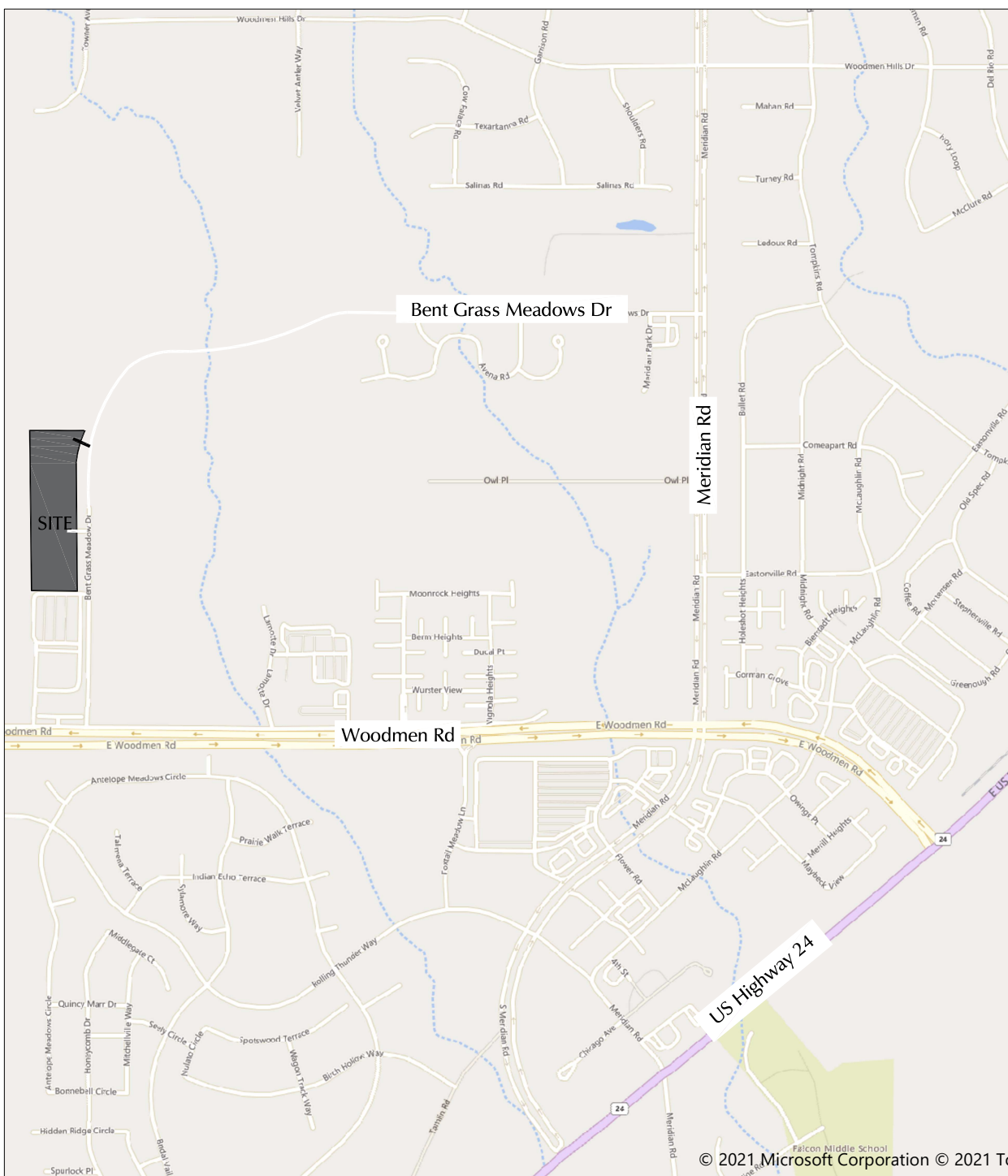
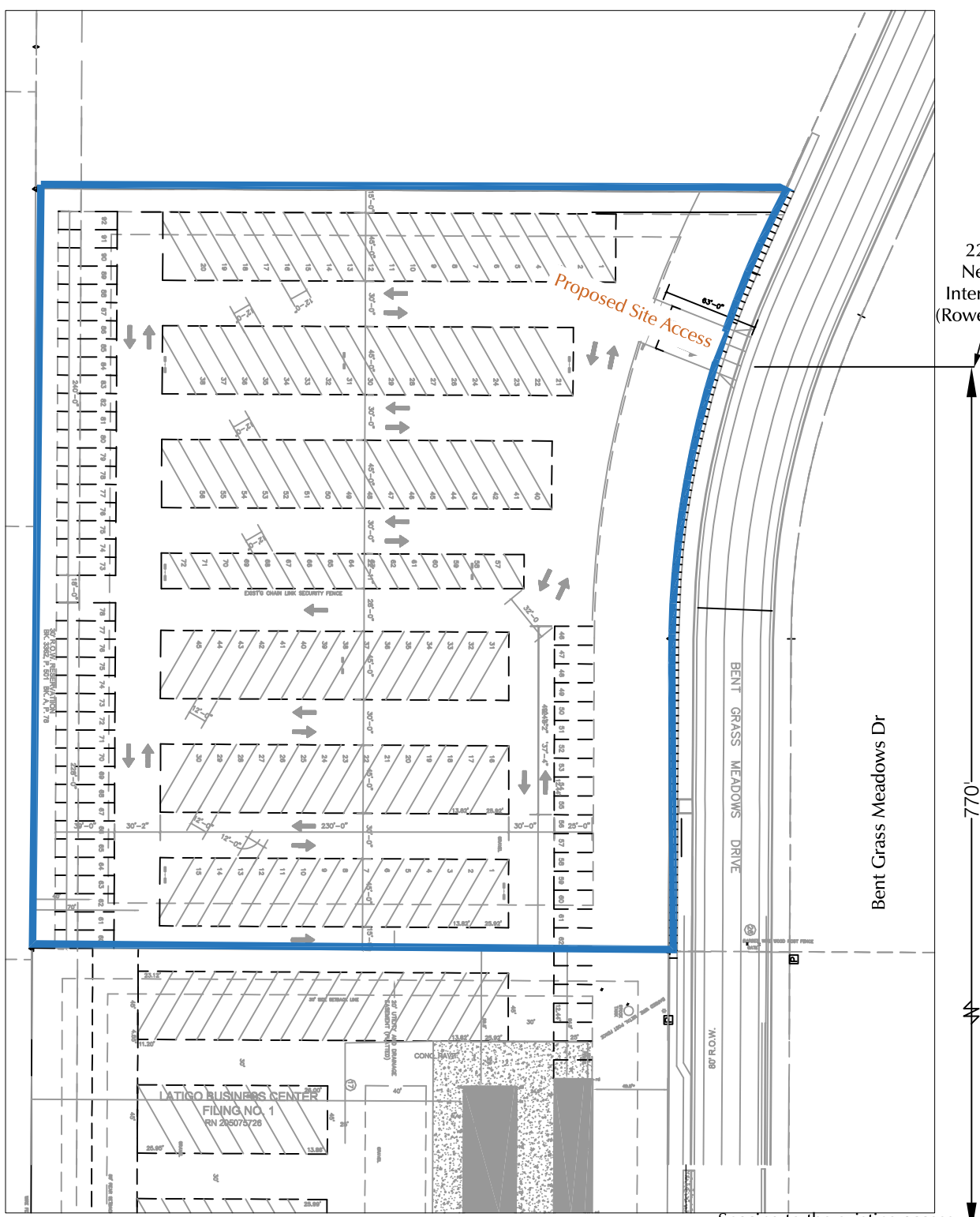



Figure 1  
**Vicinity Map**  
Falcon Storage LLC (LSC #S214430)



225' to Nearest Intersection (Rowena Way)



 Proposed site expansion boundary

Spacing to the existing access to the storage/U-Haul



Figure 2  
**Site Plan**

Falcon Storage LLC (LSC #S214430)

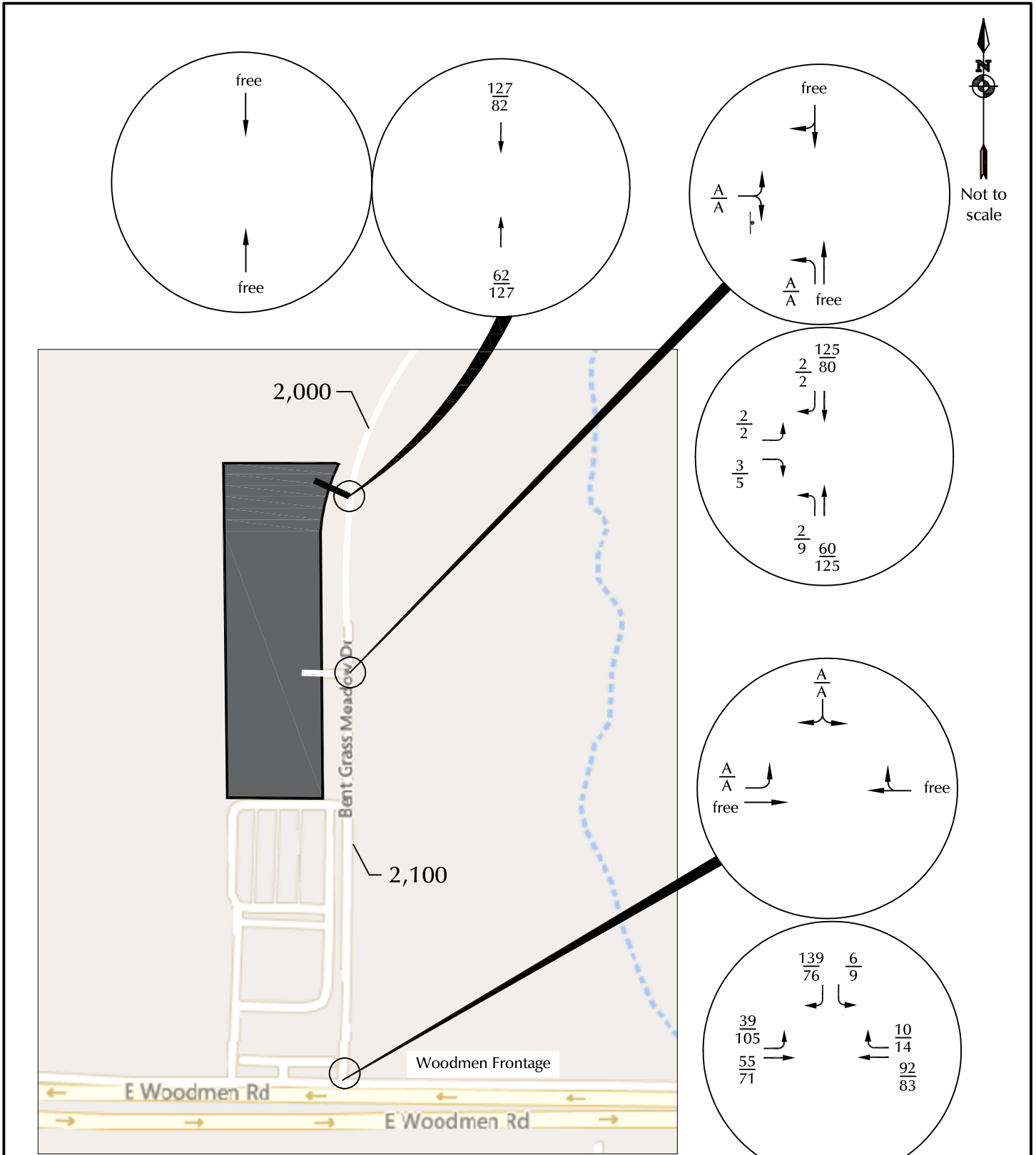

Counts by LSC (May 2023)

⊥ = Stop Sign

$\frac{X}{X}$  = AM Individual Movement Peak-Hour LOS

$\frac{X}{X}$  = PM Individual Movement Peak-Hour LOS

$\frac{XX}{XX}$  = AM Weekday Peak-Hour Traffic (Veh/Hour)

$\frac{XX}{XX}$  = PM Weekday Peak-Hour Traffic (Veh/Hour)

X,XXX = Average Daily Traffic (Vehicles/Day) - Estimated by LSC

Figure 3  
Existing Traffic, Lane  
Geometry, Traffic  
Control, and LOS

Falcon Storage LLC (LSC #S214430)



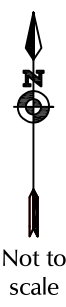

$\frac{XX\%}{XX\%}$  = A.M. Peak Hour % Distribution  
 $\frac{XX\%}{XX\%}$  = P.M. Peak Hour % Distribution

Figure 4  
**Directional Distribution**

Falcon Storage LLC (LSC #S214430)



From additional 92 RV storage spaces

Shifts to existing volumes due to proposed accesses

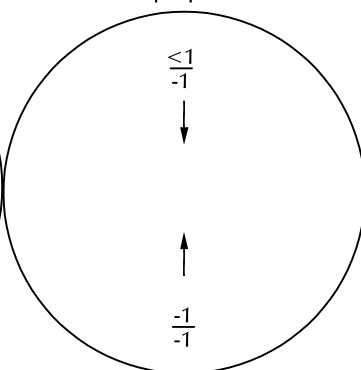
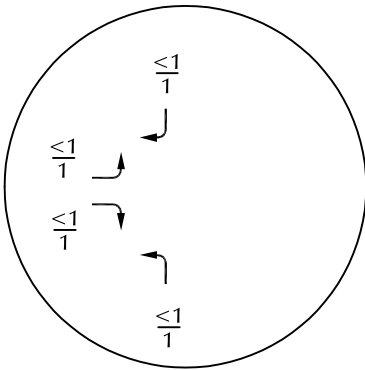

From additional 92 RV storage spaces

Shifts to existing volumes due to proposed accesses

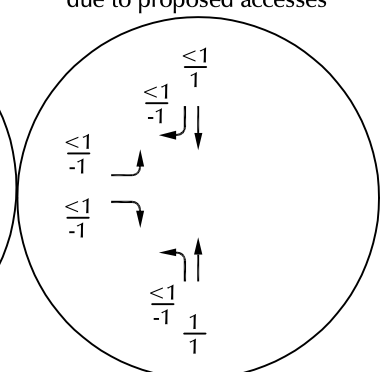
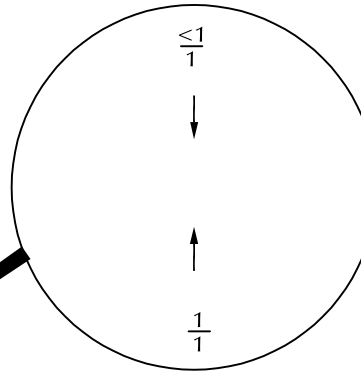

From additional 92 RV storage spaces

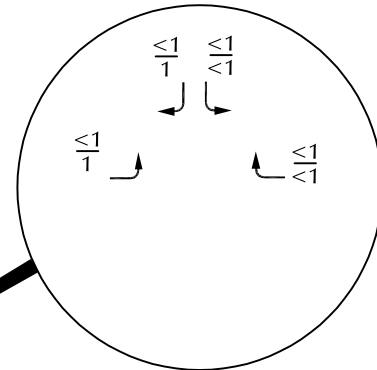

\* And traffic shift from the existing access point to the new access points



$\frac{XX}{XX}$  = AM Weekday Peak-Hour Traffic (Veh/Hour)  
 $\frac{XX}{XX}$  = PM Weekday Peak-Hour Traffic (Veh/Hour)  
 X,XXX = Average Daily Traffic (Vehicles/Day)

Figure 5  
**Additional Site-Generated Traffic\***

Falcon Storage LLC (LSC #S214430)

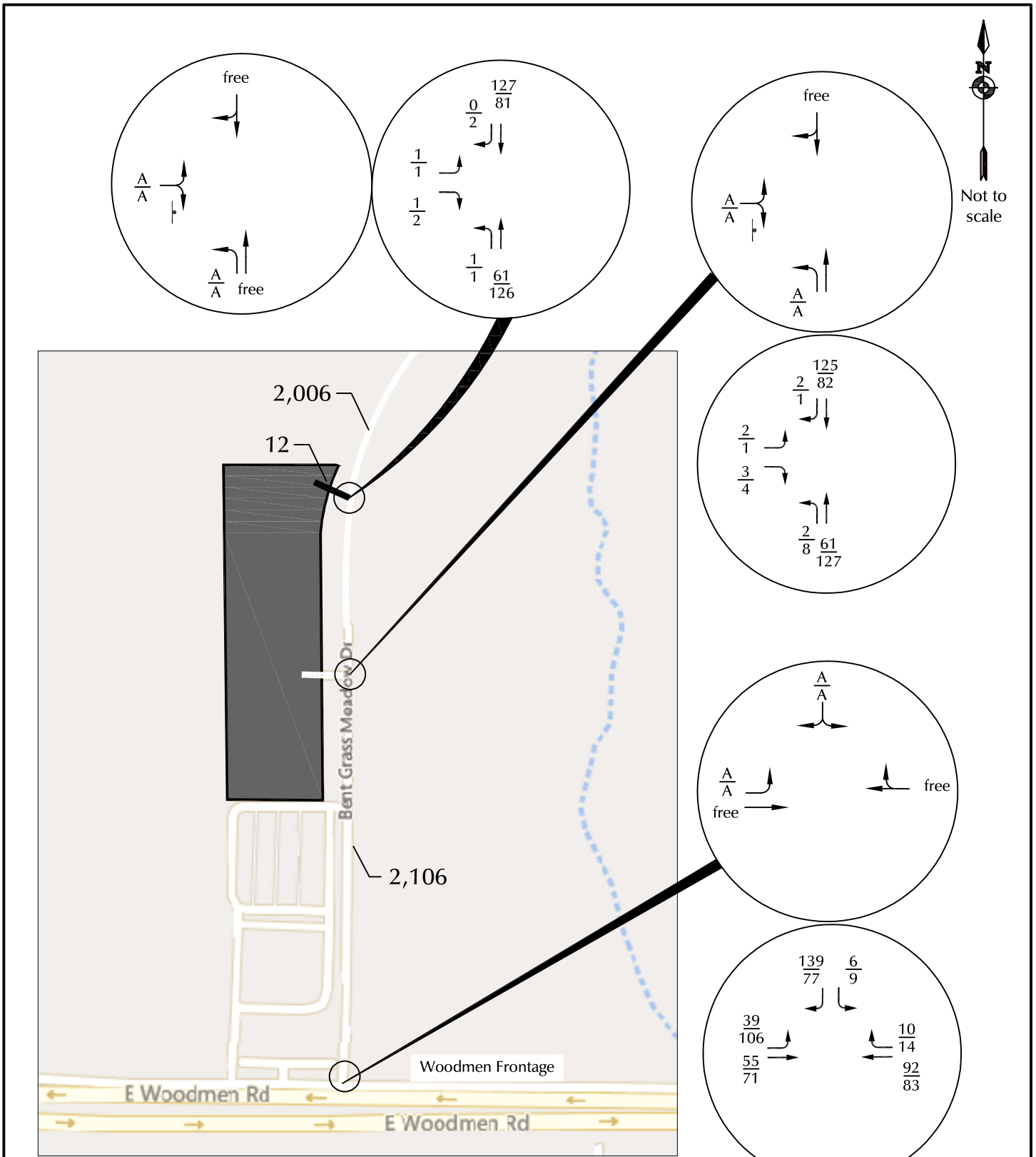

Counts by LSC (May 2023)

- ⊥ = Stop Sign
- X = AM Individual Movement Peak-Hour LOS
- X = PM Individual Movement Peak-Hour LOS
- XX = AM Weekday Peak-Hour Traffic (Veh/Hour)
- XX = PM Weekday Peak-Hour Traffic (Veh/Hour)

X,XXX = Average Daily Traffic (Vehicles/Day) - Estimated by LSC

Figure 6  
**Existing + Site-Generated  
 Traffic, Lane Geometry,  
 Traffic Control, and LOS**



Falcon Storage LLC (LSC #S214430)



Not to scale

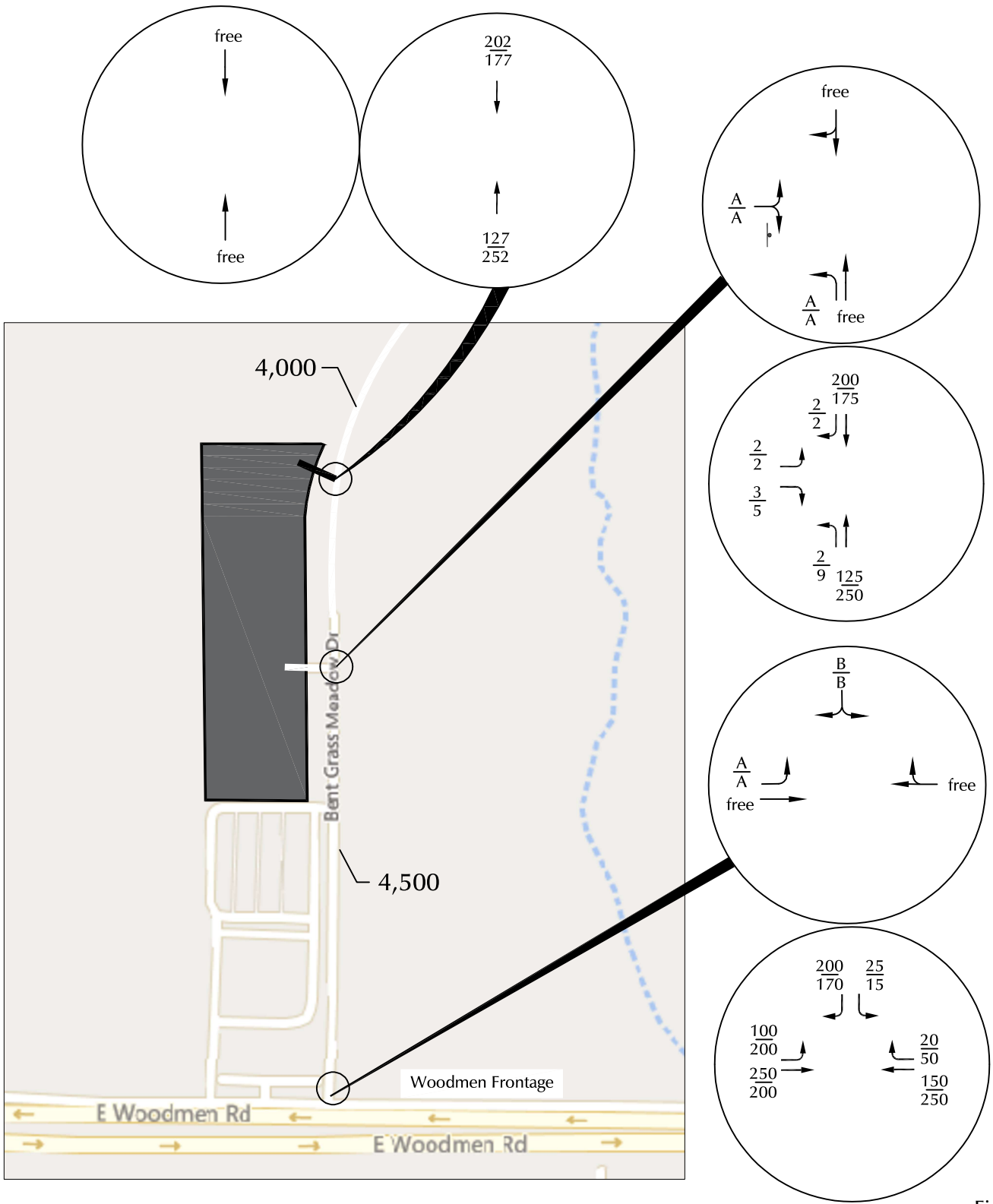

Figure 7

# 2043 Background Traffic, Lane Geometry, Traffic Control, and LOS

Falcon Storage LLC (LSC #S214430)



- ⊥ = Stop Sign
- $\frac{X}{X}$  =  $\frac{\text{AM Individual Movement Peak-Hour LOS}}{\text{PM Individual Movement Peak-Hour LOS}}$
- $\frac{XX}{XX}$  =  $\frac{\text{AM Weekday Peak-Hour Traffic (Veh/Hour)}}{\text{PM Weekday Peak-Hour Traffic (Veh/Hour)}}$
- X,XXX = Average Daily Traffic (Vehicles/Day) - Estimated by LSC



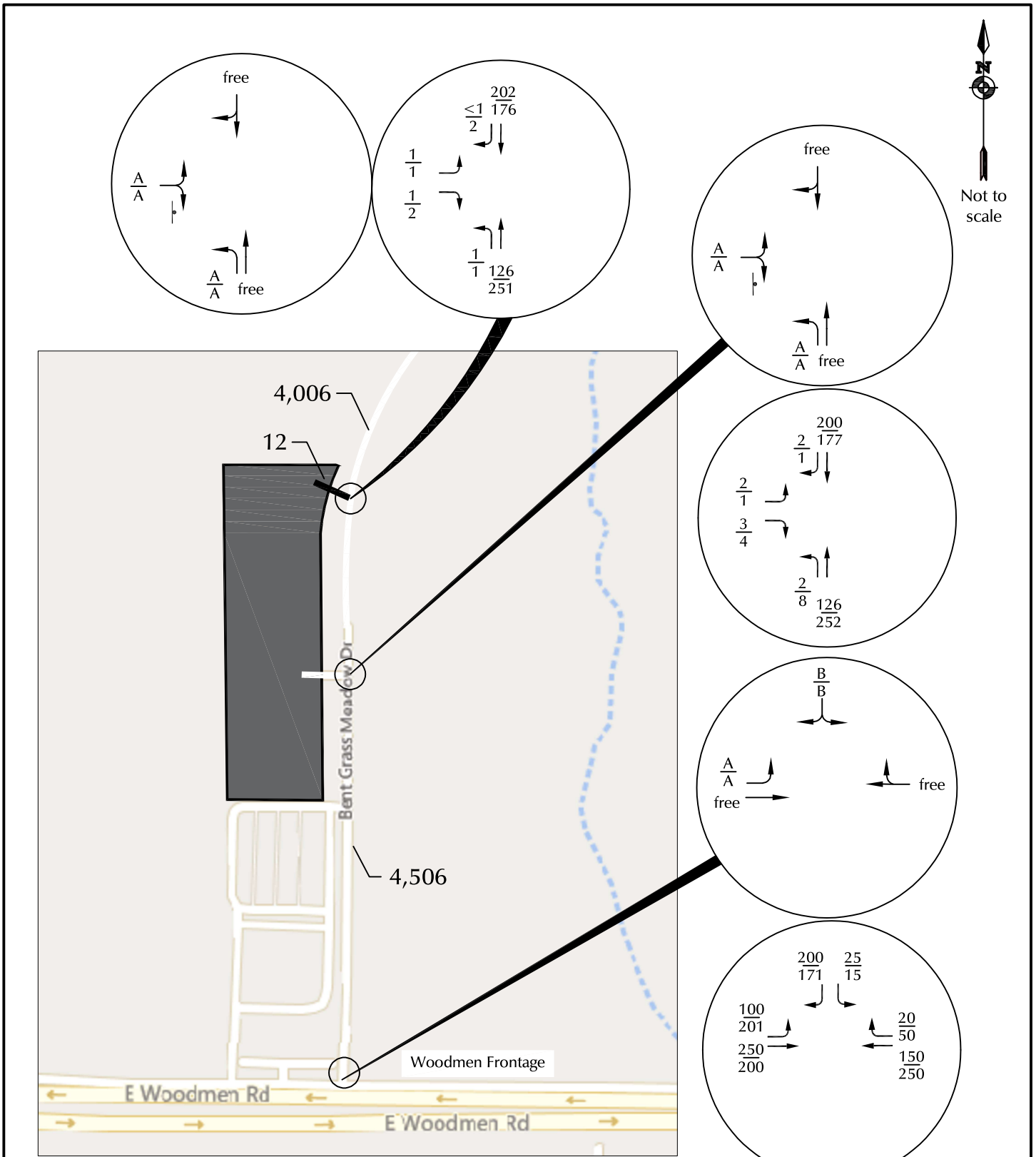

Figure 8

# 2043 Background + Site Traffic, Lane Geometry, Traffic Control, and LOS



- ⊥ = Stop Sign
- $\frac{X}{X}$  =  $\frac{\text{AM Individual Movement Peak-Hour LOS}}{\text{PM Individual Movement Peak-Hour LOS}}$
- $\frac{XX}{XX}$  =  $\frac{\text{AM Weekday Peak-Hour Traffic (Veh/Hour)}}{\text{PM Weekday Peak-Hour Traffic (Veh/Hour)}}$
- X,XXX = Average Daily Traffic (Vehicles/Day) - Estimated by LSC

# Traffic Counts

---



# LSC Transportation Consultants, Inc.

2504 E. Pikes Peak Ave, Suite 304  
 Colorado Springs, CO 80909  
 719-633-2868

File Name : Bent Grass Meadows - Woodmen Frontage Rd AM 5-23

Site Code : S214430

Start Date : 5/3/2023

Page No : 1

### Groups Printed- Unshifted

Start Time	Bent Grass Meadows Southbound					Woodmen Frontage Rd Westbound					Northbound					Woodmen Frontage Rd Eastbound					Int. Total
	Right	Thru	Left	Peds	App. Total	Right	Thru	Left	Peds	App. Total	Right	Thru	Left	Peds	App. Total	Right	Thru	Left	Peds	App. Total	
06:30	9	0	1	0	10	3	5	0	0	8	0	0	0	0	0	0	8	1	0	9	27
06:35	7	0	2	0	9	2	4	0	0	6	0	0	0	0	0	0	7	2	0	9	24
06:40	10	0	1	0	11	4	4	0	0	8	0	0	0	0	0	0	12	1	0	13	32
06:45	8	0	3	0	11	1	5	0	0	6	0	0	0	0	0	0	10	3	0	13	30
06:50	9	0	0	0	9	1	7	0	0	8	0	0	0	0	0	0	7	2	0	9	26
06:55	9	0	1	0	10	1	5	0	0	6	0	0	0	0	0	0	5	3	0	8	24
<b>Total</b>	<b>52</b>	<b>0</b>	<b>8</b>	<b>0</b>	<b>60</b>	<b>12</b>	<b>30</b>	<b>0</b>	<b>0</b>	<b>42</b>	<b>0</b>	<b>0</b>	<b>0</b>	<b>0</b>	<b>0</b>	<b>0</b>	<b>49</b>	<b>12</b>	<b>0</b>	<b>61</b>	<b>163</b>
07:00	14	0	0	0	14	1	6	0	0	7	0	0	0	0	0	0	6	2	0	8	29
07:05	16	0	0	0	16	0	9	0	0	9	0	0	0	0	0	0	1	6	0	7	32
07:10	14	0	0	0	14	0	10	0	0	10	0	0	0	0	0	0	2	1	0	3	27
07:15	9	0	0	0	9	0	14	0	0	14	0	0	0	0	0	0	3	4	0	7	30
07:20	7	0	0	0	7	0	8	0	0	8	0	0	0	0	0	0	2	3	0	5	20
07:25	15	0	0	0	15	1	8	0	0	9	0	0	0	0	0	0	3	6	0	9	33
07:30	10	0	0	0	10	0	8	0	0	8	0	0	0	0	0	0	2	2	0	4	22
07:35	18	0	1	0	19	1	8	0	0	9	0	0	0	0	0	0	2	6	0	8	36
07:40	13	0	2	0	15	0	6	0	0	6	0	0	0	0	0	0	6	0	0	6	27
07:45	9	0	1	0	10	0	3	0	0	3	0	0	0	0	0	0	3	5	0	8	21
07:50	8	0	0	0	8	1	2	0	0	3	0	0	0	0	0	0	3	5	0	8	19
07:55	6	0	1	0	7	0	6	0	0	6	0	0	0	0	0	0	3	3	0	6	19
<b>Total</b>	<b>139</b>	<b>0</b>	<b>5</b>	<b>0</b>	<b>144</b>	<b>4</b>	<b>88</b>	<b>0</b>	<b>0</b>	<b>92</b>	<b>0</b>	<b>0</b>	<b>0</b>	<b>0</b>	<b>0</b>	<b>0</b>	<b>36</b>	<b>43</b>	<b>0</b>	<b>79</b>	<b>315</b>
08:00	7	0	0	0	7	2	12	0	0	14	0	0	0	0	0	0	3	6	0	9	30
08:05	7	0	1	0	8	1	9	0	0	10	0	0	0	0	0	0	3	5	0	8	26
08:10	8	0	0	0	8	1	4	0	0	5	0	0	0	0	0	0	0	4	0	4	17
08:15	8	0	0	0	8	4	3	0	0	7	0	0	0	0	0	0	2	2	0	4	19
08:20	2	0	0	0	2	1	10	0	0	11	0	0	0	0	0	0	2	3	0	5	18
08:25	6	0	0	0	6	1	8	0	0	9	0	0	0	0	0	0	5	2	0	7	22
<b>Grand Total</b>	<b>229</b>	<b>0</b>	<b>14</b>	<b>0</b>	<b>243</b>	<b>26</b>	<b>164</b>	<b>0</b>	<b>0</b>	<b>190</b>	<b>0</b>	<b>0</b>	<b>0</b>	<b>0</b>	<b>0</b>	<b>0</b>	<b>100</b>	<b>77</b>	<b>0</b>	<b>177</b>	<b>610</b>
<b>Apprch %</b>	<b>94.2</b>	<b>0</b>	<b>5.8</b>	<b>0</b>		<b>13.7</b>	<b>86.3</b>	<b>0</b>	<b>0</b>		<b>0</b>	<b>0</b>	<b>0</b>	<b>0</b>		<b>0</b>	<b>56.5</b>	<b>43.5</b>	<b>0</b>		
<b>Total %</b>	<b>37.5</b>	<b>0</b>	<b>2.3</b>	<b>0</b>	<b>39.8</b>	<b>4.3</b>	<b>26.9</b>	<b>0</b>	<b>0</b>	<b>31.1</b>	<b>0</b>	<b>0</b>	<b>0</b>	<b>0</b>	<b>0</b>	<b>0</b>	<b>16.4</b>	<b>12.6</b>	<b>0</b>	<b>29</b>	

# LSC Transportation Consultants, Inc.

2504 E. Pikes Peak Ave, Suite 304  
 Colorado Springs, CO 80909  
 719-633-2868

File Name : Bent Grass Meadows - Woodmen Frontage Rd AM 5-23

Site Code : S214430

Start Date : 5/3/2023

Page No : 2

Start Time	Bent Grass Meadows Southbound					Woodmen Frontage Rd Westbound					Northbound					Woodmen Frontage Rd Eastbound					Int. Total
	Right	Thru	Left	Peds	App. Total	Right	Thru	Left	Peds	App. Total	Right	Thru	Left	Peds	App. Total	Right	Thru	Left	Peds	App. Total	
Peak Hour Analysis From 06:30 to 08:25 - Peak 1 of 1																					
Peak Hour for Entire Intersection Begins at 06:40																					
06:40	10	0	1	0	11	4	4	0	0	8	0	0	0	0	0	0	12	1	0	13	32
06:45	8	0	3	0	11	1	5	0	0	6	0	0	0	0	0	0	10	3	0	13	30
06:50	9	0	0	0	9	1	7	0	0	8	0	0	0	0	0	0	7	2	0	9	26
06:55	9	0	1	0	10	1	5	0	0	6	0	0	0	0	0	0	5	3	0	8	24
07:00	14	0	0	0	14	1	6	0	0	7	0	0	0	0	0	0	6	2	0	8	29
07:05	16	0	0	0	16	0	9	0	0	9	0	0	0	0	0	0	1	6	0	7	32
07:10	14	0	0	0	14	0	10	0	0	10	0	0	0	0	0	0	2	1	0	3	27
07:15	9	0	0	0	9	0	14	0	0	14	0	0	0	0	0	0	3	4	0	7	30
07:20	7	0	0	0	7	0	8	0	0	8	0	0	0	0	0	0	2	3	0	5	20
07:25	15	0	0	0	15	1	8	0	0	9	0	0	0	0	0	0	3	6	0	9	33
07:30	10	0	0	0	10	0	8	0	0	8	0	0	0	0	0	0	2	2	0	4	22
07:35	18	0	1	0	19	1	8	0	0	9	0	0	0	0	0	0	2	6	0	8	36
Total Volume	139	0	6	0	145	10	92	0	0	102	0	0	0	0	0	0	55	39	0	94	341
% App. Total	95.9	0	4.1	0		9.8	90.2	0	0		0	0	0	0		0	58.5	41.5	0		
PHF	.644	.000	.167	.000	.636	.208	.548	.000	.000	.607	.000	.000	.000	.000	.000	.000	.382	.542	.000	.603	.789

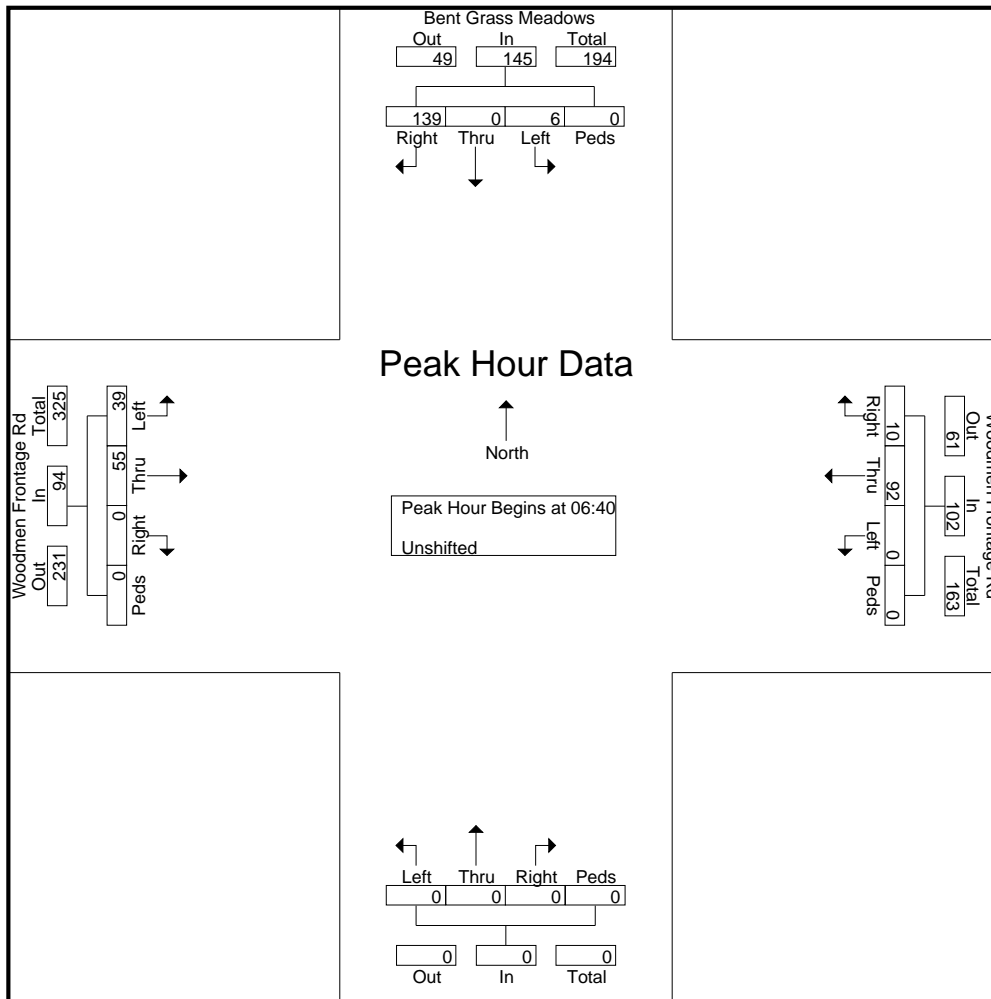

# LSC Transportation Consultants, Inc.

2504 E. Pikes Peak Ave, Suite 304  
 Colorado Springs, CO 80909  
 719-633-2868

File Name : Bent Grass Meadows - Woodmen Frontage Rd AM 5-23

Site Code : S214430

Start Date : 5/3/2023

Page No : 3

Start Time	Bent Grass Meadows Southbound					Woodmen Frontage Rd Westbound					Northbound					Woodmen Frontage Rd Eastbound					Int. Total
	Right	Thru	Left	Peds	App. Total	Right	Thru	Left	Peds	App. Total	Right	Thru	Left	Peds	App. Total	Right	Thru	Left	Peds	App. Total	

Peak Hour Analysis From 06:30 to 08:25 - Peak 1 of 1

Peak Hour for Each Approach Begins at:

	06:45					06:40					06:30					06:30				
+0 mins.	8	0	3	0	11	4	4	0	0	8	0	0	0	0	0	0	8	1	0	9
+5 mins.	9	0	0	0	9	1	5	0	0	6	0	0	0	0	0	0	7	2	0	9
+10 mins.	9	0	1	0	10	1	7	0	0	8	0	0	0	0	0	0	12	1	0	13
+15 mins.	14	0	0	0	14	1	5	0	0	6	0	0	0	0	0	0	10	3	0	13
+20 mins.	16	0	0	0	16	1	6	0	0	7	0	0	0	0	0	0	7	2	0	9
+25 mins.	14	0	0	0	14	0	9	0	0	9	0	0	0	0	0	0	5	3	0	8
+30 mins.	9	0	0	0	9	0	10	0	0	10	0	0	0	0	0	0	6	2	0	8
+35 mins.	7	0	0	0	7	0	14	0	0	14	0	0	0	0	0	0	1	6	0	7
+40 mins.	15	0	0	0	15	0	8	0	0	8	0	0	0	0	0	0	2	1	0	3
+45 mins.	10	0	0	0	10	1	8	0	0	9	0	0	0	0	0	0	3	4	0	7
+50 mins.	18	0	1	0	19	0	8	0	0	8	0	0	0	0	0	0	2	3	0	5
+55 mins.	13	0	2	0	15	1	8	0	0	9	0	0	0	0	0	0	3	6	0	9
Total Volume	142	0	7	0	149	10	92	0	0	102	0	0	0	0	0	0	66	34	0	100
% App. Total	95.3	0	4.7	0		9.8	90.2	0	0		0	0	0	0		0	66	34	0	
PHF	.657	.000	.194	.000	.654	.208	.548	.000	.000	.607	.000	.000	.000	.000	.000	.000	.458	.472	.000	.641

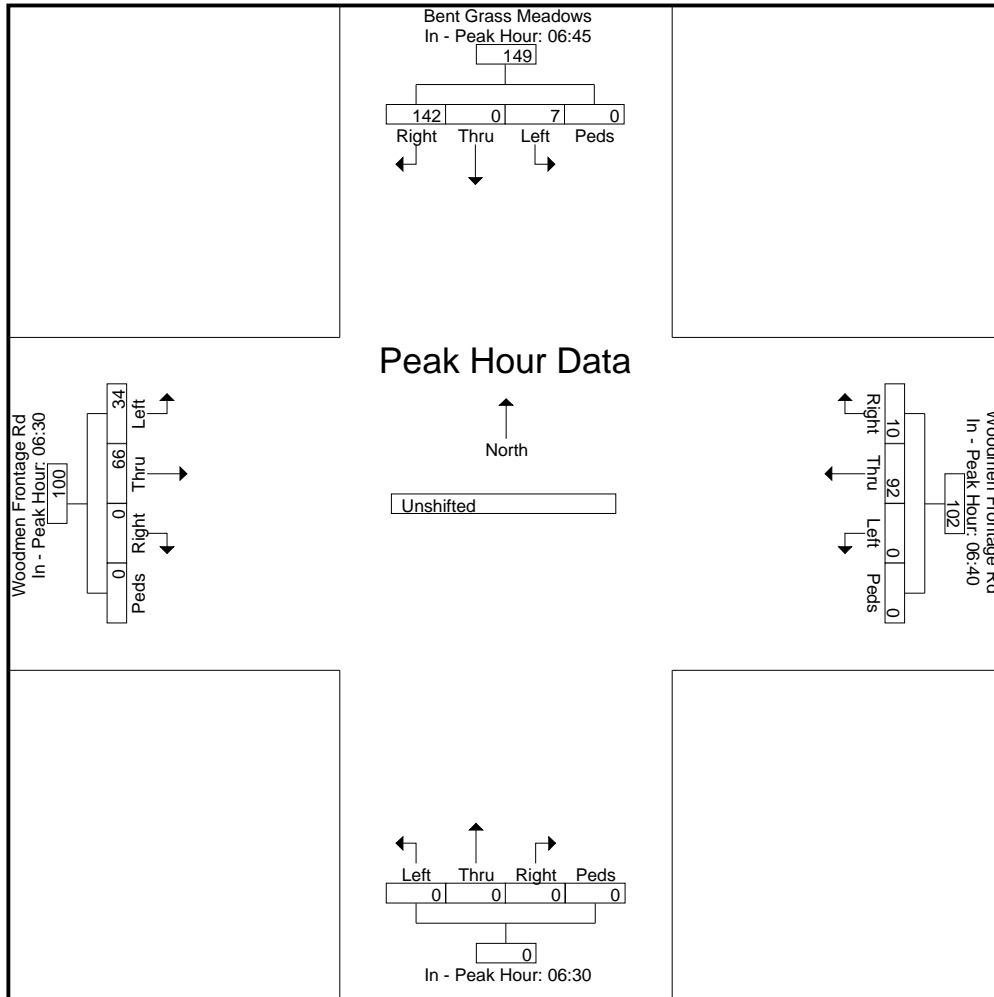

# **LSC Transportation Consultants, Inc.**

2504 E. Pikes Peak Ave, Suite 304

Colorado Springs, CO 80909

719-633-2868

# LSC Transportation Consultants, Inc.

2504 E. Pikes Peak Ave, Suite 304  
 Colorado Springs, CO 80909  
 719-633-2868

File Name : Bent Grass Meadows - Woodmen Frontage Rd PM 5-23

Site Code : S214430

Start Date : 5/3/2023

Page No : 1

### Groups Printed- Unshifted

Start Time	Bent Grass Meadows Southbound					Woodmen Frontage Rd Westbound					Northbound					Woodmen Frontage Rd Eastbound					Int. Total
	Right	Thru	Left	Peds	App. Total	Right	Thru	Left	Peds	App. Total	Right	Thru	Left	Peds	App. Total	Right	Thru	Left	Peds	App. Total	
16:00	5	0	1	0	6	1	3	0	0	4	0	0	0	0	0	0	2	8	0	10	20
16:05	5	0	2	0	7	1	4	0	0	5	0	0	0	0	0	0	8	9	0	17	29
16:10	4	0	1	0	5	0	6	0	0	6	0	0	0	0	0	0	5	11	0	16	27
16:15	2	0	0	0	2	0	15	0	0	15	0	0	0	0	0	0	6	9	0	15	32
16:20	7	0	0	0	7	0	5	0	0	5	0	0	0	0	0	0	4	10	0	14	26
16:25	6	0	1	0	7	2	9	0	0	11	0	0	0	0	0	0	7	7	0	14	32
16:30	3	0	1	0	4	0	10	0	0	10	0	0	0	0	0	0	6	7	0	13	27
16:35	7	0	0	0	7	0	5	0	0	5	0	0	0	0	0	0	4	8	0	12	24
16:40	8	0	1	0	9	0	4	0	0	4	0	0	0	0	0	0	10	11	0	21	34
16:45	8	0	3	0	11	0	9	0	0	9	0	0	0	0	0	0	9	9	0	18	38
16:50	9	0	0	0	9	1	7	0	0	8	0	0	0	0	0	0	7	8	0	15	32
16:55	5	0	1	0	6	2	2	0	0	4	0	0	0	0	0	0	7	8	0	15	25
<b>Total</b>	<b>69</b>	<b>0</b>	<b>11</b>	<b>0</b>	<b>80</b>	<b>7</b>	<b>79</b>	<b>0</b>	<b>0</b>	<b>86</b>	<b>0</b>	<b>0</b>	<b>0</b>	<b>0</b>	<b>0</b>	<b>0</b>	<b>75</b>	<b>105</b>	<b>0</b>	<b>180</b>	<b>346</b>
17:00	5	0	1	0	6	0	5	0	0	5	0	0	0	0	0	0	2	7	0	9	20
17:05	10	0	2	0	12	2	4	0	0	6	0	0	0	0	0	0	5	6	0	11	29
17:10	5	0	0	0	5	0	2	0	0	2	0	0	0	0	0	0	6	11	0	17	24
17:15	2	0	0	0	2	2	5	0	0	7	0	0	0	0	0	0	3	12	0	15	24
17:20	8	0	1	0	9	0	2	0	0	2	0	0	0	0	0	0	9	8	0	17	28
17:25	7	0	0	0	7	2	4	0	0	6	0	0	0	0	0	0	4	5	0	9	22
17:30	4	0	0	0	4	3	15	0	0	18	0	0	0	0	0	0	7	12	0	19	41
17:35	5	0	0	0	5	2	24	0	0	26	0	0	0	0	0	0	2	8	0	10	41
17:40	6	0	0	0	6	1	10	0	0	11	0	0	0	0	0	0	7	6	0	13	30
17:45	1	0	0	0	1	1	5	0	0	6	0	0	0	0	0	0	6	5	0	11	18
17:50	2	0	1	0	3	1	8	0	0	9	0	0	0	0	0	0	4	6	0	10	22
17:55	6	0	0	0	6	0	4	0	0	4	0	0	0	0	0	0	6	8	0	14	24
<b>Total</b>	<b>61</b>	<b>0</b>	<b>5</b>	<b>0</b>	<b>66</b>	<b>14</b>	<b>88</b>	<b>0</b>	<b>0</b>	<b>102</b>	<b>0</b>	<b>0</b>	<b>0</b>	<b>0</b>	<b>0</b>	<b>0</b>	<b>61</b>	<b>94</b>	<b>0</b>	<b>155</b>	<b>323</b>
<b>Grand Total</b>	<b>130</b>	<b>0</b>	<b>16</b>	<b>0</b>	<b>146</b>	<b>21</b>	<b>167</b>	<b>0</b>	<b>0</b>	<b>188</b>	<b>0</b>	<b>0</b>	<b>0</b>	<b>0</b>	<b>0</b>	<b>0</b>	<b>136</b>	<b>199</b>	<b>0</b>	<b>335</b>	<b>669</b>
<b>Apprch %</b>	<b>89</b>	<b>0</b>	<b>11</b>	<b>0</b>		<b>11.2</b>	<b>88.8</b>	<b>0</b>	<b>0</b>		<b>0</b>	<b>0</b>	<b>0</b>	<b>0</b>		<b>0</b>	<b>40.6</b>	<b>59.4</b>	<b>0</b>		
<b>Total %</b>	<b>19.4</b>	<b>0</b>	<b>2.4</b>	<b>0</b>	<b>21.8</b>	<b>3.1</b>	<b>25</b>	<b>0</b>	<b>0</b>	<b>28.1</b>	<b>0</b>	<b>0</b>	<b>0</b>	<b>0</b>	<b>0</b>	<b>0</b>	<b>20.3</b>	<b>29.7</b>	<b>0</b>	<b>50.1</b>	

# LSC Transportation Consultants, Inc.

2504 E. Pikes Peak Ave, Suite 304  
 Colorado Springs, CO 80909  
 719-633-2868

File Name : Bent Grass Meadows - Woodmen Frontage Rd PM 5-23

Site Code : S214430

Start Date : 5/3/2023

Page No : 2

Start Time	Bent Grass Meadows Southbound					Woodmen Frontage Rd Westbound					Northbound					Woodmen Frontage Rd Eastbound					Int. Total
	Right	Thru	Left	Peds	App. Total	Right	Thru	Left	Peds	App. Total	Right	Thru	Left	Peds	App. Total	Right	Thru	Left	Peds	App. Total	
Peak Hour Analysis From 16:00 to 17:55 - Peak 1 of 1																					
Peak Hour for Entire Intersection Begins at 16:40																					
16:40	8	0	1	0	9	0	4	0	0	4	0	0	0	0	0	0	10	11	0	21	34
16:45	8	0	3	0	11	0	9	0	0	9	0	0	0	0	0	0	9	9	0	18	38
16:50	9	0	0	0	9	1	7	0	0	8	0	0	0	0	0	0	7	8	0	15	32
16:55	5	0	1	0	6	2	2	0	0	4	0	0	0	0	0	0	7	8	0	15	25
17:00	5	0	1	0	6	0	5	0	0	5	0	0	0	0	0	0	2	7	0	9	20
17:05	10	0	2	0	12	2	4	0	0	6	0	0	0	0	0	0	5	6	0	11	29
17:10	5	0	0	0	5	0	2	0	0	2	0	0	0	0	0	0	6	11	0	17	24
17:15	2	0	0	0	2	2	5	0	0	7	0	0	0	0	0	0	3	12	0	15	24
17:20	8	0	1	0	9	0	2	0	0	2	0	0	0	0	0	0	9	8	0	17	28
17:25	7	0	0	0	7	2	4	0	0	6	0	0	0	0	0	0	4	5	0	9	22
17:30	4	0	0	0	4	3	15	0	0	18	0	0	0	0	0	0	7	12	0	19	41
17:35	5	0	0	0	5	2	24	0	0	26	0	0	0	0	0	0	2	8	0	10	41
Total Volume	76	0	9	0	85	14	83	0	0	97	0	0	0	0	0	0	71	105	0	176	358
% App. Total	89.4	0	10.6	0		14.4	85.6	0	0		0	0	0	0		0	40.3	59.7	0		
PHF	.633	.000	.250	.000	.590	.389	.288	.000	.000	.311	.000	.000	.000	.000	.000	.000	.592	.729	.000	.698	.728

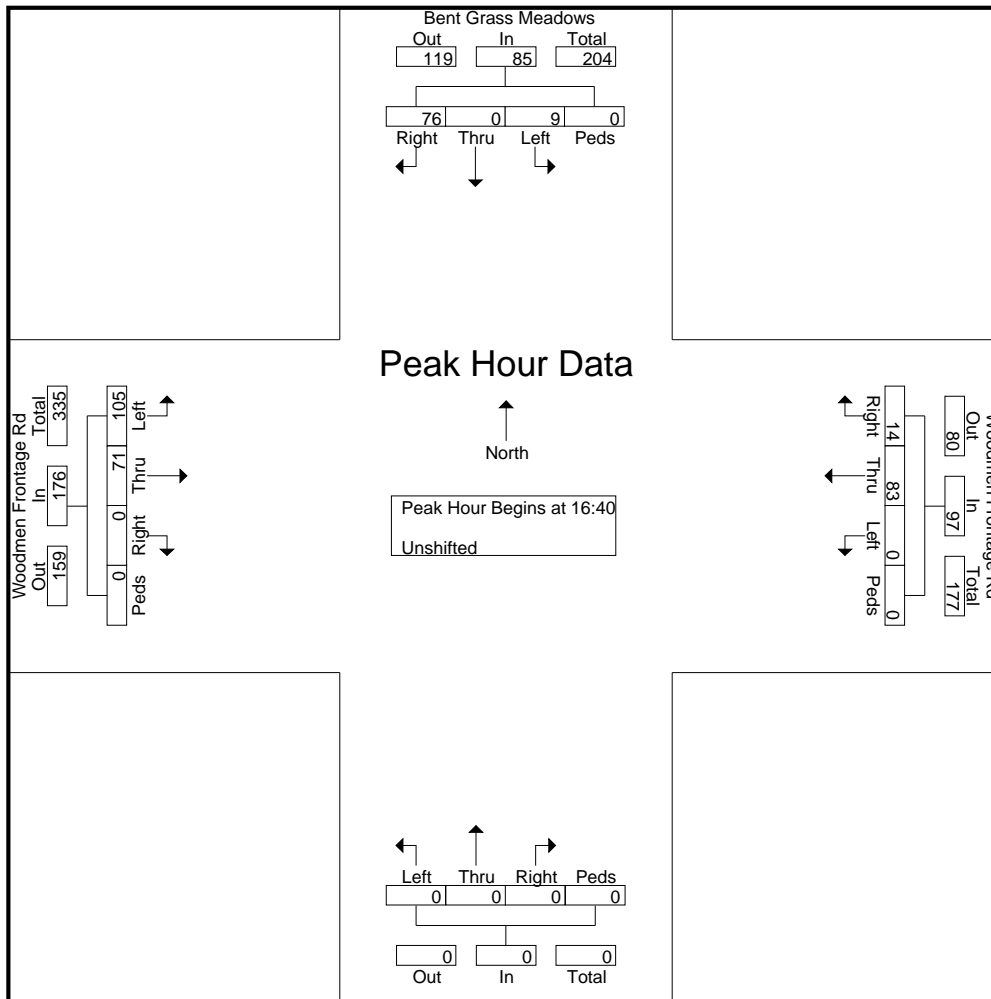



# LSC Transportation Consultants, Inc.

2504 E. Pikes Peak Ave, Suite 304  
 Colorado Springs, CO 80909  
 719-633-2868

File Name : Bent Grass Meadows - Woodmen Frontage Rd PM 5-23

Site Code : S214430

Start Date : 5/3/2023

Page No : 3

	Bent Grass Meadows Southbound					Woodmen Frontage Rd Westbound					Northbound					Woodmen Frontage Rd Eastbound					
Start Time	Right	Thru	Left	Peds	App. Total	Right	Thru	Left	Peds	App. Total	Right	Thru	Left	Peds	App. Total	Right	Thru	Left	Peds	App. Total	Int. Total

Peak Hour Analysis From 16:00 to 17:55 - Peak 1 of 1

Peak Hour for Each Approach Begins at:

	16:25					16:45					16:00					16:00				
+0 mins.	6	0	1	0	7	0	9	0	0	9	0	0	0	0	0	0	2	8	0	10
+5 mins.	3	0	1	0	4	1	7	0	0	8	0	0	0	0	0	0	8	9	0	17
+10 mins.	7	0	0	0	7	2	2	0	0	4	0	0	0	0	0	0	5	11	0	16
+15 mins.	8	0	1	0	9	0	5	0	0	5	0	0	0	0	0	0	6	9	0	15
+20 mins.	8	0	3	0	11	2	4	0	0	6	0	0	0	0	0	0	4	10	0	14
+25 mins.	9	0	0	0	9	0	2	0	0	2	0	0	0	0	0	0	7	7	0	14
+30 mins.	5	0	1	0	6	2	5	0	0	7	0	0	0	0	0	0	6	7	0	13
+35 mins.	5	0	1	0	6	0	2	0	0	2	0	0	0	0	0	0	4	8	0	12
+40 mins.	10	0	2	0	12	2	4	0	0	6	0	0	0	0	0	0	10	11	0	21
+45 mins.	5	0	0	0	5	3	15	0	0	18	0	0	0	0	0	0	9	9	0	18
+50 mins.	2	0	0	0	2	2	24	0	0	26	0	0	0	0	0	0	7	8	0	15
+55 mins.	8	0	1	0	9	1	10	0	0	11	0	0	0	0	0	0	7	8	0	15
Total Volume	76	0	11	0	87	15	89	0	0	104	0	0	0	0	0	0	75	105	0	180
% App. Total	87.4	0	12.6	0		14.4	85.6	0	0		0	0	0	0		0	41.7	58.3	0	
PHF	.633	.000	.306	.000	.604	.417	.309	.000	.000	.333	.000	.000	.000	.000	.000	.000	.625	.795	.000	.714

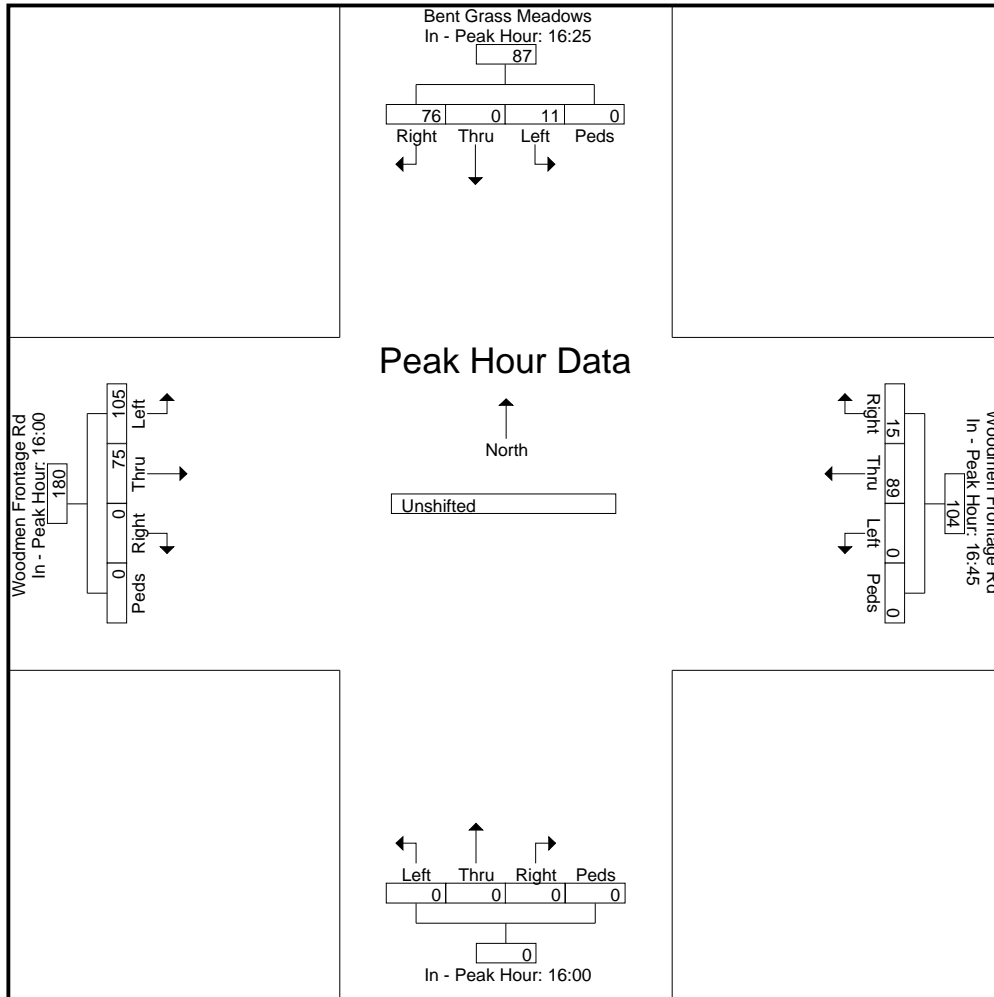

# **LSC Transportation Consultants, Inc.**

2504 E. Pikes Peak Ave, Suite 304

Colorado Springs, CO 80909

719-633-2868

# LSC Transportation Consultants, Inc.

545 E Pikes Peak Ave, Suite 210  
 Colorado Springs, CO 80905  
 719-633-2868

File Name : Falcon Storage PM Trucks & Trailers  
 Site Code : S214430  
 Start Date : 5/12/2021  
 Page No : 1

### Groups Printed- Bank 1

Start Time	Bent Grass Meadows Southbound					Westbound					Bent Grass Meadows Northbound					Falcon Storage Eastbound					Int. Total
	L	T	R	U	App. Total	L	T	R	U	App. Total	L	T	R	U	App. Total	L	T	R	U	App. Total	
04:00 PM	0	0	0	0	0	0	0	0	0	0	0	0	0	0	0	1	0	0	0	1	1
04:15 PM	0	0	0	0	0	0	0	0	0	0	0	0	0	0	0	1	0	1	0	2	2
*** BREAK ***																					
04:45 PM	0	0	0	0	0	0	0	0	0	0	2	0	0	0	2	0	0	0	0	0	2
Total	0	0	0	0	0	0	0	0	0	0	2	0	0	0	2	2	0	1	0	3	5
05:00 PM	0	0	0	0	0	0	0	0	0	0	0	0	0	0	0	0	0	1	0	1	1
05:15 PM	0	0	1	0	1	0	0	0	0	0	0	0	0	0	0	0	0	0	0	0	1
*** BREAK ***																					
Total	0	0	1	0	1	0	0	0	0	0	0	0	0	0	0	0	0	1	0	1	2
Grand Total	0	0	1	0	1	0	0	0	0	0	2	0	0	0	2	2	0	2	0	4	7
Apprch %	0	0	100	0		0	0	0	0		100	0	0	0		50	0	50	0		
Total %	0	0	14.3	0	14.3	0	0	0	0	0	28.6	0	0	0	28.6	28.6	0	28.6	0	57.1	

# LSC Transportation Consultants, Inc.

545 E Pikes Peak Ave, Suite 210  
 Colorado Springs, CO 80905  
 719-633-2868

File Name : Falcon Storage PM Trucks & Trailers  
 Site Code : S214430  
 Start Date : 5/12/2021  
 Page No : 2

Start Time	Bent Grass Meadows Southbound					Westbound					Bent Grass Meadows Northbound					Falcon Storage Eastbound					Int. Total
	L	T	R	U	App. Total	L	T	R	U	App. Total	L	T	R	U	App. Total	L	T	R	U	App. Total	
<b>Peak Hour Analysis From 4:00:00 PM to 5:45:00 PM - Peak 1 of 1</b>																					
Peak Hour for Entire Intersection Begins at 4:00:00 PM																					
4:00:00 PM	0	0	0	0	0	0	0	0	0	0	0	0	0	0	0	1	0	0	0	1	1
4:15:00 PM	0	0	0	0	0	0	0	0	0	0	0	0	0	0	0	1	0	1	0	2	2
4:30:00 PM	0	0	0	0	0	0	0	0	0	0	0	0	0	0	0	0	0	0	0	0	0
4:45:00 PM	0	0	0	0	0	0	0	0	0	0	2	0	0	0	2	0	0	0	0	0	2
Total Volume	0	0	0	0	0	0	0	0	0	0	2	0	0	0	2	2	0	1	0	3	5
% App. Total	0	0	0	0	0	0	0	0	0	0	100	0	0	0	2	66.7	0	33.3	0	0	0
PHF	.000	.000	.000	.000	.000	.000	.000	.000	.000	.000	.250	.000	.000	.000	.250	.500	.000	.250	.000	.375	.625

# LSC Transportation Consultants, Inc.

545 E Pikes Peak Ave, Suite 210  
 Colorado Springs, CO 80905  
 719-633-2868

File Name : Falcon Storage PM Trucks & Trailers  
 Site Code : S214430  
 Start Date : 5/12/2021  
 Page No : 3

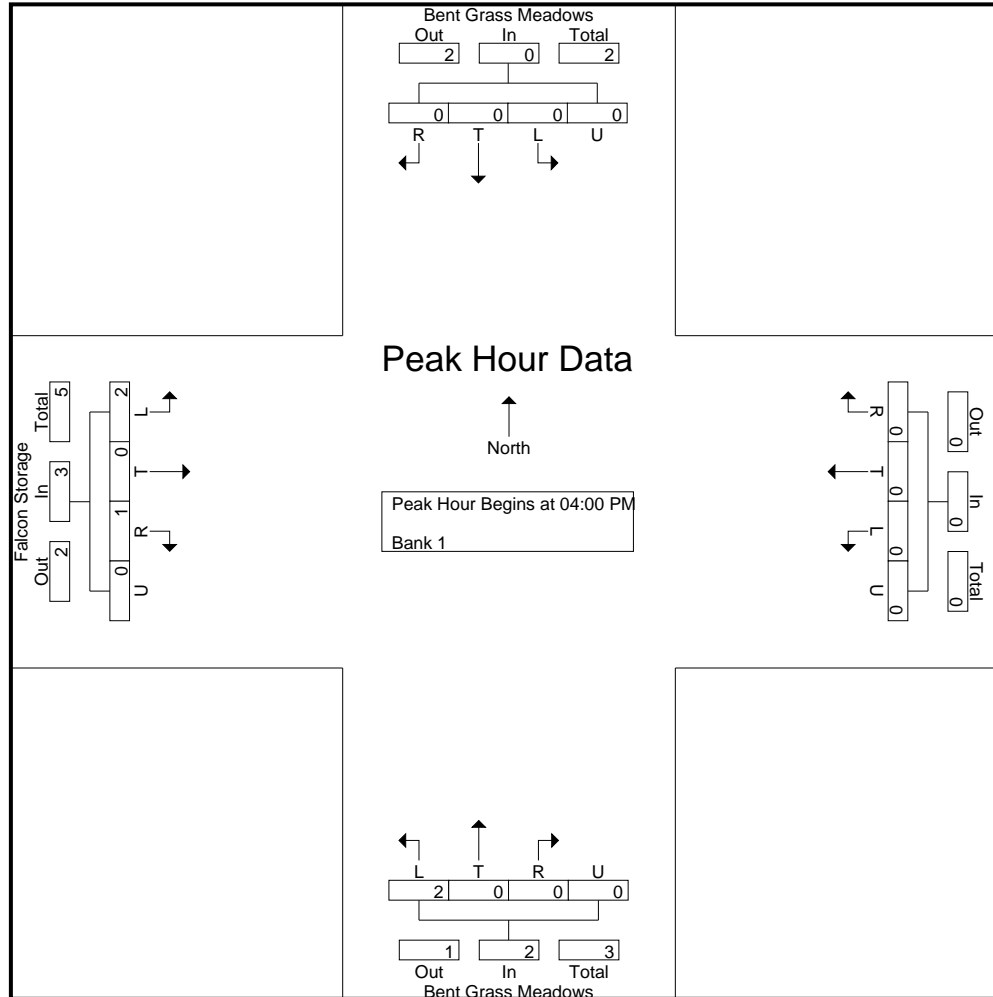

# LSC Transportation Consultants, Inc.

545 E Pikes Peak Ave, Suite 210  
 Colorado Springs, CO 80905  
 719-633-2868

File Name : Falcon Storage PM Trucks & Trailers  
 Site Code : S214430  
 Start Date : 5/12/2021  
 Page No : 4

Start Time	Bent Grass Meadows Southbound					Westbound					Bent Grass Meadows Northbound					Falcon Storage Eastbound					Int. Total
	L	T	R	U	App. Total	L	T	R	U	App. Total	L	T	R	U	App. Total	L	T	R	U	App. Total	
<b>Peak Hour Analysis From 4:00:00 PM to 5:45:00 PM - Peak 1 of 1</b>																					
Peak Hour for Each Approach Begins at:																					
	4:30:00 PM					4:00:00 PM					4:00:00 PM					4:00:00 PM					
+0 mins.	0	0	0	0	0	0	0	0	0	0	0	0	0	0	0	1	0	0	0	1	
+5 mins.	0	0	0	0	0	0	0	0	0	0	0	0	0	0	0	1	0	1	0	2	
+10 mins.	0	0	0	0	0	0	0	0	0	0	0	0	0	0	0	0	0	0	0	0	
+15 mins.	0	0	1	0	1	0	0	0	0	0	2	0	0	0	2	0	0	0	0	0	
Total Volume	0	0	1	0	1	0	0	0	0	0	2	0	0	0	2	2	0	1	0	3	
% App. Total	0	0	100	0		0	0	0	0		100	0	0	0		66.7	0	33.3	0		
PHF	.000	.000	.250	.000	.250	.000	.000	.000	.000	.000	.250	.000	.000	.000	.250	.500	.000	.250	.000	.375	

# LSC Transportation Consultants, Inc.

545 E Pikes Peak Ave, Suite 210  
Colorado Springs, CO 80905  
719-633-2868

File Name : Falcon Storage PM Trucks & Trailers  
Site Code : S214430  
Start Date : 5/12/2021  
Page No : 5

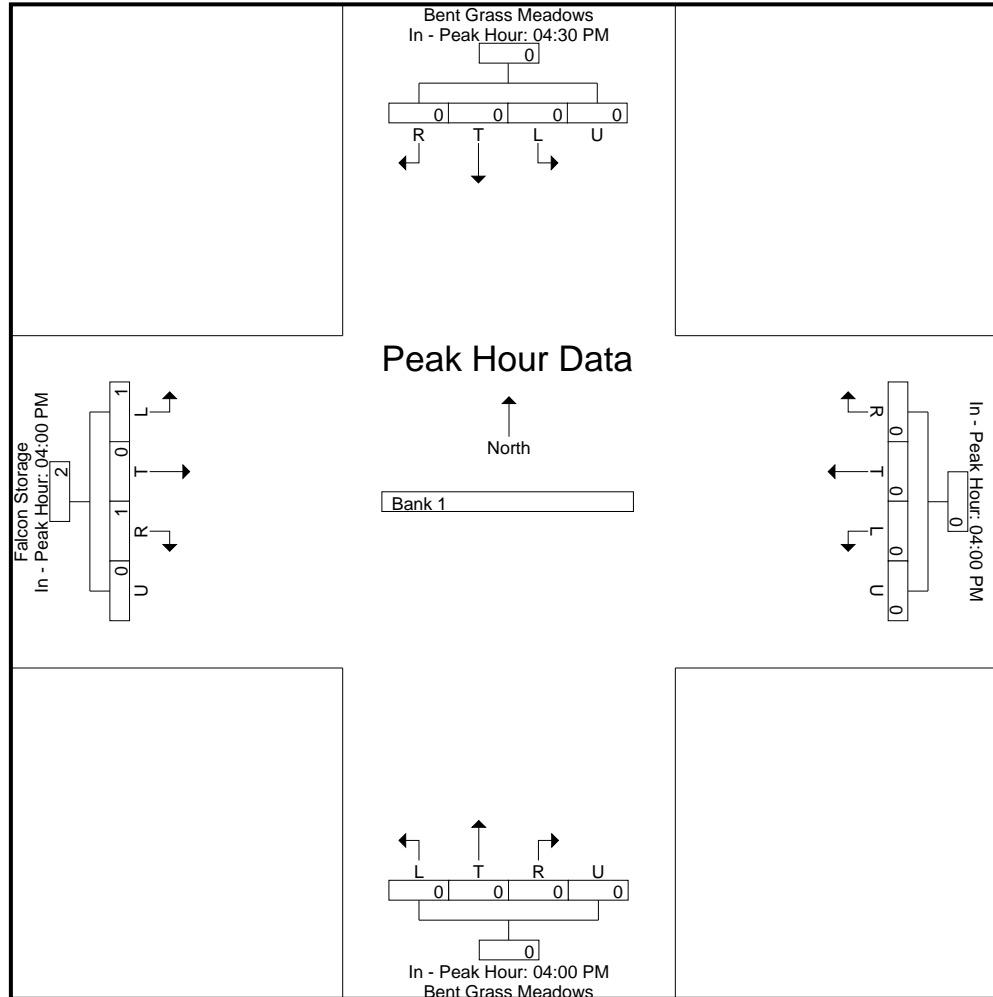

# LSC Transportation Consultants, Inc.

545 E Pikes Peak Ave, Suite 210  
 Colorado Springs, CO 80905  
 719-633-2868

File Name : Falcon Storage PM  
 Site Code : S214430  
 Start Date : 5/12/2021  
 Page No : 1

### Groups Printed- Unshifted

Start Time	Bent Grass Meadows Southbound					Westbound					Bent Grass Meadows Northbound					Falcon Storage Eastbound					Int. Total
	L	T	R	U	App. Total	L	T	R	U	App. Total	L	T	R	U	App. Total	L	T	R	U	App. Total	
04:00 PM	0	11	0	0	11	0	0	0	0	0	1	8	0	0	9	3	0	1	0	4	24
04:15 PM	0	13	0	0	13	0	0	0	0	0	0	9	0	0	9	2	0	2	0	4	26
04:30 PM	0	5	0	0	5	0	0	0	0	0	0	10	0	0	10	0	0	0	0	0	15
04:45 PM	0	5	0	0	5	0	0	0	0	0	3	11	0	0	14	0	0	1	0	1	20
Total	0	34	0	0	34	0	0	0	0	0	4	38	0	0	42	5	0	4	0	9	85
05:00 PM	0	5	0	0	5	0	0	0	0	0	3	6	0	0	9	0	0	4	0	4	18
05:15 PM	0	3	2	0	5	0	0	0	0	0	3	10	0	0	13	2	0	0	0	2	20
05:30 PM	0	3	0	0	3	0	0	0	0	0	0	10	0	0	10	0	0	0	0	0	13
05:45 PM	0	4	1	0	5	0	0	0	0	0	0	5	0	0	5	0	0	0	0	0	10
Total	0	15	3	0	18	0	0	0	0	0	6	31	0	0	37	2	0	4	0	6	61
Grand Total	0	49	3	0	52	0	0	0	0	0	10	69	0	0	79	7	0	8	0	15	146
Apprch %	0	94.2	5.8	0		0	0	0	0		12.7	87.3	0	0		46.7	0	53.3	0		
Total %	0	33.6	2.1	0	35.6	0	0	0	0	0	6.8	47.3	0	0	54.1	4.8	0	5.5	0	10.3	



# LSC Transportation Consultants, Inc.

545 E Pikes Peak Ave, Suite 210  
 Colorado Springs, CO 80905  
 719-633-2868

File Name : Falcon Storage PM  
 Site Code : S214430  
 Start Date : 5/12/2021  
 Page No : 2

Start Time	Bent Grass Meadows Southbound					Westbound					Bent Grass Meadows Northbound					Falcon Storage Eastbound					Int. Total
	L	T	R	U	App. Total	L	T	R	U	App. Total	L	T	R	U	App. Total	L	T	R	U	App. Total	
<b>Peak Hour Analysis From 4:00:00 PM to 5:45:00 PM - Peak 1 of 1</b>																					
Peak Hour for Entire Intersection Begins at 4:00:00 PM																					
4:00:00 PM	0	11	0	0	11	0	0	0	0	0	1	8	0	0	9	3	0	1	0	4	24
4:15:00 PM	0	13	0	0	13	0	0	0	0	0	0	9	0	0	9	2	0	2	0	4	26
4:30:00 PM	0	5	0	0	5	0	0	0	0	0	0	10	0	0	10	0	0	0	0	0	15
4:45:00 PM	0	5	0	0	5	0	0	0	0	0	3	11	0	0	14	0	0	1	0	1	20
Total Volume	0	34	0	0	34	0	0	0	0	0	4	38	0	0	42	5	0	4	0	9	85
% App. Total	0	100	0	0		0	0	0	0		9.5	90.5	0	0		55.6	0	44.4	0		
PHF	.000	.654	.000	.000	.654	.000	.000	.000	.000	.000	.333	.864	.000	.000	.750	.417	.000	.500	.000	.563	.817

# LSC Transportation Consultants, Inc.

545 E Pikes Peak Ave, Suite 210  
 Colorado Springs, CO 80905  
 719-633-2868

File Name : Falcon Storage PM  
 Site Code : S214430  
 Start Date : 5/12/2021  
 Page No : 3

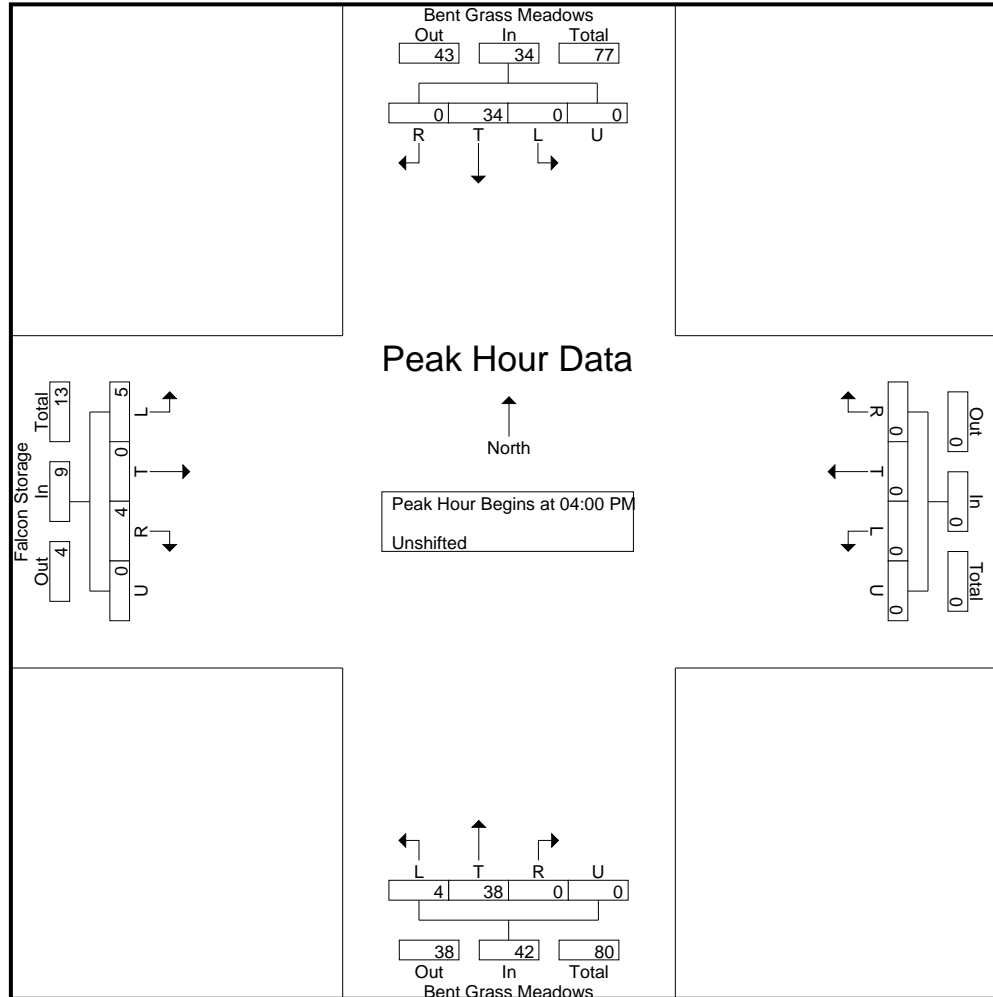

# LSC Transportation Consultants, Inc.

545 E Pikes Peak Ave, Suite 210  
 Colorado Springs, CO 80905  
 719-633-2868

File Name : Falcon Storage PM  
 Site Code : S214430  
 Start Date : 5/12/2021  
 Page No : 4

Start Time	Bent Grass Meadows Southbound					Westbound					Bent Grass Meadows Northbound					Falcon Storage Eastbound					Int. Total
	L	T	R	U	App. Total	L	T	R	U	App. Total	L	T	R	U	App. Total	L	T	R	U	App. Total	
<b>Peak Hour Analysis From 4:00:00 PM to 5:45:00 PM - Peak 1 of 1</b>																					
Peak Hour for Each Approach Begins at:																					
	4:00:00 PM					4:00:00 PM					4:30:00 PM					4:00:00 PM					
+0 mins.	0	11	0	0	11	0	0	0	0	0	0	10	0	0	10	3	0	1	0	4	
+5 mins.	0	13	0	0	13	0	0	0	0	0	3	11	0	0	14	2	0	2	0	4	
+10 mins.	0	5	0	0	5	0	0	0	0	0	3	6	0	0	9	0	0	0	0	0	
+15 mins.	0	5	0	0	5	0	0	0	0	0	3	10	0	0	13	0	0	1	0	1	
Total Volume	0	34	0	0	34	0	0	0	0	0	9	37	0	0	46	5	0	4	0	9	
% App. Total	0	100	0	0		0	0	0	0		19.6	80.4	0	0		55.6	0	44.4	0		
PHF	.000	.654	.000	.000	.654	.000	.000	.000	.000	.000	.750	.841	.000	.000	.821	.417	.000	.500	.000	.563	

# LSC Transportation Consultants, Inc.

545 E Pikes Peak Ave, Suite 210  
Colorado Springs, CO 80905  
719-633-2868

File Name : Falcon Storage PM  
Site Code : S214430  
Start Date : 5/12/2021  
Page No : 5

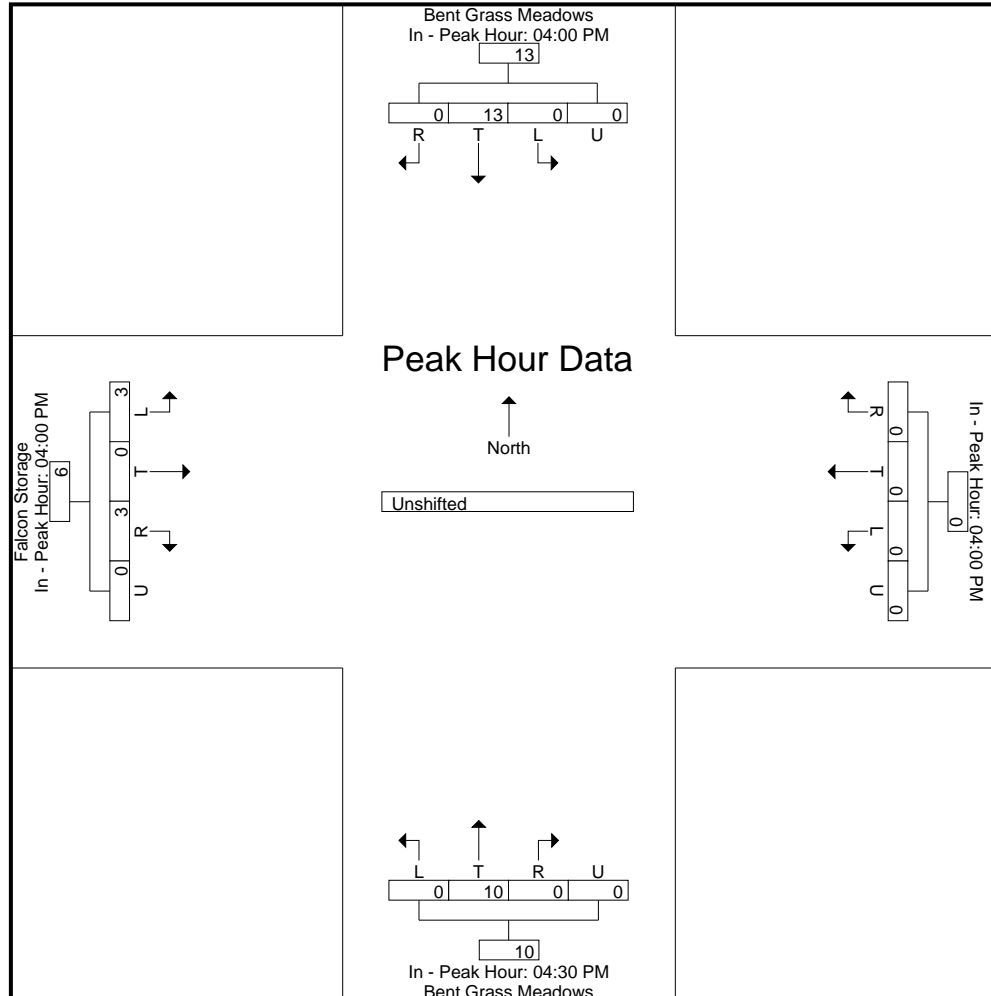

# Levels of Service

---



HCM 6th TWSC  
 1: Woodmen Frontage Rd & Bent Grass Meadows Dr

Existing  
 AM

Intersection						
Int Delay, s/veh	5					
Movement	EBL	EBT	WBT	WBR	SBL	SBR
Lane Configurations		↶	↷		↶	↷
Traffic Vol, veh/h	39	55	92	10	6	139
Future Vol, veh/h	39	55	92	10	6	139
Conflicting Peds, #/hr	0	0	0	0	0	0
Sign Control	Free	Free	Free	Free	Stop	Stop
RT Channelized	-	None	-	None	-	None
Storage Length	-	-	-	-	0	-
Veh in Median Storage, #	-	0	0	-	0	-
Grade, %	-	0	0	-	0	-
Peak Hour Factor	83	83	83	83	83	83
Heavy Vehicles, %	2	2	2	2	2	2
Mvmt Flow	47	66	111	12	7	167

Major/Minor	Major1	Major2	Minor2		
Conflicting Flow All	123	0	-	0	277 117
Stage 1	-	-	-	-	117 -
Stage 2	-	-	-	-	160 -
Critical Hdwy	4.12	-	-	-	6.42 6.22
Critical Hdwy Stg 1	-	-	-	-	5.42 -
Critical Hdwy Stg 2	-	-	-	-	5.42 -
Follow-up Hdwy	2.218	-	-	-	3.518 3.318
Pot Cap-1 Maneuver	1464	-	-	-	713 935
Stage 1	-	-	-	-	908 -
Stage 2	-	-	-	-	869 -
Platoon blocked, %		-	-	-	
Mov Cap-1 Maneuver	1464	-	-	-	689 935
Mov Cap-2 Maneuver	-	-	-	-	689 -
Stage 1	-	-	-	-	878 -
Stage 2	-	-	-	-	869 -

Approach	EB	WB	SB
HCM Control Delay, s	3.1	0	9.8
HCM LOS			A

Minor Lane/Major Mvmt	EBL	EBT	WBT	WBR	SBLn1
Capacity (veh/h)	1464	-	-	-	921
HCM Lane V/C Ratio	0.032	-	-	-	0.19
HCM Control Delay (s)	7.5	0	-	-	9.8
HCM Lane LOS	A	A	-	-	A
HCM 95th %tile Q(veh)	0.1	-	-	-	0.7

HCM 6th TWSC  
2: Bent Grass Meadows Dr & U-Haul Access

Existing  
AM

Intersection						
Int Delay, s/veh	0.3					
Movement	EBL	EBR	NBL	NBT	SBT	SBR
Lane Configurations						
Traffic Vol, veh/h	2	3	2	60	125	2
Future Vol, veh/h	2	3	2	60	125	2
Conflicting Peds, #/hr	0	0	0	0	0	0
Sign Control	Stop	Stop	Free	Free	Free	Free
RT Channelized	-	None	-	None	-	None
Storage Length	0	-	50	-	-	-
Veh in Median Storage, #	0	-	-	0	0	-
Grade, %	0	-	-	0	0	-
Peak Hour Factor	78	78	83	83	83	83
Heavy Vehicles, %	2	2	2	2	2	2
Mvmt Flow	3	4	2	72	151	2

Major/Minor	Minor2	Major1		Major2	
Conflicting Flow All	228	152	153	0	0
Stage 1	152	-	-	-	-
Stage 2	76	-	-	-	-
Critical Hdwy	6.42	6.22	4.12	-	-
Critical Hdwy Stg 1	5.42	-	-	-	-
Critical Hdwy Stg 2	5.42	-	-	-	-
Follow-up Hdwy	3.518	3.318	2.218	-	-
Pot Cap-1 Maneuver	760	894	1428	-	-
Stage 1	876	-	-	-	-
Stage 2	947	-	-	-	-
Platoon blocked, %				-	-
Mov Cap-1 Maneuver	759	894	1428	-	-
Mov Cap-2 Maneuver	758	-	-	-	-
Stage 1	875	-	-	-	-
Stage 2	947	-	-	-	-

Approach	EB	NB	SB
HCM Control Delay, s	9.4	0.2	0
HCM LOS	A		

Minor Lane/Major Mvmt	NBL	NBT	EBLn1	SBT	SBR
Capacity (veh/h)	1428	-	834	-	-
HCM Lane V/C Ratio	0.002	-	0.008	-	-
HCM Control Delay (s)	7.5	-	9.4	-	-
HCM Lane LOS	A	-	A	-	-
HCM 95th %tile Q(veh)	0	-	0	-	-

Intersection						
Int Delay, s/veh	4.6					
Movement	EBL	EBT	WBT	WBR	SBL	SBR
Lane Configurations		↶	↷		↶	↷
Traffic Vol, veh/h	105	71	83	14	9	76
Future Vol, veh/h	105	71	83	14	9	76
Conflicting Peds, #/hr	0	0	0	0	0	0
Sign Control	Free	Free	Free	Free	Stop	Stop
RT Channelized	-	None	-	None	-	None
Storage Length	-	-	-	-	0	-
Veh in Median Storage, #	-	0	0	-	0	-
Grade, %	-	0	0	-	0	-
Peak Hour Factor	87	87	83	83	83	83
Heavy Vehicles, %	2	2	2	2	2	2
Mvmt Flow	121	82	100	17	11	92

Major/Minor	Major1	Major2	Minor2		
Conflicting Flow All	117	0	-	0	433 109
Stage 1	-	-	-	-	109 -
Stage 2	-	-	-	-	324 -
Critical Hdwy	4.12	-	-	-	6.42 6.22
Critical Hdwy Stg 1	-	-	-	-	5.42 -
Critical Hdwy Stg 2	-	-	-	-	5.42 -
Follow-up Hdwy	2.218	-	-	-	3.518 3.318
Pot Cap-1 Maneuver	1471	-	-	-	580 945
Stage 1	-	-	-	-	916 -
Stage 2	-	-	-	-	733 -
Platoon blocked, %		-	-	-	
Mov Cap-1 Maneuver	1471	-	-	-	530 945
Mov Cap-2 Maneuver	-	-	-	-	530 -
Stage 1	-	-	-	-	837 -
Stage 2	-	-	-	-	733 -

Approach	EB	WB	SB
HCM Control Delay, s	4.6	0	9.7
HCM LOS			A

Minor Lane/Major Mvmt	EBL	EBT	WBT	WBR	SBLn1
Capacity (veh/h)	1471	-	-	-	873
HCM Lane V/C Ratio	0.082	-	-	-	0.117
HCM Control Delay (s)	7.7	0	-	-	9.7
HCM Lane LOS	A	A	-	-	A
HCM 95th %tile Q(veh)	0.3	-	-	-	0.4



Intersection						
Int Delay, s/veh	0.6					
Movement	EBL	EBR	NBL	NBT	SBT	SBR
Lane Configurations						
Traffic Vol, veh/h	2	5	9	125	80	2
Future Vol, veh/h	2	5	9	125	80	2
Conflicting Peds, #/hr	0	0	0	0	0	0
Sign Control	Stop	Stop	Free	Free	Free	Free
RT Channelized	-	None	-	None	-	None
Storage Length	0	-	50	-	-	-
Veh in Median Storage, #	0	-	-	0	0	-
Grade, %	0	-	-	0	0	-
Peak Hour Factor	78	78	83	83	83	83
Heavy Vehicles, %	2	2	2	2	2	2
Mvmt Flow	3	6	11	151	96	2

Major/Minor	Minor2	Major1		Major2	
Conflicting Flow All	270	97	98	0	0
Stage 1	97	-	-	-	-
Stage 2	173	-	-	-	-
Critical Hdwy	6.42	6.22	4.12	-	-
Critical Hdwy Stg 1	5.42	-	-	-	-
Critical Hdwy Stg 2	5.42	-	-	-	-
Follow-up Hdwy	3.518	3.318	2.218	-	-
Pot Cap-1 Maneuver	719	959	1495	-	-
Stage 1	927	-	-	-	-
Stage 2	857	-	-	-	-
Platoon blocked, %				-	-
Mov Cap-1 Maneuver	714	959	1495	-	-
Mov Cap-2 Maneuver	729	-	-	-	-
Stage 1	921	-	-	-	-
Stage 2	857	-	-	-	-

Approach	EB	NB	SB
HCM Control Delay, s	9.1	0.5	0
HCM LOS	A		

Minor Lane/Major Mvmt	NBL	NBT	EBLn1	SBT	SBR
Capacity (veh/h)	1495	-	880	-	-
HCM Lane V/C Ratio	0.007	-	0.01	-	-
HCM Control Delay (s)	7.4	-	9.1	-	-
HCM Lane LOS	A	-	A	-	-
HCM 95th %tile Q(veh)	0	-	0	-	-

Intersection						
Int Delay, s/veh	5					
Movement	EBL	EBT	WBT	WBR	SBL	SBR
Lane Configurations						
Traffic Vol, veh/h	39	55	92	10	6	139
Future Vol, veh/h	39	55	92	10	6	139
Conflicting Peds, #/hr	0	0	0	0	0	0
Sign Control	Free	Free	Free	Free	Stop	Stop
RT Channelized	-	None	-	None	-	None
Storage Length	155	-	-	-	0	-
Veh in Median Storage, #	-	0	0	-	0	-
Grade, %	-	0	0	-	0	-
Peak Hour Factor	83	83	83	83	83	83
Heavy Vehicles, %	2	2	2	2	2	2
Mvmt Flow	47	66	111	12	7	167

Major/Minor	Major1	Major2	Minor2		
Conflicting Flow All	123	0	-	0	277 117
Stage 1	-	-	-	-	117 -
Stage 2	-	-	-	-	160 -
Critical Hdwy	4.12	-	-	-	6.42 6.22
Critical Hdwy Stg 1	-	-	-	-	5.42 -
Critical Hdwy Stg 2	-	-	-	-	5.42 -
Follow-up Hdwy	2.218	-	-	-	3.518 3.318
Pot Cap-1 Maneuver	1464	-	-	-	713 935
Stage 1	-	-	-	-	908 -
Stage 2	-	-	-	-	869 -
Platoon blocked, %		-	-	-	
Mov Cap-1 Maneuver	1464	-	-	-	690 935
Mov Cap-2 Maneuver	-	-	-	-	690 -
Stage 1	-	-	-	-	879 -
Stage 2	-	-	-	-	869 -

Approach	EB	WB	SB
HCM Control Delay, s	3.1	0	9.8
HCM LOS			A

Minor Lane/Major Mvmt	EBL	EBT	WBT	WBR	SBLn1
Capacity (veh/h)	1464	-	-	-	921
HCM Lane V/C Ratio	0.032	-	-	-	0.19
HCM Control Delay (s)	7.5	-	-	-	9.8
HCM Lane LOS	A	-	-	-	A
HCM 95th %tile Q(veh)	0.1	-	-	-	0.7

Intersection						
Int Delay, s/veh	0.3					
Movement	EBL	EBR	NBL	NBT	SBT	SBR
Lane Configurations						
Traffic Vol, veh/h	2	3	2	61	125	2
Future Vol, veh/h	2	3	2	61	125	2
Conflicting Peds, #/hr	0	0	0	0	0	0
Sign Control	Stop	Stop	Free	Free	Free	Free
RT Channelized	-	None	-	None	-	None
Storage Length	0	-	50	-	-	-
Veh in Median Storage, #	0	-	-	0	0	-
Grade, %	0	-	-	0	0	-
Peak Hour Factor	78	78	83	83	83	83
Heavy Vehicles, %	2	2	2	2	2	2
Mvmt Flow	3	4	2	73	151	2

Major/Minor	Minor2	Major1	Major2			
Conflicting Flow All	229	152	153	0	-	0
Stage 1	152	-	-	-	-	-
Stage 2	77	-	-	-	-	-
Critical Hdwy	6.42	6.22	4.12	-	-	-
Critical Hdwy Stg 1	5.42	-	-	-	-	-
Critical Hdwy Stg 2	5.42	-	-	-	-	-
Follow-up Hdwy	3.518	3.318	2.218	-	-	-
Pot Cap-1 Maneuver	759	894	1428	-	-	-
Stage 1	876	-	-	-	-	-
Stage 2	946	-	-	-	-	-
Platoon blocked, %				-	-	-
Mov Cap-1 Maneuver	758	894	1428	-	-	-
Mov Cap-2 Maneuver	758	-	-	-	-	-
Stage 1	875	-	-	-	-	-
Stage 2	946	-	-	-	-	-

Approach	EB	NB	SB
HCM Control Delay, s	9.4	0.2	0
HCM LOS	A		

Minor Lane/Major Mvmt	NBL	NBT	EBLn1	SBT	SBR
Capacity (veh/h)	1428	-	834	-	-
HCM Lane V/C Ratio	0.002	-	0.008	-	-
HCM Control Delay (s)	7.5	-	9.4	-	-
HCM Lane LOS	A	-	A	-	-
HCM 95th %tile Q(veh)	0	-	0	-	-

Intersection						
Int Delay, s/veh	0.1					
Movement	EBL	EBR	NBL	NBT	SBT	SBR
Lane Configurations						
Traffic Vol, veh/h	1	1	1	61	127	0
Future Vol, veh/h	1	1	1	61	127	0
Conflicting Peds, #/hr	0	0	0	0	0	0
Sign Control	Stop	Stop	Free	Free	Free	Free
RT Channelized	-	None	-	None	-	None
Storage Length	0	-	50	-	-	-
Veh in Median Storage, #	0	-	-	0	0	-
Grade, %	0	-	-	0	0	-
Peak Hour Factor	78	78	83	83	83	83
Heavy Vehicles, %	2	2	2	2	2	2
Mvmt Flow	1	1	1	73	153	0

Major/Minor	Minor2	Major1		Major2	
Conflicting Flow All	228	153	153	0	0
Stage 1	153	-	-	-	-
Stage 2	75	-	-	-	-
Critical Hdwy	6.42	6.22	4.12	-	-
Critical Hdwy Stg 1	5.42	-	-	-	-
Critical Hdwy Stg 2	5.42	-	-	-	-
Follow-up Hdwy	3.518	3.318	2.218	-	-
Pot Cap-1 Maneuver	760	893	1428	-	-
Stage 1	875	-	-	-	-
Stage 2	948	-	-	-	-
Platoon blocked, %				-	-
Mov Cap-1 Maneuver	759	893	1428	-	-
Mov Cap-2 Maneuver	758	-	-	-	-
Stage 1	874	-	-	-	-
Stage 2	948	-	-	-	-

Approach	EB	NB	SB
HCM Control Delay, s	9.4	0.1	0
HCM LOS	A		

Minor Lane/Major Mvmt	NBL	NBT	EBLn1	SBT	SBR
Capacity (veh/h)	1428	-	820	-	-
HCM Lane V/C Ratio	0.001	-	0.003	-	-
HCM Control Delay (s)	7.5	-	9.4	-	-
HCM Lane LOS	A	-	A	-	-
HCM 95th %tile Q(veh)	0	-	0	-	-

Intersection						
Int Delay, s/veh	4.6					
Movement	EBL	EBT	WBT	WBR	SBL	SBR
Lane Configurations						
Traffic Vol, veh/h	106	71	83	14	9	77
Future Vol, veh/h	106	71	83	14	9	77
Conflicting Peds, #/hr	0	0	0	0	0	0
Sign Control	Free	Free	Free	Free	Stop	Stop
RT Channelized	-	None	-	None	-	None
Storage Length	155	-	-	-	0	-
Veh in Median Storage, #	-	0	0	-	0	-
Grade, %	-	0	0	-	0	-
Peak Hour Factor	87	87	83	83	83	83
Heavy Vehicles, %	2	2	2	2	2	2
Mvmt Flow	122	82	100	17	11	93

Major/Minor	Major1	Major2	Minor2		
Conflicting Flow All	117	0	-	0	435 109
Stage 1	-	-	-	-	109 -
Stage 2	-	-	-	-	326 -
Critical Hdwy	4.12	-	-	-	6.42 6.22
Critical Hdwy Stg 1	-	-	-	-	5.42 -
Critical Hdwy Stg 2	-	-	-	-	5.42 -
Follow-up Hdwy	2.218	-	-	-	3.518 3.318
Pot Cap-1 Maneuver	1471	-	-	-	578 945
Stage 1	-	-	-	-	916 -
Stage 2	-	-	-	-	731 -
Platoon blocked, %		-	-	-	
Mov Cap-1 Maneuver	1471	-	-	-	530 945
Mov Cap-2 Maneuver	-	-	-	-	530 -
Stage 1	-	-	-	-	840 -
Stage 2	-	-	-	-	731 -

Approach	EB	WB	SB
HCM Control Delay, s	4.6	0	9.7
HCM LOS			A

Minor Lane/Major Mvmt	EBL	EBT	WBT	WBR	SBLn1
Capacity (veh/h)	1471	-	-	-	873
HCM Lane V/C Ratio	0.083	-	-	-	0.119
HCM Control Delay (s)	7.7	-	-	-	9.7
HCM Lane LOS	A	-	-	-	A
HCM 95th %tile Q(veh)	0.3	-	-	-	0.4

Intersection						
Int Delay, s/veh	0.6					
Movement	EBL	EBR	NBL	NBT	SBT	SBR
Lane Configurations						
Traffic Vol, veh/h	2	5	9	126	81	2
Future Vol, veh/h	2	5	9	126	81	2
Conflicting Peds, #/hr	0	0	0	0	0	0
Sign Control	Stop	Stop	Free	Free	Free	Free
RT Channelized	-	None	-	None	-	None
Storage Length	0	-	50	-	-	-
Veh in Median Storage, #	0	-	-	0	0	-
Grade, %	0	-	-	0	0	-
Peak Hour Factor	78	78	83	83	83	83
Heavy Vehicles, %	2	2	2	2	2	2
Mvmt Flow	3	6	11	152	98	2

Major/Minor	Minor2	Major1		Major2	
Conflicting Flow All	273	99	100	0	0
Stage 1	99	-	-	-	-
Stage 2	174	-	-	-	-
Critical Hdwy	6.42	6.22	4.12	-	-
Critical Hdwy Stg 1	5.42	-	-	-	-
Critical Hdwy Stg 2	5.42	-	-	-	-
Follow-up Hdwy	3.518	3.318	2.218	-	-
Pot Cap-1 Maneuver	716	957	1493	-	-
Stage 1	925	-	-	-	-
Stage 2	856	-	-	-	-
Platoon blocked, %				-	-
Mov Cap-1 Maneuver	711	957	1493	-	-
Mov Cap-2 Maneuver	727	-	-	-	-
Stage 1	919	-	-	-	-
Stage 2	856	-	-	-	-

Approach	EB	NB	SB
HCM Control Delay, s	9.1	0.5	0
HCM LOS	A		

Minor Lane/Major Mvmt	NBL	NBT	EBLn1	SBT	SBR
Capacity (veh/h)	1493	-	878	-	-
HCM Lane V/C Ratio	0.007	-	0.01	-	-
HCM Control Delay (s)	7.4	-	9.1	-	-
HCM Lane LOS	A	-	A	-	-
HCM 95th %tile Q(veh)	0	-	0	-	-

Intersection						
Int Delay, s/veh	0.2					
Movement	EBL	EBR	NBL	NBT	SBT	SBR
Lane Configurations						
Traffic Vol, veh/h	2	1	2	126	82	1
Future Vol, veh/h	2	1	2	126	82	1
Conflicting Peds, #/hr	0	0	0	0	0	0
Sign Control	Stop	Stop	Free	Free	Free	Free
RT Channelized	-	None	-	None	-	None
Storage Length	0	-	50	-	-	-
Veh in Median Storage, #	0	-	-	0	0	-
Grade, %	0	-	-	0	0	-
Peak Hour Factor	78	78	83	83	83	83
Heavy Vehicles, %	2	2	2	2	2	2
Mvmt Flow	3	1	2	152	99	1

Major/Minor	Minor2	Major1	Major2			
Conflicting Flow All	256	100	100	0	-	0
Stage 1	100	-	-	-	-	-
Stage 2	156	-	-	-	-	-
Critical Hdwy	6.42	6.22	4.12	-	-	-
Critical Hdwy Stg 1	5.42	-	-	-	-	-
Critical Hdwy Stg 2	5.42	-	-	-	-	-
Follow-up Hdwy	3.518	3.318	2.218	-	-	-
Pot Cap-1 Maneuver	733	956	1493	-	-	-
Stage 1	924	-	-	-	-	-
Stage 2	872	-	-	-	-	-
Platoon blocked, %				-	-	-
Mov Cap-1 Maneuver	732	956	1493	-	-	-
Mov Cap-2 Maneuver	742	-	-	-	-	-
Stage 1	923	-	-	-	-	-
Stage 2	872	-	-	-	-	-

Approach	EB	NB	SB
HCM Control Delay, s	9.5	0.1	0
HCM LOS	A		

Minor Lane/Major Mvmt	NBL	NBT	EBLn1	SBT	SBR
Capacity (veh/h)	1493	-	802	-	-
HCM Lane V/C Ratio	0.002	-	0.005	-	-
HCM Control Delay (s)	7.4	-	9.5	-	-
HCM Lane LOS	A	-	A	-	-
HCM 95th %tile Q(veh)	0	-	0	-	-

Intersection						
Int Delay, s/veh	4.8					
Movement	EBL	EBT	WBT	WBR	SBL	SBR
Lane Configurations	↙	↑	↗		↘	
Traffic Vol, veh/h	100	250	150	20	25	200
Future Vol, veh/h	100	250	150	20	25	200
Conflicting Peds, #/hr	0	0	0	0	0	0
Sign Control	Free	Free	Free	Free	Stop	Stop
RT Channelized	-	None	-	None	-	None
Storage Length	155	-	-	-	0	-
Veh in Median Storage, #	-	0	0	-	0	-
Grade, %	-	0	0	-	0	-
Peak Hour Factor	92	92	87	87	87	87
Heavy Vehicles, %	2	2	2	2	2	2
Mvmt Flow	109	272	172	23	29	230

Major/Minor	Major1	Major2	Minor2		
Conflicting Flow All	195	0	-	0	674 184
Stage 1	-	-	-	-	184 -
Stage 2	-	-	-	-	490 -
Critical Hdwy	4.12	-	-	-	6.42 6.22
Critical Hdwy Stg 1	-	-	-	-	5.42 -
Critical Hdwy Stg 2	-	-	-	-	5.42 -
Follow-up Hdwy	2.218	-	-	-	3.518 3.318
Pot Cap-1 Maneuver	1378	-	-	-	420 858
Stage 1	-	-	-	-	848 -
Stage 2	-	-	-	-	616 -
Platoon blocked, %		-	-	-	
Mov Cap-1 Maneuver	1378	-	-	-	387 858
Mov Cap-2 Maneuver	-	-	-	-	387 -
Stage 1	-	-	-	-	781 -
Stage 2	-	-	-	-	616 -

Approach	EB	WB	SB
HCM Control Delay, s	2.2	0	12.2
HCM LOS			B

Minor Lane/Major Mvmt	EBL	EBT	WBT	WBR	SBLn1
Capacity (veh/h)	1378	-	-	-	756
HCM Lane V/C Ratio	0.079	-	-	-	0.342
HCM Control Delay (s)	7.8	-	-	-	12.2
HCM Lane LOS	A	-	-	-	B
HCM 95th %tile Q(veh)	0.3	-	-	-	1.5



Intersection						
Int Delay, s/veh	0.2					
Movement	EBL	EBR	NBL	NBT	SBT	SBR
Lane Configurations						
Traffic Vol, veh/h	2	3	2	125	200	2
Future Vol, veh/h	2	3	2	125	200	2
Conflicting Peds, #/hr	0	0	0	0	0	0
Sign Control	Stop	Stop	Free	Free	Free	Free
RT Channelized	-	None	-	None	-	None
Storage Length	0	-	50	-	-	-
Veh in Median Storage, #	0	-	-	0	0	-
Grade, %	0	-	-	0	0	-
Peak Hour Factor	78	78	83	83	87	87
Heavy Vehicles, %	2	2	2	2	2	2
Mvmt Flow	3	4	2	151	230	2

Major/Minor	Minor2	Major1	Major2			
Conflicting Flow All	386	231	232	0	-	0
Stage 1	231	-	-	-	-	-
Stage 2	155	-	-	-	-	-
Critical Hdwy	6.42	6.22	4.12	-	-	-
Critical Hdwy Stg 1	5.42	-	-	-	-	-
Critical Hdwy Stg 2	5.42	-	-	-	-	-
Follow-up Hdwy	3.518	3.318	2.218	-	-	-
Pot Cap-1 Maneuver	617	808	1336	-	-	-
Stage 1	807	-	-	-	-	-
Stage 2	873	-	-	-	-	-
Platoon blocked, %				-	-	-
Mov Cap-1 Maneuver	616	808	1336	-	-	-
Mov Cap-2 Maneuver	662	-	-	-	-	-
Stage 1	806	-	-	-	-	-
Stage 2	873	-	-	-	-	-

Approach	EB	NB	SB
HCM Control Delay, s	9.9	0.1	0
HCM LOS	A		

Minor Lane/Major Mvmt	NBL	NBT	EBLn1	SBT	SBR
Capacity (veh/h)	1336	-	742	-	-
HCM Lane V/C Ratio	0.002	-	0.009	-	-
HCM Control Delay (s)	7.7	-	9.9	-	-
HCM Lane LOS	A	-	A	-	-
HCM 95th %tile Q(veh)	0	-	0	-	-

Intersection						
Int Delay, s/veh	5.1					
Movement	EBL	EBT	WBT	WBR	SBL	SBR
Lane Configurations	↙	↑	↘		↙	
Traffic Vol, veh/h	200	200	250	50	15	170
Future Vol, veh/h	200	200	250	50	15	170
Conflicting Peds, #/hr	0	0	0	0	0	0
Sign Control	Free	Free	Free	Free	Stop	Stop
RT Channelized	-	None	-	None	-	None
Storage Length	155	-	-	-	0	-
Veh in Median Storage, #	-	0	0	-	0	-
Grade, %	-	0	0	-	0	-
Peak Hour Factor	87	87	83	83	83	83
Heavy Vehicles, %	2	2	2	2	2	2
Mvmt Flow	230	230	301	60	18	205

Major/Minor	Major1	Major2	Minor2		
Conflicting Flow All	361	0	-	0	1021 331
Stage 1	-	-	-	-	331 -
Stage 2	-	-	-	-	690 -
Critical Hdwy	4.12	-	-	-	6.42 6.22
Critical Hdwy Stg 1	-	-	-	-	5.42 -
Critical Hdwy Stg 2	-	-	-	-	5.42 -
Follow-up Hdwy	2.218	-	-	-	3.518 3.318
Pot Cap-1 Maneuver	1198	-	-	-	262 711
Stage 1	-	-	-	-	728 -
Stage 2	-	-	-	-	498 -
Platoon blocked, %		-	-	-	
Mov Cap-1 Maneuver	1198	-	-	-	212 711
Mov Cap-2 Maneuver	-	-	-	-	212 -
Stage 1	-	-	-	-	588 -
Stage 2	-	-	-	-	498 -

Approach	EB	WB	SB
HCM Control Delay, s	4.4	0	14.6
HCM LOS			B

Minor Lane/Major Mvmt	EBL	EBT	WBT	WBR	SBLn1
Capacity (veh/h)	1198	-	-	-	597
HCM Lane V/C Ratio	0.192	-	-	-	0.373
HCM Control Delay (s)	8.7	-	-	-	14.6
HCM Lane LOS	A	-	-	-	B
HCM 95th %tile Q(veh)	0.7	-	-	-	1.7

Intersection						
Int Delay, s/veh	0.3					
Movement	EBL	EBR	NBL	NBT	SBT	SBR
Lane Configurations	↔		↔	↑	↑	
Traffic Vol, veh/h	2	5	9	250	175	2
Future Vol, veh/h	2	5	9	250	175	2
Conflicting Peds, #/hr	0	0	0	0	0	0
Sign Control	Stop	Stop	Free	Free	Free	Free
RT Channelized	-	None	-	None	-	None
Storage Length	0	-	50	-	-	-
Veh in Median Storage, #	0	-	-	0	0	-
Grade, %	0	-	-	0	0	-
Peak Hour Factor	78	78	92	92	87	87
Heavy Vehicles, %	2	2	2	2	2	2
Mvmt Flow	3	6	10	272	201	2

Major/Minor	Minor2	Major1	Major2			
Conflicting Flow All	494	202	203	0	-	0
Stage 1	202	-	-	-	-	-
Stage 2	292	-	-	-	-	-
Critical Hdwy	6.42	6.22	4.12	-	-	-
Critical Hdwy Stg 1	5.42	-	-	-	-	-
Critical Hdwy Stg 2	5.42	-	-	-	-	-
Follow-up Hdwy	3.518	3.318	2.218	-	-	-
Pot Cap-1 Maneuver	535	839	1369	-	-	-
Stage 1	832	-	-	-	-	-
Stage 2	758	-	-	-	-	-
Platoon blocked, %				-	-	-
Mov Cap-1 Maneuver	531	839	1369	-	-	-
Mov Cap-2 Maneuver	602	-	-	-	-	-
Stage 1	826	-	-	-	-	-
Stage 2	758	-	-	-	-	-

Approach	EB	NB	SB
HCM Control Delay, s	9.8	0.3	0
HCM LOS	A		

Minor Lane/Major Mvmt	NBL	NBT	EBLn1	SBT	SBR
Capacity (veh/h)	1369	-	754	-	-
HCM Lane V/C Ratio	0.007	-	0.012	-	-
HCM Control Delay (s)	7.6	-	9.8	-	-
HCM Lane LOS	A	-	A	-	-
HCM 95th %tile Q(veh)	0	-	0	-	-

Intersection						
Int Delay, s/veh	4.8					
Movement	EBL	EBT	WBT	WBR	SBL	SBR
Lane Configurations	↘	↑	↗		↘	
Traffic Vol, veh/h	100	250	150	20	25	200
Future Vol, veh/h	100	250	150	20	25	200
Conflicting Peds, #/hr	0	0	0	0	0	0
Sign Control	Free	Free	Free	Free	Stop	Stop
RT Channelized	-	None	-	None	-	None
Storage Length	155	-	-	-	0	-
Veh in Median Storage, #	-	0	0	-	0	-
Grade, %	-	0	0	-	0	-
Peak Hour Factor	92	92	87	87	87	87
Heavy Vehicles, %	2	2	2	2	2	2
Mvmt Flow	109	272	172	23	29	230

Major/Minor	Major1	Major2	Minor2		
Conflicting Flow All	195	0	-	0	674 184
Stage 1	-	-	-	-	184 -
Stage 2	-	-	-	-	490 -
Critical Hdwy	4.12	-	-	-	6.42 6.22
Critical Hdwy Stg 1	-	-	-	-	5.42 -
Critical Hdwy Stg 2	-	-	-	-	5.42 -
Follow-up Hdwy	2.218	-	-	-	3.518 3.318
Pot Cap-1 Maneuver	1378	-	-	-	420 858
Stage 1	-	-	-	-	848 -
Stage 2	-	-	-	-	616 -
Platoon blocked, %		-	-	-	
Mov Cap-1 Maneuver	1378	-	-	-	387 858
Mov Cap-2 Maneuver	-	-	-	-	387 -
Stage 1	-	-	-	-	781 -
Stage 2	-	-	-	-	616 -

Approach	EB	WB	SB
HCM Control Delay, s	2.2	0	12.2
HCM LOS			B

Minor Lane/Major Mvmt	EBL	EBT	WBT	WBR	SBLn1
Capacity (veh/h)	1378	-	-	-	756
HCM Lane V/C Ratio	0.079	-	-	-	0.342
HCM Control Delay (s)	7.8	-	-	-	12.2
HCM Lane LOS	A	-	-	-	B
HCM 95th %tile Q(veh)	0.3	-	-	-	1.5

Intersection						
Int Delay, s/veh	0.2					
Movement	EBL	EBR	NBL	NBT	SBT	SBR
Lane Configurations	↔		↔	↑	↑	
Traffic Vol, veh/h	2	3	2	126	200	2
Future Vol, veh/h	2	3	2	126	200	2
Conflicting Peds, #/hr	0	0	0	0	0	0
Sign Control	Stop	Stop	Free	Free	Free	Free
RT Channelized	-	None	-	None	-	None
Storage Length	0	-	50	-	-	-
Veh in Median Storage, #	0	-	-	0	0	-
Grade, %	0	-	-	0	0	-
Peak Hour Factor	78	78	83	83	87	87
Heavy Vehicles, %	2	2	2	2	2	2
Mvmt Flow	3	4	2	152	230	2

Major/Minor	Minor2	Major1	Major2			
Conflicting Flow All	387	231	232	0	-	0
Stage 1	231	-	-	-	-	-
Stage 2	156	-	-	-	-	-
Critical Hdwy	6.42	6.22	4.12	-	-	-
Critical Hdwy Stg 1	5.42	-	-	-	-	-
Critical Hdwy Stg 2	5.42	-	-	-	-	-
Follow-up Hdwy	3.518	3.318	2.218	-	-	-
Pot Cap-1 Maneuver	616	808	1336	-	-	-
Stage 1	807	-	-	-	-	-
Stage 2	872	-	-	-	-	-
Platoon blocked, %				-	-	-
Mov Cap-1 Maneuver	615	808	1336	-	-	-
Mov Cap-2 Maneuver	661	-	-	-	-	-
Stage 1	806	-	-	-	-	-
Stage 2	872	-	-	-	-	-

Approach	EB	NB	SB
HCM Control Delay, s	9.9	0.1	0
HCM LOS	A		

Minor Lane/Major Mvmt	NBL	NBT	EBLn1	SBT	SBR
Capacity (veh/h)	1336	-	742	-	-
HCM Lane V/C Ratio	0.002	-	0.009	-	-
HCM Control Delay (s)	7.7	-	9.9	-	-
HCM Lane LOS	A	-	A	-	-
HCM 95th %tile Q(veh)	0	-	0	-	-

Intersection						
Int Delay, s/veh	0.1					
Movement	EBL	EBR	NBL	NBT	SBT	SBR
Lane Configurations						
Traffic Vol, veh/h	1	1	1	126	202	0
Future Vol, veh/h	1	1	1	126	202	0
Conflicting Peds, #/hr	0	0	0	0	0	0
Sign Control	Stop	Stop	Free	Free	Free	Free
RT Channelized	-	None	-	None	-	None
Storage Length	0	-	50	-	-	-
Veh in Median Storage, #	0	-	-	0	0	-
Grade, %	0	-	-	0	0	-
Peak Hour Factor	78	78	83	83	87	87
Heavy Vehicles, %	2	2	2	2	2	2
Mvmt Flow	1	1	1	152	232	0

Major/Minor	Minor2	Major1	Major2			
Conflicting Flow All	386	232	232	0	-	0
Stage 1	232	-	-	-	-	-
Stage 2	154	-	-	-	-	-
Critical Hdwy	6.42	6.22	4.12	-	-	-
Critical Hdwy Stg 1	5.42	-	-	-	-	-
Critical Hdwy Stg 2	5.42	-	-	-	-	-
Follow-up Hdwy	3.518	3.318	2.218	-	-	-
Pot Cap-1 Maneuver	617	807	1336	-	-	-
Stage 1	807	-	-	-	-	-
Stage 2	874	-	-	-	-	-
Platoon blocked, %				-	-	-
Mov Cap-1 Maneuver	616	807	1336	-	-	-
Mov Cap-2 Maneuver	662	-	-	-	-	-
Stage 1	806	-	-	-	-	-
Stage 2	874	-	-	-	-	-

Approach	EB	NB	SB
HCM Control Delay, s	10	0.1	0
HCM LOS	B		

Minor Lane/Major Mvmt	NBL	NBT	EBLn1	SBT	SBR
Capacity (veh/h)	1336	-	727	-	-
HCM Lane V/C Ratio	0.001	-	0.004	-	-
HCM Control Delay (s)	7.7	-	10	-	-
HCM Lane LOS	A	-	B	-	-
HCM 95th %tile Q(veh)	0	-	0	-	-

Intersection						
Int Delay, s/veh	4.9					
Movement	EBL	EBT	WBT	WBR	SBL	SBR
Lane Configurations	↘	↑	↗		↘	
Traffic Vol, veh/h	201	200	250	50	15	171
Future Vol, veh/h	201	200	250	50	15	171
Conflicting Peds, #/hr	0	0	0	0	0	0
Sign Control	Free	Free	Free	Free	Stop	Stop
RT Channelized	-	None	-	None	-	None
Storage Length	155	-	-	-	0	-
Veh in Median Storage, #	-	0	0	-	0	-
Grade, %	-	0	0	-	0	-
Peak Hour Factor	92	92	92	92	87	87
Heavy Vehicles, %	2	2	2	2	2	2
Mvmt Flow	218	217	272	54	17	197

Major/Minor	Major1	Major2	Minor2		
Conflicting Flow All	326	0	-	0	952 299
Stage 1	-	-	-	-	299 -
Stage 2	-	-	-	-	653 -
Critical Hdwy	4.12	-	-	-	6.42 6.22
Critical Hdwy Stg 1	-	-	-	-	5.42 -
Critical Hdwy Stg 2	-	-	-	-	5.42 -
Follow-up Hdwy	2.218	-	-	-	3.518 3.318
Pot Cap-1 Maneuver	1234	-	-	-	288 741
Stage 1	-	-	-	-	752 -
Stage 2	-	-	-	-	518 -
Platoon blocked, %		-	-	-	
Mov Cap-1 Maneuver	1234	-	-	-	237 741
Mov Cap-2 Maneuver	-	-	-	-	237 -
Stage 1	-	-	-	-	619 -
Stage 2	-	-	-	-	518 -

Approach	EB	WB	SB
HCM Control Delay, s	4.3	0	13.6
HCM LOS			B

Minor Lane/Major Mvmt	EBL	EBT	WBT	WBR	SBLn1
Capacity (veh/h)	1234	-	-	-	633
HCM Lane V/C Ratio	0.177	-	-	-	0.338
HCM Control Delay (s)	8.5	-	-	-	13.6
HCM Lane LOS	A	-	-	-	B
HCM 95th %tile Q(veh)	0.6	-	-	-	1.5

Intersection						
Int Delay, s/veh	0.3					
Movement	EBL	EBR	NBL	NBT	SBT	SBR
Lane Configurations						
Traffic Vol, veh/h	2	5	9	251	176	2
Future Vol, veh/h	2	5	9	251	176	2
Conflicting Peds, #/hr	0	0	0	0	0	0
Sign Control	Stop	Stop	Free	Free	Free	Free
RT Channelized	-	None	-	None	-	None
Storage Length	0	-	50	-	-	-
Veh in Median Storage, #	0	-	-	0	0	-
Grade, %	0	-	-	0	0	-
Peak Hour Factor	78	78	83	83	83	83
Heavy Vehicles, %	2	2	2	2	2	2
Mvmt Flow	3	6	11	302	212	2

Major/Minor	Minor2	Major1		Major2	
Conflicting Flow All	537	213	214	0	0
Stage 1	213	-	-	-	-
Stage 2	324	-	-	-	-
Critical Hdwy	6.42	6.22	4.12	-	-
Critical Hdwy Stg 1	5.42	-	-	-	-
Critical Hdwy Stg 2	5.42	-	-	-	-
Follow-up Hdwy	3.518	3.318	2.218	-	-
Pot Cap-1 Maneuver	505	827	1356	-	-
Stage 1	823	-	-	-	-
Stage 2	733	-	-	-	-
Platoon blocked, %				-	-
Mov Cap-1 Maneuver	501	827	1356	-	-
Mov Cap-2 Maneuver	579	-	-	-	-
Stage 1	816	-	-	-	-
Stage 2	733	-	-	-	-

Approach	EB	NB	SB
HCM Control Delay, s	9.9	0.3	0
HCM LOS	A		

Minor Lane/Major Mvmt	NBL	NBT	EBLn1	SBT	SBR
Capacity (veh/h)	1356	-	737	-	-
HCM Lane V/C Ratio	0.008	-	0.012	-	-
HCM Control Delay (s)	7.7	-	9.9	-	-
HCM Lane LOS	A	-	A	-	-
HCM 95th %tile Q(veh)	0	-	0	-	-



Intersection						
Int Delay, s/veh	0.1					
Movement	EBL	EBR	NBL	NBT	SBT	SBR
Lane Configurations						
Traffic Vol, veh/h	2	1	2	251	177	1
Future Vol, veh/h	2	1	2	251	177	1
Conflicting Peds, #/hr	0	0	0	0	0	0
Sign Control	Stop	Stop	Free	Free	Free	Free
RT Channelized	-	None	-	None	-	None
Storage Length	0	-	50	-	-	-
Veh in Median Storage, #	0	-	-	0	0	-
Grade, %	0	-	-	0	0	-
Peak Hour Factor	78	78	92	92	87	87
Heavy Vehicles, %	2	2	2	2	2	2
Mvmt Flow	3	1	2	273	203	1

Major/Minor	Minor2	Major1	Major2			
Conflicting Flow All	481	204	204	0	-	0
Stage 1	204	-	-	-	-	-
Stage 2	277	-	-	-	-	-
Critical Hdwy	6.42	6.22	4.12	-	-	-
Critical Hdwy Stg 1	5.42	-	-	-	-	-
Critical Hdwy Stg 2	5.42	-	-	-	-	-
Follow-up Hdwy	3.518	3.318	2.218	-	-	-
Pot Cap-1 Maneuver	544	837	1368	-	-	-
Stage 1	830	-	-	-	-	-
Stage 2	770	-	-	-	-	-
Platoon blocked, %				-	-	-
Mov Cap-1 Maneuver	543	837	1368	-	-	-
Mov Cap-2 Maneuver	611	-	-	-	-	-
Stage 1	829	-	-	-	-	-
Stage 2	770	-	-	-	-	-

Approach	EB	NB	SB
HCM Control Delay, s	10.4	0.1	0
HCM LOS	B		

Minor Lane/Major Mvmt	NBL	NBT	EBLn1	SBT	SBR
Capacity (veh/h)	1368	-	671	-	-
HCM Lane V/C Ratio	0.002	-	0.006	-	-
HCM Control Delay (s)	7.6	-	10.4	-	-
HCM Lane LOS	A	-	B	-	-
HCM 95th %tile Q(veh)	0	-	0	-	-

# AutoTurn Exhibits 1-4

---



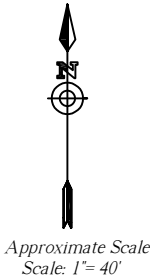

R30.0

R200.0

R35.0

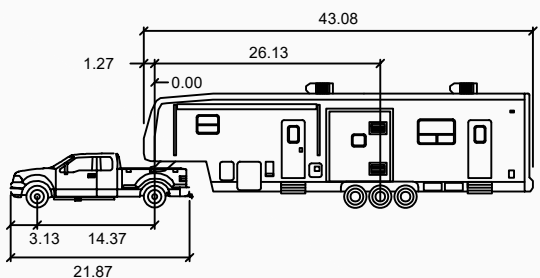

Newmar X-Aire 2009

	feet		
Tractor Width	: 6.66	Lock to Lock Time	: 6.0
Trailer Width	: 8.42	Steering Angle	: 34.2
Tractor Track	: 7.89	Articulating Angle	: 70.0
Trailer Track	: 8.42		

LEGEND:

- ..... = Vehicle Body Clearance (Dot) (1 foot)
- = Vehicle Body
- = Front Tires
- = Rear Tires

Figure 1a

# Inbound AutoTurn Movements

Falcon RV Storage (LSC #214430)

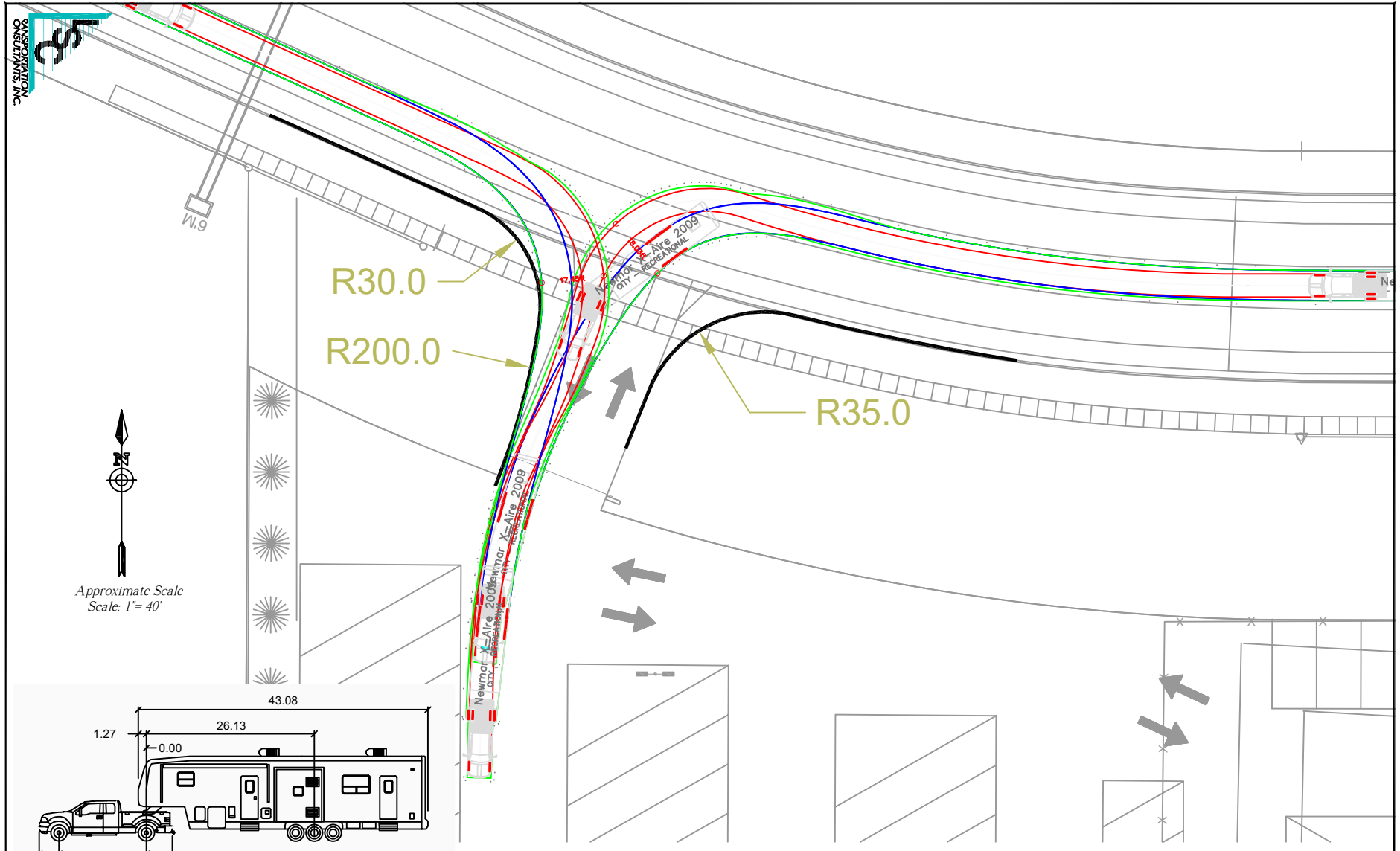

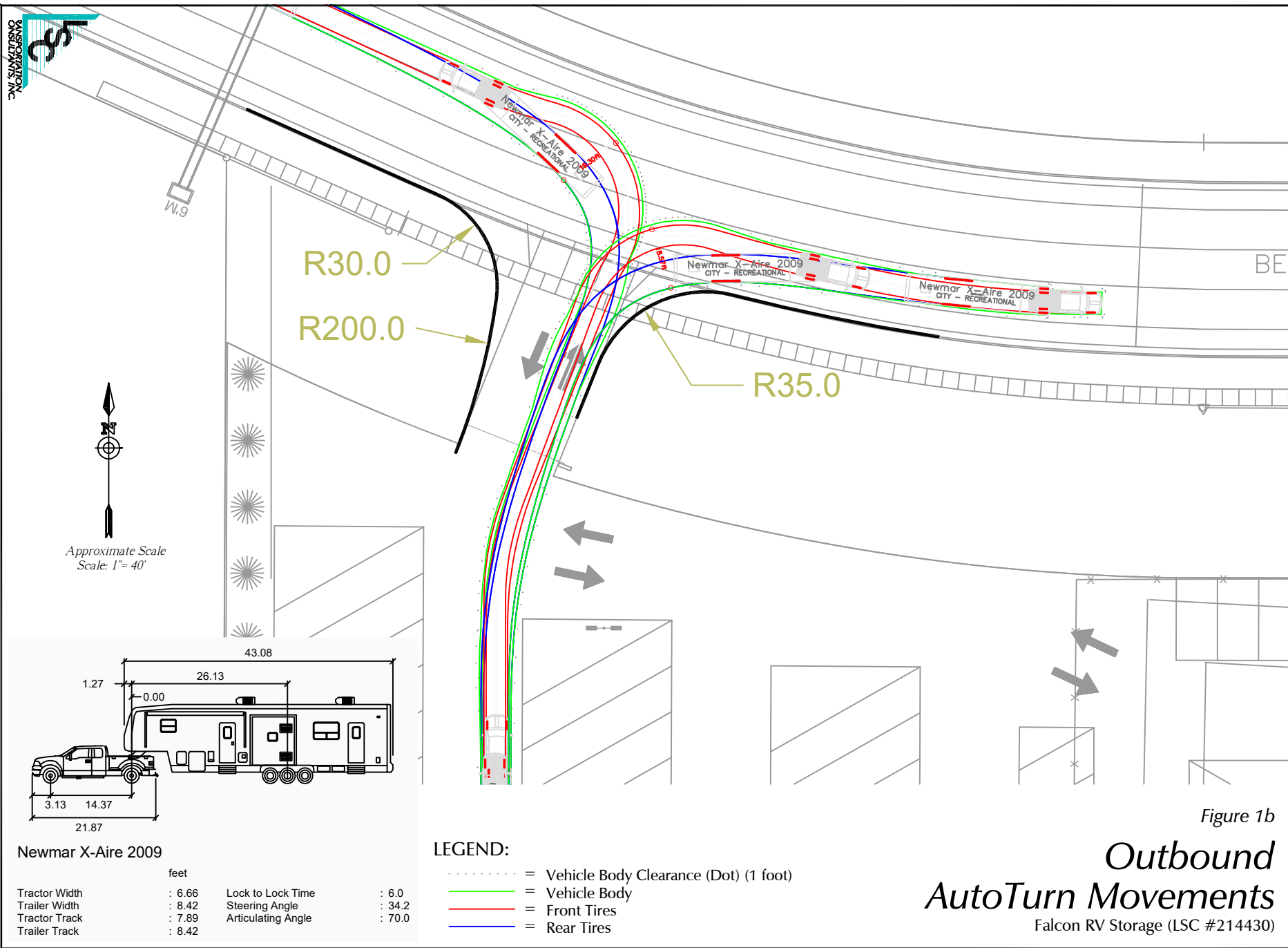

Figure 1b

# Outbound AutoTurn Movements

Falcon RV Storage (LSC #214430)

**Newmar X-Aire 2009**

	feet		
Tractor Width	: 6.66	Lock to Lock Time	: 6.0
Trailer Width	: 8.42	Steering Angle	: 34.2
Tractor Track	: 7.89	Articulating Angle	: 70.0
Trailer Track	: 8.42		

**LEGEND:**

- ..... = Vehicle Body Clearance (Dot) (1 foot)
- = Vehicle Body
- = Front Tires
- = Rear Tires

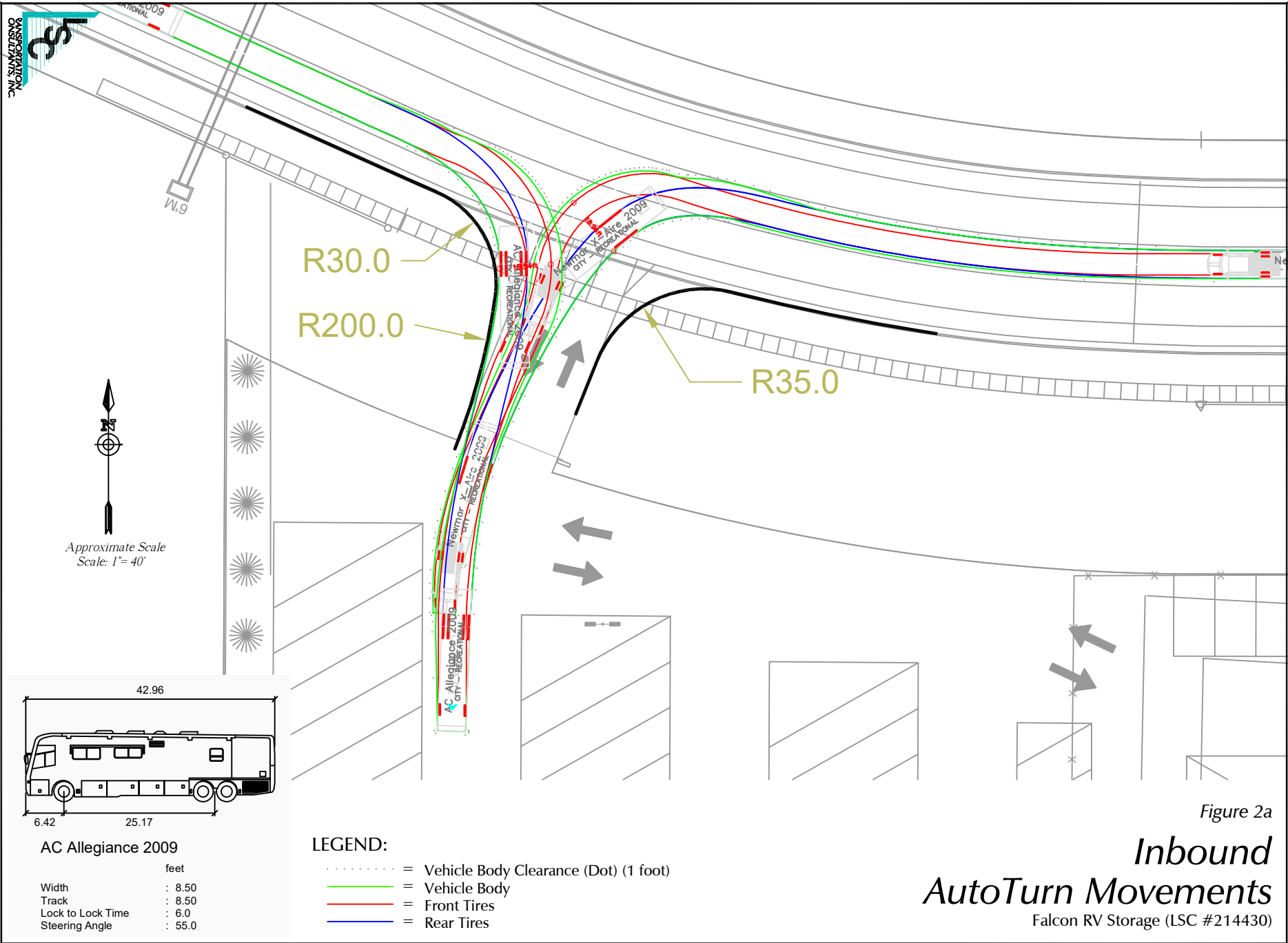
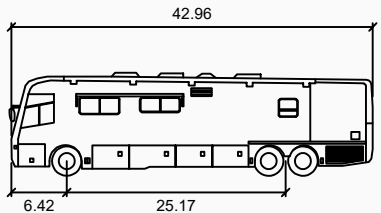
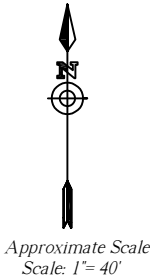

Figure 2a

# Inbound AutoTurn Movements

Falcon RV Storage (LSC #214430)



AC Allegiance 2009

	feet
Width	: 8.50
Track	: 8.50
Lock to Lock Time	: 6.0
Steering Angle	: 55.0

LEGEND:

.....	= Vehicle Body Clearance (Dot) (1 foot)
— (green)	= Vehicle Body
— (red)	= Front Tires
— (blue)	= Rear Tires

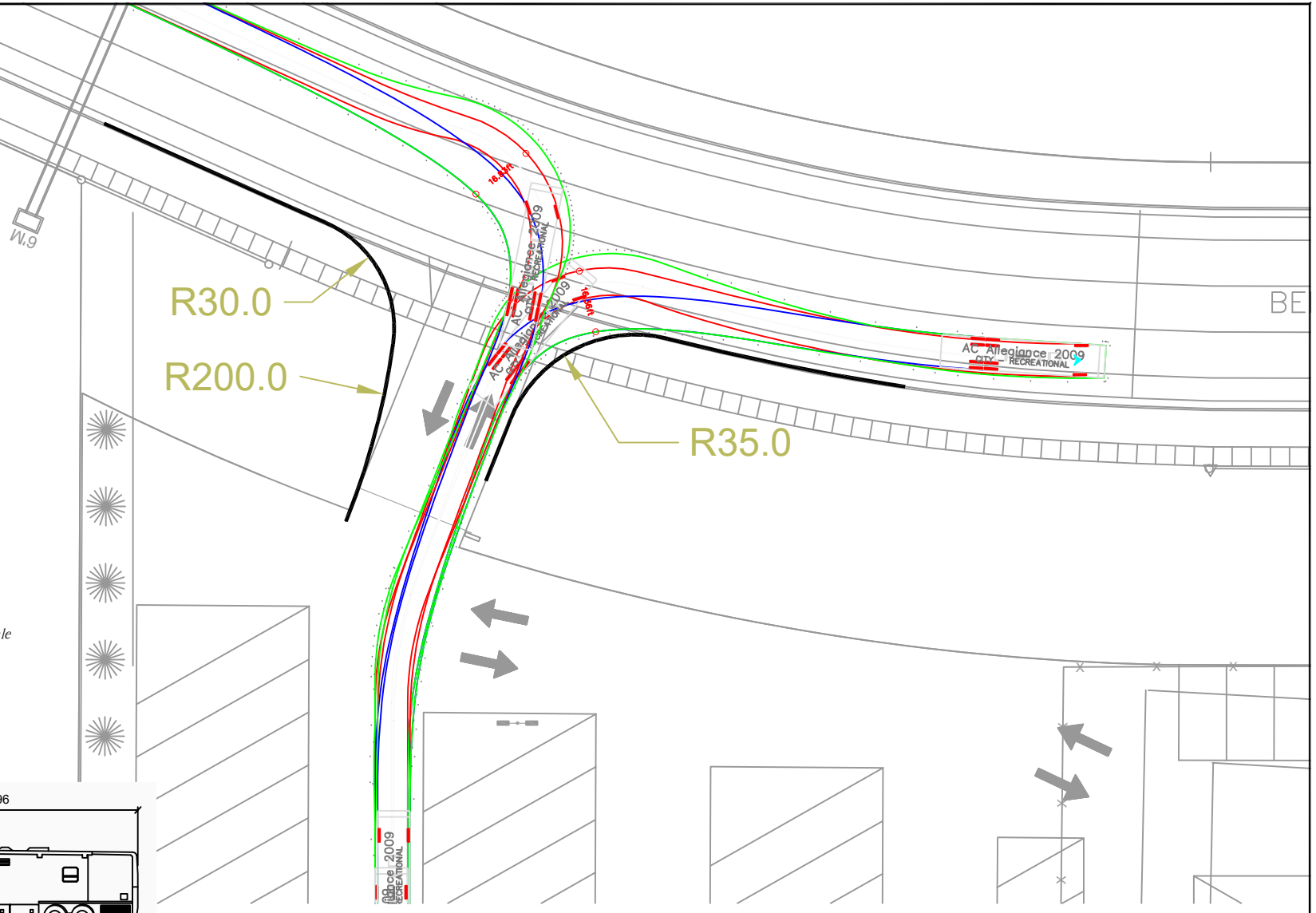

Figure 2b

# Outbound AutoTurn Movements

Falcon RV Storage (LSC #214430)

# Appendix A

---



# Appendix A

## Trip Generation Rate Estimate

### Land Use: RV & Boat Storage

(LSC Revised 6-15-2023)

LSC estimates of trip-generation rates for the proposed RV & Boat Storage land use for this project have been based on averages of rates from other studies summarized in the following table:

ITE Land Use Code	Land Use	Units <sup>1</sup>	Trip Generation Rates				
			Average Weekday	Weekday A.M.		Weekday P.M.	
				In	Out	In	Out
<b><u>RV Storage Trip Generation Report - Valley Park, St. Louis, MO for the RV Storage facility to be located at 802 Forest Avenue by The Traffic Group</u></b>							
-	RV Storage - Data Point 1	100 Storage Units	10.78				
-	RV Storage - Data Point 2	100 Storage Units	10.8				
-	RV Storage - Data Point 3	100 Storage Units	17.23	(duplicate data point)			
<b><u>Trip Generation Analysis for the Proposed Self-Storage and RV Storage Facility at 3701 Pacific Place, Long Beach, California, by LSA Associates</u></b>							
-	RV Storage - Data Point 1	100 Storage Units	17.23	0.50	0.47	0.93	1.12
<b><u>Route 52 RV Traffic Impact Study in Weld County, CO (2017) -- by Sustainable Traffic Solutions, Inc.</u></b>							
-	RV Storage - Data Point 1	100 Storage Units				0.36	0.48
Average Rates			<b>12.94</b>	<b>0.50</b>	<b>0.47</b>	<b>0.65</b>	<b>0.80</b>
Revised JCH 6-15-2023							



LSC estimates of trip-generation rates shown in the table above and used to estimate the trip generation for the proposed RV & Boat Storage land use for this project have been based on averages of rates from the following studies:

**Route 52 RV Traffic Impact Study** 8/28/2017 by Sustainable Traffic Solutions, Inc.

Outdoor RV Storage Trip Generation

Trip Generation Summary

Location	Area (100 Spaces)	Peak Hour Volume					
		Weekday Evening			Sunday Afternoon		
		Total	In	Out	Total	In	Out
Recreational Storage Solutions	6.52	9	3	6	19	9	10
Brighton Outdoor Storage	9.67	5	3	2	36	25	16
<b>Total</b>	<b>16.59</b>	<b>14</b>	<b>6</b>	<b>8</b>	<b>55</b>	<b>29</b>	<b>26</b>
<b>Average</b>	<b>8.30</b>	<b>7</b>	<b>3</b>	<b>4</b>	<b>28</b>	<b>15</b>	<b>13</b>
<b>Percentage</b>	<b>---</b>	<b>100%</b>	<b>43%</b>	<b>57%</b>	<b>100%</b>	<b>52%</b>	<b>47%</b>
<b>Rates (trips/100 spaces)</b>	<b>---</b>	<b>0.84</b>	<b>0.36</b>	<b>0.48</b>	<b>3.32</b>	<b>1.75</b>	<b>1.57</b>

Data Summary

Recreational Storage Solutions				Brighton Outdoor Storage			
Weekday				Weekday			
Interval	In	Out	Total	Interval	In	Out	Total
1	1	2		1	0	0	
2	0	2		2	2	0	
3	2	2		3	0	1	
4	0	0	3	4	0	1	4
5	1	1	8	5	1	0	5
6	1	0	7	6	0	1	4
7	0	1	4	7	1	0	4
8	1	1	5	8	0	1	4
<b>Total</b>	<b>6</b>	<b>9</b>	<b>---</b>	<b>Total</b>	<b>4</b>	<b>4</b>	<b>---</b>
Sunday				Sunday			
Interval	In	Out	Total	Interval	In	Out	Total
1	2	3		1	5	0	
2	2	2		2	5	3	
3	2	2		3	6	6	
4	3	3	19	4	4	7	36
5	1	3	18	5	3	2	36
6	1	2	17	6	4	3	35
7	1	4	18	7	2	2	37
8	4	0	16	8	3	3	22
<b>Total</b>	<b>16</b>	<b>19</b>	<b>---</b>	<b>Total</b>	<b>32</b>	<b>26</b>	<b>---</b>

**Trip-Generation Analysis for the Proposed Self-Storage and RV Storage Facility  
at 3701 Pacific Place, Long Beach, California, 2/27/2020 by LSA Associates**

**Table B: Project Trip Generation (Gate Trip Rates)**

Land Use	Size	Unit	ADT	AM Peak Hour			PM Peak Hour		
				In	Out	Total	In	Out	Total
<b>Trip Rates<sup>1</sup></b>									
Self-Storage		100 storage units	12.90	0.53	0.40	0.93	0.93	0.79	1.72
RV Storage		100 RV spaces	17.23	0.50	0.47	0.97	0.93	1.12	2.05
<b>Project Trip Generation</b>									
Self-Storage	11.00	100 storage units	142	6	4	10	10	9	19
RV Storage	5.80	100 RV spaces	100	3	3	6	5	7	12
<b>Total</b>			<b>242</b>	<b>9</b>	<b>7</b>	<b>16</b>	<b>15</b>	<b>16</b>	<b>31</b>

<sup>1</sup> Trip rates developed from gate data for the Moreno Valley Self Storage and Desert Hot Springs Self Storage and RV Storage facilities (November 2019 to January 2020).

ADT = average daily traffic  
RV = recreational vehicle

**RV Storage Trip Generation Report - Valley Park, St. Louis, MO, for the RV storage  
facility to be located at 802 Forest Avenue 1/6/2022 by The Traffic Group**

Source/Land Use		Daily
<b>ITE -151 (Trip Generation Manual, 11th Ed.)</b>		
Trip Rates	Rate per 100 spaces	17.96
RV Storage	265 RV Spaces	48
<b>Fort Collins - 60% Reduction</b>		
Trip Rates	Rate per 100 spaces	10.78
RV Storage	265 RV Spaces	29
<b>McBride Traffic Study</b>		
Trip Rates	Rate per 100 spaces	10.80
RV Storage	265 RV Spaces	29
<b>Long Beach, CA</b>		
Trip Rates	Rate per 100 spaces	17.23
RV Storage	265 RV Spaces	46
<b>Average Trips for 265 RV Spaces</b>		<b>38</b>

# Site Plan

---



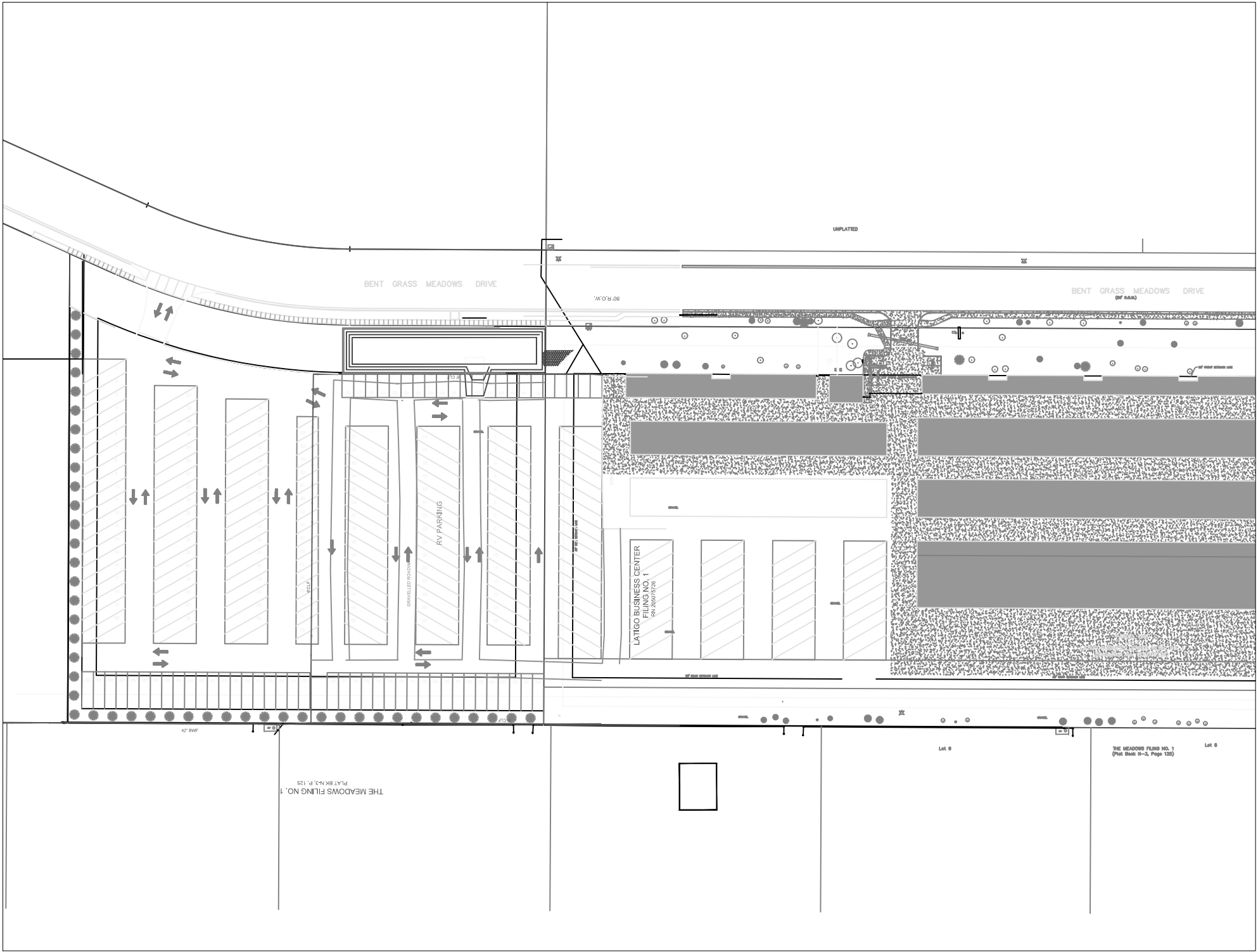

BENT GRASS MEADOWS DRIVE

BENT GRASS MEADOWS DRIVE  
(BY RAK)

W.O.B. 08

UNPLATED

RV PARKING

LATTIGO BUSINESS CENTER  
FILING NO. 1  
RN 2000/9726

THE MEADOWS FILING NO. 1  
PLAT BK M-3, P. 125

Lot 4

THE MEADOWS FILING NO. 1  
(Plat Book M-3, Page 125)

Lot 5