



LSC TRANSPORTATION CONSULTANTS, INC.
2504 East Pikes Peak Avenue, Suite 304
Colorado Springs, CO 80909
(719) 633-2868
FAX (719) 633-5430
E-mail: lsc@lsctrans.com
Website: <http://www.lsctrans.com>

The Commons at Falcon Field – Preliminary Plan
Traffic Impact Study
PCD File No.: SP232
(LSC #S234070)
April 5, 2024

Traffic Engineer's Statement

This traffic report and supporting information were prepared under my responsible charge and they comport with the standard of care. So far as is consistent with the standard of care, said report was prepared in general conformance with the criteria established by the County for traffic reports.

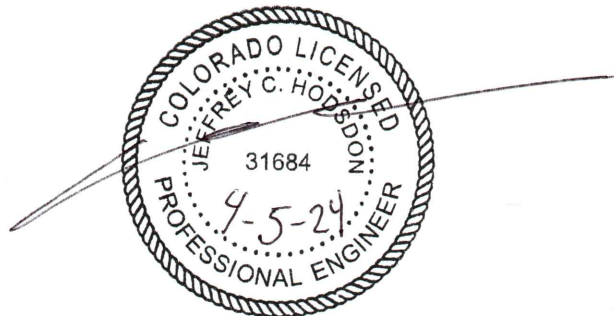

Developer's Statement

I, the Developer, have read and will comply with all commitments made on my behalf within this report.

Date

The Commons at Falcon Field

Traffic Impact Study

PCD File No. SP232

Prepared for:
P.J. Anderson
31 North Tejon, Suite 500
Colorado Springs, CO 80903

APRIL 5, 2024

LSC Transportation Consultants
Prepared by: Jeffrey C. Hodsdon, P.E. & Kirstin D. Ferrin, P.E.

LSC #S234220



CONTENTS

REPORT CONTENTS 1

LIST OF OTHER TRAFFIC REPORTS USED IN THE PREPARATION OF THIS REPORT..... 2

LAND USE And Access 3

 Land Use..... 3

 Access..... 3

 Sight Distance..... 4

PROPOSED RIO LANE CLOSURE AT US HIGHWAY 24 4

EXISTING ROADWAYS AND TRAFFIC VOLUMES..... 5

 Area Roadways..... 5

 Existing Traffic Volumes..... 5

 Existing Levels of Service 6

 Woodmen Road/Meridian Road..... 6

 Woodmen Road/McLaughlin Road..... 6

 Woodmen Road/US Highway 24 7

 US Highway 24/Meridian Road..... 7

 US Highway 24/Rio Lane..... 7

TRIP GENERATION..... 7

 Internal Trips..... 7

 Total External Trip Generation 7

 Pass-by and Diverted Trips 8

 Total External “New” Trip Generation..... 8

 Trip Generation Comparison 8

TRIP DISTRIBUTION 8

 Site-Generated Traffic..... 9

BACKGROUND TRAFFIC VOLUMES 10

 Short Term 10

 Long Term 10

TOTAL TRAFFIC VOLUMES..... 10

LEVEL OF SERVICE ANALYSIS 11

 Woodmen Road/Meridian Road..... 11

 Woodmen Road/McLaughlin Road..... 11

 US Highway 24/Woodmen Road 11

 US Highway 24/Meridian Road..... 12

Woodmen Road/Retail Row Street.....	12
Retail Row Site-Access Points	12
Rio Lane Access Points	13
QUEUING ANALYSIS	13
INTERSECTION AND AUXILIARY TURN LANE RECOMMENDATIONS.....	13
US Highway 24/Woodmen Road	13
Retail Row Intersections	13
Right-In-Only Access Point	13
Roadway Segment Improvements.....	14
Rio Lane.....	14
Retail Row Street	15
Willet Way, Perula Way and Dunlin Drive	15
DEVIATIONS TO ECM CRITERIA.....	15
ROADWAY CLASSIFICATIONS	16
MTCP-IDENTIFIED future needed ROADWAY IMPROVEMENT PROJECTS.....	16
MULTI-MODAL TRANSPORTATION & Transportation Demand Management OPPORTUNITIES .	16
PEDESTRIAN & BICYCLE FACILITIES	16
COUNTY ROAD IMPROVEMENT FEE PROGRAM	17
US HIGHWAY ACCESS MANAGEMENT PLAN AND RIO LANE CLOSURE AT US HIGHWAY 24	17
ROUNDBOUT ANALYSIS & DESIGN	18
CDOT ACCESS PERMITTING.....	19
CONCLUSIONS AND RECOMMENDATIONS.....	19
Trip Generation.....	19
Traffic Operations Analysis	19
Recommended Improvements	19
Enclosures:	21
Tables 2-4	
Figures 1-12	
AutoTurn Exhibits 1-5	
Roundabout Design Parameters Table	
Roundabout Exhibits 1-9	
Traffic Count Reports	
Level of Service Reports	
Queuing Report	

NCHRP Report 684



LSC TRANSPORTATION CONSULTANTS, INC.
2504 East Pikes Peak Avenue, Suite 304
Colorado Springs, CO 80909
(719) 633-2868
FAX (719) 633-5430
E-mail: lsc@lsctrans.com
Website: <http://www.lsctrans.com>

April 5, 2024

P.J. Anderson
31 North Tejon, Suite 500
Colorado Springs, CO 80903

RE: The Commons at Falcon Field
Preliminary Plan
El Paso County, CO
Traffic Impact Study
PCD File No.: [SP232](#)
LSC #S234220

Dear Mr. Anderson,

LSC Transportation Consultants, Inc. has prepared this Traffic Impact Study for the Commons at Falcon Field development in the Falcon area of El Paso County, Colorado. Commons at Falcon Field is a proposed development to be located southeast of the intersection of US Highway 24 (US Hwy 24) and Woodmen Road. This report has been prepared to accompany the resubmittal of the Preliminary Plan application to El Paso County and the Colorado Department of Transportation (CDOT). The Preliminary Plan shows a mix of commercial and residential land uses. LSC previously completed traffic reports for the original rezone, the prior Preliminary Plan, and the 2022 Rezone.

REPORT CONTENTS

The preparation of this report included the following:

- An inventory of existing roadway and traffic conditions on the adjacent and nearby roadway system, including functional classification, widths, pavement markings, surface conditions, traffic, traffic-control signs, posted speed limits, intersection and access spacing, roadway and intersection alignments, roadway grades, and auxiliary turn lanes;
- Weekday peak-hour turning-movement traffic counts at the following intersections:
 - Woodmen Road/US Highway 24
 - Rio Lane/US Highway 24
 - US Highway 24/ Meridian Road
- Estimated current average weekday traffic (AWT) volumes on the study-area streets including US Highway 24, Woodmen Road, Meridian Road, McLaughlin Road, and Rio Lane;

- Projections of 20-year background traffic volumes on the study-area streets;
- The proposed site land uses;
- Estimates of average weekday and weekday peak-hour trip generation for the proposed Falcon Field development and the estimated directional distribution of site-generated vehicle trips on the area street and roadway network;
- Projected site-generated and resulting total peak-hour intersection traffic volumes at the study-area intersections;
- Projected total daily (AWT) volumes on the study-area streets;
- Intersection level of service analysis at the study-area intersections;
- Vehicle queuing and sight-distance analysis at the proposed site-access points;
- Recommended street classifications;
- A list of deviations accompanying this application; and
- Findings and recommendations.

LIST OF OTHER TRAFFIC REPORTS USED IN THE PREPARATION OF THIS REPORT

Prior Falcon Field Traffic Reports for this Site:

- A master TIS report for the original Falcon Field rezone, dated February 24, 2020.
- The TIS report for the previously submitted Preliminary Plan (withdrawn prior to the 2022 rezone), dated November 5, 2020.
- A master TIS report for the 2022 Falcon Field rezone, dated January 21, 2022.

The initial submittal of this report was dated June 23, 2023; Revised (and one new) deviations included with this application were recently resubmitted on February 21, 2024 (EPC PCD File No. [DEV238](#)).

Compared to the TIS for the initial property rezone dated February 24, 2020 (and the TIS for the Preliminary Plan Report dated November 5, 2020), the site trip generation and site-generated traffic based on the currently-proposed zoning is significantly lower than for the strictly commercial zoning that was originally approved. Details are included in the Trip Generation section.

The most recent versions of the following traffic reports were utilized in preparing this report: *Falcon Marketplace (LSC)*, *Meadowlake Ranch (LSC)*, *The Ranch (LSC)*, and the School District 49 Transportation Facility study (LSC), *US Highway 24 Planning and Linkage Study (CDOT)*. This report is generally consistent with these reports. Minor adjustments to background traffic volumes have been made to account for newer traffic counts, and traffic projections in the CDOT PEL study.

LAND USE AND ACCESS

Figure 1 shows the site location relative to the adjacent and nearby roadways. The development is planned to have commercial and residential land uses. The site is directly southeast of the intersection of Woodmen Road/US Highway 24 in Parcels 4307000001 and 4307200015.

Land Use

Commons at Falcon Field is planned to include eight regional commercial lots and 170 single-family residential lots. This report assumes the eight regional commercial lots will be developed with up to 84,000 square feet of general retail floor space. Figure 2a shows the current site plan/Preliminary Plan.

Access

As shown on the site plan, the primary access to the development will be a new southeast leg of the Woodmen Road/US Hwy 24 intersection (currently a T-intersection). This new section of Woodmen Road would be extended southeast to a roundabout intersection with a new Urban Non-Residential Collector, Retail Row Street with a modified cross section. A modified cross section is proposed for this street, which will require approval of a deviation to the criteria contained in The El Paso County *Engineering Criteria Manual (ECM)*. This deviation (No. 5) was recently resubmitted.

The residential development areas are planned to be served by proposed Urban Local streets (that would be public). The commercial lots are planned to be served by private commercial (local) streets. Direct access to the individual commercial lots would be via three private commercial local streets shown on the Preliminary Plan (Willet Way, Perula Way, and Dunlin Drive).

Figure 2b shows the proposed internal public streets and commercial access points/intersections. The proposed spacing of the intersections/access points to Retail Row Street northeast of the proposed roundabout do not meet the prescribed minimum 330-foot spacing required for Urban Non-Residential Collectors, as shown on Table 2-7 of the *ECM*.

A right-in only access is proposed to Woodmen Road. This access will require approval of a deviation from the criteria contained in the *ECM*. This deviation (No. 2a) is included with the set of deviations for the project. .

A street stub to the west is shown on the Preliminary Plan, which would allow for a future connection to future adjacent development if ever needed. The areas within Tracts B and G directly southeast of the proposed roundabout have been reserved to accommodate a potential future fourth leg of the roundabout to provide access to what is currently the northwest corner of Arrowhead Estates IF and when redevelopment happens to occur within that area. Currently,

Figure 3a and 3c has the sight distance analysis along retail row

these possible future connections are not proposed for use by this project. These are being provided for the benefit of US Hwy 24 access management and adjacent property owners, should future connections to adjacent future developments/redevelopment become necessary.

Sight Distance

Figures 3a and 3b show the results of sight-distance analysis of the intersections and access points to Retail Row Street. The analysis is based on a design speed of 25 miles per hour (mph) for the modified cross section. As shown in Figures 3a and 3c, the required intersection sight distance of 280 feet from taken *ECM* Table 2-21 and the required stopping sight distance of 155 feet taken from *ECM* Table 2-17 can be met at all of the proposed intersections and access points to Retail Row Way. One reasonable exception (citing AASHTO criteria) is noted in Figure 3a for sight distance for drivers turning onto Retail Row Street from Willet Way to vehicles traveling southbound to westbound via the Rio Lane/Retail Row Street knuckle located just east of the intersection .

Figure 3b shows the results of the sight distance analysis of the intersection of Woodmen Road/Dunlin Drive. As this access is proposed to be restricted to right-in only, the analysis was limited to stopping sight distance for south-eastbound traffic arriving from the intersection of US Hwy 24/Woodmen. Figure 3c shows the required stopping sight distance based on 40 mph for south-eastbound through vehicles from the intersection of US Hwy 24/Woodmen, based on a 15 mph for north-eastbound right-turning vehicles from the intersection of US Hwy 24/Woodmen, and based on 20 mph for south-westbound left-turning vehicles from the intersection of US Hwy 24/Woodmen. As shown in Figure 3c, the required stopping sight distance can be met for all three scenarios.

This should be 3b

Figure 3d shows the results of sight-distance analysis of the intersections and access points to Rio Lane. The analysis is based on a design speed of 25 miles per hour (mph) for a Local. As shown in Figure 3d, the required intersection sight distance of 280 feet from taken *ECM* Table 2-21 and the required stopping sight distance of 155 feet taken from *ECM* Table 2-17 can be met at all of the proposed intersections and access points to Rio Lane. One reasonable exception (citing AASHTO criteria) is noted in Figure 3d for sight distance for drivers turning onto Rio Lane from Perula Way to vehicles traveling westbound to southbound via the knuckle located just north of the intersection.

see comment

PROPOSED RIO LANE CLOSURE AT US HIGHWAY 24

The intersection of Rio Lane/US Highway 24 is proposed to be closed, as shown in the *US Highway 24 Access Management Plan* and the *US 24 Planning and Environmental Study, October 2017*. The project will help implement the *US Highway 24 Access Management Plan* by providing an alternative to the Rio Lane/US Hwy 24 intersection.

The site plan shows the proposed internal public streets, Retail Row Street and the extension of Woodmen Road into the site, for site circulation and the new connection to Rio Lane that would allow for the prescribed closure of the US Hwy 24/Rio intersection per CDOT's *US Highway 24 Access Management Plan*.

EXISTING ROADWAYS AND TRAFFIC VOLUMES

Area Roadways

The major roadways in the site's vicinity are shown in Figure 1 and are described below.

US Highway 24 is a two-lane, category EX - Expressway/Major Bypass (CDOT Classification) adjacent to the site that runs northeast/southwest with a 55-mile-per hour (mph) posted speed limit adjacent to the site. The corridor was studied in-depth in the *US 24 Planning and Environmental Linkages Study*. CDOT will be completing a US Highway 24 corridor improvement project that will widen the roadway to four lanes from Garrett Road to Woodmen Road. Construction is expected to begin in 2025.

Woodmen Road is a four-lane east/west Expressway that ends at the intersection with US Highway 24. The intersections of Woodmen Road with Meridian Road, McLaughlin Road, and US Highway 24 are all signalized.

Meridian Road is a four-lane north/south Principal Arterial. Meridian Road (the arterial roadway portion) extends north from Falcon Highway to Hodgen Road. Note: the US Hwy 24/Old Meridian Road intersection was converted to a right-in/right-out intersection.

McLaughlin Road is a two-lane, Non-Residential Collector road that extends north from Rolling Thunder Avenue to Eastonville Road. The roadway provides retail and residential access, both north and south of Woodmen Road.

Rio Lane and Rio Road are two-lane Rural Local roadways that connect US Hwy 24 to Falcon Highway. The roadways are about 24 feet wide. The intersection with US Hwy 24 is stop-sign controlled. The intersection with US Hwy 24 is planned to be closed and the new internal roads planned as part of this development will serve as the replacement connection to US Hwy 24.

Existing Traffic Volumes

Figure 4a shows the results of recent morning and afternoon peak-hour turning-movement traffic counts at the intersections of Woodmen Road/US Hwy 24, US Hwy 24/ Meridian Road, US Hwy 24/"Old" Meridian Road, Woodmen/McLaughlin, Woodmen/Meridian and Rio Lane/US Hwy 24. The intersection-traffic counts were collected recently in May 2023.

Existing Levels of Service

Level of service (LOS) is a quantitative measure of the level of delay at an intersection. Level of service is indicated on a scale from “A” to “F.” LOS A represents control delay of less than 10 seconds for unsignalized and signalized intersections. LOS F represents control delay of more than 50 seconds for unsignalized intersections and more than 80 seconds for signalized intersections. Table 1 shows the level of service delay ranges.

Table 1. Intersection Levels of Service Delay Ranges

Level of Service	Signalized Intersections	Unsignalized Intersections
	Average Control Delay (seconds per vehicle)	Average Control Delay (seconds per vehicle) ⁽¹⁾
A	10.0 sec or less	10.0 sec or less
B	10.1-20.0 sec	10.1-15.0 sec
C	20.1-35.0 sec	15.1-25.0 sec
D	35.1-55.0 sec	25.1-35.0 sec
E	55.1-80.0 sec	35.1-50.0 sec
F	80.1 sec or more	50.1 sec or more

(1) For unsignalized intersections, if V/C ratio is greater than 1.0 the level of service is LOS F, regardless of the projected average control delay per vehicle.

Figure 4b presents the results of the existing intersection level of service analysis. The signalized intersections were analyzed using Synchro, while the unsignalized intersection of US Hwy 24/Rio Lane was analyzed based on the unsignalized method of analysis procedures from the *Highway Capacity Manual, 6th Edition* by the Transportation Research Board. The level of service reports are attached.

Woodmen Road/Meridian Road

The signalized intersection of Woodmen/Meridian is currently operating at an overall LOS C during the morning peak hour and an overall LOS D during the afternoon peak hour. Some of the left-turn movements are currently operating at LOS E during the peak hours.

Woodmen Road/McLaughlin Road

The signalized intersection of Woodmen/McLaughlin is currently operating at an overall LOS B during the morning peak hour and an overall LOS C during the afternoon peak hour.

Woodmen Road/US Highway 24

The signalized intersection of Woodmen/US Hwy 24 is currently operating at an overall LOS C during both the morning and afternoon peak hours.

US Highway 24/Meridian Road

The signalized intersection of US Hwy 24/Meridian is currently operating at an overall LOS B during the morning peak hour and an overall LOS D during the afternoon peak hour. During the afternoon peak hour, the existing single northeast-bound left-turn lane is operating at LOS F and the southwest-bound through movement is operating at LOS E.

US Highway 24/Rio Lane

The southwest-bound through/left at the stop-sign-controlled intersection of US Highway 24/Rio Lane currently operates at LOS B or better during the peak hours. The shared northwest-bound left-/right-turning movement on Rio Lane operates at LOS F during the peak hours. The levels of service F for this movement are due both to the volume of left-turning vehicles and the high volume of through vehicles on US Highway 24.

TRIP GENERATION

Estimates of the vehicle trips projected to be generated by the proposed development have been made using the nationally-published trip-generation rates from *Trip Generation, 11th Edition, 2021* by the Institute of Transportation Engineers (ITE). Table 2 (attached) presents the estimated trip generation for The Commons at Falcon Field development.

Internal Trips

Internal trips are trips that occur within a development and do not impact the external roadways. Because the site is planned to have multiple retail pads and housing, some of the generated trips will be traveling within the site. Table 2 includes estimates of internal trip capture to account for trips generated within the site. The internal trips were estimated using the NCHRP 684 Internal Trip Capture Estimation Tool. The results of the tool are attached.

Total External Trip Generation

Approximately 6,825 total external daily trips are projected to enter and exit the site at the access point (“driveway trips”) on the average weekday. During the morning peak hour, approximately 118 vehicles would enter and 142 vehicles would exit the site. During the evening peak, approximately 288 vehicles would enter and 254 vehicles would exit.

Pass-by and Diverted Trips

The trips generated by the commercial portions of the site have also been aggregated by trip type to account for the pass-by phenomenon. A pass-by trip is one made by a motorist who would already be on an adjacent road regardless of the proposed development, but who stops in at the site while passing by. The pass-by motorist would then continue on his or her way to a final destination in the original direction. For purposes of this report, pass-by trips are trips by motorists already traveling through the intersection of US Highway 24/Woodmen Road.

Because the site is near the intersections of US Hwy 24/Falcon Hwy and US Hwy 24/Meridian Road, vehicles traveling through these intersections, but not through the intersection of US Hwy 24/Woodmen Road may still stop at the site on the way to their destination. Because these intersections are not directly adjacent to the site, these trips would be considered “diverted trips”, based on ITE terminology, and therefore are referred to as such in this report. These trips would result in altered turning movements at the nearby major intersections of US Hwy 24/Falcon Hwy, US Hwy 24/Meridian Road, and Woodmen Road/Meridian Road and new turning movements at the intersection of US Hwy 24/Woodmen Road. In addition, it has been assumed that some of these diverted trips coming to and from Falcon Hwy to the east will use Rio Road and Rio Lane to access the site.

Total External “New” Trip Generation

Estimates of Pass-by and diverted trips are shown in Table 2 and are based on *Trip Generation Handbook - An ITE Proposed Recommended Practice*, 3rd Edition, 2014 by ITE. The table shows the resulting external “new” trip generation, which reflects the subtraction of passby trips. Diverted trips are shown as “new” trips, as diverted trips will result in trips added to the Woodmen/US Hwy 24 intersection. Note that many of the diverted trips would not generally represent “new” trips at some off-site intersections – such as US Hwy 24/Meridian and Woodmen/Meridian - although some turning movements would be altered as part of travel route diversions.

Trip Generation Comparison

Table 2 also includes comparison to the estimate presented in the 2022 property rezone TIS, dated December 15, 2021. About 220 fewer daily external vehicle trips are estimated to be generated, based on the currently-proposed site plan, than were assumed in the previous report.

TRIP DISTRIBUTION

An estimate of the directional distribution of site-generated vehicle trips to the study-area roads and intersections is a necessary component in determining the site-generated traffic volumes. Figure 5 shows the directional-distribution estimate for the primary site-generated trips. The figure shows the percentages of the site-generated vehicle trips (primary trips) projected to be

oriented to and from the site's major approaches. Estimates have been based on the following factors: traffic counts conducted at major intersections adjacent to the proposed development, the proposed land uses, the access plan, the area road system serving the site, the site's geographic location, and previously-conducted LSC studies in the vicinity.

The directional-distribution estimates for primary trips are based on the anticipated service area for the retail portion of the development. This commercial center will primarily serve the Falcon area. The higher percentages for Meridian Road north of Woodmen, McLaughlin Road north of Woodmen Road, and US Hwy 24 east of the site reflect the higher current density of "rooftops" and the anticipated growth areas to the north and northeast. The ten-percent split is associated with current residential development and potential future developments to the east (Falcon Highway corridor) and southeast. The five-percent split to/from the southwest on US Hwy 24 (primary trips, like the other directional splits) is intended to account for some future Banning Lewis Ranch connections to US Hwy 24 and potentially some trips from the Cimarron Hills area (likely limited by the longer trip length and availability of retail shops in the Powers Boulevard corridor). The six-percent split to/from west Rolling Thunder Way reflects the residential development in that direction. While the seven-percent split to/from west Woodmen Road accounts for some traffic coming from areas to the west, including northern Colorado Springs, via this route.

Additionally, Figure 5 shows what percentage of overall pass-by and diverted trips have been pulled from each turning movement at the affected intersections to be rerouted as part of the site-generated traffic.

For the residential portion of the development, the directional distribution of the trips is based on residential-oriented destinations during peak hours, such as places of employment, shopping centers, schools, etc. It is anticipated that most trips will travel to/from the west either via Woodmen Road or US Hwy 24, as most retail and employment centers are to the west. Most of the remaining trips are expected to go to/from the north and east via US Hwy 24, McLaughlin Road, and Meridian Road.

Site-Generated Traffic

Site-generated traffic volumes for the development during the weekday morning and evening peak hours are shown in Figure 6 for the following intersections:

- Woodmen Road/US Highway 24
- Woodmen Road/Meridian Road
- Woodmen Road/McLaughlin Road
- US Highway 24/Meridian Road
- US Highway 24/Old Meridian Road
- Internal roundabout
- Internal access points

Site-generated traffic volumes have been calculated by applying the directional-distribution percentages estimated by LSC (from Figure 5) to the trip-generation estimates (from Table 2). The pass-by trips and diverted trips were assigned, based on the magnitude and direction of the peak-hour traffic volumes projected for the major study-area streets/roads.

BACKGROUND TRAFFIC VOLUMES

Background traffic is traffic on the adjacent roadways that is forecast to be present without the proposed development. Short-term and 2044 background traffic scenarios were developed.

Both future forecasts also assume that the intersection of US Hwy 24/Rio Lane has been closed and the associated traffic has been re-routed. Because Rio Lane will no longer directly access US Hwy 24, LSC projects that some of the trips currently using Rio Lane and Rio Road will reroute and use Falcon Hwy or Meridian Road to access US Hwy 24.

Short Term **Figure 7**

Figure 7a shows the estimated short-term background traffic volumes at the study-area intersections. The short-term background volumes assume that the US Hwy 24/Rio Lane intersection has been closed and traffic has been rerouted through the new fourth leg of the US Hwy 24/Woodmen Road intersection.

Long Term

Figure 8 shows the estimated 2044 background traffic volumes. These projected volumes include estimates from planned future Falcon area development and increases in through traffic volumes on the study-area roadways. The 2044 background volumes were developed using the US Highway 24 PEL study. Volumes were modified as needed, based on newer count volumes and expected development in the study area. The 2044 background assumes future commercial development on the parcel to the west of the site with access through the proposed The Commons at Falcon Field development and the internal roundabout.

TOTAL TRAFFIC VOLUMES

Site-generated traffic volumes from Figure 6 were added to short-term background traffic volumes from Figure 7 to calculate short-term total traffic volumes provided in Figure 9. Similarly, 2044 total traffic volumes provided in Figure 10 were calculated by adding the site-generated traffic (Figure 6) with the 2044 background traffic volumes (Figure 8).

LEVEL OF SERVICE ANALYSIS

Levels of service were calculated for both the short-term background, 2044 background, short-term total traffic, and 2044 total traffic volumes. The results of the analysis are shown in Figures 7, 8, 9, and 10. Traffic lanes used in the analysis are also provided in these figures.

Woodmen Road/Meridian Road

The signalized intersection of Woodmen/Meridian is projected to at an overall LOS C during the morning peak hour and an overall LOS D during the afternoon peak hour, based on both the short-term background and total traffic volumes. Some of the left-turn movements are projected to operate at LOS E during the peak hours, based on both the short-term background and total traffic volumes. By 2044, some of the through movements are projected to operate at LOS E and some of the left-turn movements are projected to operate at LOS F, based on both the 2044 background and total traffic volumes.

Woodmen Road/McLaughlin Road

The signalized intersection of Woodmen/McLaughlin is projected to operate at an overall LOS D or better during the morning and afternoon peak hours, based on the short-term background, 2044 background, short-term total, and 2044 total traffic volumes.

US Highway 24/Woodmen Road

In the short-term scenarios, it has been assumed that no baseline capacity improvements (additional northeast-bound/southwest-bound through lanes) will occur on US Hwy 24. However, per recent meetings with CDOT, coordination will continue as this project and the adjacent Highway 24 CDOT project move forward. Cooperation with respect to phasing of improvements, such as potential future use of eastbound right-turn deceleration and acceleration lanes that may be built by this project as future through lanes. The CDOT project would then add new lanes to replace them (for example). The improvements based on the Access Code and CDOT direction provided thus far at the intersection of US Hwy 24/Woodmen Road would include:

- The new fourth northwest bound leg of the intersection with a left lane, two through lanes, and right lane;
- Auxiliary turn lanes on US Hwy 24 to serve the trips/vehicle turning movements associated with the new fourth leg - the development, and the "replacement" Rio Lane connection;
- Raised right-turn islands for pedestrian accessibility;

Review C2: dual lefts
are shown in the figure

Review C3: Unresolved.

- Lane alignment and median modifications on the existing south-east bound leg of the intersection to align with the new fourth leg. Note: The laneage is shown in Figure 11b.
- Signal modifications including installation of any traffic-signal components (including new signal pole(s) on the Woodmen side of the intersection) needed to accommodate the new intersection leg.

Overall, the signalized intersection is forecast to operate at LOS C or better during both peak hours in both the short-term background and short-term total scenarios.

By 2044, it has been assumed that US Hwy 24 will be widened to provide northeast-bound and southwest-bound through lanes per meetings with CDOT regarding the upcoming CDOT Highway 24 project. Overall, the signalized intersection is forecast to operate at LOS D or better during both peak hours in both the 2044 background and 2044 total scenarios.

US Highway 24/Meridian Road

As shown in Figure 4a, the existing northeast-bound left-turn volume at the intersection of US Hwy 24/Meridian is 608 vehicles per hour during the afternoon peak hour. As dual left-turn lanes are typically considered when the left-turn volume exceeds 300 vph, it has been assumed that a second northeast-bound left-turn lane will be constructed in the short term (Potentially, this may be completed as part of the upcoming CDOT Highway 24 project). With the addition of a second turn lane, all movements at this intersection are projected to operate at LOS D or better during the peak hours, based on both the short-term background and short-term total traffic volumes.

By 2044, it has been assumed that US Hwy 24 will be widened to provide northeast-bound and southwest-bound through lanes. Overall, the signalized intersection is forecast to operate at LOS D or better during both peak hours in both the 2044 background and 2044 total scenarios.

Woodmen Road/Retail Row Street

The proposed roundabout at the intersection of Woodmen Road/Retail Row Street has been analyzed using Sidra. The roundabout is expected to have all approaches operate at LOS A during both peak hours, based on the projected short-term and 2044 total traffic volumes.

Retail Row Site-Access Points

The access points to the Retail Row Street have been analyzed as stop-sign-controlled (unsignalized) intersections. All yielding turning movements at the proposed access points are anticipated to operate at LOS C or better through 2044.

Rio Lane Access Points

The proposed intersections of Rio Lane/Perula Lane, Rio Lane/Jacamar Way and Rio Lane/Toddy Way been analyzed as a stop-sign-controlled (unsignalized) intersections. All approaches are projected to operate at LOS B or better during the peak hours, based on the short-term total and 2044 total traffic volumes.

QUEUING ANALYSIS

A queuing analysis was performed using Synchro/SimTraffic for the key approach turning movements at the intersection of US Hwy 24/Woodmen Road and the proposed Retail Row Street access points to determine the projected queue lengths, based on the 2044 total traffic volumes. The simulation was run five times. The queuing reports are attached. These queuing results have been used to develop auxiliary turn-lane recommendations. The results of the analysis are shown in Table 3.

INTERSECTION AND AUXILIARY TURN LANE RECOMMENDATIONS

The El Paso County *Engineering Criteria Manual (ECM)* and the *Colorado State Highway Access Code* standards were used as a basis for the following turn-lane and other recommendations at the intersections.

US Highway 24/Woodmen Road **Figure 11b**

Figure 11a  provides the recommendations for improvements at the intersection of US Highway 24/Woodmen Road, including auxiliary turn-lane dimensions and modifications needed with the new fourth leg of the intersection of US Hwy 24/Woodmen Road.

Retail Row Intersections **Figure 11c**

Figure 11b  shows the recommended turn-lane lengths at the proposed internal intersections/access points to Retail Row Street.

Right-In-Only Access Point

Figures 2a and 2b show the proposed right-in-only access point to Woodmen Road, including the access spacing details. The proposed right-in-only access point would provide a low-impact, low-conflict secondary entry point to the commercial lot areas west of Woodmen.

The proposed right-turn lane would have abbreviated lane and taper lengths. The *ECM* standard is 155-foot lane plus 160-foot taper, plus storage. Figure 11d (a copy of Deviation Exhibit 2a-1 from Deviation 2a) shows the proposed lengths. The lane would be about 130 feet plus a 55-foot

bay taper. The abbreviated length will be mitigated by the proposed 50-foot corner radius. Please refer to Deviation No. 3, which addresses turn lane design.

The assumption is that site plans for specific development served by the proposed right-in-only access point will be designed such that traffic entering via the proposed right-in-only access will have a “free movement” onto internal private-access drives, parking bays, etc., such that queues will not form and back into the right-in access point or the main entry street (Woodmen Road). This would likely be accomplished with a sufficient entry “throat” and other site-plan-level design elements that would give priority to entering traffic. Please refer to the deviation request for the right-in-only access for additional details.

ROADWAY SEGMENT IMPROVEMENTS

Rio Lane

As identified above, Rio Lane and Rio Road are two-lane Rural Local roadways that connect US Hwy 24 to Falcon Highway. The roadways are 24 feet wide and were recently paved.

The project will generate trips using Rio Lane between Falcon Highway and the site, but it is important to note that the daily volume has already reduced with opening of New Meridian Road north of Falcon Highway. Closing the direct Rio Lane connection to US Highway 24, the route used by cut-through traffic will create a significantly more circuitous route and will likely discourage some motorists continue to use Rio Lane as a cut-through route between Falcon Highway and US Highway 24.

The projected net volumes presented in this report are the estimated current volume (1,700 vehicles per day) plus increases due to site-generated traffic **minus** estimated reductions in cut-through traffic and redistribution of area resident traffic (due to the closure of the direct connection of Rio Lane to US Hwy 24). There will be an overall net decrease from the 2021 volume of 2,700 vehicles per day shown in the January 2022 rezone report.

The current roadway cross section will be sufficient for accommodating the resulting net vehicular traffic volumes on Rio Lane and Rio Road. Given the large adjacent lots and driveway lengths, on-street parking, while allowed, is likely infrequent. Widening the drivable pavement width of Rio Road has the potential to encourage higher speeds. Therefore, any future enhancements/upgrades should be for non-motorized use (pedestrians and bicycles) that would fit within the right-of-way. Rio Road has a straight alignment, and the vertical profile is relatively level, which both allow for good sight distance.

Working within the available right-of-way, it may be feasible to add enhancements for pedestrians/bikes by creating segments of north-south gravel, separated pedestrian path combined with segments of widened gravel shoulder. Widened shoulders would provide

additional space for pedestrians, but don't offer physical protection. This project will be installing a sidewalk along the south side of the east-west segment adjacent to the site frontage and on both sides of the street for the section within the site. The project will also provide a street stub to Pinto Pony Road that could be used as a pedestrian collection to Chief Road and Pinto Pony Road.

Other measures to enhance pedestrian safety could potentially include roadway illumination. However, it is not likely practical or desirable to the area residents to improve pedestrian visibility with roadway illumination. Measures to educate and encourage the use of flashing LED lights, retroreflective clothing, vests, armbands etc. by local-residents clothing or armbands should be considered. Signs along the roadway could be placed to remind area residents and other users of the roadway for non-motorized travel, to wear retro-reflective gear.

Retail Row Street

Aside from the extension of Woodmen Road into the site from the US Highway 24 intersection, Retail Row Street will be the main internal street serving the commercial and residential development, it will also provide the replacement Rio Lane connection to US Highway 24.

Retail Row Street is proposed as a Non-Residential Collector with a modified cross-section. Please refer to the Intersection improvements section for intersection recommendations. Please refer to deviation request No. 5 for details regarding the proposed cross section and other planning and design details.

Willet Way, Perula Way and Dunlin Drive

Comments have been provided that the private roadways on the east side (Perula Way) shall meet County standards. Please revise.

Direct access to the individual commercial lots would be via three "private commercial (local)" streets shown on the Preliminary Plan (Willet Way, Perula Way and Dunlin Drive). These streets would be 26-foot wide plus curb and gutter (30-feet of width flowline-to-flowline), with attached 5-foot-wide sidewalks.

DEVIATIONS TO ECM CRITERIA

The following deviations to the criteria contained in the El Paso County *Engineering Criteria Manual (ECM)* have been recently submitted as part of this application:

- Public street intersection spacing along an Urban Non-Residential Collector – Woodmen Road (proposed) southeast of US Highway 24/Retail Row Street
- Right-in-Only access to an Urban Non-Residential Collector
- Full-movement access to an Urban Non-Residential Collector;
- *ECM*-standard auxiliary turn-lane lengths on an Urban Non-Residential Collector.
- Modification to the design standards of an Urban Non-Residential Collector Street (Retail Row Street)

ROADWAY CLASSIFICATIONS

revise to urban local



- The streets proposed for this project would be classified as either Urban Non-Residential Collector or Urban Local or “private commercial (local)” streets. Please refer to Figure 12, which presents the recommended classifications for the proposed streets shown on the Preliminary Plan. The figure also shows the classification of the adjacent existing roadways as described in the “Existing Roadways” section.

MTCP-IDENTIFIED FUTURE NEEDED ROADWAY IMPROVEMENT PROJECTS

- The *El Paso County Major Transportation Corridors Plan (MTCP)* calls for improvement to US Hwy 24 from Garrett Road to Woodmen Road and upgrade to a rural six-lane Principal Arterial. As mentioned in the “Existing Roadways” section above, CDOT will be completing a US Hwy 24 corridor improvement project that will widen the roadway to four lanes from Garrett Road to Woodmen Road. Construction is expected to begin in 2025.
- Although not in the immediate area, the *MTCP* calls for an upgrade to Falcon Highway to a two-lane, rural Minor Arterial from US Hwy 24 to one mile east of Curtis Road. Also, the *MTCP* calls for an upgrade to Eastonville Road from McLaughlin to Latigo Boulevard as a rural road upgrade to a two-lane Rural Minor Arterial.
- The project would need to construct a sidewalk or potentially a multi-use trail, along the north side of Woodmen Road between the US Hwy 24 intersection and the current sidewalk located about 450 feet northwest of US Hwy 24. This point is adjacent to the connection.

MULTI-MODAL TRANSPORTATION & TRANSPORTATION DEMAND MANAGEMENT OPPORTUNITIES

- The following section describes the details of a pedestrian/bicycle connection between this project and the Rock Island Trail.
- Trail connections exist between the Rock Island Trail and the Woodmen Hills neighborhoods to the north of US Highway 24.
- A Park & Ride facility has been developed nearby at the intersection of Meridian Road and Swingline Road. Future Mountain Metropolitan Transit bus service may be added to/from this Park & Ride location.

PEDESTRIAN & BICYCLE FACILITIES

- The project would include urban street sections with sidewalks.
- Figure 11a shows the recommendation for curbed right-turn pedestrian islands. The traffic signal would be modified to provide full pedestrian access on all four legs of the intersection. These details would be shown as part of the traffic-signal modification plan and the intersection-improvement construction drawings. These design details and plans

would be part of the access permit process with CDOT and would need CDOT approval prior to issuance of a NTP (Notice-to-proceed).

- The project would need to construct a sidewalk or potentially a multi-use trail, along the north side of Woodmen Road between the US Highway 24 intersection and the current sidewalk on the north side of Woodmen Road, which currently ends about 450 feet northwest of Highway 24. This point is adjacent to the connection to the Rock Island Trail.
- Improvements to Rio Lane along the site frontage (sidewalk along the south side of the roadway adjacent to the site and on both sides of the street for the section within the site (development on both sides).
- "Rio Road"
- School Pedestrian Routes
 - School pedestrian connection to Falcon Elementary School: Potentially, a pedestrian connection could be implemented to connect to the northeast corner of the school district property, along with a pedestrian path to the school on the school district property. However, about 140' of private property lies between the southeast corner of this project and the northeast corner of the school district property.
 - If the above plan is not workable, the Preliminary Plan shows pedestrian connections to Rio Lane and Pinto Pony Road. Pinto Pony Road connects to Chief Road, which extends south to Falcon Highway. Pinto Pony Road and Chief Road are low volume, rural gravel roadways. Consideration could be given to providing a gravel-surface, pedestrian path/trail, with sufficient separation from the edge of the roadway along the north side of Falcon Highway between Chief Road and the school. Note: currently, there are almost no pedestrian facilities within the school district property and no sidewalks along Falcon Highway.

COUNTY ROAD IMPROVEMENT FEE PROGRAM

- This project is subject to participation in the County Roadway Improvement Fee Program.

US HIGHWAY ACCESS MANAGEMENT PLAN AND RIO LANE CLOSURE AT US HIGHWAY 24

- This project will implement part of the *US Highway Access Management Plan*. The intersection of Rio Lane/US Highway 24 is proposed to be closed, as shown in the adopted *US Highway 24 Access Management Plan* and the *US 24 Planning and Environmental Linkages Study*, October 2017. The project will help implement the *US Highway 24 Access Management Plan* by providing an alternative to the Rio Lane/US Highway 24 intersection.
- The site plan shows the proposed internal public streets for site circulation and the new connection to Rio Lane that would allow for the prescribed closure of the US Highway 24/Rio intersection, per CDOT's *US Highway 24 Access Management Plan*.
- This will benefit safety and traffic operations on US Highway 24. The existing Rio Lane/US Highway 24 intersection is substandard, as there are no left- and right-turn

lanes. The level of service during the peak hour is LOS F (96 seconds of delay per vehicle on average for vehicles wanting to turn onto US Highway 24).

- The project will generate trips using Rio Lane and Rio Road between Falcon Highway and the site, but it is important to note that by closing the direct Rio Lane connection to US Highway 24, the route used by cut-through traffic will be significantly more circuitous and will likely discourage motorists who currently use Rio Lane and Rio Road as a cut-through route to Falcon Highway.
- The recently completed Meridian Road extension south of Rolling Thunder, across US Highway 24 to Falcon Highway has improved the roadway connectivity to Falcon Highway (and traffic volumes show a resulting reduction in volume on Rio Lane and Rio Road).
- The County has indicated that they will require upgrades to Rio Lane and Rio Road, necessary to accommodate the resulting net traffic volumes on Rio Lane and Rio Road between Falcon Highway and the site. The details of recommended upgrades are included in the section above.
- The project will add a signal-controlled connection to US Highway 24 and Woodmen – not only for this development but also for the benefit of the residents in Falcon Ranch Estates and Arrowhead Estates Filing No. 1. This connection will have left- and right-turn lanes on US Highway 24.
- The proposed roundabout is proposed to be constructed as a T-intersection (no south leg). However, a fourth (south) leg could be added in the future if/when adjacent property(ies) southeast of The Commons at Falcon Field redevelop in the future. The applicant will reserve land southeast of the roundabout as right-of-way preservation for a potential future extension to the adjacent property, if ever needed.

ROUNDAABOUT ANALYSIS & DESIGN

A modern roundabout with a 180-foot inscribed circle diameter is proposed as the traffic control for the intersection of Woodmen Road/ Retail Row Street. Roundabout exhibits containing roundabout technical analysis are attached, along with a roundabout parameters table.

The horizontal layout and analysis exhibits have been completed using the criteria contained in the Wisconsin Department of Transportation roundabout design manual (as required by El Paso County). The attached roundabout exhibits and roundabout parameters table contain all the details for the currently proposed roundabout. The inscribed circle diameter is 180 feet and the design vehicles are a WB-50 truck and an El Paso County standard snowplow vehicle (per the *ECM*). However, the roundabout has also been designed to accommodate a larger WB-67 truck. The roundabout will also accommodate the standard county snowplow vehicle. The roundabout will accommodate pedestrians and bicyclists. Please refer to the attached roundabout-parameters table and exhibits for details. The final roundabout design report will be submitted following the review and County staff acceptance of the horizontal layout shown on attached exhibits.

Review C2: values does not match the trip gen table #3. revise.
Review C3: Unresolved. It is 3594 in table 2.

CDOT ACCESS PERMITTING

CDOT access permits will be required for the street connection to the US Highway 24/Woodmen Road intersection and for the closure of Rio Lane at US Highway 24. Per recent meetings with CDOT, coordination will continue as this project and the adjacent Highway 24 CDOT project move forward.

CONCLUSIONS AND RECOMMENDATIONS

Trip Generation

- The Commons at Falcon Field is expected to generate about 3,592 new external vehicle trips on the average weekday, with about half entering and half exiting the site during a 24-hour period. During the morning peak hour, about 118 vehicles would enter and 142 vehicles would exit the site. During the afternoon peak hour, approximately 288 vehicles would enter and 254 vehicles would exit the site.

Traffic Operations Analysis

- The signalized intersection of US Highway 24/Woodmen Road is projected to operate at LOS D or better during both peak hours for the short-term and year-2044 scenarios. The El Paso County *Engineering Criteria Manual (ECM)* standards were followed to develop turn-lane recommendations at the intersections. Figure 11a provides the turn-lane conceptual design for this intersection. Please refer to the Level of Service and Queuing Analysis sections of this report for additional details and discussion.

Recommended Improvements

- A list of recommended improvements within the site and in the study area is presented in Table 4.
- The intersection of US Highway 24/Rio Lane is to be closed and the proposed Collector roads within the site will connect Rio Lane to the US Highway 24/Woodmen intersection.

Short-term improvements assumed at the intersection of US 24/Woodmen Road would include:

- The fourth leg of the intersection with a northwest-bound left-lane, two northwest-bound through-lanes, and northwest-bound right-lane as shown in Figure 11a;
- Raised right-turn islands for pedestrian accessibility;
- Lane alignment and median modifications on the existing northwest of the intersection as shown in Figure 12a;
- Signal modifications including installation of traffic-signal components needed for the new leg; and

11b

- Auxiliary turn lanes on US Highway 24 to serve the trips/vehicle turning movements associated with the new fourth leg of this intersection. This new fourth leg would serve site traffic and background traffic shifted from the closure of the US Highway 24/ Rio Lane connection.

Based on the 2044 total traffic volumes shown in Figure 10 and the criteria contained in the *State of Colorado Highway Access Code*, the following deceleration and acceleration lanes are required on US Highway 24:

- A northeast-bound right-turn deceleration lane is warranted on US Highway 24 approaching Woodmen Road. Based on a posted speed limit of 55 mph, the prescribed lane length for the deceleration lane is 600 feet plus a 222-foot taper.
- A southwest-bound left-turn deceleration lane is warranted on US Highway 24 approaching Woodmen Road. Based on a posted speed limit of 55 mph, the prescribed lane length for the deceleration lane is 600 feet plus 100 feet of storage and a 222-foot taper.
- A northwest-bound right-turn acceleration lane is warranted on US Highway 24 east of Woodmen Road. Based on a posted speed limit of 55 mph, the prescribed lane length for the acceleration lane is 960 feet plus a 222-foot taper.

Based on the 2044 total traffic volumes shown in Figure 10 and the criteria contained in the *ECM*, the following deceleration and acceleration lanes are required on Retail Row Street:

- A southwest-bound left-turn lane is warranted on Retail Row Street approaching Nunbird Court. Based on a design speed limit of 25 mph, the *ECM*-required lane length would be 115 feet for deceleration, 50 to 75 feet for storage, and a 80-foot taper. Based on the available lane length and the 95th percentile queue length analysis results shown in Figure 11, LSC recommends a 100-foot left-turn lane plus 65-foot reverse curve bay taper.
- A northeast-bound left-turn lane is not projected to be warranted on Retail Row Street approaching Dunlin Drive. However, this lane will be needed to align with the recommended left-turn lane approaching Nunbird Court. Based on a design speed limit of 25 mph, the *ECM*-required lane length would be 115 feet for deceleration, 50 to 75 feet for storage, and an 80-foot taper. Based on the available lane length and the 95th percentile queue length analysis results shown in Table 3, LSC recommends a 165-foot left-turn lane plus 80-foot taper.
- A northeast-bound left-turn lane is projected to be warranted on Retail Row Street approaching Willet Way. Based on a design speed limit of 25 mph, the *ECM*-required lane length would be 115 feet for deceleration, 100 feet for storage, and a 80-foot taper. Based on the available lane length and the 95th percentile queue length analysis results shown in Table 3, LSC recommends a 120-foot left-turn lane plus a 50 to 75-foot reverse curve bay taper.

Please provide
figure 11.

Please contact me if you have any questions regarding this report.

Sincerely,

LSC TRANSPORTATION CONSULTANTS, INC.

By: Jeffrey C. Hodsdon, P.E.
Principal

JCH/KDF/JAB:jas

Enclosures: Tables 2-4
Figures 1-12
AutoTurn Exhibits 1-5
Roundabout Design Parameters Table
Roundabout Exhibits 1-9
Traffic Count Reports
Level of Service Reports
Queuing Report
NCHRP Report 684

References:

Trip Generation Handbook - An ITE Proposed Recommended Practice, Third Edition September 2017, Institute of Transportation Engineers
Trip Generation, 10th Edition, 2017, Institute of Transportation Engineers
El Paso County Major Transportation Corridors Plan, 2016
Engineering Criteria Manual, 2016, El Paso County
NCHRP Report 684 Enhancing Internal Trip Capture Estimation for Mixed-Use Developments, 2011, Transportation Research Board
State Highway Access Code, Volume Two, 2002, Colorado Department of Transportation
US 24 Access Control Plan, 2005
US 24/Meridian Road Construction Plans
US 24 PEL Final Corridor Conditions Report, December 2016

Tables 2-4



**Table 2
Trip Generation Estimate
The Commons at Falcon Field**

Land Use Code	Land Use Description	Trip Generation Units	Trip Generation Rates ⁽¹⁾					Total Trips Generated					Total Internal Trips Generated ⁽²⁾					Total External Trips Generated					Pass-by Trip Percent ⁽³⁾	Total Passby Trips Generated Average Weekday Traffic	Diverted Link Trip Percent ⁽³⁾	Total Diverted Link Trips Generated Average Weekday Traffic	Total New "External" Trips Generated Average Weekday Traffic
			Average Weekday Traffic	Morning Peak-Hour In	Morning Peak-Hour Out	Afternoon Peak-Hour In	Afternoon Peak-Hour Out	Average Weekday Traffic	Morning Peak-Hour In	Morning Peak-Hour Out	Afternoon Peak-Hour In	Afternoon Peak-Hour Out	Average Weekday Traffic	Morning Peak-Hour In	Morning Peak-Hour Out	Afternoon Peak-Hour In	Afternoon Peak-Hour Out	Average Weekday Traffic	Morning Peak-Hour In	Morning Peak-Hour Out	Afternoon Peak-Hour In	Afternoon Peak-Hour Out					
Trip Generation Estimate Based on the Currently Proposed Land Use																											
821	Shopping Plaza (40-150 KSF No Supermarket)	84 KSF ⁽⁵⁾	67.52	1.07	0.66	2.54	2.65	5,672	90	55	214	222	283	1	1	21	6	5,389	89	54	193	216	34%	1,832	26%	1,401	2,156
210	Single-Family Detached Housing	170 DU ⁽⁴⁾	9.43	0.18	0.53	0.59	0.35	1,603	30	89	101	59	167	1	1	6	21	1,436	29	88	95	38	0%	0	0%	0	1,436
								7,275	120	144	315	281	450	2	2	27	27	6,825	118	142	288	254		1,832		1,401	3,592
Trip Generation Estimate From the Falcon Field 2021 Rezone Master Traffic Impact Study																											
821	Shopping Plaza (40-150 KSF No Supermarket)	84 KSF	67.52	1.07	0.65	2.55	2.64	5,672	90	55	214	222	227	6	4	15	16	5,445	84	51	199	206	34%	1,851	0%	0	3,594
210	Single Family Detached Housing	80 DU	10.28	0.20	0.56	0.64	0.38	822	16	45	51	30	102	2	3	8	7	720	14	42	43	23	0%	0	0%	0	720
220	Multi Family Housing (Low Rise)	145 KSF	6.93	0.11	0.36	0.36	0.21	1,005	16	52	52	31	125	2	3	8	8	880	14	49	44	23	0%	0	0%	0	880
								7,499	122	152	317	283	454	10	10	31	31	7,045	112	142	286	252		1,851		0	4,474
	Change in Trip Generation Estimate							-224	-2	-8	-2	-2	-4	-8	-8	-4	-4	-220	6	0	2	2		-19			-882

Notes:

- (1) Source: *Trip Generation*, 11th Edition, 2021 by the Institute of Transportation Engineers (ITE)
- (2) Internal trips were based on the attached NCHRP 684 Internal Trip Capture Estimation Tool.
- (3) Source: *Trip Generation Handbook - An ITE Proposed Recommended Practice 3rd Edition*, September 2017 by ITE
- (4) DU = dwelling unit
- (5) KSF = 1,000 square feet

Source: LSC Transportation Consultants, Inc.

Table 3: Auxiliary Lane Analysis - Lane Dimensions and Projected Queues

Intersection	Turning Movement	Recommended Length (feet)	ECM/CDOT Standard (feet)	Maximum Queue (feet)
US 24/Woodmen	Northwestbound Left*	260 Decel + Storage 80 Bay Taper	155 Decel 150 Storage 160 Bay Taper	137
	Northwestbound Through	260 (second through lane)	- - -	196
	Northwestbound Right	260 Decel	155 Decel	0
	Northeastbound Right (Accel)	960 Accel 225 Taper	960 Accel 225 Taper	- - -
	Northeastbound Right	600 Decel 225 Taper	600 Decel 225 Taper	64
	Southwestbound Left	600 Decel 100 Storage 225 Taper	600 Decel 100 Storage 225 Taper	255
Retail Row St/ Dunlin Dr/ Nunbird Ct	Eastbound Left	165 (Decel + Storage) 80 Bay Taper	115 Decel 50 Storage 80 Bay Taper	<5
	Westbound Left	100 (Decel + Storage) 65 Bay Taper	115 Decel 50 Storage 80 Bay Taper	46
Retail Row St/ Willet Way	Eastbound Left	120 (Decel + Storage) 50-75 Bay Taper	115 Decel 100 Storage 80 Bay Taper	36
*Potential long-term future 2nd left turn to be striped out with initial construction				Mar-24

Table 4. Recommended Improvements

Item #	Improvement	Timing	Responsibility
Roadway Segment Improvements			
1	Construct Retail Row Street as an Urban Non-Residential Collector with a modified cross section	With the subdivision (plat)	Applicant
2	Rio Lane: add sidewalk, curb and gutter along Rio Lane adjacent to the site as shown on the Preliminary Plan; Please refer to the Rio Land and Rio Road section of the narrative.	With adjacent development	Applicant
3	Widen US Highway 24 to provide two through lanes in each direction from Garrett Road to east of Woodmen Road, plus associated/other corridor improvements.	Per recent meeting with CDOT: Construction to begin 2025.	CDOT/US Highway 24 project
US Highway 24/Woodmen Road Intersection			
4	Extend the southwestbound left-turn deceleration lane plus transition taper on US Hwy 24 (westbound) approaching Woodmen Road to 700 feet. This requires widening of the box culvert under US Hwy 24 just west of the US Hwy 24/Rio Lane intersection.	With site development, when the peak-hour volume for this movement exceeds 10 vph Requires the closure of Rio Lane	Applicant
5	Potential future lengthening/extension of the southwestbound right-turn deceleration lane on US Highway 24 at Woodmen Road to CDOT standards (600 feet plus transition taper).	To be determined by CDOT	CDOT (potentially as part of the US Highway 24 project) Note: any additional cost associated with any culvert widening needed specifically for the right-turn lane, and the lengthening of the right turn lane itself should not be the responsibility of this applicant.
6	Construct a 600 foot-long northeastbound right-turn deceleration lane plus transition taper on US Hwy 24 (eastbound) approaching Woodmen Road	With site development, when the peak-hour volume for this movement exceeds 10 vph	Applicant
7	Construct a northwestbound right-turn acceleration lane on US Hwy 24 (eastbound) from the Woodmen Road intersection. Rio Lane would be closed with the added southern leg of the Woodmen/US Hwy 24 intersection and this will allow for the full-length, CDOT standard acceleration lane.	With site development, when the peak-hour volume for this movement exceeds 10 vph	Applicant
8	Construct a 960 foot-long northwestbound right-turn acceleration lane (plus transition taper) on US Hwy 24 (eastbound) east of Woodmen Road.	With the closure of Rio Lane	Applicant
9	Construct the southeast leg of the intersection. as shown in Figure 11b. Modify the northwest leg of this intersection such that lanes need to align across US Hwy 24 (also shown in Figure 11b) (within allowable/acceptable lane offset tolerances and considering protected/permissive left-turn sight distance and left-turning vehicle paths).	With the subdivision (plat)	Applicant
10	Construct 260' northwestbound left-turn lane plus 80' Taper.	With the subdivision (plat)	Applicant
11	Construct 260' northwestbound right-turn deceleration lane plus 80' Taper.	With the subdivision (plat)	Applicant
12	Modify the northwest leg (Woodmen Road) as needed so lanes align across US Hwy 24; construct raised/curbed right turn islands for pedestrians and for installing a signal pole on the northeast corner, construct a sidewalk connection to the Rock Island Trail (which connects to the sidewalk along the north side of Woodmen Road adjacent to the Falcon Town Center (Safeway).	With the subdivision (plat)	Applicant
13	Traffic signal system modifications, pedestrian accommodations, signing/stripping improvements to convert the existing intersection from a T intersection to a four-leg intersection.	With the subdivision (plat)	Applicant
Retail Row Street			
14	Construct a modern roundabout at Woodmen/Retail Row Street (See roundabout figures and design parameters table)	With the subdivision (plat)	Applicant
15	Construct 165 foot long northeastbound left-turn lane plus 80-foot taper on Retail Row Street approaching Dunlin Drive.	With the subdivision (plat)	Applicant
16	Construct 100 foot long southwestbound left-turn lane plus 65-foot reverse curve bay taper on Retail Row Street approaching Nunbird Court	With the subdivision (plat)	Applicant
17	Construct 120 foot long northeastbound left-turn lane plus 50 to 75-foot reverse curve bay taper on Retail Row Street approaching Willet Way	With the subdivision (plat)	Applicant
US Highway 24 Right-of-Way Dedication & Preservation			
18	CDOT required Right-of-way Dedication & Preservation along US Highway 24	With the subdivision (plat)	Applicant
US Highway 24/Rio Lane Intersection			
19	Close intersection in conjunction with Improvement Nos. 1 and 9	Short-Term - CDOT indicated at a recent meeting that the Rio Lane connection to Highway 24 will need to be closed with Improvement No. 9.	Applicant
Falcon Highway/Rio Lane Intersection			
20	Construct westbound right-turn deceleration lane	Once westbound right-turning volume exceeds 50 right-turning vehicles per hour.	Applicant

Source: LSC Transportation Consultants, Inc. (3-26-24)

Figures 1-12





Figure 1

Vicinity Map

Commons at Falcon Field (LSC# S234220)

Intersection to be closed. This will remove Rio Lane access to US 24 at this location.

New public street connection to Rio Lane in conjunction with closure of the US Highway 24/Rio intersection.

Proposed full-movement urban local street connection

Approximate Scale
1" = 400'



Proposed right-in-only commercial access point

Proposed full-movement commercial access point (treated as a public street intersection)

Proposed full-movement commercial access point

Proposed full-movement commercial access point (treated as a public street intersection)

Proposed full-movement urban local street connection

Note: this is an "unofficial graphic" of the preliminary plan for inclusion in this TIS. Please refer to the Preliminary Plan sheet by Drexel Barrel included with this submittal for the official copy and/or for additional detail.

Street stubs for future connections - if ever needed (by others). Connections are not proposed at this time.

Possible pedestrian connection

Figure 2a

Site Plan

Commons at Falcon Field (LSC# S234220)



TRANSPORTATION CONSULTANTS, INC.

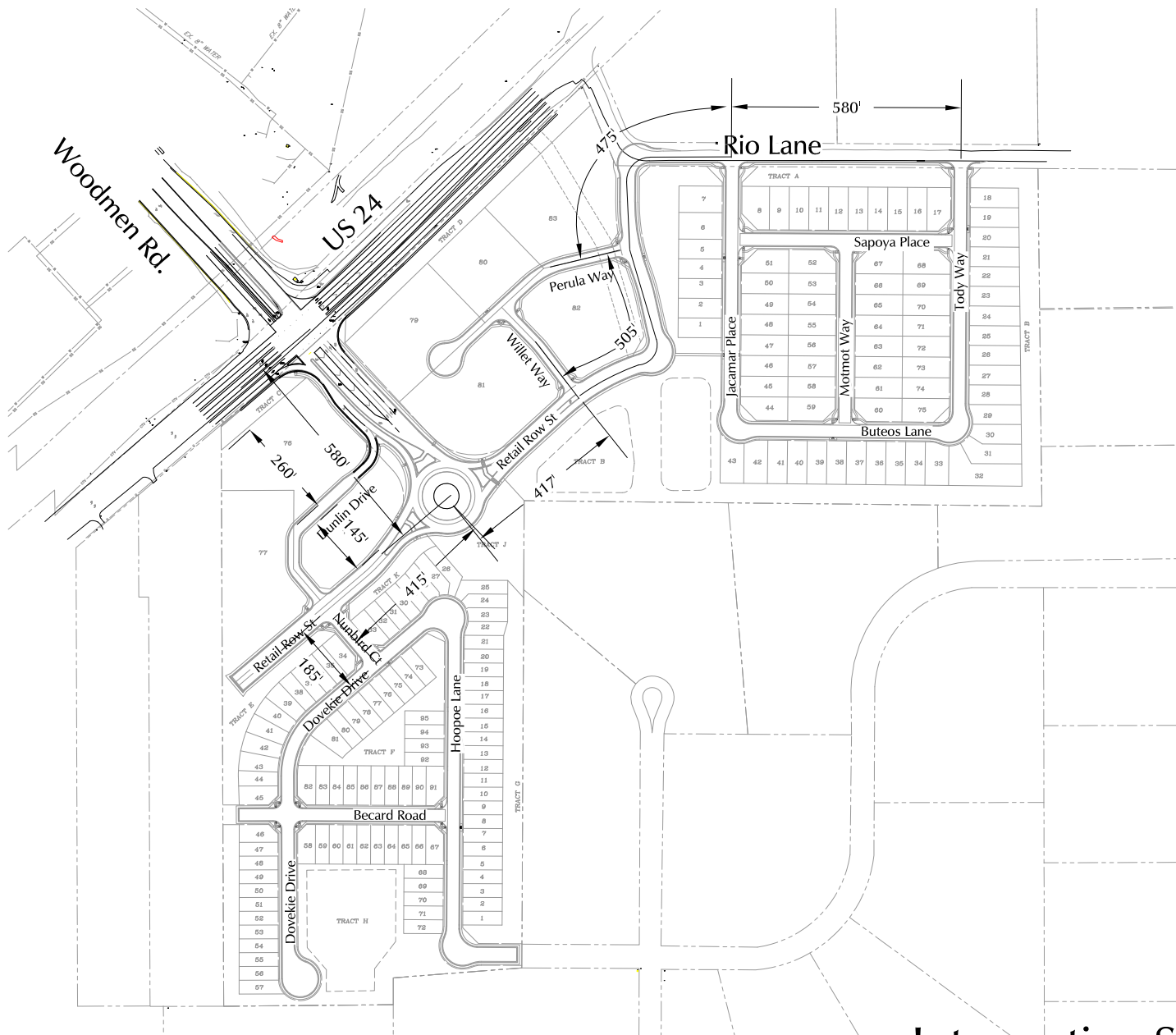



 Approximate
 Scale
 1" = 400'

Figure 2b
Intersection Spacing
 Commons at Falcon Field (LSC# S234220)

- Intersection/Access centerline spacing (measured along the street centerline(s))





1"=100'

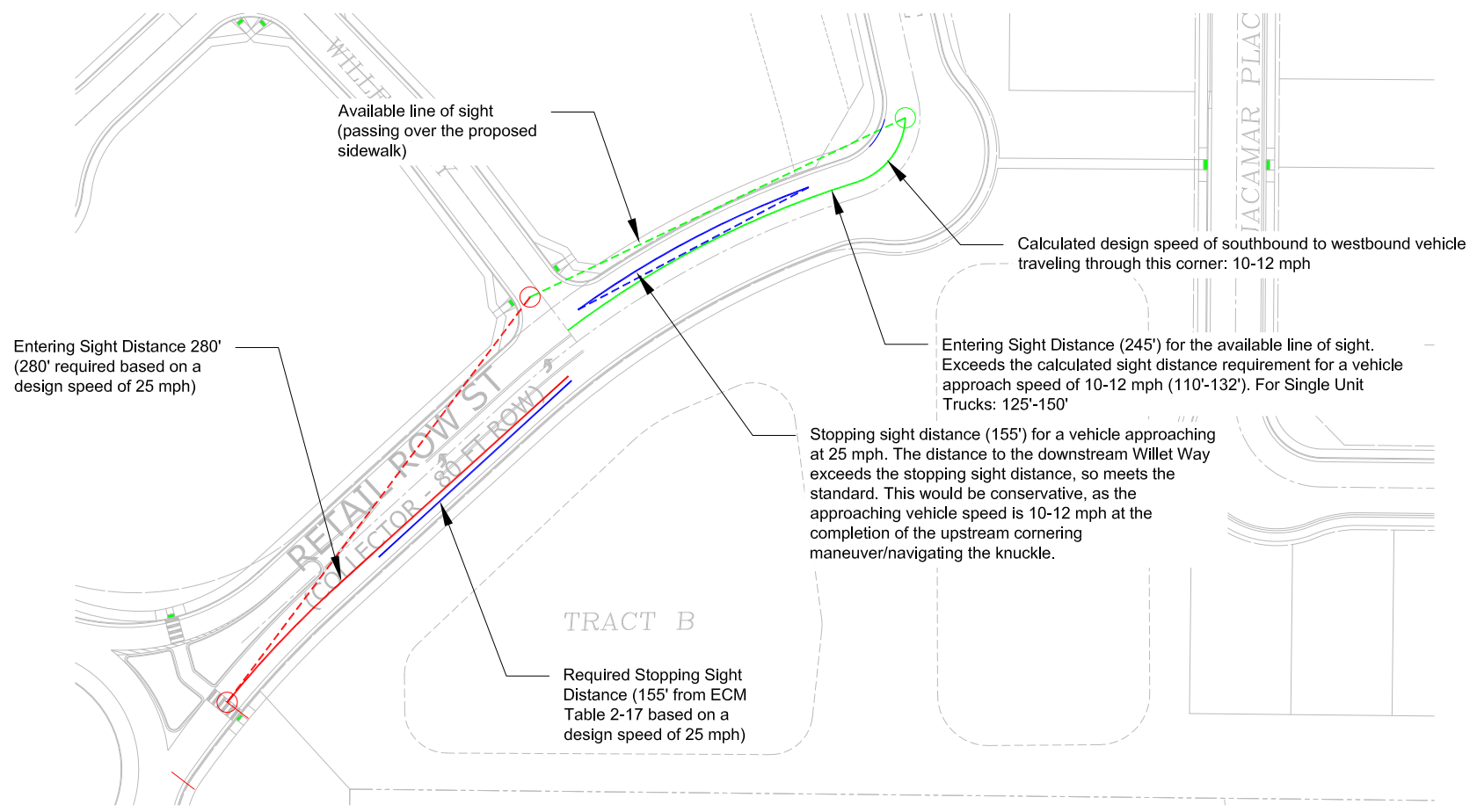

Figure 3a

Sight Distance Analysis Retail Row St./Willet Way

Commons at Falcon Field (LSC# 234220)





Approximate Scale
1" = 60'

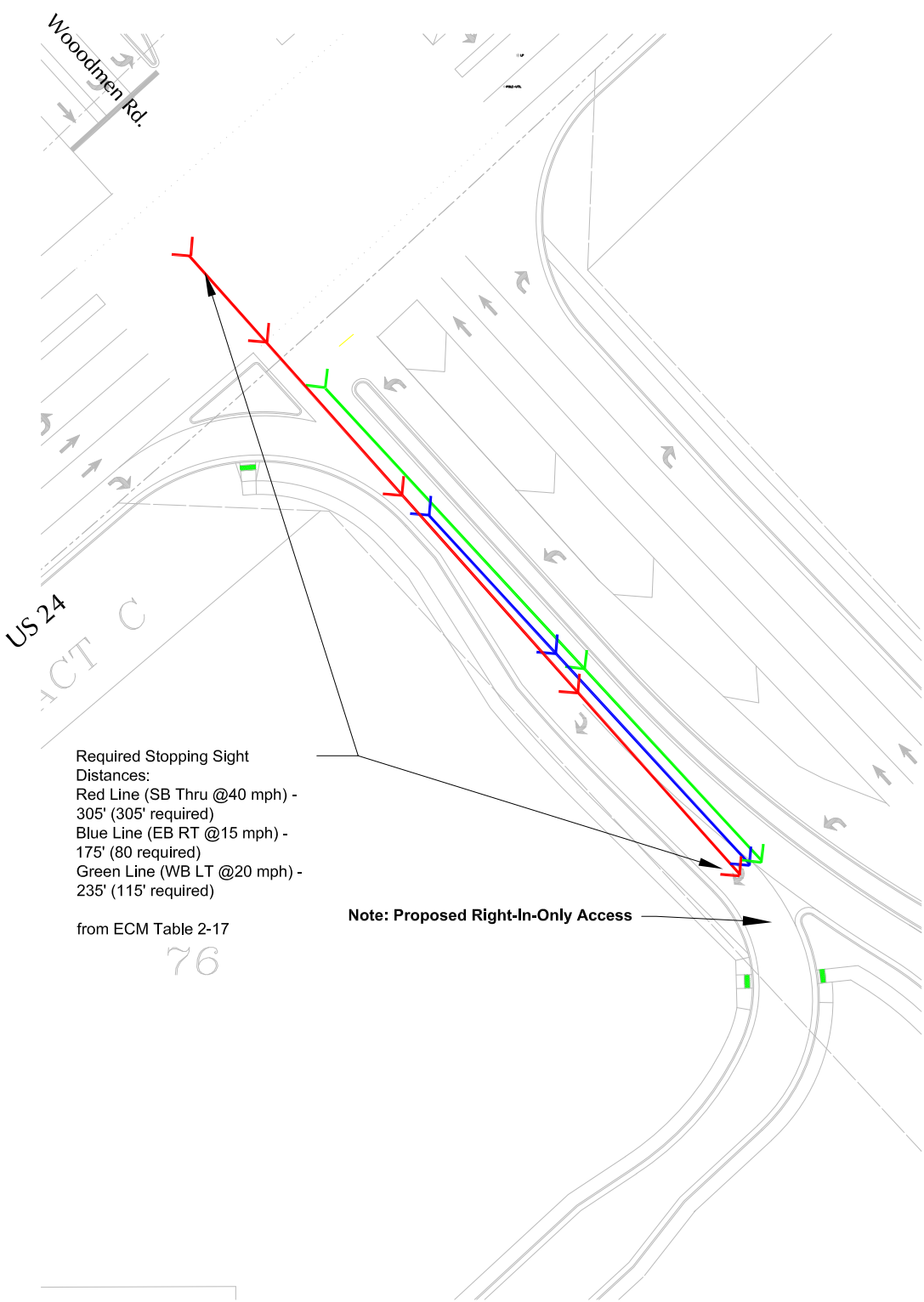

Required Stopping Sight
Distances:
Red Line (SB Thru @40 mph) -
305' (305' required)
Blue Line (EB RT @15 mph) -
175' (80 required)
Green Line (WB LT @20 mph) -
235' (115' required)

from ECM Table 2-17

76

Note: Proposed Right-In-Only Access

Figure 3b

Right-In-Only Access Stopping Sight Distance

Commons at Falcon Field (LSC# 234220)



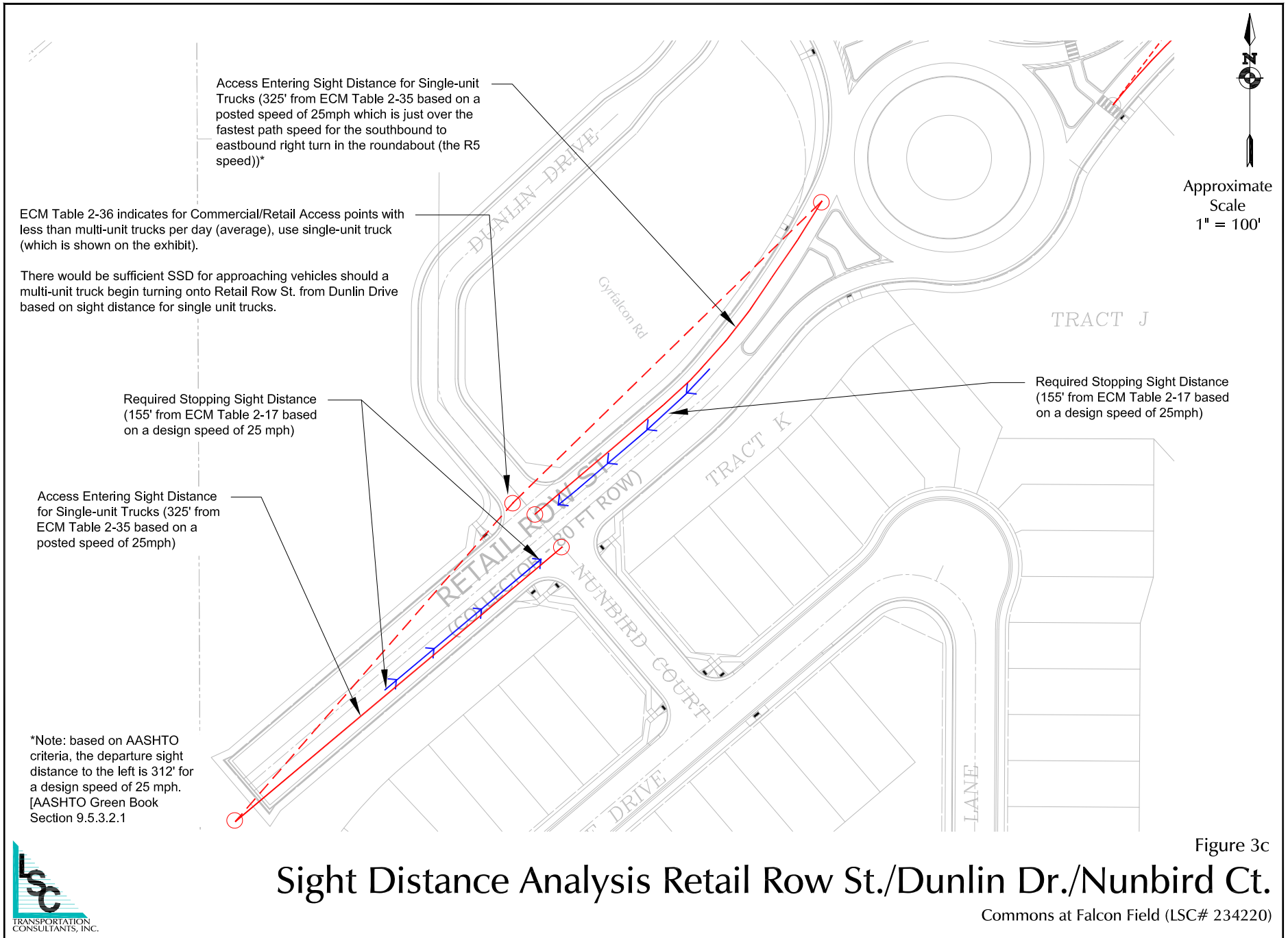



Approximate
Scale
1" = 150'

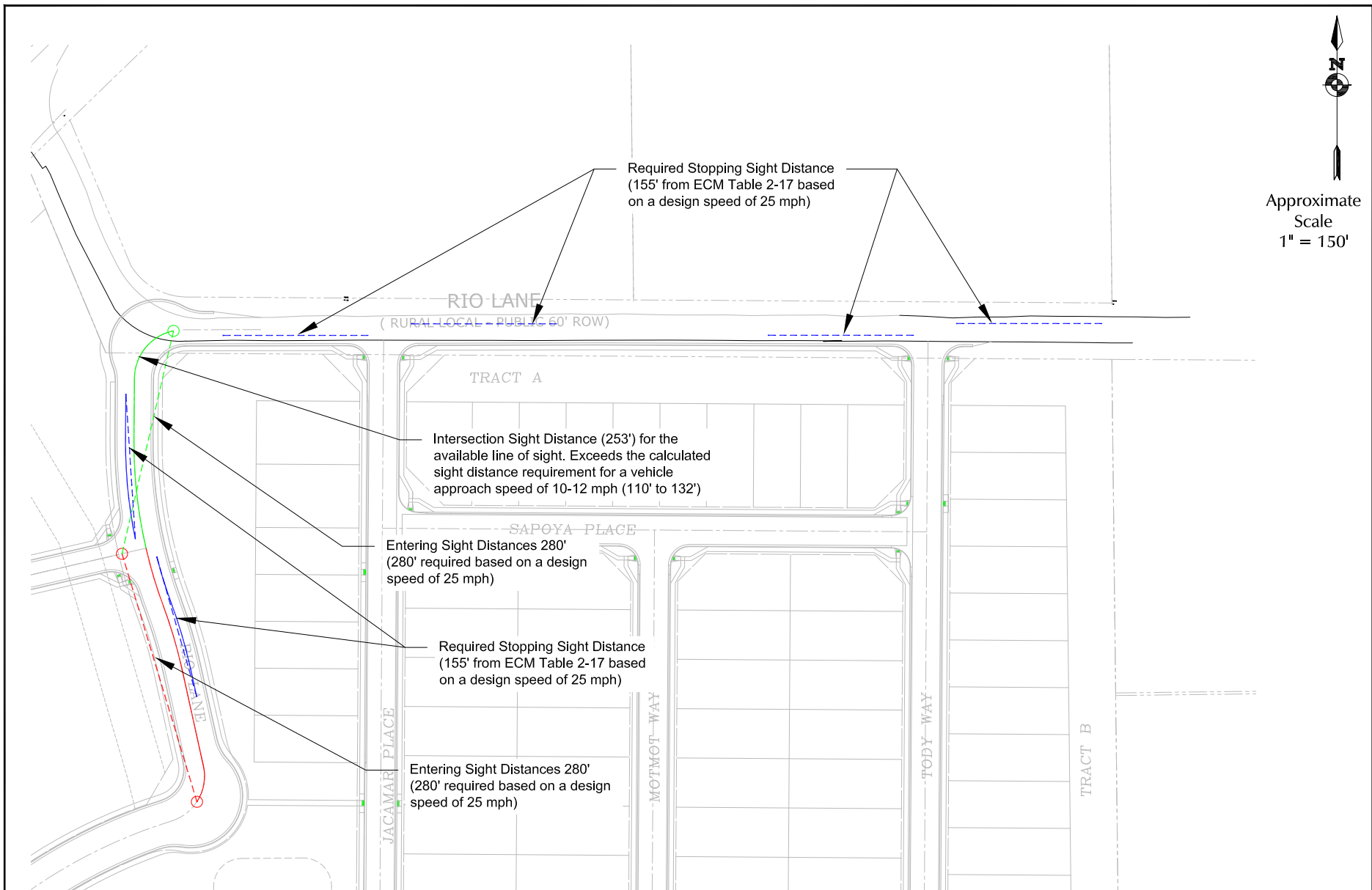

Sight Distance Analysis Rio Lane Access Points

Figure 3d

Commons at Falcon Field (LSC# 234220)

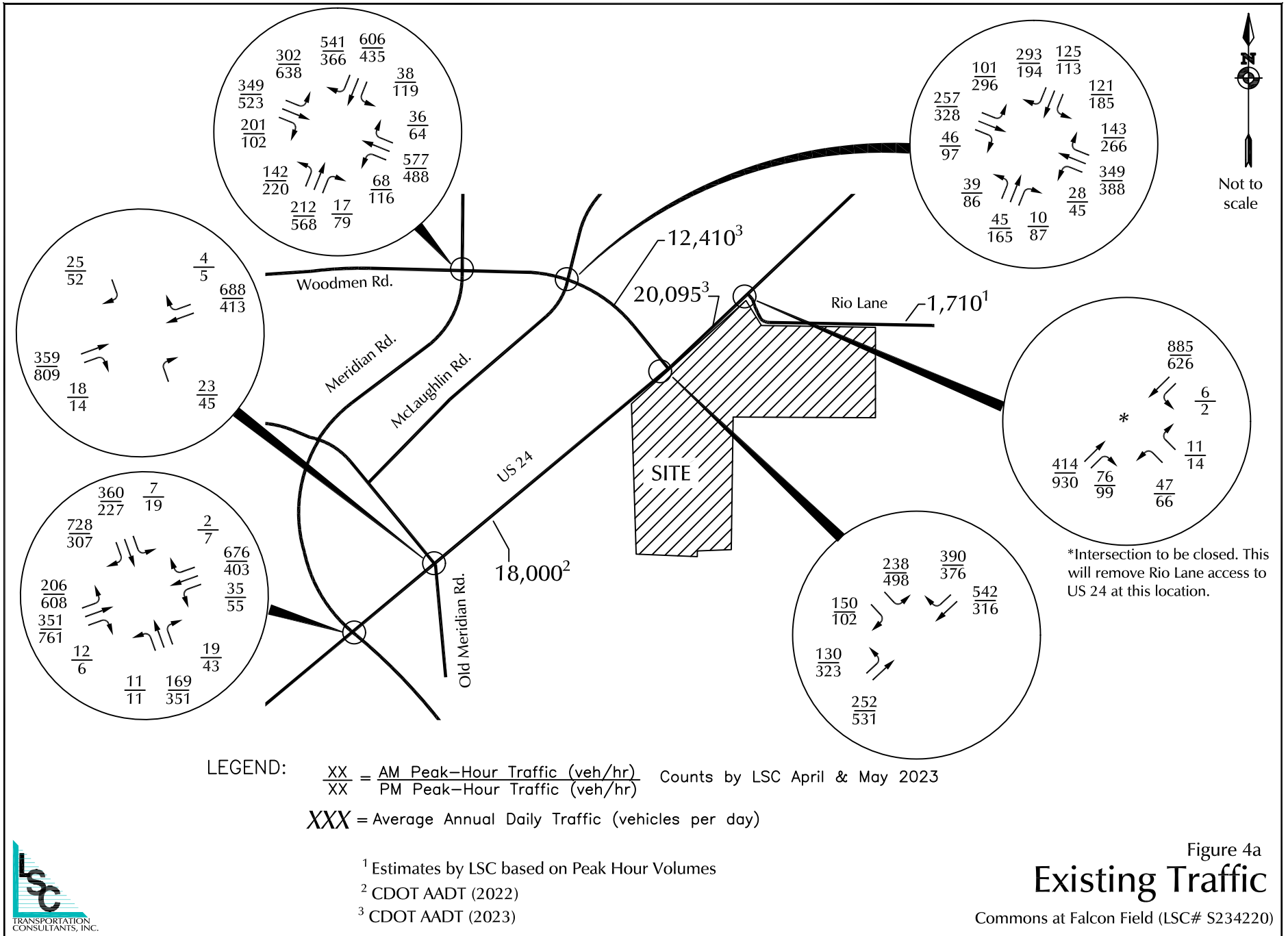

Figure 4a
Existing Traffic

Commons at Falcon Field (LSC# S234220)

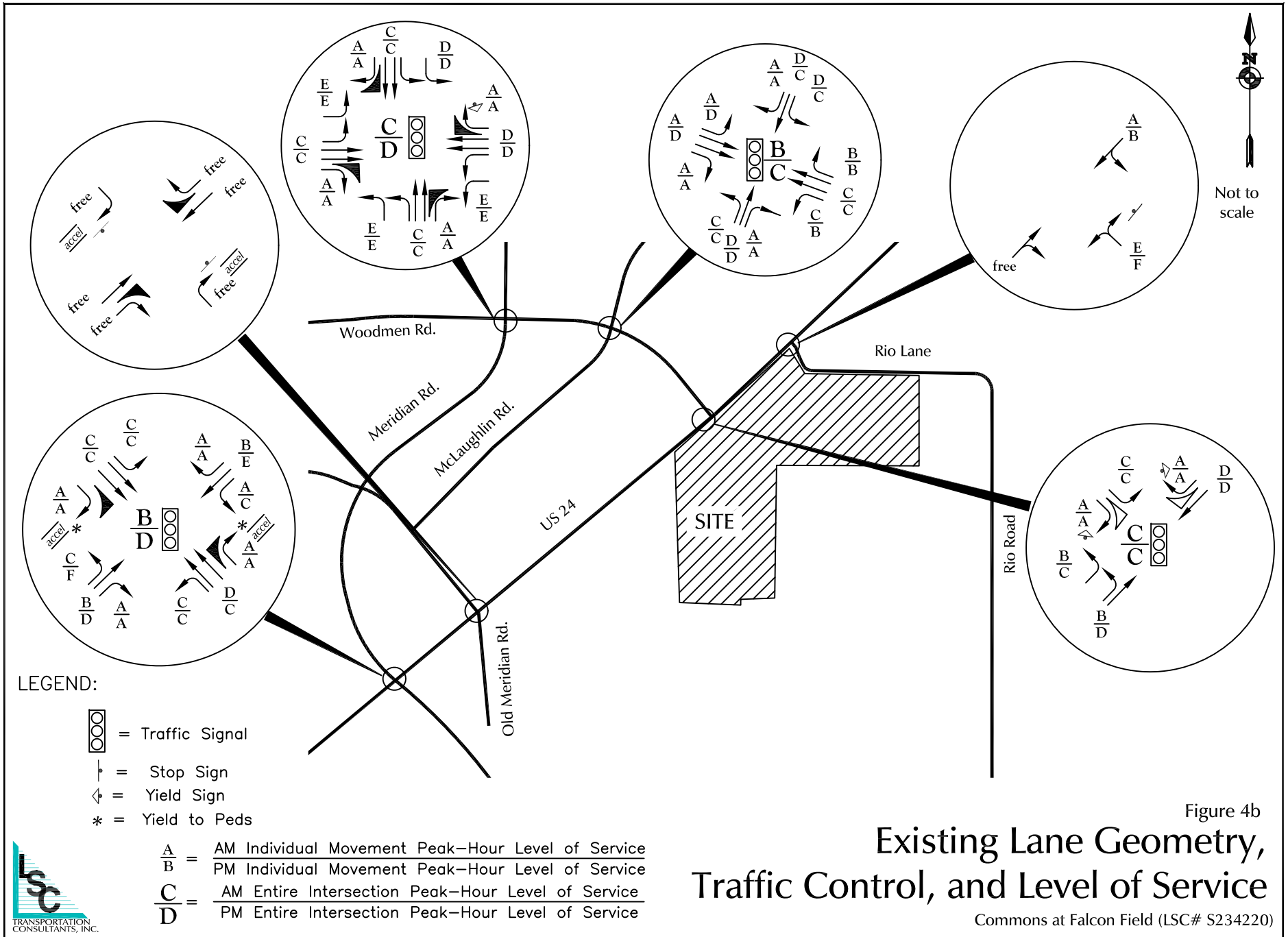
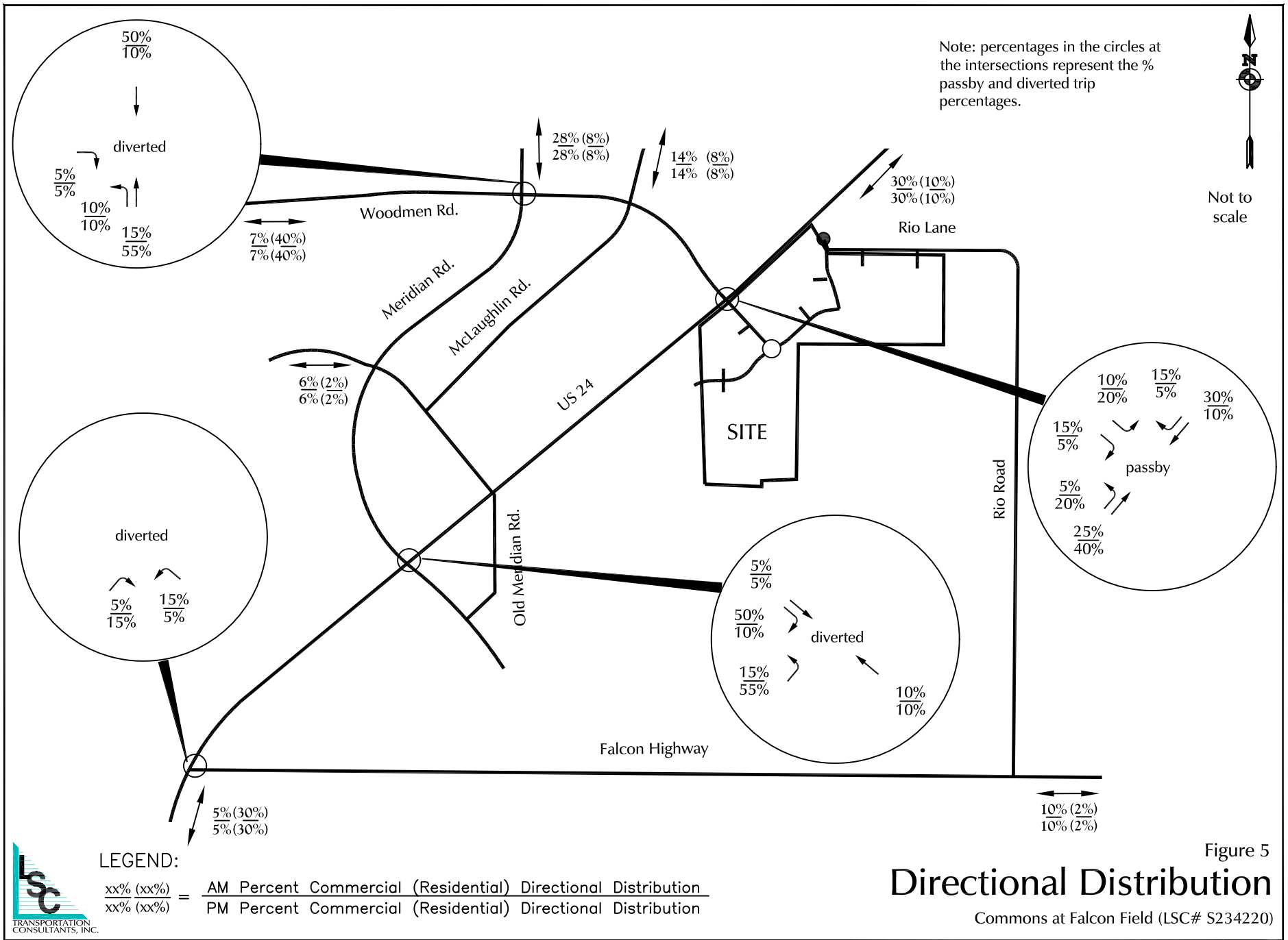
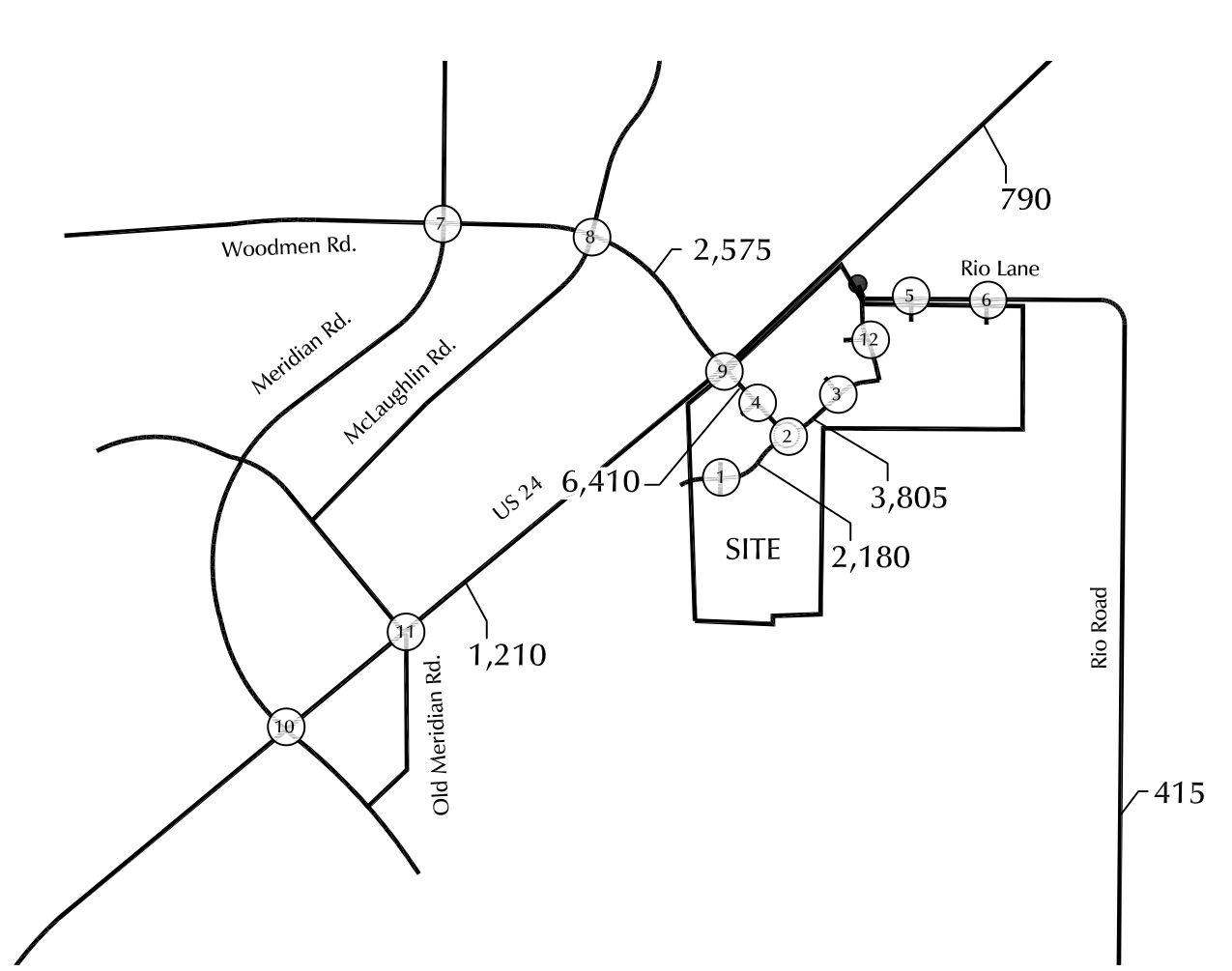
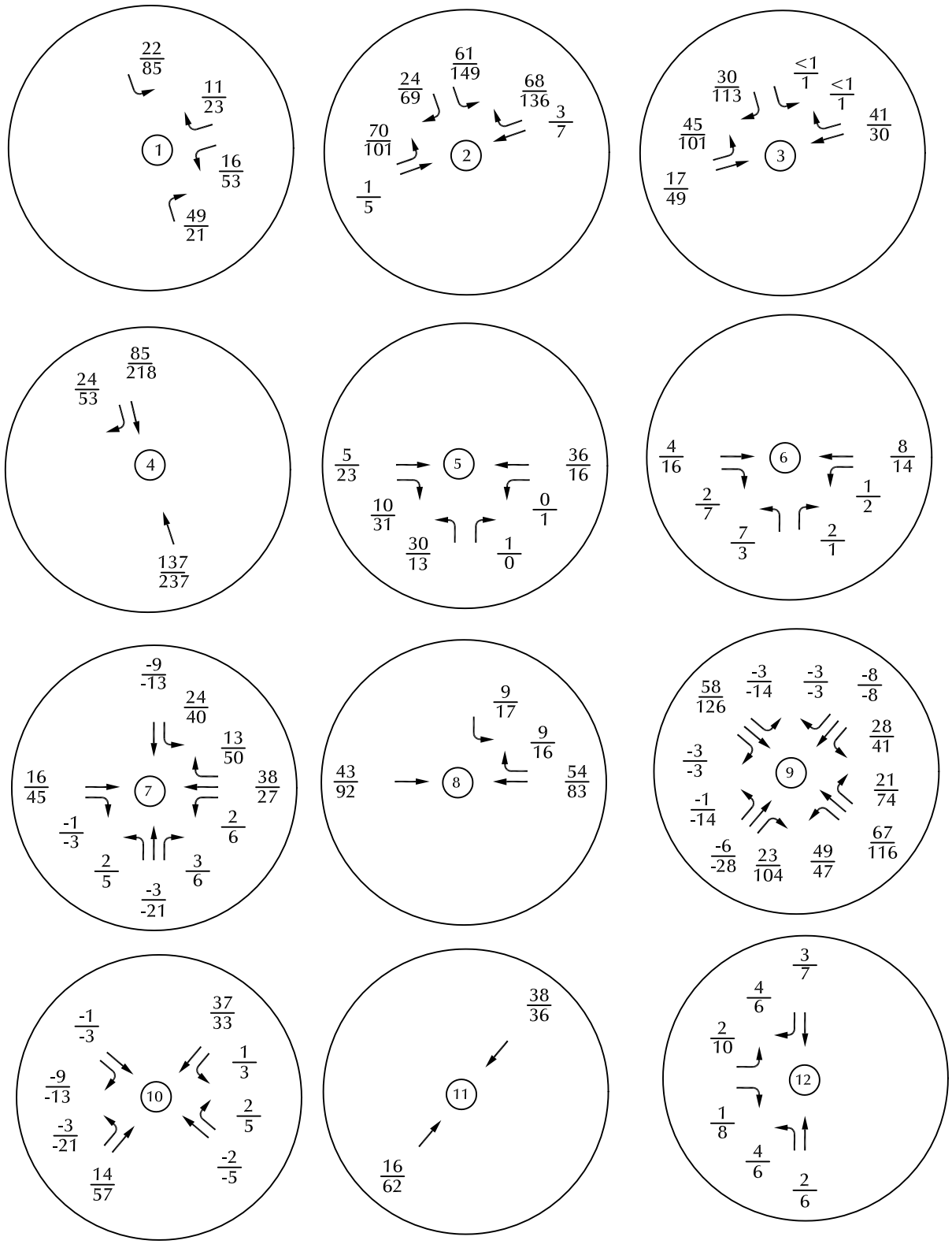

Figure 4b
**Existing Lane Geometry,
 Traffic Control, and Level of Service**
 Commons at Falcon Field (LSC# S234220)





LEGEND: $\frac{XX}{XX}$ = AM Peak-Hour Traffic (veh/hr)
 $\frac{XX}{XX}$ = PM Peak-Hour Traffic (veh/hr)
 XXX = Average Weekday Traffic (vehicles per day)

Figure 6
Site-Generated Traffic
 Commons at Falcon Field (LSC# S234220)



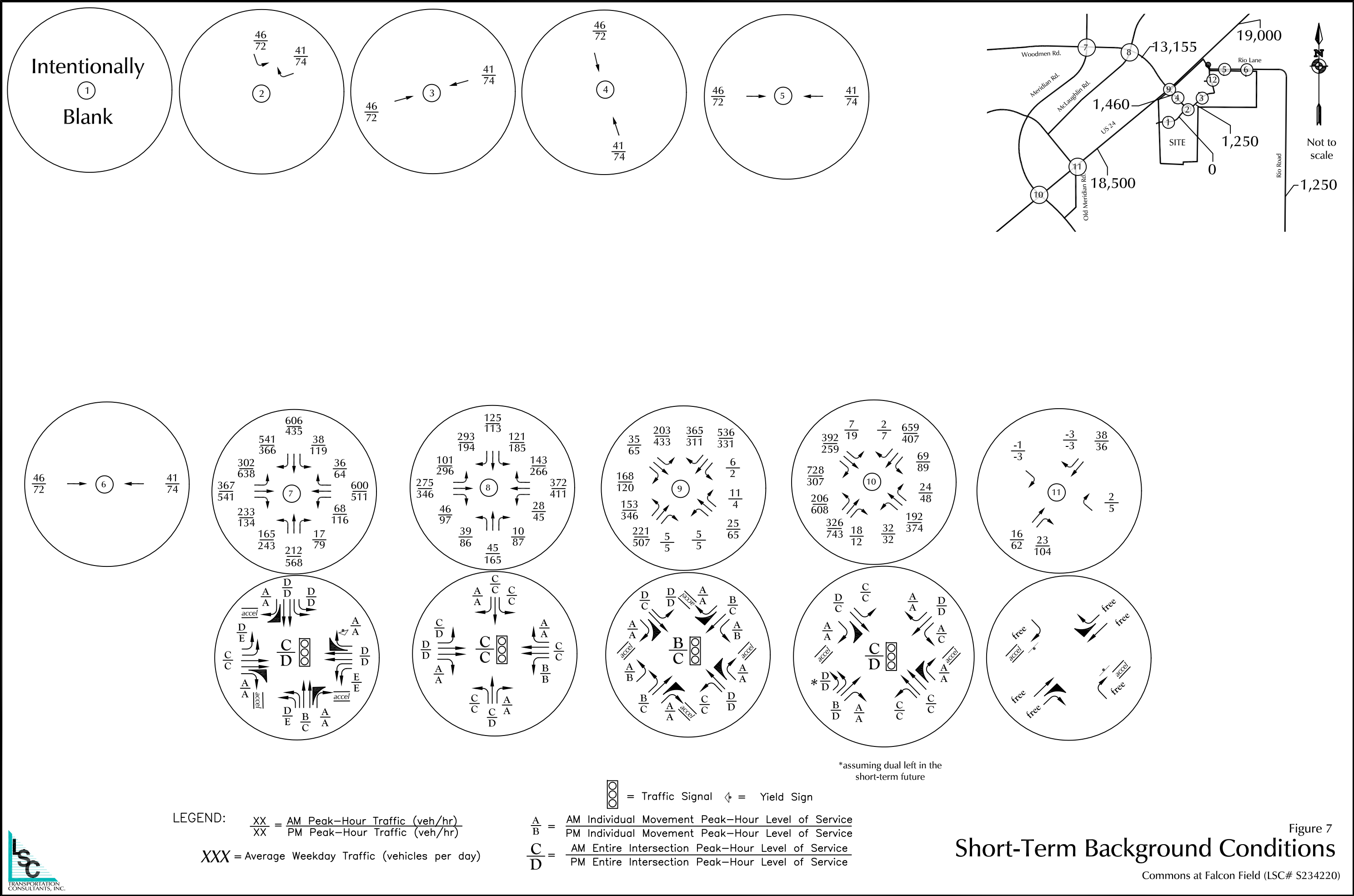

LEGEND: $\frac{XX}{XX} = \frac{\text{AM Peak-Hour Traffic (veh/hr)}}{\text{PM Peak-Hour Traffic (veh/hr)}}$
 XXX = Average Weekday Traffic (vehicles per day)

Traffic Signal = Traffic Signal \leftarrow = Yield Sign
 $\frac{A}{B} = \frac{\text{AM Individual Movement Peak-Hour Level of Service}}{\text{PM Individual Movement Peak-Hour Level of Service}}$
 $\frac{C}{D} = \frac{\text{AM Entire Intersection Peak-Hour Level of Service}}{\text{PM Entire Intersection Peak-Hour Level of Service}}$

*assuming dual left in the short-term future

Figure 7
Short-Term Background Conditions
 Commons at Falcon Field (LSC# S234220)

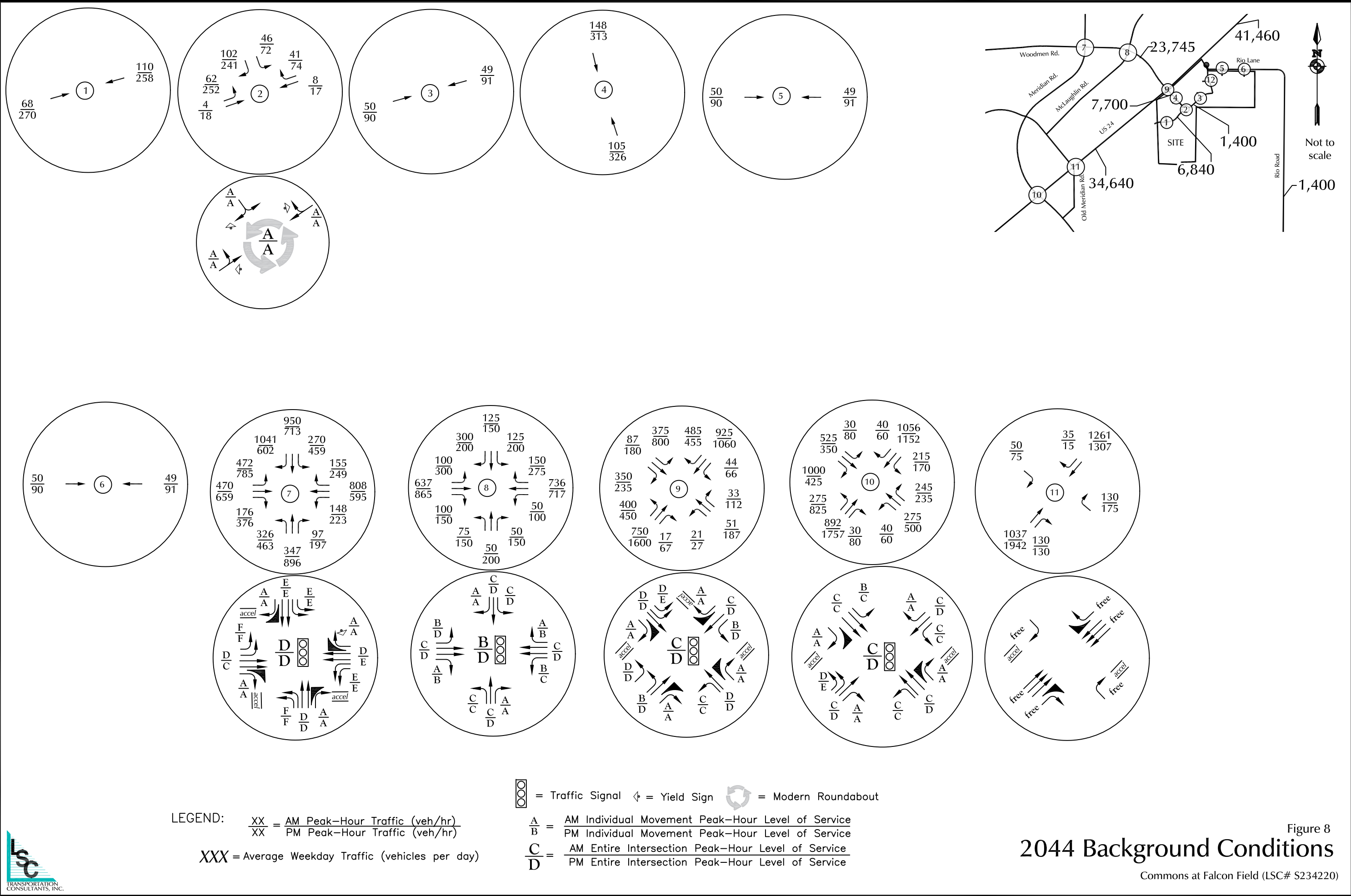

LEGEND: $\frac{XX}{XX}$ = AM Peak-Hour Traffic (veh/hr) / PM Peak-Hour Traffic (veh/hr)
 XXX = Average Weekday Traffic (vehicles per day)

= Traffic Signal = Yield Sign = Modern Roundabout
 $\frac{A}{B}$ = AM Individual Movement Peak-Hour Level of Service / PM Individual Movement Peak-Hour Level of Service
 $\frac{C}{D}$ = AM Entire Intersection Peak-Hour Level of Service / PM Entire Intersection Peak-Hour Level of Service

Figure 8
2044 Background Conditions
 Commons at Falcon Field (LSC# S234220)



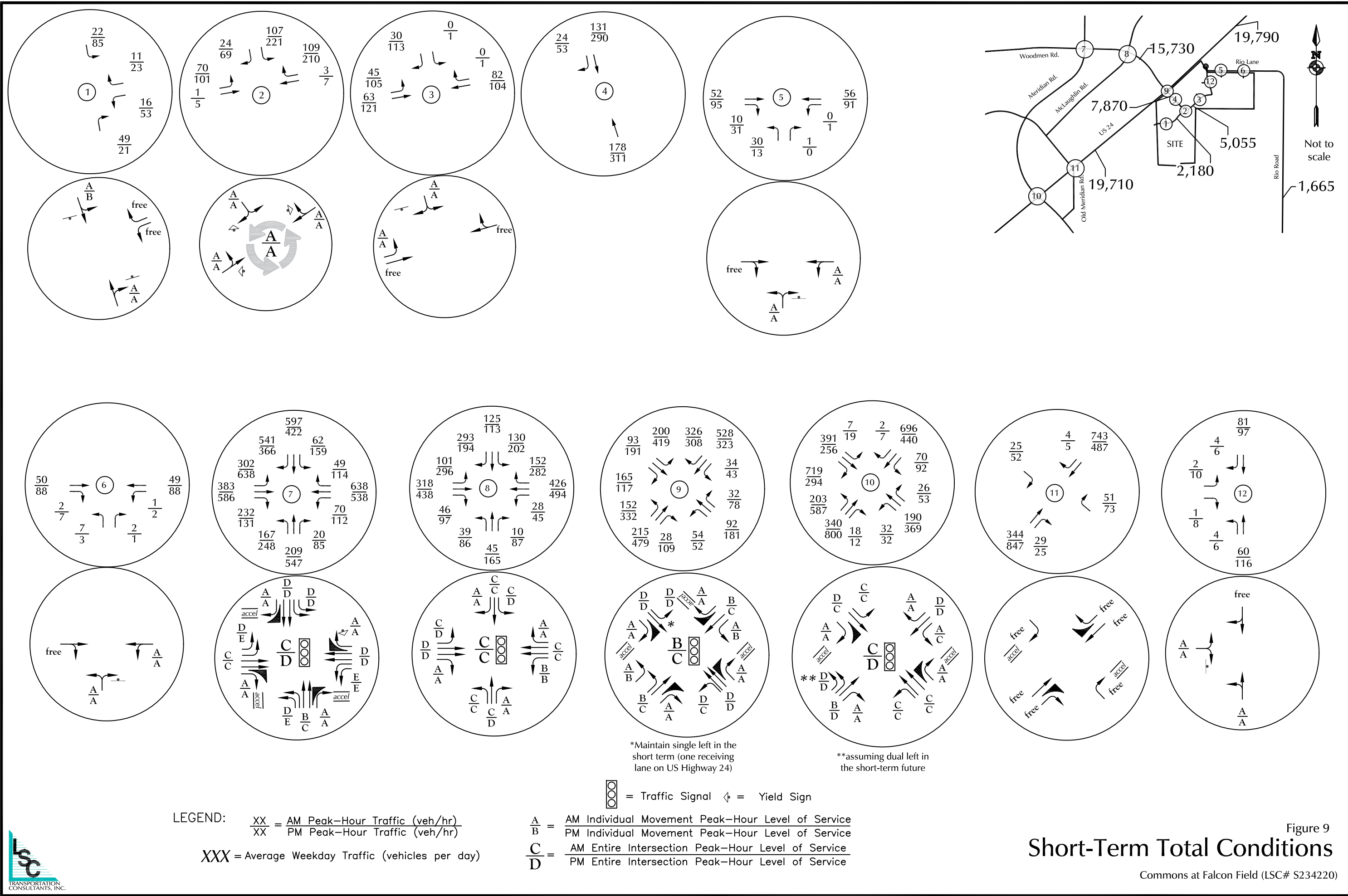
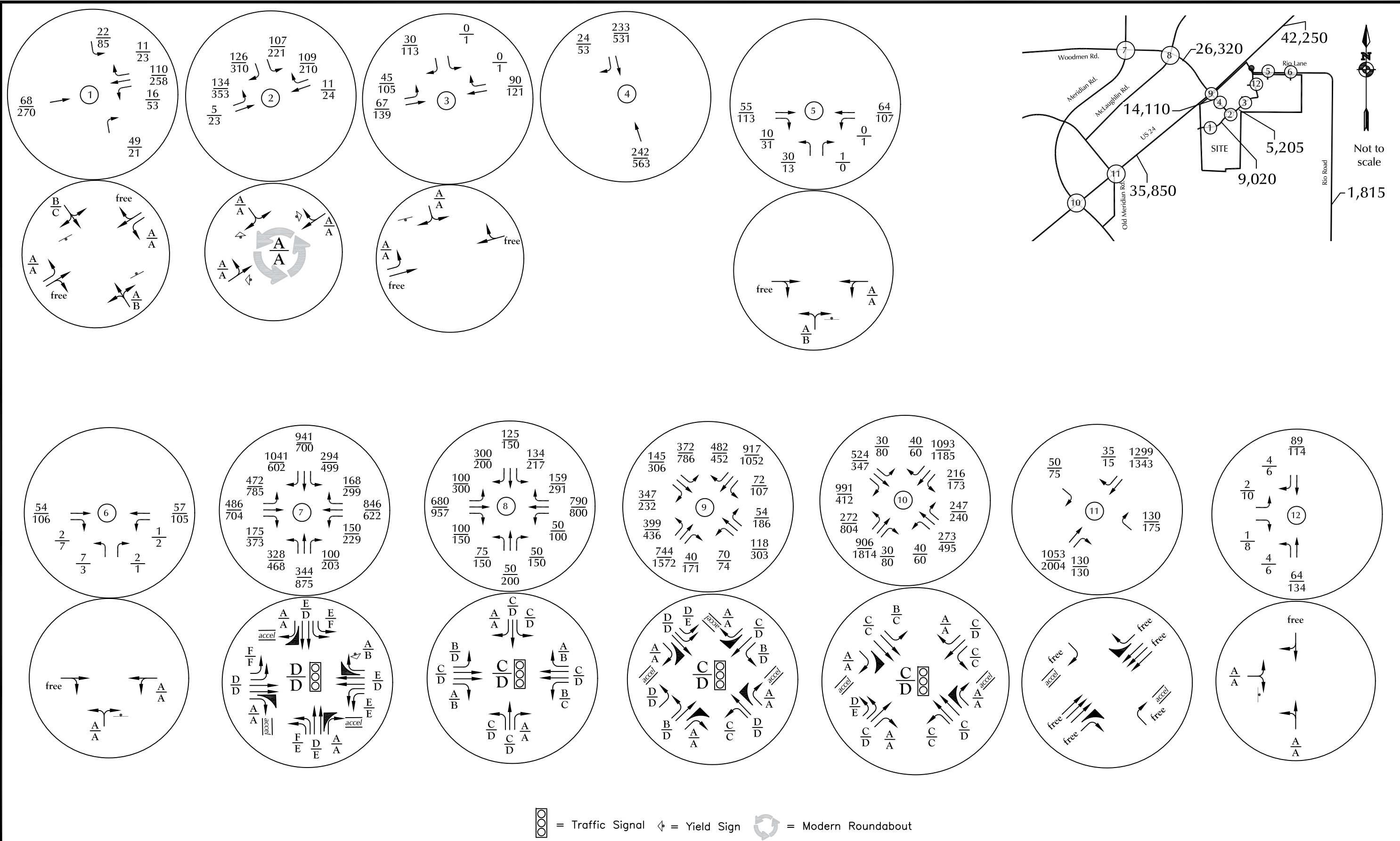

Figure 9
Short-Term Total Conditions

Commons at Falcon Field (LSC# S234220)





LEGEND: $\frac{XX}{XX}$ = AM Peak-Hour Traffic (veh/hr)
 $\frac{XX}{XX}$ = PM Peak-Hour Traffic (veh/hr)
 XXX = Average Weekday Traffic (vehicles per day)

= Traffic Signal = Yield Sign = Modern Roundabout
 $\frac{A}{B}$ = AM Individual Movement Peak-Hour Level of Service
 $\frac{A}{B}$ = PM Individual Movement Peak-Hour Level of Service
 $\frac{C}{D}$ = AM Entire Intersection Peak-Hour Level of Service
 $\frac{C}{D}$ = PM Entire Intersection Peak-Hour Level of Service

Figure 10
2044 Total Conditions
 Commons at Falcon Field (LSC# S234220)



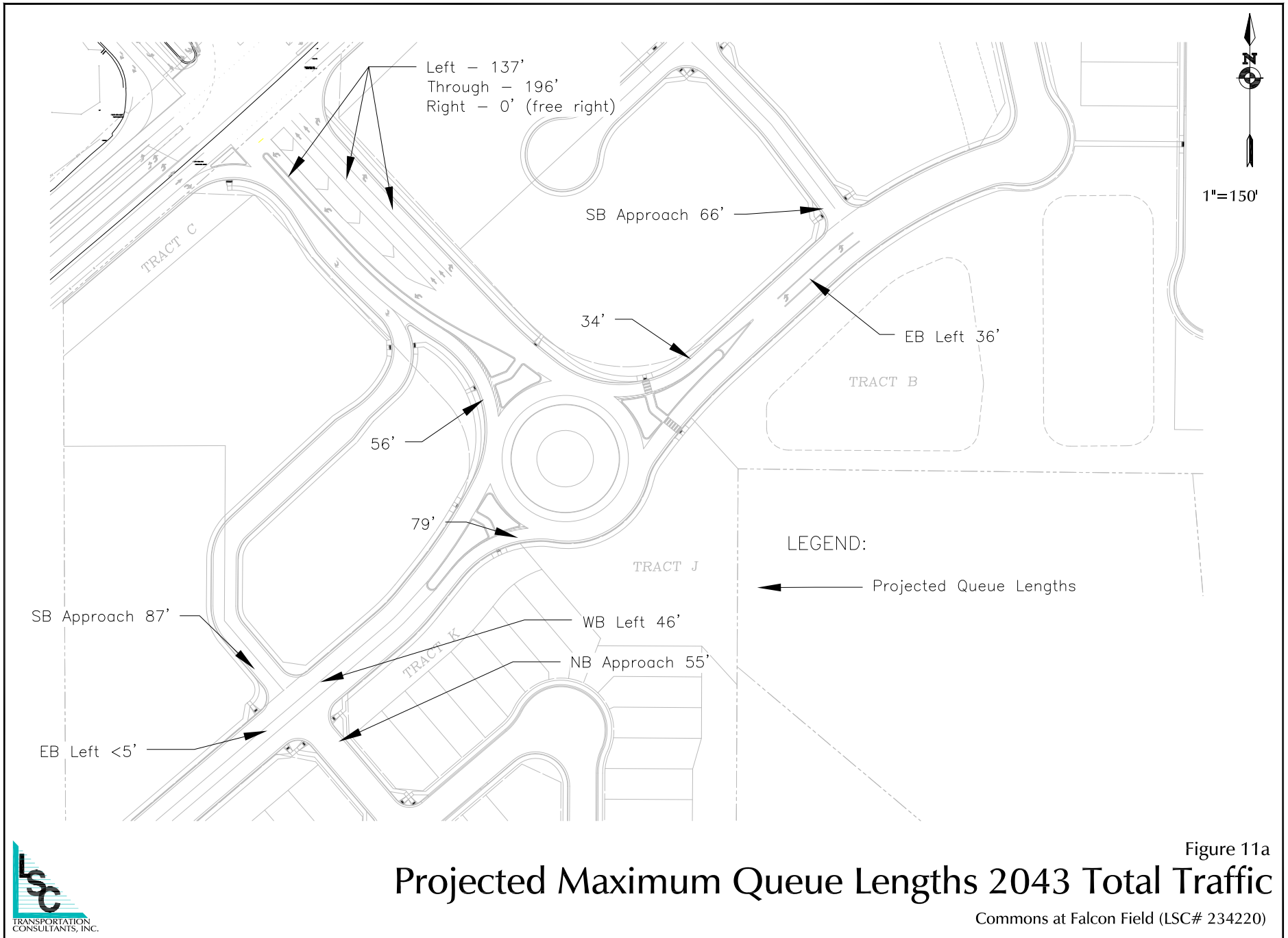

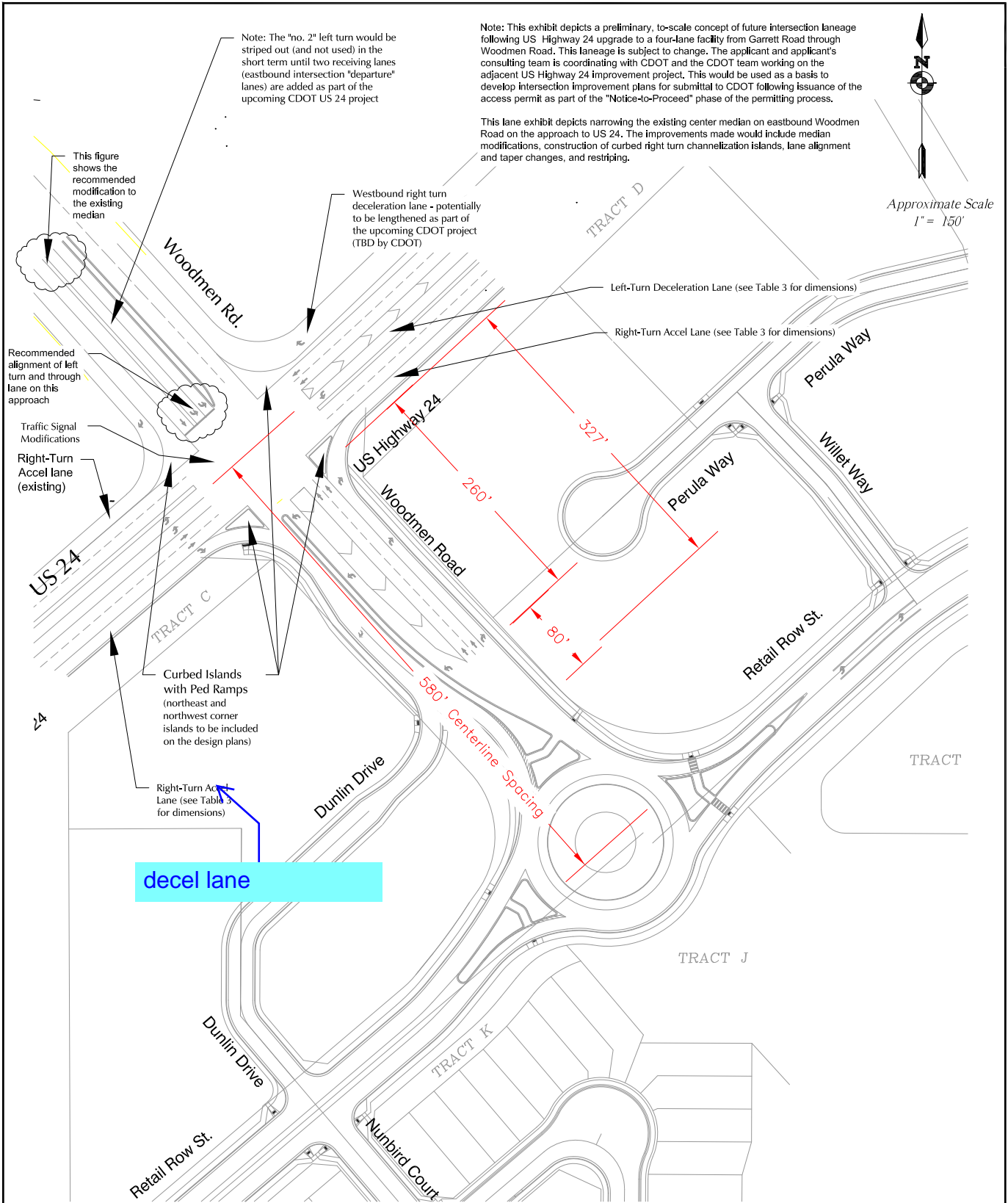

Note: This figure is an expanded copy of Deviation Exhibit 3-1 in Deviation No. 3

Figure 11b

Intersection Improvements at the Intersection of US 24/Woodmen Rd

Commons at Falcon Field (LSC# 234220)



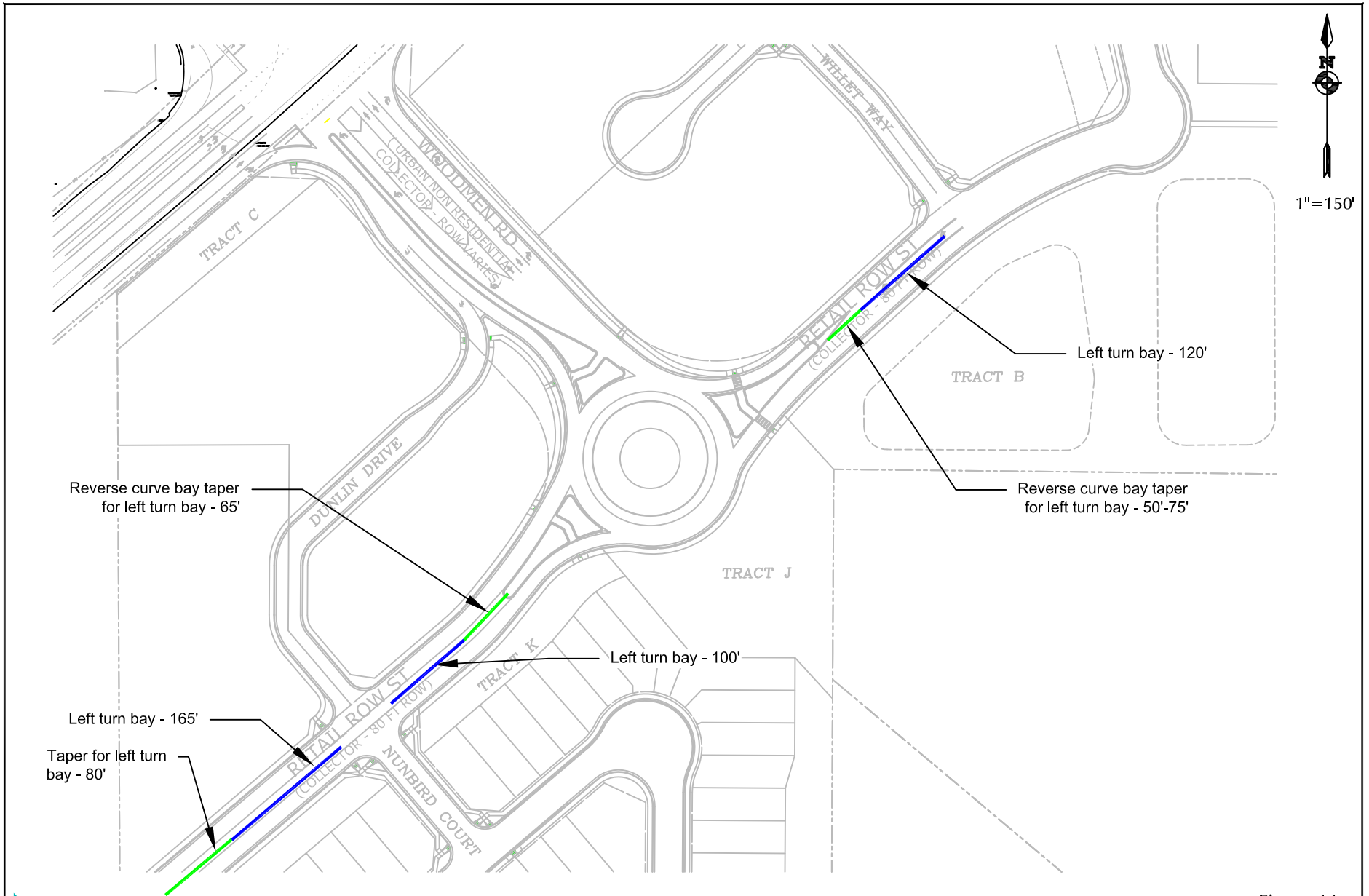

Note: this figure is a copy of
 Deviation Exhibit 3-2 from
 Deviation No. 3

Recommended Retail Row Street Left Turn Bay Dimensions

Figure 11c

Commons at Falcon Field (LSC# 234220)

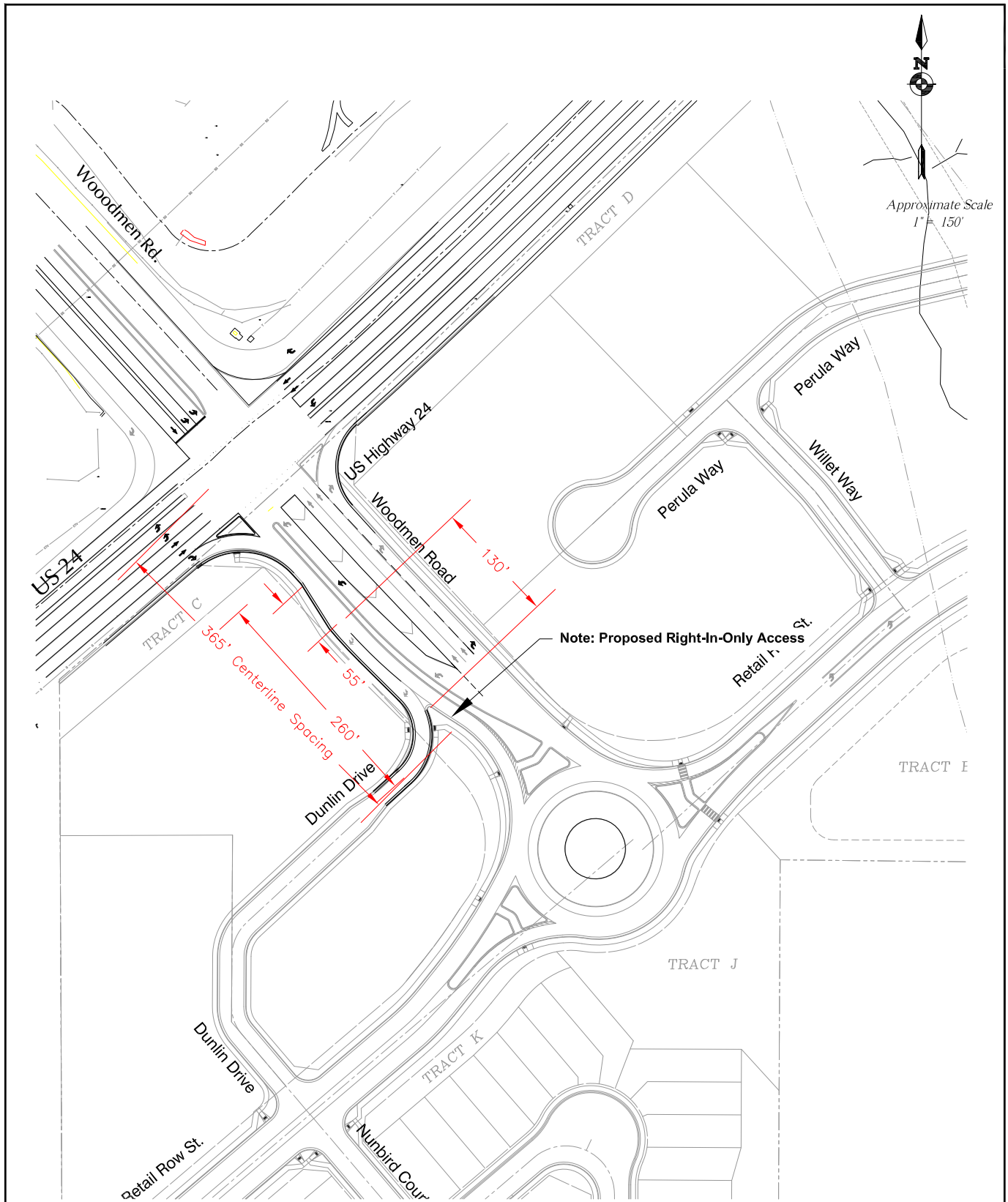

Note: this figure is a copy of
Deviation Exhibit 2a-1 from
Deviation No. 2a

Figure 11d

Right-In-Only Access Spacing/Laneage (Southbound Approach)

Commons at Falcon Field (LSC# 234220)



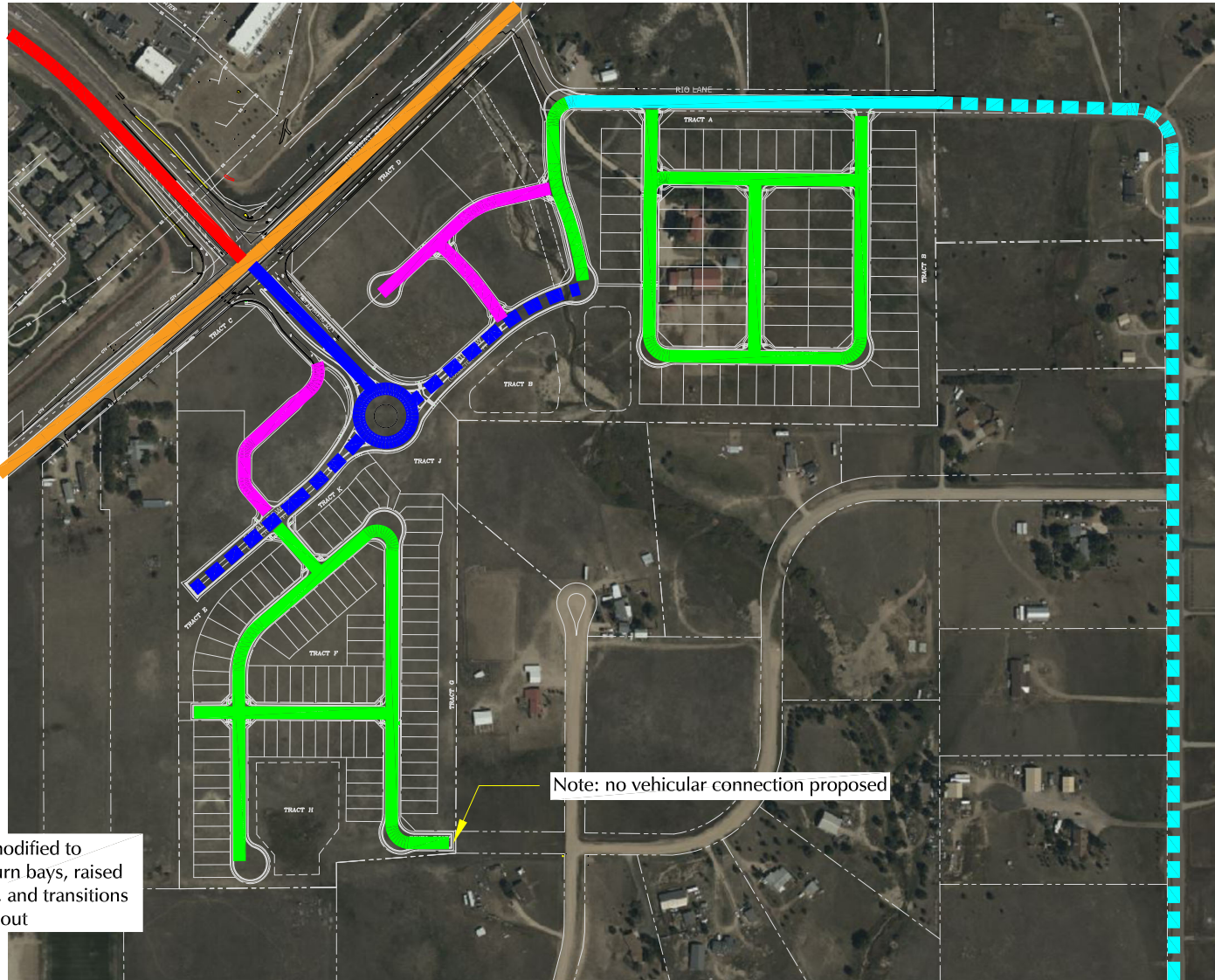

Not to scale

*std. section modified to include right turn bays, raised center median, and transitions to the roundabout

Note: no vehicular connection proposed

LEGEND:

- Urban Non-Residential Collector*
- Urban Local
- Expressway
- Urban Local or County approved alternative
- Urban Local (commercial-private)
- EX - Expressway/Major Bypass (CDOT)
- Urban Non-Residential Collector (with modified cross section)
- Rural Local



Figure 12
Street Classification
 Commons at Falcon Field (LSC# S234220)

AutoTurn Exhibits 1-5

Review 2 comment:
please also provide
snow plow turn
movements.
Review 3: unresolved



LEGEND:

- = Vehicle Body Clearance (1 foot) (Dot)
- = Vehicle Body
- = Front Tires
- = Rear Tires

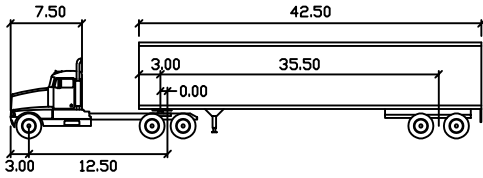

WB-50

	feet	
Tractor Width	: 8.00	Lock to Lock Time : 6.0
Trailer Width	: 8.50	Steering Angle : 17.7
Tractor Track	: 8.00	Articulating Angle : 70.0
Trailer Track	: 8.50	

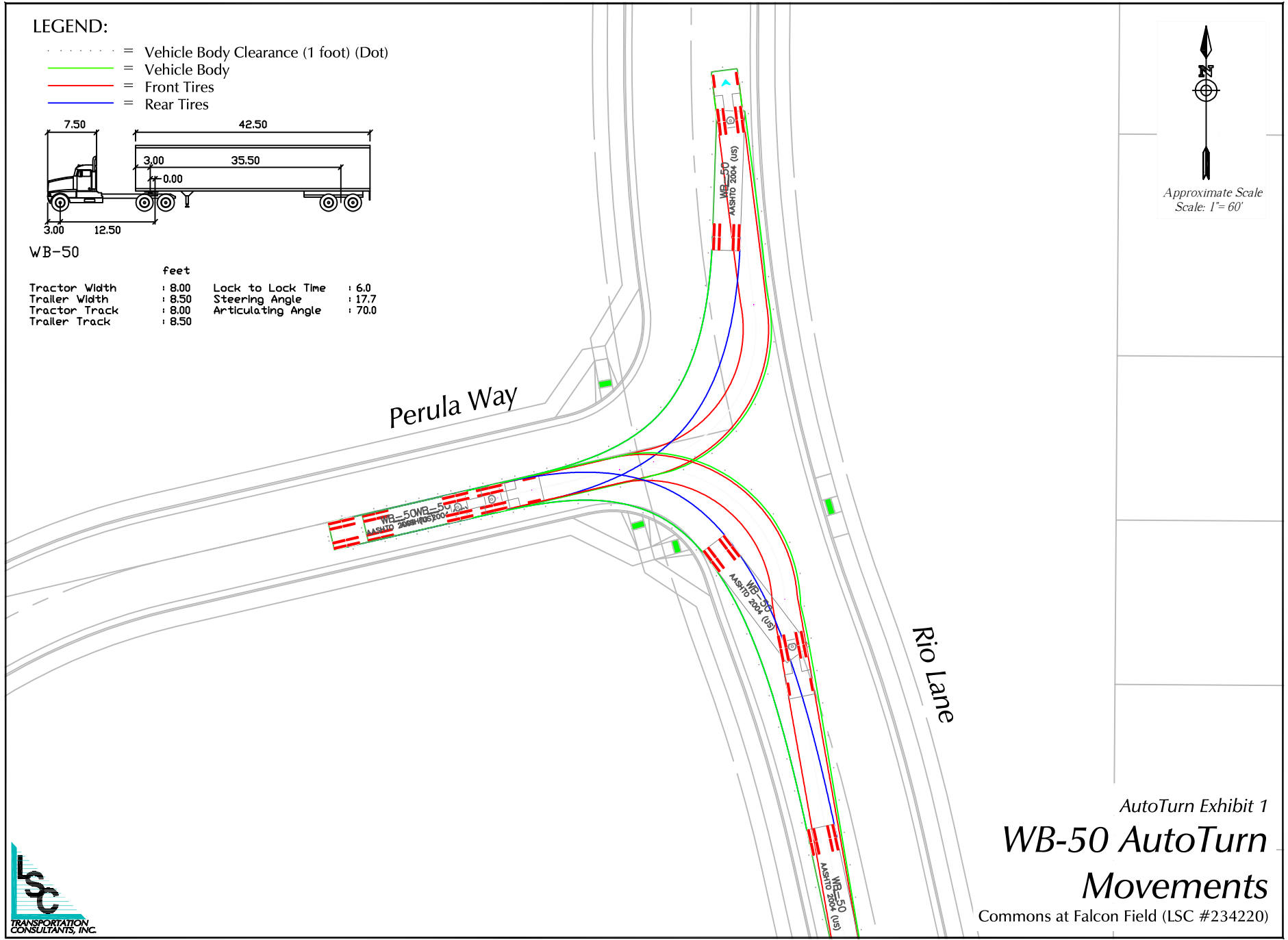
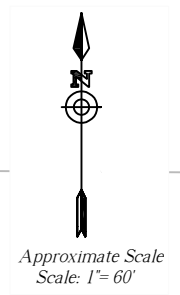

AutoTurn Exhibit 1
WB-50 AutoTurn
Movements
 Commons at Falcon Field (LSC #234220)



LEGEND:

- = Vehicle Body Clearance (1 foot) (Dot)
- = Vehicle Body
- = Front Tires
- = Rear Tires

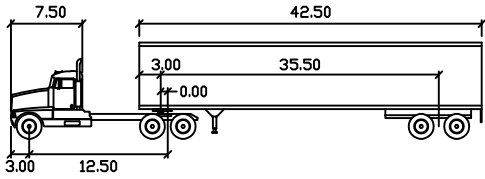

WB-50

	feet	
Tractor Width	: 8.00	Lock to Lock Time : 6.0
Trailer Width	: 8.50	Steering Angle : 17.7
Tractor Track	: 8.00	Articulating Angle : 70.0
Trailer Track	: 8.50	

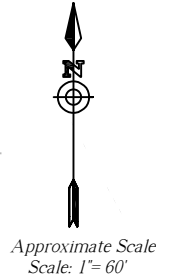

fix as the design
vehicle is
encroaching into the
sidewalk

Retail Row St.

Rio Lane

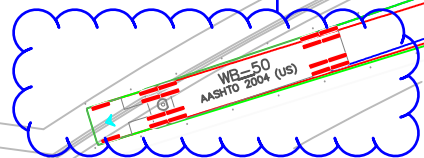

AutoTurn Exhibit 2

WB-50 AutoTurn Movements

Commons at Falcon Field (LSC #234220)



LEGEND:

- = Vehicle Body Clearance (1 foot) (Dot)
- = Vehicle Body
- = Front Tires
- = Rear Tires

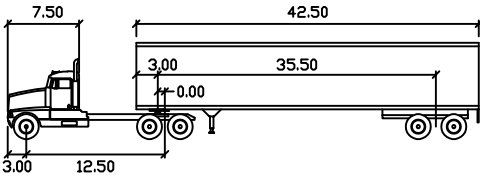

WB-50

	feet	
Tractor Width	: 8.00	Lock to Lock Time : 6.0
Trailer Width	: 8.50	Steering Angle : 17.7
Tractor Track	: 8.00	Articulating Angle : 70.0
Trailer Track	: 8.50	

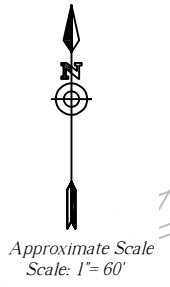

southwest bound right turning design vehicle is shown in the left turn bay. Revise

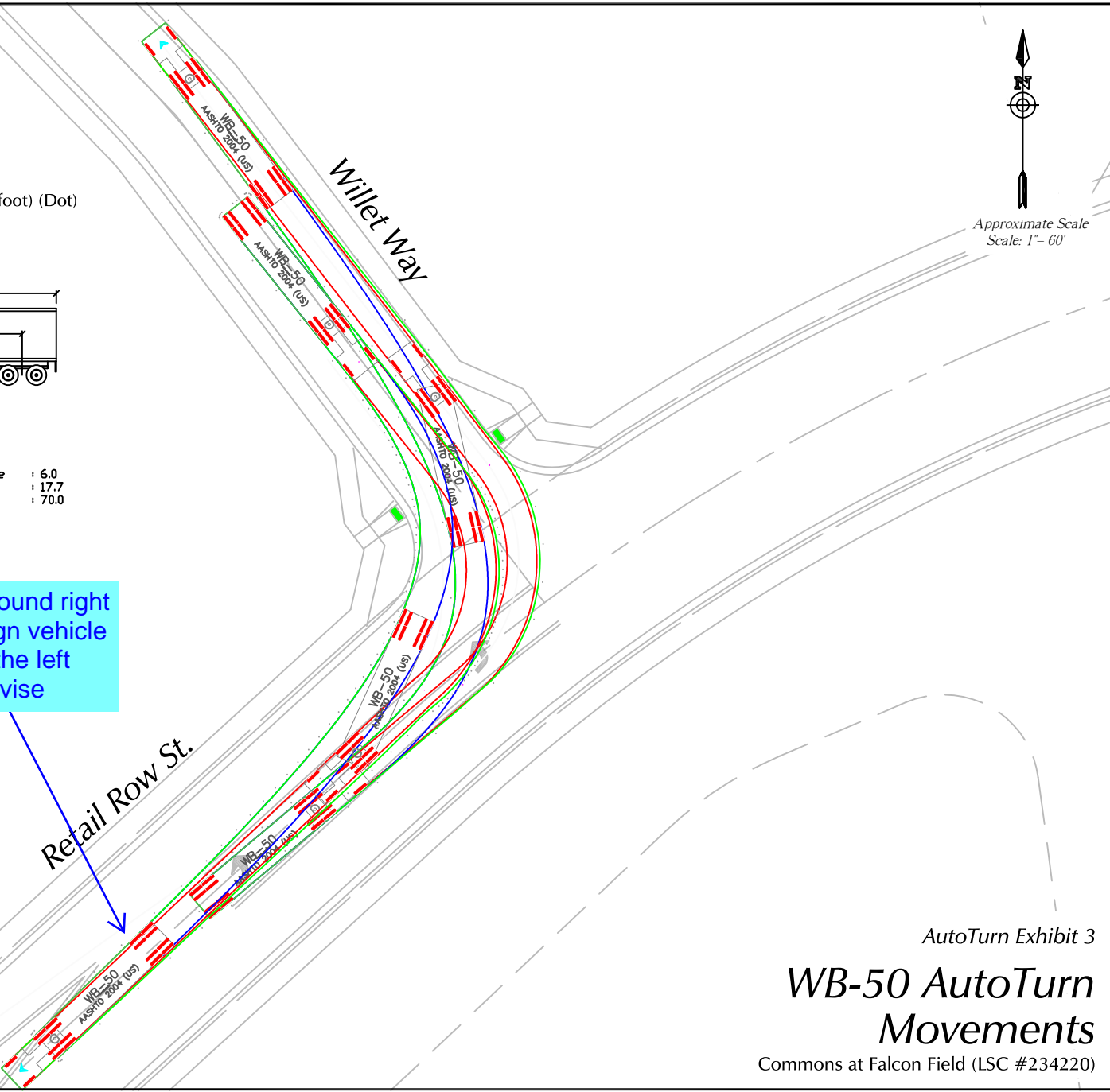



Approximate Scale
Scale: 1" = 60'

LEGEND:

- = Vehicle Body Clearance (1 foot) (Dot)
- = Vehicle Body
- = Front Tires
- = Rear Tires

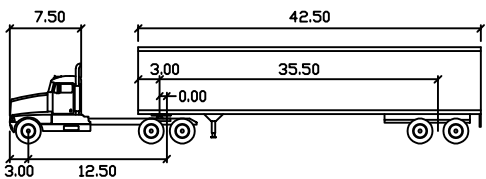

WB-50

	feet		
Tractor Width	: 8.00	Lock to Lock Time	: 6.0
Trailer Width	: 8.50	Steering Angle	: 17.7
Tractor Track	: 8.00	Articulating Angle	: 70.0
Trailer Track	: 8.50		

Dunlin Dr.

Woodmen Rd

AutoTurn Exhibit 4

WB-50 AutoTurn Movements

Commons at Falcon Field (LSC #234220)





Approximate Scale
Scale: 1" = 60'

LEGEND:

- = Vehicle Body Clearance (1 foot) (Dot)
- = Vehicle Body
- = Front Tires
- = Rear Tires

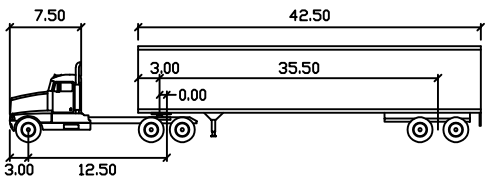

WB-50

	feet	
Tractor Width	: 8.00	Lock to Lock Time : 6.0
Trailer Width	: 8.50	Steering Angle : 17.7
Tractor Track	: 8.00	Articulating Angle : 70.0
Trailer Track	: 8.50	

Retail Row St.

Dunlin Dr.

TRACT

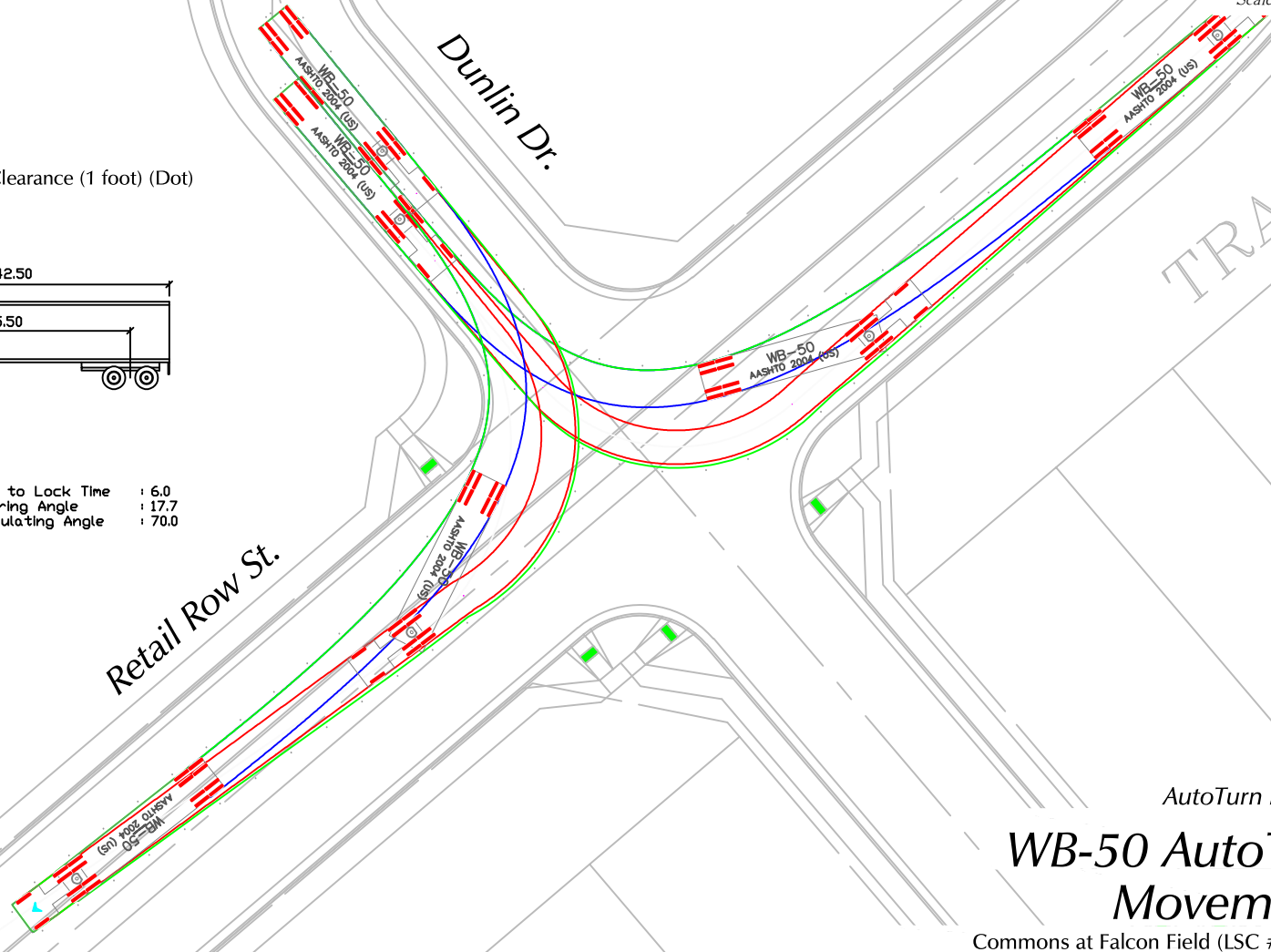

AutoTurn Exhibit 5

WB-50 AutoTurn Movements

Commons at Falcon Field (LSC #234220)



Roundabout Design Parameters Table

PCD File No. SP232
The Commons at Falcon Field
(LSC#S234220)
Woodmen Road & Retail Row Street
County: El Paso

ROUNDAABOUT CRITICAL DESIGN PARAMETERS

DESIGN PARAMETERS	LEG 1	LEG 2	LEG 3	LEG 4	LEG 5	LEG 6
Approach Width, FT	18.0	18.0	18.0			
Entry Width, FT	15.0	15.0	15.0			
Entry Angle, PHI Φ , DEG	14.5	36.0	31.0			
Inscribed Circle Diameter, FT	180.0	180.0	180.0			
Exit Width, FT	23.4	20.0	20.0			
Circulating Roadway Width Upstream of Entry, FT	18.0	18.0	18.0			

FASTEST SPEED PATH

R_1 , Radius/Speed, FT/MPH	135	23	134	22	135	22				
R_2 , Radius/Speed, FT/MPH			107	21	78	18				
R_3 , Radius/Speed, FT/MPH	900	>40	850	>40	345	31				
R_4 , Radius/Speed, FT/MPH	76	18	77	18						
R_5 , Radius/Speed, FT/MPH	130	22			110	21				
Bypass R_5 , Radius/Speed, FT/MPH										

MINIMUM SIGHT PARAMETERS

Approach Design Speed, MPH	40.0	25.0	25.0			
Horizontal Stopping Sight Distance, FT						
Circulating Intersection Sight Distance, FT/MPH						
Entering Intersection Sight Distance, FT/MPH						

Design Vehicle: WB-50, WB-67, EPC snowplow

Truck Apron Width: 10'

OSOW Accommodations: N/A

Circulating Roadway Cross-Slope: 2% or less

Access Control: N/A

Parking Control: No Parking

Bicycle & Pedestrian Accommodations: Ped ramps and sidewalks

per WisDOT criteria
truck apron shall be a
min. 12 ft. wide

Designer: *Matt Romero*
 Reviewer: *Chris McGranahan, P.E., PTOE*

***** Preliminary *****

SIGNATURE: _____

DATE: 3/8/2024

NAME: Christopher S. McGranahan, P.E.

The reviewer's signature on this document indicates that the design has been reviewed and is in general compliance with good roundabout principals. The critical design elements have been addressed. The project design engineer in responsible charge of final plan development will stamp the plans when applicable.

Roundabout Exhibits 1-5





Approximate Scale
Scale: 1" = 1,000'

Roundabout Exhibit 1

Vicinity Map

Falcon Field Preliminary Plan 2023 (LSC #234220)

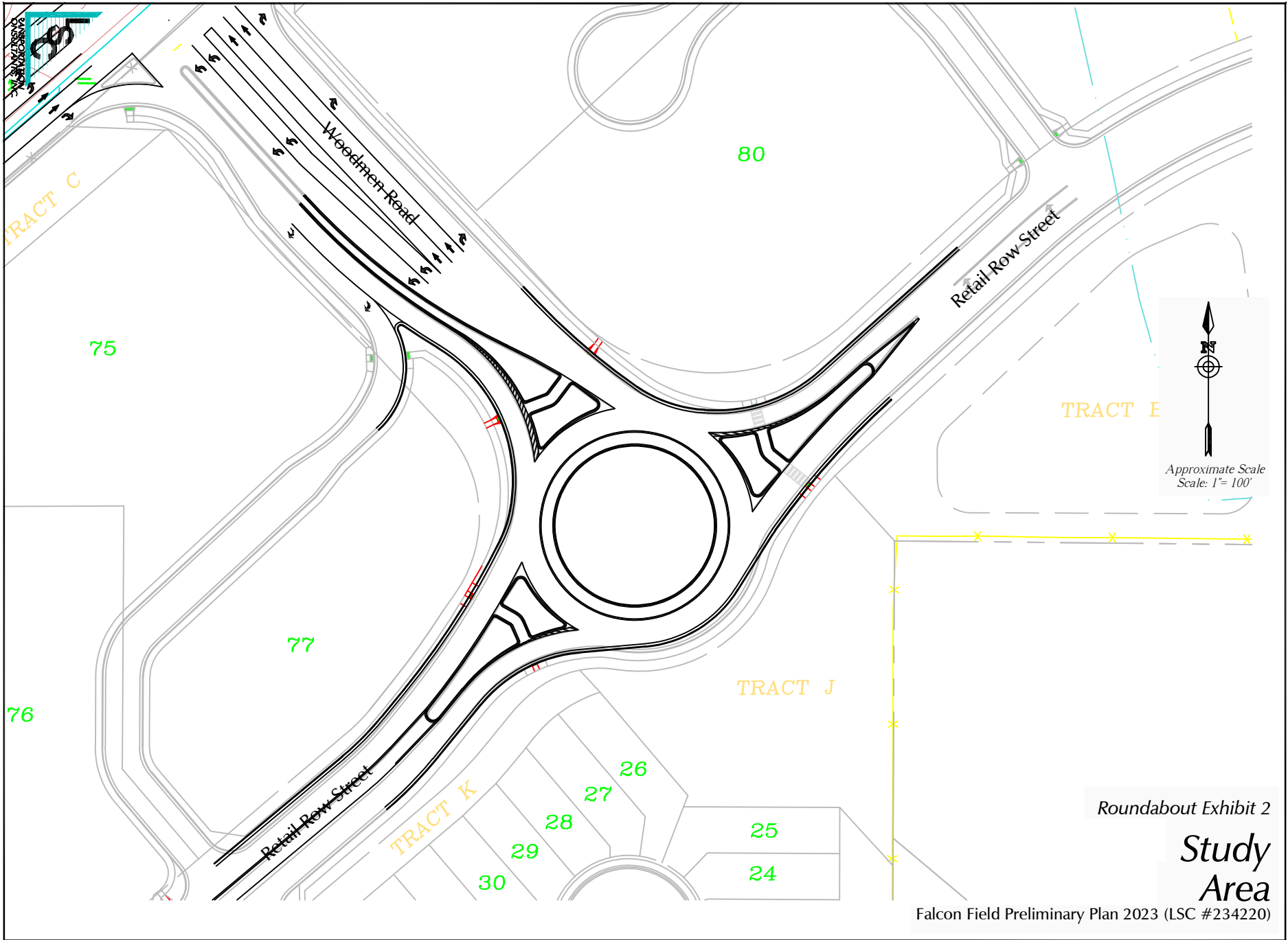

Roundabout Exhibit 2

Study Area

Falcon Field Preliminary Plan 2023 (LSC #234220)

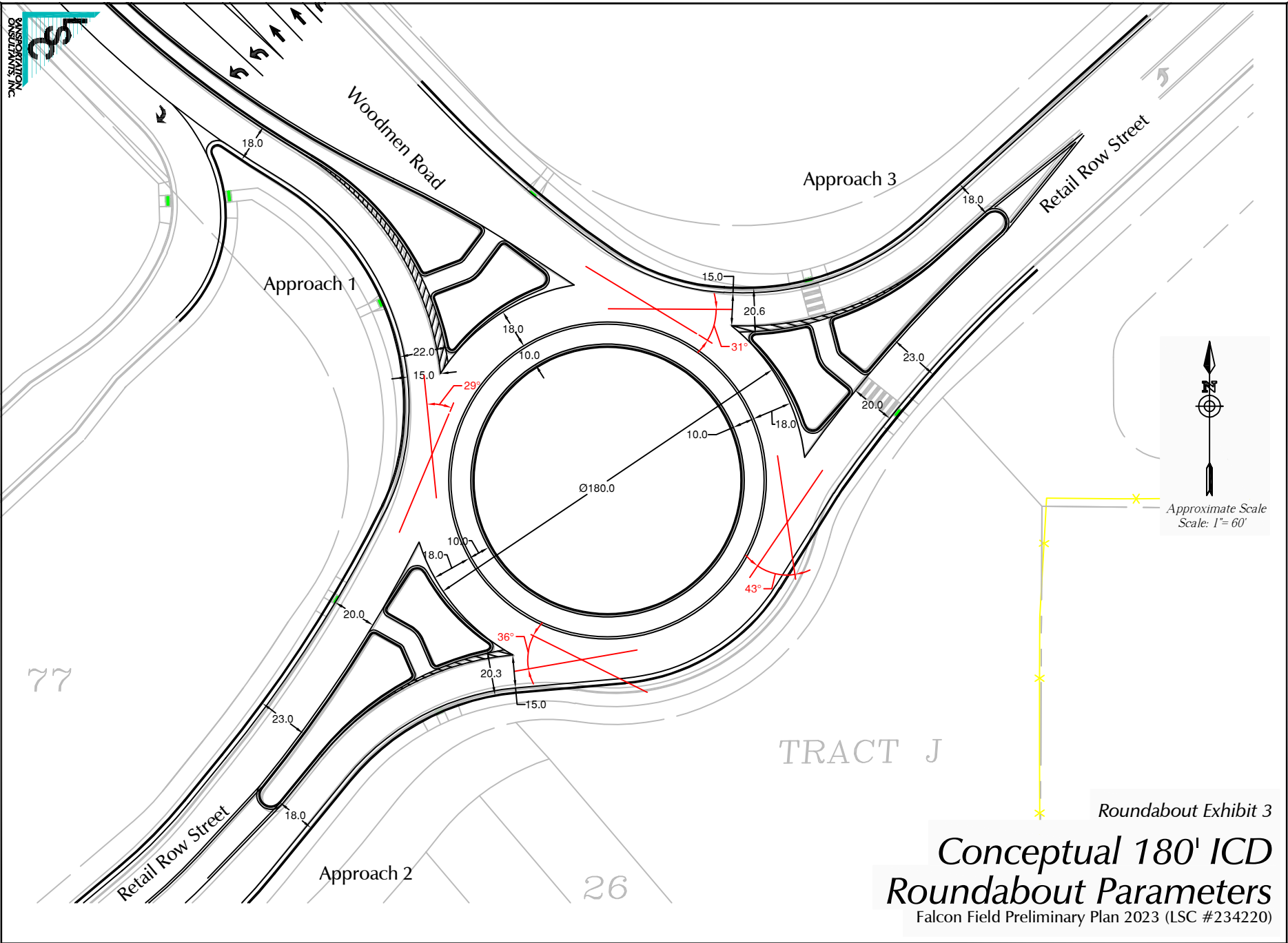

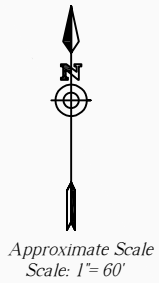
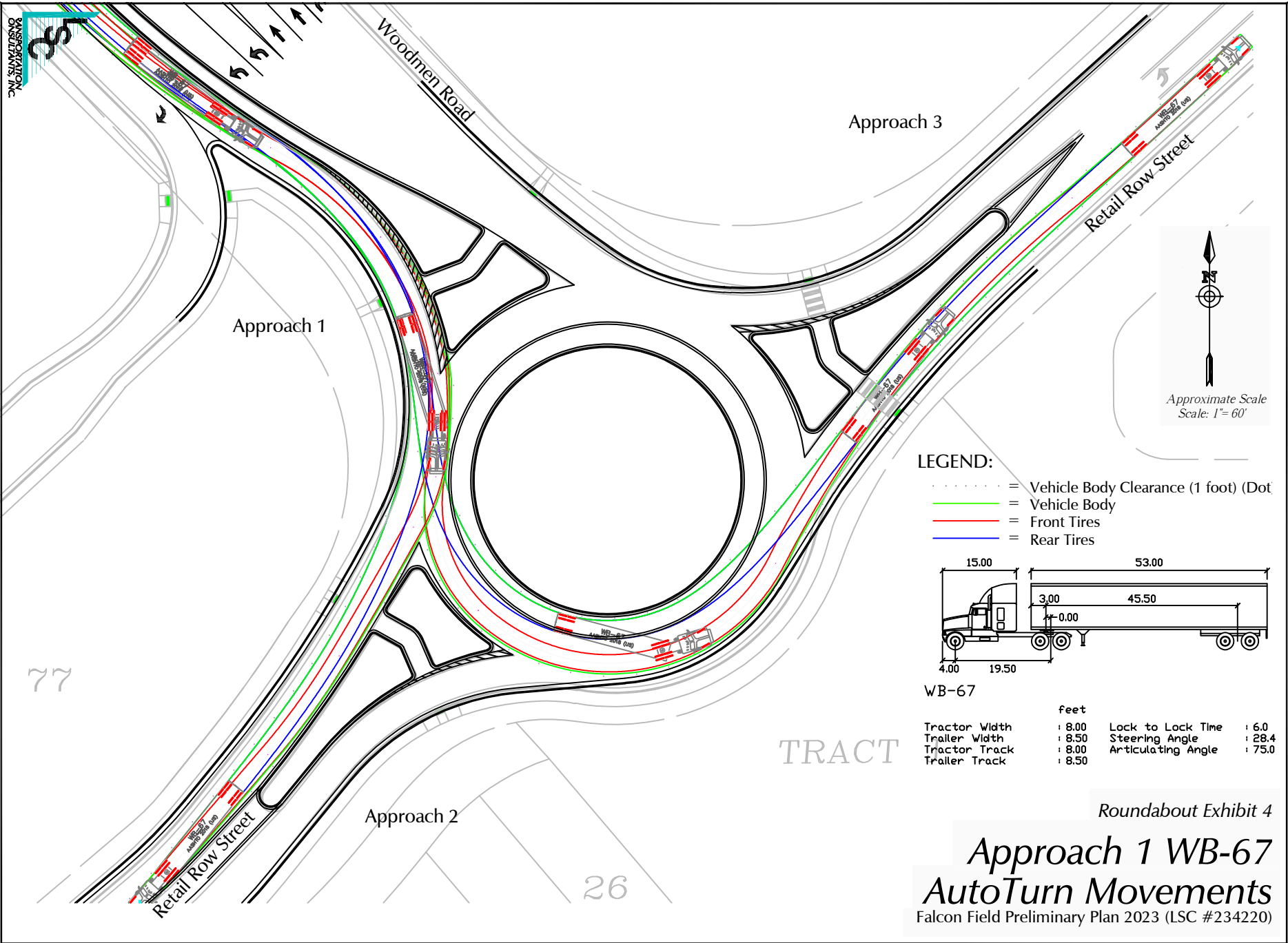

- LEGEND:**
- = Vehicle Body Clearance (1 foot) (Dot)
 - = Vehicle Body
 - = Front Tires
 - = Rear Tires

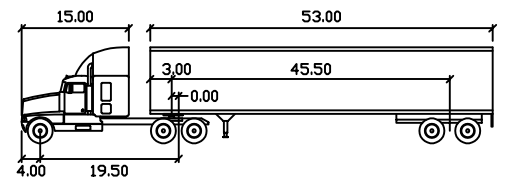

WB-67

	feet		
Tractor Width	: 8.00	Lock to Lock Time	: 6.0
Trailer Width	: 8.50	Steering Angle	: 28.4
Tractor Track	: 8.00	Articulating Angle	: 75.0
Trailer Track	: 8.50		

TRACT

Roundabout Exhibit 4

Approach 1 WB-67 AutoTurn Movements

Falcon Field Preliminary Plan 2023 (LSC #234220)

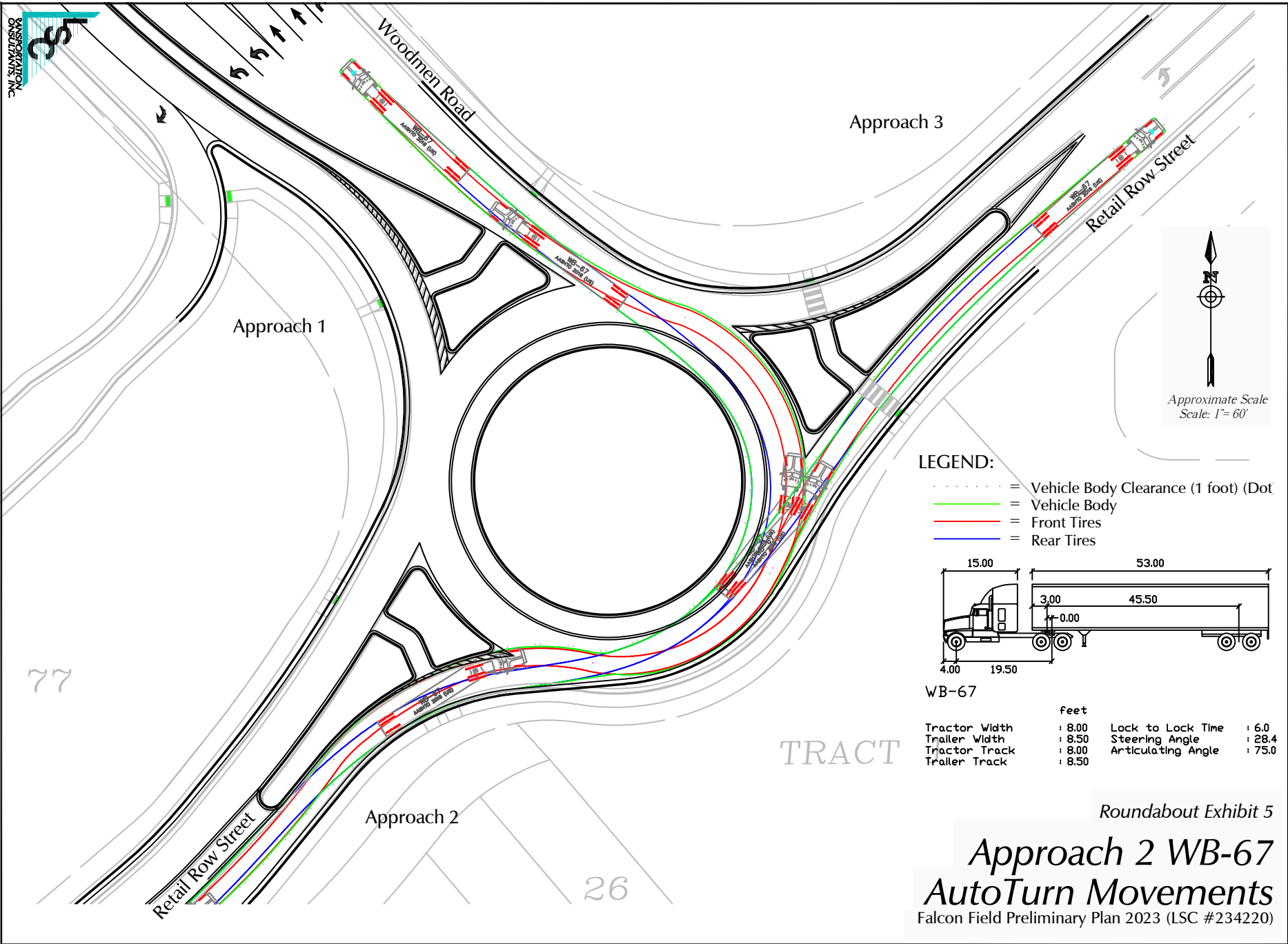

TRANSPORTATION
CONSULTANTS, INC.

LSC

Approach 1

Approach 3

Retail Row Street

Woodmen Road

Approach 2

Retail Row Street

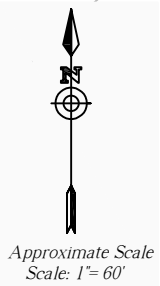

LEGEND:

- = Vehicle Body Clearance (1 foot) (Dot)
- = Vehicle Body
- = Front Tires
- = Rear Tires

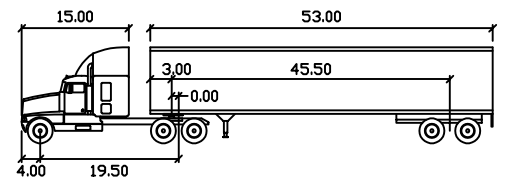

WB-67

	feet		
Tractor Width	: 8.00	Lock to Lock Time	: 6.0
Trailer Width	: 8.50	Steering Angle	: 28.4
Tractor Track	: 8.00	Articulating Angle	: 75.0
Trailer Track	: 8.50		

TRACT

Roundabout Exhibit 5

Approach 2 WB-67
AutoTurn Movements
Falcon Field Preliminary Plan 2023 (LSC #234220)

77

26

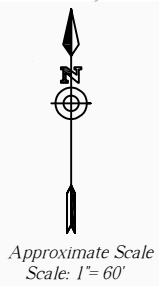
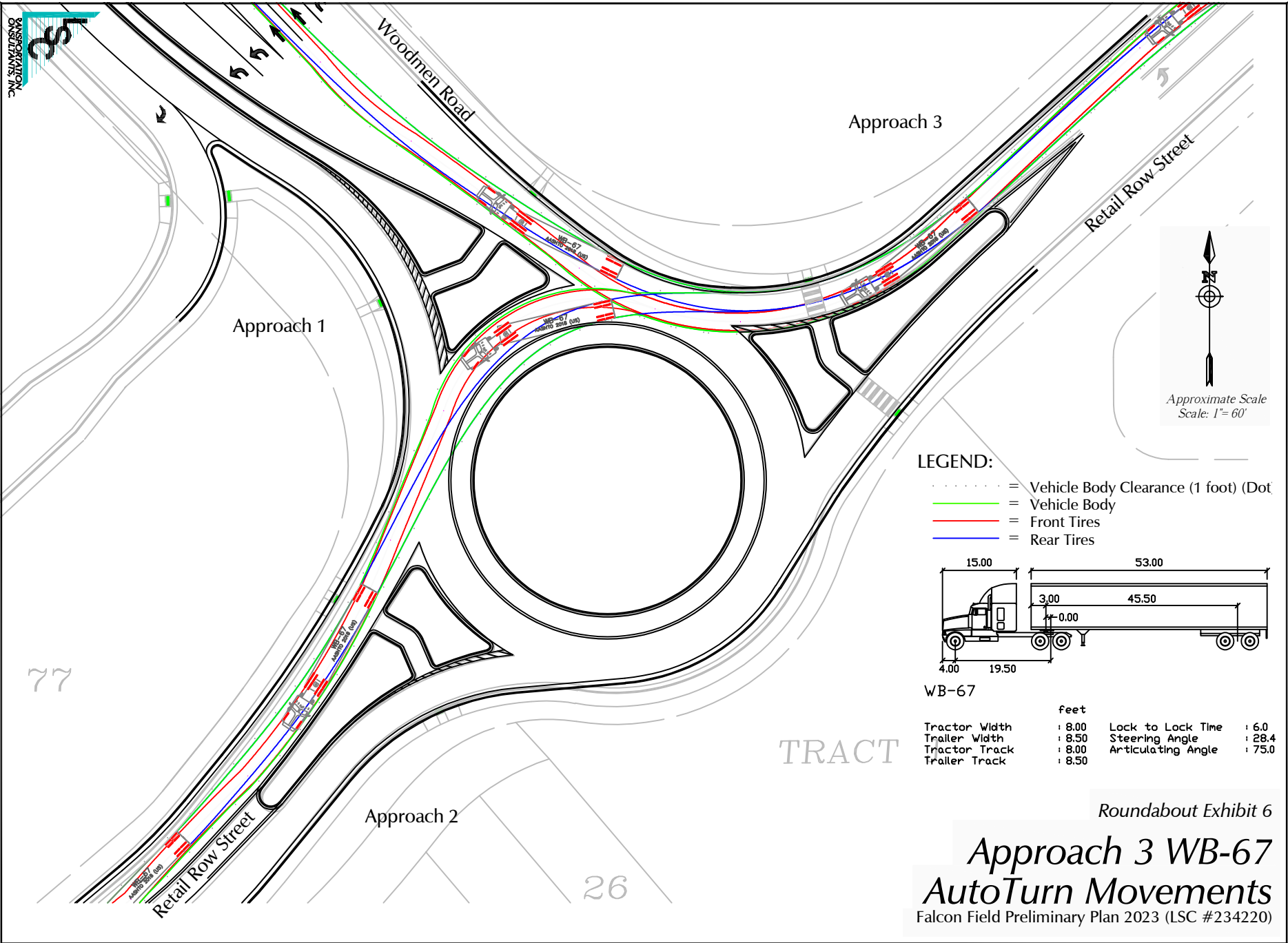

- LEGEND:**
- = Vehicle Body Clearance (1 foot) (Dot)
 - = Vehicle Body
 - = Front Tires
 - = Rear Tires

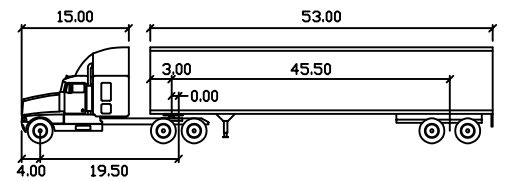

WB-67

	feet		
Tractor Width	: 8.00	Lock to Lock Time	: 6.0
Trailer Width	: 8.50	Steering Angle	: 28.4
Tractor Track	: 8.00	Articulating Angle	: 75.0
Trailer Track	: 8.50		

TRACT

Roundabout Exhibit 6

Approach 3 WB-67
AutoTurn Movements
 Falcon Field Preliminary Plan 2023 (LSC #234220)

77

26

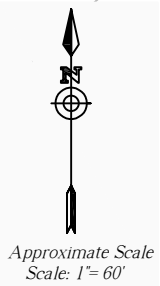
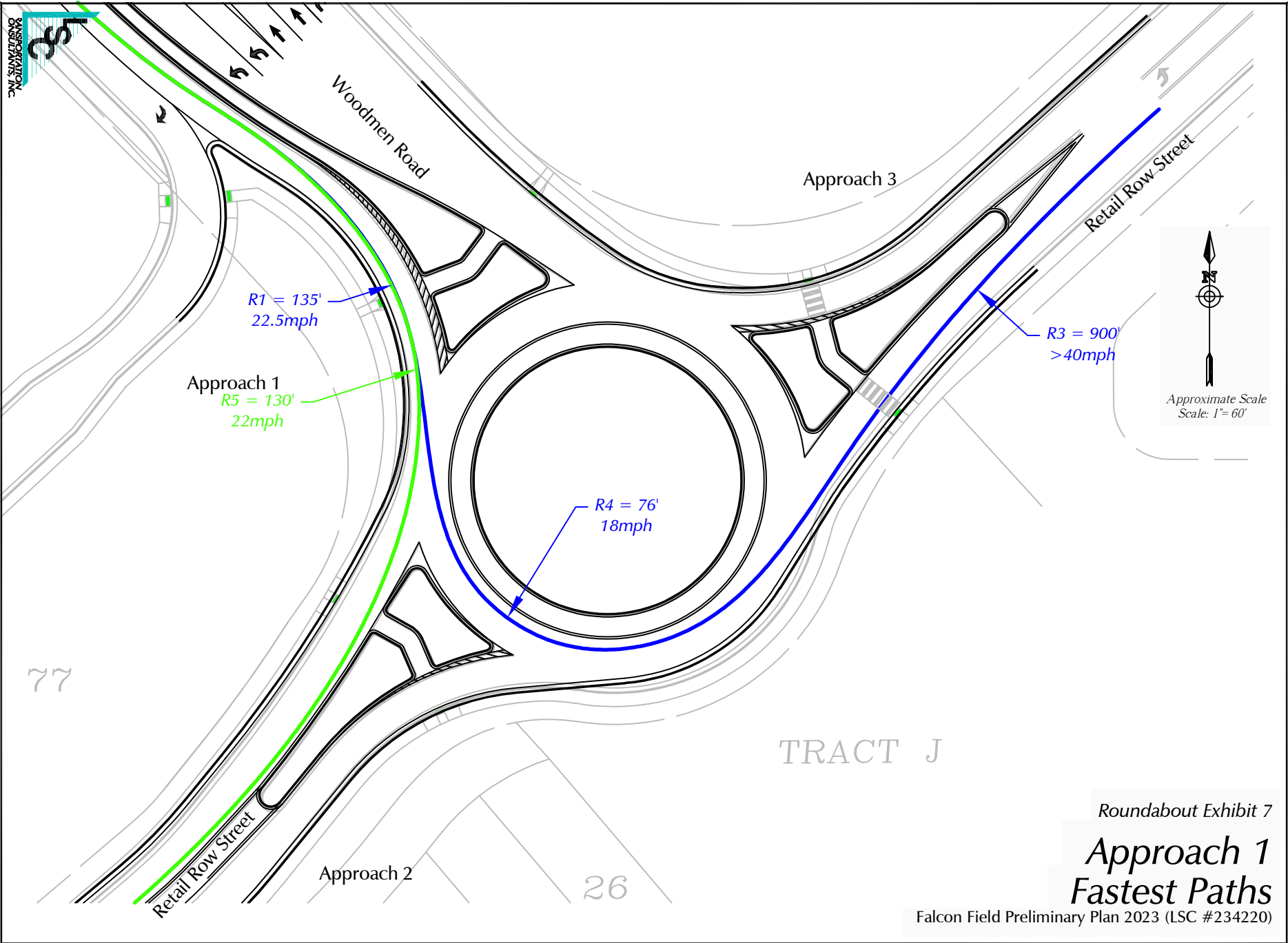

Roundabout Exhibit 7

Approach 1 Fastest Paths

Falcon Field Preliminary Plan 2023 (LSC #234220)

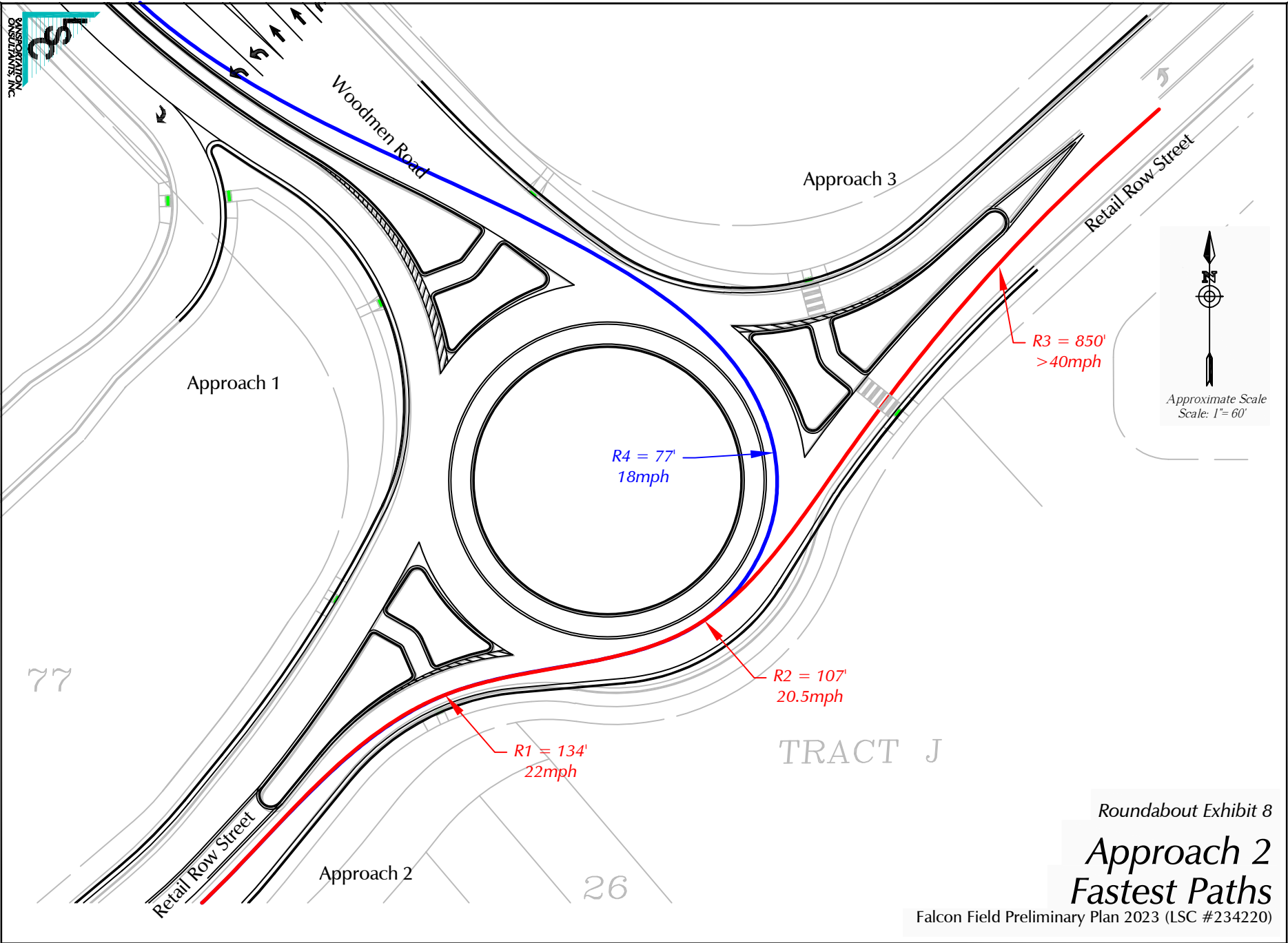

Approach 1

Approach 3

Retail Row Street

R3 = 850'
>40mph

R4 = 77'
18mph

R2 = 107'
20.5mph

R1 = 134'
22mph

TRACT J

77

26

Approach 2

Retail Row Street

Roundabout Exhibit 8

Approach 2 Fastest Paths

Falcon Field Preliminary Plan 2023 (LSC #234220)

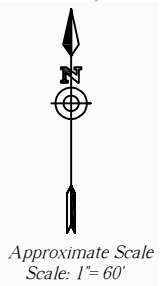
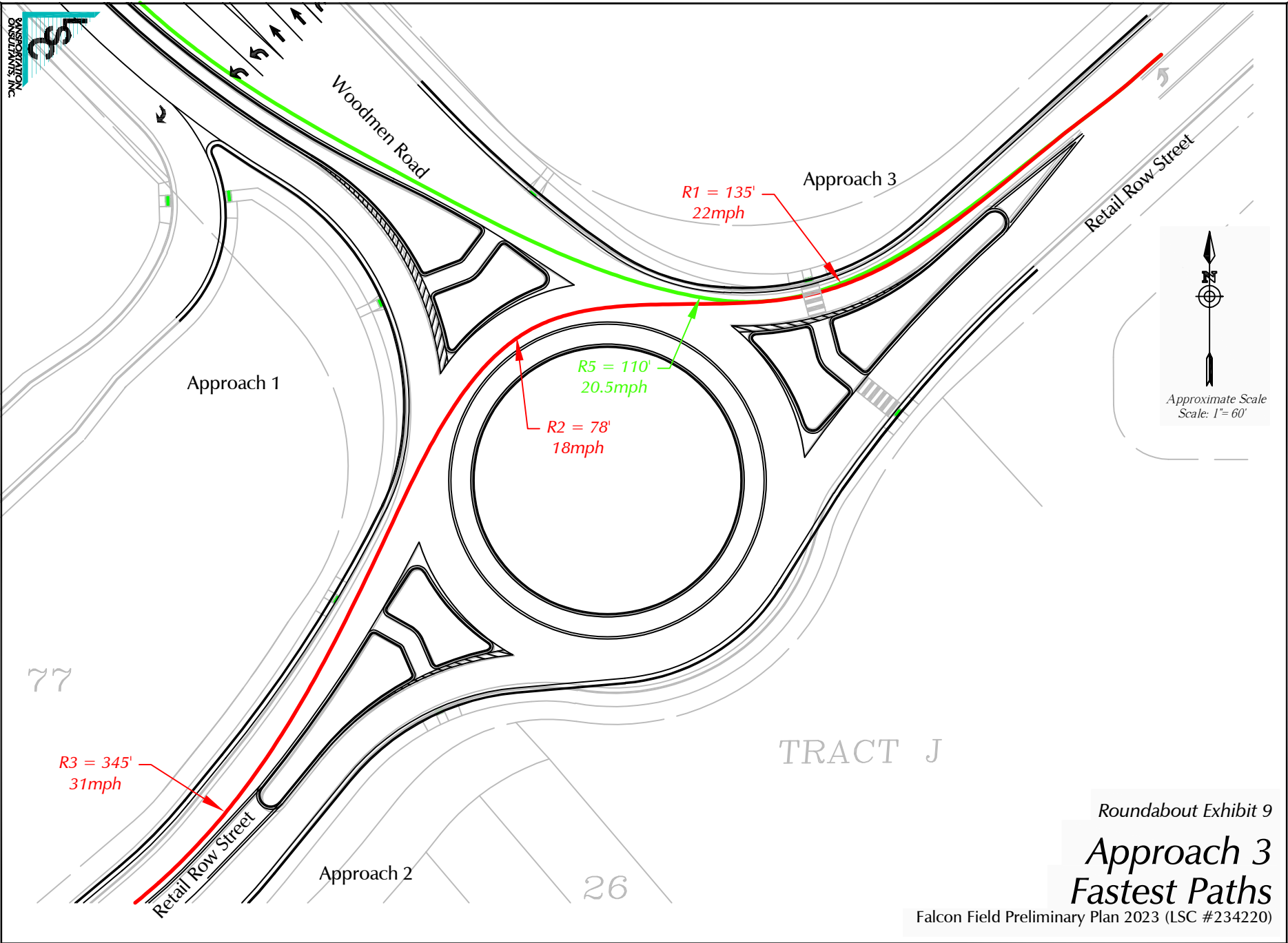

Roundabout Exhibit 9
Approach 3
Fastest Paths
Falcon Field Preliminary Plan 2023 (LSC #234220)

Traffic Counts



LSC Transportation Consultants, Inc.

2504 E. Pikes Peak Ave, Suite 304
 Colorado Springs, CO 80909
 719-633-2868

File Name : Meridian Rd - Woodmen Rd AM 4-23

Site Code : S224050

Start Date : 4/13/2023

Page No : 1

Groups Printed- Unshifted

Start Time	Meridian Rd Southbound					Woodmen Rd Westbound					Meridian Rd Northbound					Woodmen Rd Eastbound					Int. Total
	Right	Thru	Left	Peds	App. Total	Right	Thru	Left	Peds	App. Total	Right	Thru	Left	Peds	App. Total	Right	Thru	Left	Peds	App. Total	
06:30	29	58	2	0	89	1	36	1	0	38	1	8	11	0	20	10	15	13	0	38	185
06:35	34	52	1	0	87	1	48	2	0	51	0	7	10	0	17	9	12	14	1	36	191
06:40	52	79	3	1	135	1	26	1	0	28	1	11	16	0	28	14	17	10	0	41	232
06:45	41	32	1	0	74	3	46	5	0	54	1	8	12	0	21	11	20	27	0	58	207
06:50	47	74	3	0	124	2	33	2	0	37	2	20	9	0	31	20	27	14	0	61	253
06:55	52	52	1	0	105	2	46	9	0	57	0	18	12	0	30	17	22	19	0	58	250
Total	255	347	11	1	614	10	235	20	0	265	5	72	70	0	147	81	113	97	1	292	1318
07:00	44	70	2	0	116	1	24	4	0	29	2	12	17	0	31	14	16	21	0	51	227
07:05	63	39	2	0	104	0	50	4	0	54	2	17	5	0	24	14	20	24	0	58	240
07:10	54	63	6	0	123	4	42	3	0	49	1	20	19	0	40	8	24	27	0	59	271
07:15	43	54	5	0	102	5	44	9	0	58	1	12	11	0	24	22	22	36	0	80	264
07:20	41	51	2	0	94	3	46	4	0	53	2	23	15	0	40	26	22	26	0	74	261
07:25	35	38	2	0	75	5	55	6	0	66	1	27	13	0	41	26	31	32	0	89	271
07:30	37	49	5	0	91	2	47	2	0	51	3	17	14	0	34	17	16	18	0	51	227
07:35	51	41	1	0	93	3	63	7	0	73	0	18	8	0	26	12	18	23	0	53	245
07:40	36	47	3	0	86	3	35	11	0	49	2	16	15	0	33	14	20	35	0	69	237
07:45	38	28	6	0	72	6	66	7	0	79	1	12	4	0	17	11	21	27	0	59	227
07:50	37	37	6	0	80	6	26	11	0	43	1	21	15	0	37	13	19	30	0	62	222
07:55	21	26	2	0	49	5	61	9	0	75	1	23	8	1	33	16	36	36	0	88	245
Total	500	543	42	0	1085	43	559	77	0	679	17	218	144	1	380	193	265	335	0	793	2937
08:00	23	53	6	0	82	2	31	5	0	38	0	19	12	0	31	12	18	24	0	54	205
08:05	23	30	3	0	56	2	47	6	0	55	1	17	13	1	32	10	20	30	0	60	203
08:10	35	42	5	0	82	3	19	6	0	28	0	31	14	0	45	8	30	33	0	71	226
08:15	30	32	6	0	68	5	57	9	0	71	3	20	10	0	33	8	33	20	0	61	233
08:20	31	44	7	0	82	3	41	5	0	49	2	23	19	0	44	7	10	22	0	39	214
08:25	29	32	7	0	68	1	48	14	0	63	3	12	6	0	21	11	24	33	0	68	220
Grand Total	926	1123	87	1	2137	69	1037	142	0	1248	31	412	288	2	733	330	513	594	1	1438	5556
Apprch %	43.3	52.6	4.1	0		5.5	83.1	11.4	0		4.2	56.2	39.3	0.3		22.9	35.7	41.3	0.1		
Total %	16.7	20.2	1.6	0	38.5	1.2	18.7	2.6	0	22.5	0.6	7.4	5.2	0	13.2	5.9	9.2	10.7	0	25.9	

LSC Transportation Consultants, Inc.

2504 E. Pikes Peak Ave, Suite 304
 Colorado Springs, CO 80909
 719-633-2868

File Name : Meridian Rd - Woodmen Rd AM 4-23

Site Code : S224050

Start Date : 4/13/2023

Page No : 2

Start Time	Meridian Rd Southbound					Woodmen Rd Westbound					Meridian Rd Northbound					Woodmen Rd Eastbound					Int. Total
	Right	Thru	Left	Peds	App. Total	Right	Thru	Left	Peds	App. Total	Right	Thru	Left	Peds	App. Total	Right	Thru	Left	Peds	App. Total	
Peak Hour Analysis From 06:30 to 08:25 - Peak 1 of 1																					
Peak Hour for Entire Intersection Begins at 06:50																					
06:50	47	74	3	0	124	2	33	2	0	37	2	20	9	0	31	20	27	14	0	61	253
06:55	52	52	1	0	105	2	46	9	0	57	0	18	12	0	30	17	22	19	0	58	250
07:00	44	70	2	0	116	1	24	4	0	29	2	12	17	0	31	14	16	21	0	51	227
07:05	63	39	2	0	104	0	50	4	0	54	2	17	5	0	24	14	20	24	0	58	240
07:10	54	63	6	0	123	4	42	3	0	49	1	20	19	0	40	8	24	27	0	59	271
07:15	43	54	5	0	102	5	44	9	0	58	1	12	11	0	24	22	22	36	0	80	264
07:20	41	51	2	0	94	3	46	4	0	53	2	23	15	0	40	26	22	26	0	74	261
07:25	35	38	2	0	75	5	55	6	0	66	1	27	13	0	41	26	31	32	0	89	271
07:30	37	49	5	0	91	2	47	2	0	51	3	17	14	0	34	17	16	18	0	51	227
07:35	51	41	1	0	93	3	63	7	0	73	0	18	8	0	26	12	18	23	0	53	245
07:40	36	47	3	0	86	3	35	11	0	49	2	16	15	0	33	14	20	35	0	69	237
07:45	38	28	6	0	72	6	66	7	0	79	1	12	4	0	17	11	21	27	0	59	227
Total Volume	541	606	38	0	1185	36	551	68	0	655	17	212	142	0	371	201	259	302	0	762	2973
% App. Total	45.7	51.1	3.2	0		5.5	84.1	10.4	0		4.6	57.1	38.3	0		26.4	34	39.6	0		
PHF	.716	.682	.528	.000	.796	.500	.696	.515	.000	.691	.472	.654	.623	.000	.754	.644	.696	.699	.000	.713	.914

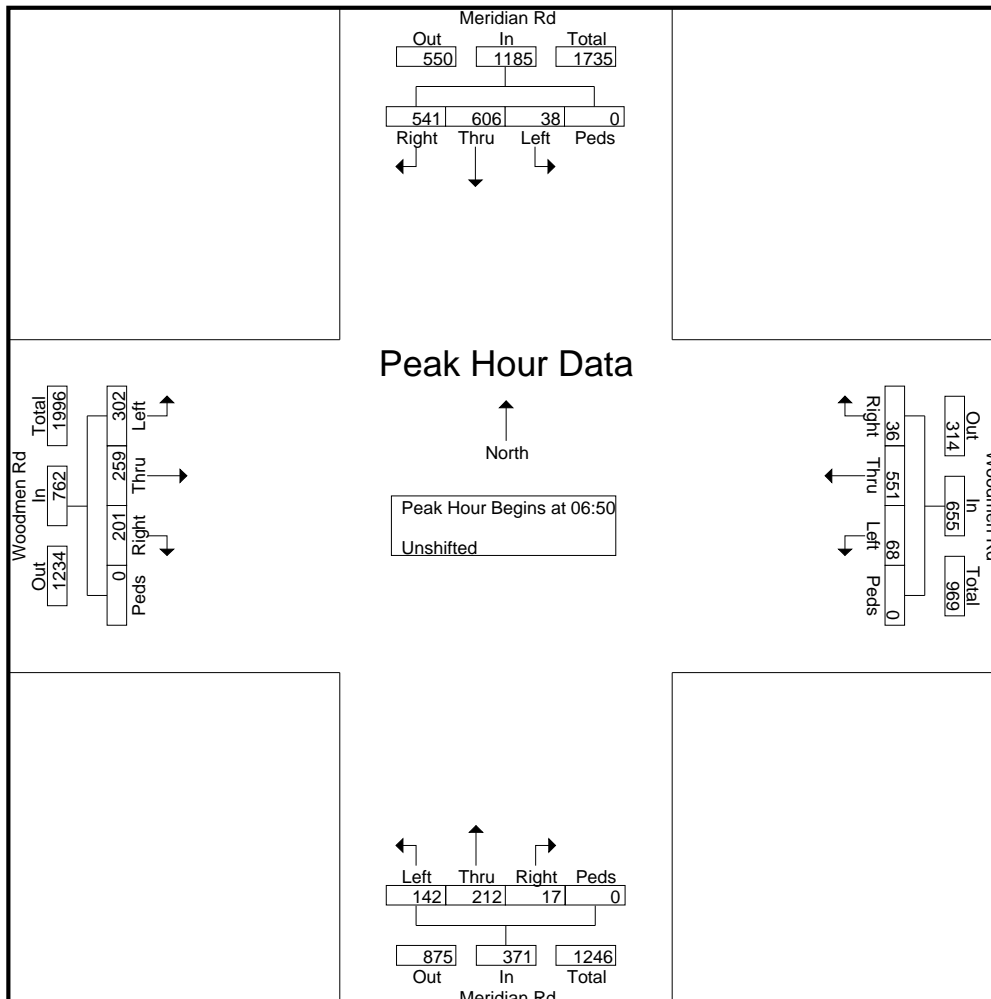

LSC Transportation Consultants, Inc.

2504 E. Pikes Peak Ave, Suite 304
 Colorado Springs, CO 80909
 719-633-2868

File Name : Meridian Rd - Woodmen Rd PM 4-23

Site Code : S224050

Start Date : 4/13/2023

Page No : 1

Groups Printed- Unshifted

Start Time	Meridian Rd Southbound					Woodmen Rd Westbound					Meridian Rd Northbound					Woodmen Rd Eastbound					Int. Total
	Right	Thru	Left	Peds	App. Total	Right	Thru	Left	Peds	App. Total	Right	Thru	Left	Peds	App. Total	Right	Thru	Left	Peds	App. Total	
16:00	22	34	11	0	67	12	35	9	0	56	3	29	10	0	42	6	47	57	0	110	275
16:05	29	49	5	1	84	3	25	4	0	32	10	55	20	0	85	4	40	40	0	84	285
16:10	15	32	8	0	55	2	38	13	0	53	6	28	14	0	48	8	39	55	0	102	258
16:15	25	61	10	0	96	9	22	12	0	43	11	52	24	0	87	8	28	30	0	66	292
16:20	21	21	1	0	43	10	25	9	0	44	9	40	20	0	69	4	52	65	0	121	277
16:25	32	37	10	0	79	2	27	4	0	33	11	51	34	0	96	7	32	47	0	86	294
16:30	15	30	4	0	49	4	28	17	0	49	10	39	19	0	68	8	50	65	0	123	289
16:35	27	34	15	0	76	6	12	21	1	40	9	57	31	0	97	7	24	44	0	75	288
16:40	27	18	5	0	50	4	30	20	0	54	8	47	18	0	73	15	52	58	0	125	302
16:45	28	33	5	0	66	4	18	12	0	34	6	38	29	0	73	11	31	50	0	92	265
16:50	21	29	8	0	58	6	34	6	0	46	8	30	18	0	56	10	47	64	0	121	281
16:55	30	41	16	0	87	5	30	3	0	38	3	51	22	0	76	9	35	42	0	86	287
Total	292	419	98	1	810	67	324	130	1	522	94	517	259	0	870	97	477	617	0	1191	3393
17:00	16	24	6	0	46	5	33	3	0	41	6	40	12	0	58	14	46	76	1	137	282
17:05	22	43	13	0	78	4	37	3	0	44	5	43	24	0	72	11	34	29	0	74	268
17:10	34	29	8	0	71	7	20	31	0	58	4	40	20	0	64	4	43	65	0	112	305
17:15	36	42	8	0	86	2	39	7	0	48	7	39	33	0	79	4	36	46	0	86	299
17:20	32	36	9	0	77	9	39	12	0	60	6	56	13	0	75	5	52	69	0	126	338
17:25	38	30	13	0	81	4	24	10	0	38	9	59	23	0	91	11	31	41	0	83	293
17:30	37	37	6	0	80	3	34	12	0	49	8	51	13	0	72	8	50	34	0	92	293
17:35	31	36	14	0	81	9	18	13	0	40	10	68	20	0	98	10	37	43	0	90	309
17:40	39	31	8	0	78	5	27	6	0	38	8	39	9	0	56	7	54	83	0	144	316
17:45	30	57	10	0	97	5	25	10	0	40	5	52	13	0	70	9	40	46	0	95	302
17:50	29	23	7	0	59	3	31	11	0	45	8	30	5	1	44	14	46	61	0	121	269
17:55	27	41	15	0	83	2	23	9	0	34	8	65	15	0	88	11	17	45	0	73	278
Total	371	429	117	0	917	58	350	127	0	535	84	582	200	1	867	108	486	638	1	1233	3552
Grand Total	663	848	215	1	1727	125	674	257	1	1057	178	1099	459	1	1737	205	963	1255	1	2424	6945
Apprch %	38.4	49.1	12.4	0.1		11.8	63.8	24.3	0.1		10.2	63.3	26.4	0.1		8.5	39.7	51.8	0		
Total %	9.5	12.2	3.1	0	24.9	1.8	9.7	3.7	0	15.2	2.6	15.8	6.6	0	25	3	13.9	18.1	0	34.9	

LSC Transportation Consultants, Inc.

2504 E. Pikes Peak Ave, Suite 304
 Colorado Springs, CO 80909
 719-633-2868

File Name : Meridian Rd - Woodmen Rd PM 4-23

Site Code : S224050

Start Date : 4/13/2023

Page No : 2

Start Time	Meridian Rd Southbound					Woodmen Rd Westbound					Meridian Rd Northbound					Woodmen Rd Eastbound					Int. Total
	Right	Thru	Left	Peds	App. Total	Right	Thru	Left	Peds	App. Total	Right	Thru	Left	Peds	App. Total	Right	Thru	Left	Peds	App. Total	
Peak Hour Analysis From 16:00 to 17:55 - Peak 1 of 1																					
Peak Hour for Entire Intersection Begins at 16:50																					
16:50	21	29	8	0	58	6	34	6	0	46	8	30	18	0	56	10	47	64	0	121	281
16:55	30	41	16	0	87	5	30	3	0	38	3	51	22	0	76	9	35	42	0	86	287
17:00	16	24	6	0	46	5	33	3	0	41	6	40	12	0	58	14	46	76	1	137	282
17:05	22	43	13	0	78	4	37	3	0	44	5	43	24	0	72	11	34	29	0	74	268
17:10	34	29	8	0	71	7	20	31	0	58	4	40	20	0	64	4	43	65	0	112	305
17:15	36	42	8	0	86	2	39	7	0	48	7	39	33	0	79	4	36	46	0	86	299
17:20	32	36	9	0	77	9	39	12	0	60	6	56	13	0	75	5	52	69	0	126	338
17:25	38	30	13	0	81	4	24	10	0	38	9	59	23	0	91	11	31	41	0	83	293
17:30	37	37	6	0	80	3	34	12	0	49	8	51	13	0	72	8	50	34	0	92	293
17:35	31	36	14	0	81	9	18	13	0	40	10	68	20	0	98	10	37	43	0	90	309
17:40	39	31	8	0	78	5	27	6	0	38	8	39	9	0	56	7	54	83	0	144	316
17:45	30	57	10	0	97	5	25	10	0	40	5	52	13	0	70	9	40	46	0	95	302
Total Volume	366	435	119	0	920	64	360	116	0	540	79	568	220	0	867	102	505	638	1	1246	3573
% App. Total	39.8	47.3	12.9	0		11.9	66.7	21.5	0		9.1	65.5	25.4	0		8.2	40.5	51.2	0.1		
PHF	.782	.636	.620	.000	.790	.593	.769	.312	.000	.750	.658	.696	.556	.000	.737	.607	.779	.641	.083	.721	.881

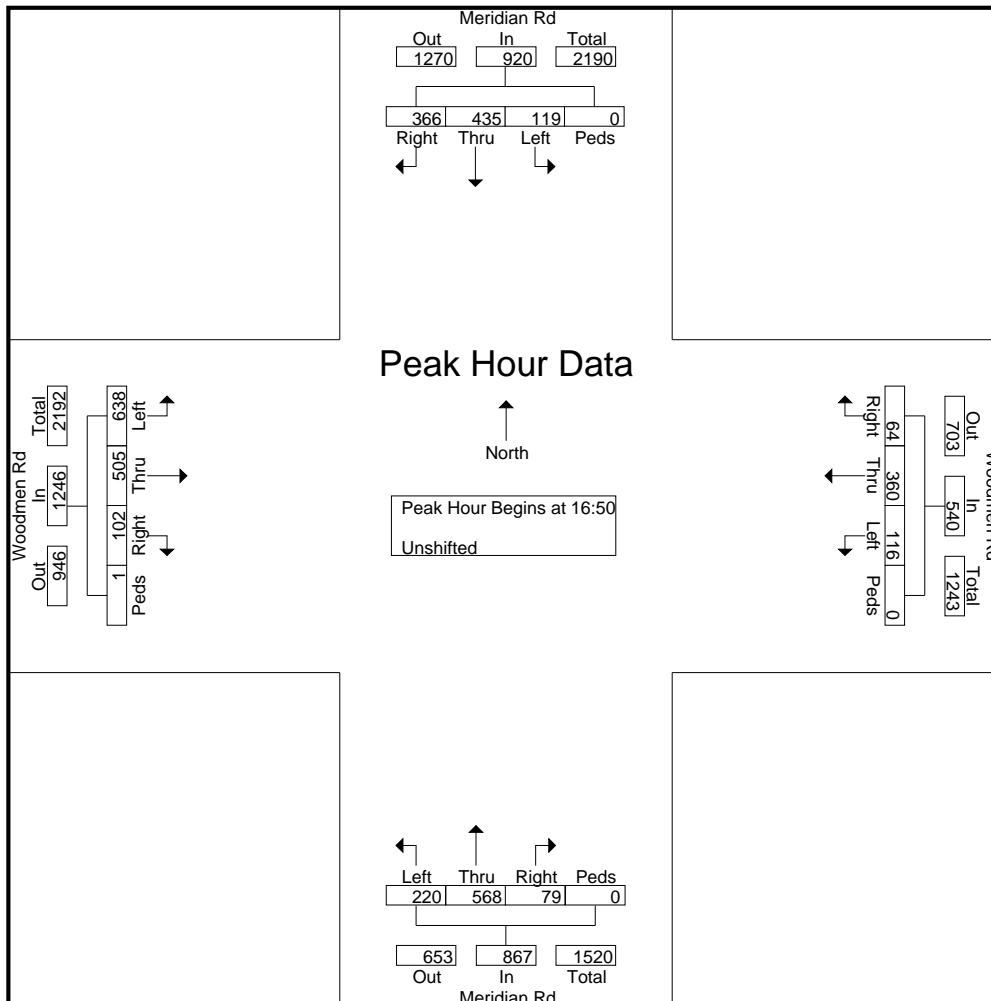

LSC Transportation Consultants, Inc.

2504 E. Pikes Peak Ave, Suite 304
 Colorado Springs, CO 80909
 719-633-2868

File Name : McLaughlin Rd - Woodmen Rd AM 5-23

Site Code : S234220

Start Date : 5/16/2023

Page No : 1

Groups Printed- Unshifted

Start Time	Mclaughlin Rd Southbound					Woodmen Rd Westbound					Mclaughlin Rd Northbound					Woodmen Rd Eastbound					Int. Total
	Right	Thru	Left	Peds	App. Total	Right	Thru	Left	Peds	App. Total	Right	Thru	Left	Peds	App. Total	Right	Thru	Left	Peds	App. Total	
06:30	18	1	12	1	32	7	15	1	0	23	1	1	1	0	3	2	15	1	0	18	76
06:35	7	1	12	0	20	5	26	1	0	32	2	0	1	0	3	1	17	3	0	21	76
06:40	20	2	11	0	33	6	32	0	0	38	2	2	1	0	5	0	13	3	0	16	92
06:45	10	0	8	0	18	8	43	2	0	53	1	4	1	0	6	3	24	7	0	34	111
06:50	20	2	18	0	40	5	30	1	0	36	0	3	4	0	7	0	15	4	0	19	102
06:55	19	3	18	0	40	10	32	4	0	46	2	2	2	0	6	0	23	3	0	26	118
Total	94	9	79	1	183	41	178	9	0	228	8	12	10	0	30	6	107	21	0	134	575
07:00	19	6	20	0	45	8	25	2	0	35	1	1	2	0	4	0	24	3	0	27	111
07:05	30	9	13	0	52	15	26	1	0	42	2	3	3	0	8	2	26	2	0	30	132
07:10	27	10	8	0	45	12	36	1	0	49	1	5	2	0	8	1	26	9	0	36	138
07:15	28	6	13	0	47	9	31	0	0	40	0	2	0	0	2	6	16	5	0	27	116
07:20	20	8	6	0	34	14	40	3	0	57	0	3	3	0	6	1	17	3	1	22	119
07:25	30	13	10	0	53	10	28	4	0	42	1	4	2	0	7	4	21	4	0	29	131
07:30	32	15	5	0	52	7	28	4	1	40	2	4	4	0	10	2	15	7	0	24	126
07:35	30	9	9	0	48	11	25	0	0	36	1	3	5	0	9	3	26	6	0	35	128
07:40	25	11	9	0	45	16	43	3	0	62	0	2	1	0	3	1	14	13	0	28	138
07:45	20	14	17	0	51	9	22	3	0	34	1	8	4	0	13	6	12	8	0	26	124
07:50	19	15	7	0	41	17	20	4	0	41	0	3	5	0	8	5	22	21	0	48	138
07:55	18	8	12	0	38	10	29	3	0	42	0	3	4	0	7	11	17	10	0	38	125
Total	298	124	129	0	551	138	353	28	1	520	9	41	35	0	85	42	236	91	1	370	1526
08:00	14	7	12	0	33	13	21	2	0	36	2	5	6	0	13	4	24	13	0	41	123
08:05	16	11	9	0	36	6	25	1	0	32	3	5	1	0	9	10	25	8	0	43	120
08:10	16	3	9	0	28	17	23	0	0	40	5	4	3	0	12	2	7	7	0	16	96
08:15	15	8	14	0	37	17	26	3	0	46	1	4	3	0	8	4	15	13	0	32	123
08:20	15	3	19	0	37	15	29	2	0	46	1	5	4	0	10	4	16	4	0	24	117
08:25	17	6	16	0	39	10	30	1	0	41	0	4	2	0	6	6	17	6	0	29	115
Grand Total	485	171	287	1	944	257	685	46	1	989	29	80	64	0	173	78	447	163	1	689	2795
Apprch %	51.4	18.1	30.4	0.1		26	69.3	4.7	0.1		16.8	46.2	37	0		11.3	64.9	23.7	0.1		
Total %	17.4	6.1	10.3	0	33.8	9.2	24.5	1.6	0	35.4	1	2.9	2.3	0	6.2	2.8	16	5.8	0	24.7	

LSC Transportation Consultants, Inc.

2504 E. Pikes Peak Ave, Suite 304
 Colorado Springs, CO 80909
 719-633-2868

File Name : McLaughlin Rd - Woodmen Rd AM 5-23

Site Code : S234220

Start Date : 5/16/2023

Page No : 2

Start Time	Mclaughlin Rd Southbound					Woodmen Rd Westbound					Mclaughlin Rd Northbound					Woodmen Rd Eastbound					Int. Total
	Right	Thru	Left	Peds	App. Total	Right	Thru	Left	Peds	App. Total	Right	Thru	Left	Peds	App. Total	Right	Thru	Left	Peds	App. Total	
Peak Hour Analysis From 06:30 to 08:25 - Peak 1 of 1																					
Peak Hour for Entire Intersection Begins at 07:05																					
07:05	30	9	13	0	52	15	26	1	0	42	2	3	3	0	8	2	26	2	0	30	132
07:10	27	10	8	0	45	12	36	1	0	49	1	5	2	0	8	1	26	9	0	36	138
07:15	28	6	13	0	47	9	31	0	0	40	0	2	0	0	2	6	16	5	0	27	116
07:20	20	8	6	0	34	14	40	3	0	57	0	3	3	0	6	1	17	3	1	22	119
07:25	30	13	10	0	53	10	28	4	0	42	1	4	2	0	7	4	21	4	0	29	131
07:30	32	15	5	0	52	7	28	4	1	40	2	4	4	0	10	2	15	7	0	24	126
07:35	30	9	9	0	48	11	25	0	0	36	1	3	5	0	9	3	26	6	0	35	128
07:40	25	11	9	0	45	16	43	3	0	62	0	2	1	0	3	1	14	13	0	28	138
07:45	20	14	17	0	51	9	22	3	0	34	1	8	4	0	13	6	12	8	0	26	124
07:50	19	15	7	0	41	17	20	4	0	41	0	3	5	0	8	5	22	21	0	48	138
07:55	18	8	12	0	38	10	29	3	0	42	0	3	4	0	7	11	17	10	0	38	125
08:00	14	7	12	0	33	13	21	2	0	36	2	5	6	0	13	4	24	13	0	41	123
Total Volume	293	125	121	0	539	143	349	28	1	521	10	45	39	0	94	46	236	101	1	384	1538
% App. Total	54.4	23.2	22.4	0		27.4	67	5.4	0.2		10.6	47.9	41.5	0		12	61.5	26.3	0.3		
PHF	.763	.694	.593	.000	.847	.701	.676	.583	.083	.700	.417	.469	.542	.000	.603	.348	.756	.401	.083	.667	.929

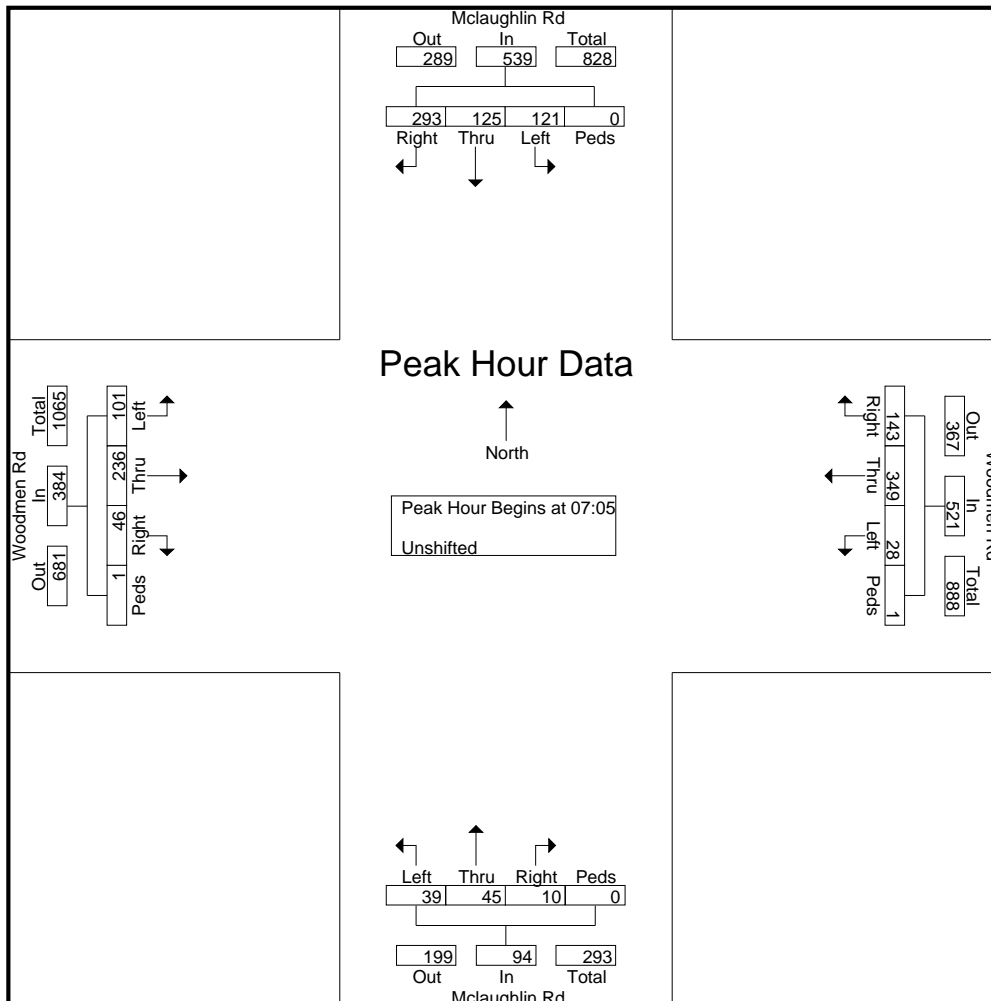

LSC Transportation Consultants, Inc.

2504 E. Pikes Peak Ave, Suite 304
 Colorado Springs, CO 80909
 719-633-2868

File Name : McLaughlin Rd - Woodmen Rd PM 5-23
 Site Code : S234220
 Start Date : 5/16/2023
 Page No : 1

Groups Printed- Unshifted

Start Time	Mclaughlin Rd Southbound					Woodmen Rd Westbound					McLughlin Rd Northbound					Woodmen Rd Eastbound					Int. Total
	Right	Thru	Left	Peds	App. Total	Right	Thru	Left	Peds	App. Total	Right	Thru	Left	Peds	App. Total	Right	Thru	Left	Peds	App. Total	
16:00	9	5	21	0	35	19	26	2	0	47	8	10	6	0	24	12	31	14	0	57	163
16:05	18	13	9	0	40	13	24	3	0	40	6	27	10	0	43	11	24	21	0	56	179
16:10	16	9	15	0	40	28	38	5	0	71	9	10	2	0	21	7	24	37	0	68	200
16:15	17	11	17	0	45	18	26	2	0	46	4	16	7	0	27	8	39	21	0	68	186
16:20	14	11	11	0	36	18	41	7	0	66	11	15	7	0	33	10	24	24	0	58	193
16:25	10	15	22	0	47	28	12	5	0	45	8	14	11	0	33	5	23	24	0	52	177
16:30	24	9	14	2	49	18	33	4	0	55	9	12	6	0	27	8	28	20	0	56	187
16:35	15	8	19	0	42	18	30	4	0	52	11	18	4	0	33	7	42	31	0	80	207
16:40	11	15	20	0	46	25	30	5	0	60	3	12	10	0	25	3	18	19	0	40	171
16:45	7	7	17	0	31	20	38	5	0	63	3	10	5	0	18	8	32	33	0	73	185
16:50	18	8	14	0	40	32	37	2	1	72	8	16	7	0	31	8	28	17	0	53	196
16:55	22	8	10	0	40	21	32	1	0	54	7	14	7	0	28	10	23	24	0	57	179
Total	181	119	189	2	491	258	367	45	1	671	87	174	82	0	343	97	336	285	0	718	2223
17:00	13	4	16	0	33	17	35	2	0	54	9	15	15	0	39	8	16	16	0	40	166
17:05	27	8	10	0	45	23	36	3	0	62	5	13	5	0	23	15	31	30	0	76	206
17:10	26	6	18	0	50	21	18	4	0	43	5	13	16	0	34	6	25	16	1	48	175
17:15	19	9	11	0	39	26	32	4	0	62	1	19	6	0	26	10	34	23	0	67	194
17:20	17	5	14	0	36	17	24	5	0	46	5	6	3	0	14	4	36	20	1	61	157
17:25	19	8	21	0	48	31	37	0	0	68	2	21	7	0	30	11	33	19	0	63	209
17:30	15	6	16	0	37	16	33	2	0	51	10	19	6	0	35	13	37	24	0	74	197
17:35	14	6	19	0	39	17	30	3	0	50	8	19	8	0	35	12	34	24	0	70	194
17:40	12	5	11	0	28	20	21	5	0	46	5	12	9	0	26	7	19	27	0	53	153
17:45	12	7	10	0	29	31	27	4	0	62	2	9	7	0	18	14	40	20	0	74	183
17:50	11	2	12	0	25	18	23	1	0	42	14	12	4	0	30	5	25	19	0	49	146
17:55	12	4	15	0	31	24	27	4	0	55	8	7	4	0	19	13	31	30	0	74	179
Total	197	70	173	0	440	261	343	37	0	641	74	165	90	0	329	118	361	268	2	749	2159
Grand Total	378	189	362	2	931	519	710	82	1	1312	161	339	172	0	672	215	697	553	2	1467	4382
Apprch %	40.6	20.3	38.9	0.2		39.6	54.1	6.2	0.1		24	50.4	25.6	0		14.7	47.5	37.7	0.1		
Total %	8.6	4.3	8.3	0	21.2	11.8	16.2	1.9	0	29.9	3.7	7.7	3.9	0	15.3	4.9	15.9	12.6	0	33.5	

LSC Transportation Consultants, Inc.

2504 E. Pikes Peak Ave, Suite 304
 Colorado Springs, CO 80909
 719-633-2868

File Name : McLaughlin Rd - Woodmen Rd PM 5-23
 Site Code : S234220
 Start Date : 5/16/2023
 Page No : 2

Start Time	McLaughlin Rd Southbound					Woodmen Rd Westbound					McLughlin Rd Northbound					Woodmen Rd Eastbound					Int. Total
	Right	Thru	Left	Peds	App. Total	Right	Thru	Left	Peds	App. Total	Right	Thru	Left	Peds	App. Total	Right	Thru	Left	Peds	App. Total	
Peak Hour Analysis From 16:00 to 17:55 - Peak 1 of 1																					
Peak Hour for Entire Intersection Begins at 16:10																					
16:10	16	9	15	0	40	28	38	5	0	71	9	10	2	0	21	7	24	37	0	68	200
16:15	17	11	17	0	45	18	26	2	0	46	4	16	7	0	27	8	39	21	0	68	186
16:20	14	11	11	0	36	18	41	7	0	66	11	15	7	0	33	10	24	24	0	58	193
16:25	10	15	22	0	47	28	12	5	0	45	8	14	11	0	33	5	23	24	0	52	177
16:30	24	9	14	2	49	18	33	4	0	55	9	12	6	0	27	8	28	20	0	56	187
16:35	15	8	19	0	42	18	30	4	0	52	11	18	4	0	33	7	42	31	0	80	207
16:40	11	15	20	0	46	25	30	5	0	60	3	12	10	0	25	3	18	19	0	40	171
16:45	7	7	17	0	31	20	38	5	0	63	3	10	5	0	18	8	32	33	0	73	185
16:50	18	8	14	0	40	32	37	2	1	72	8	16	7	0	31	8	28	17	0	53	196
16:55	22	8	10	0	40	21	32	1	0	54	7	14	7	0	28	10	23	24	0	57	179
17:00	13	4	16	0	33	17	35	2	0	54	9	15	15	0	39	8	16	16	0	40	166
17:05	27	8	10	0	45	23	36	3	0	62	5	13	5	0	23	15	31	30	0	76	206
Total Volume	194	113	185	2	494	266	388	45	1	700	87	165	86	0	338	97	328	296	0	721	2253
% App. Total	39.3	22.9	37.4	0.4		38	55.4	6.4	0.1		25.7	48.8	25.4	0		13.5	45.5	41.1	0		
PHF	.599	.628	.701	.083	.840	.693	.789	.536	.083	.810	.659	.764	.478	.000	.722	.539	.651	.667	.000	.751	.907

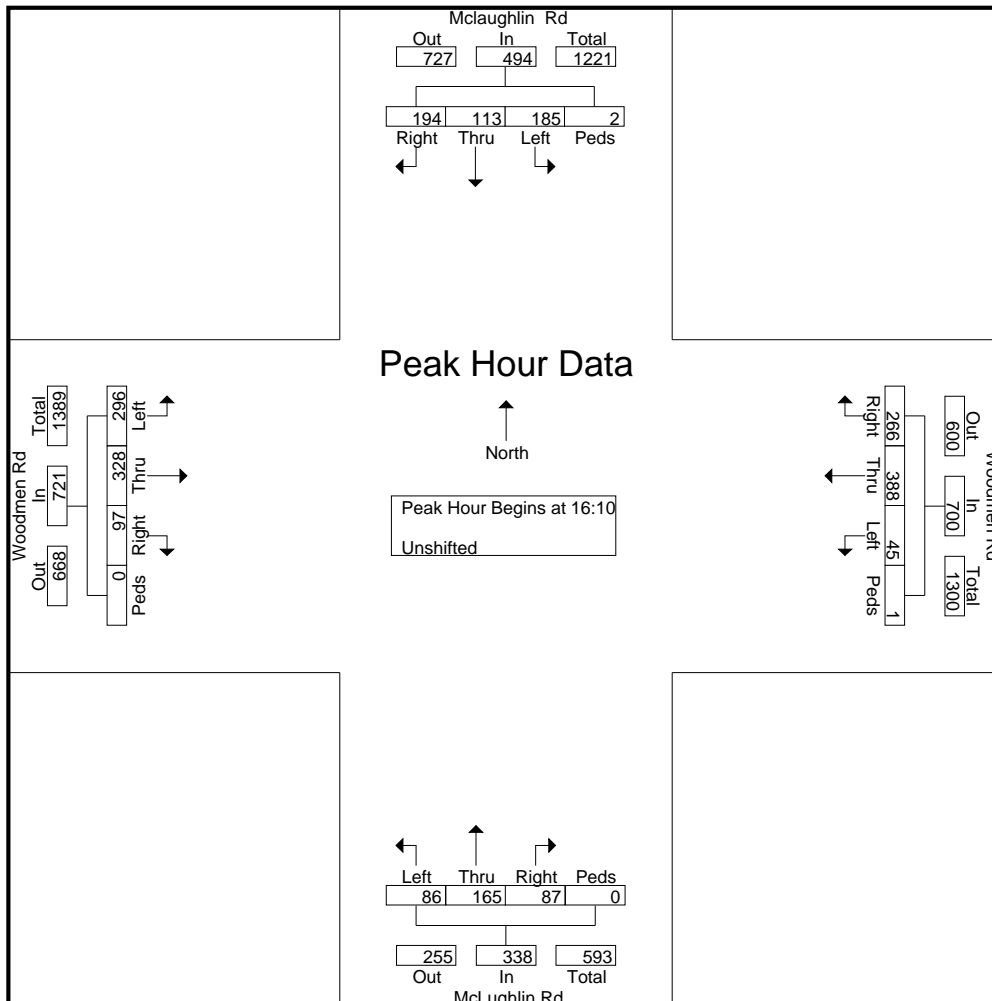

LSC Transportation Consultants, Inc.

2504 E. Pikes Peak Ave, Suite 304
 Colorado Springs, CO 80909
 719-633-2868

File Name : Hwy 24 - Woodmen Rd AM 5-23

Site Code : S214730

Start Date : 5/2/2023

Page No : 1

Groups Printed- Unshifted

Start Time	Hwy 24 Southbound					Westbound					Hwy 24 Northbound					Woodmen Rd Eastbound					Int. Total
	Right	Thru	Left	Peds	App. Total	Right	Thru	Left	Peds	App. Total	Right	Thru	Left	Peds	App. Total	Right	Thru	Left	Peds	App. Total	
06:30	36	45	0	0	81	0	0	0	0	0	0	16	15	0	31	14	0	9	0	23	135
06:35	29	50	0	0	79	0	0	0	0	0	0	27	5	0	32	7	0	12	0	19	130
06:40	39	53	0	0	92	0	0	0	0	0	0	24	5	0	29	14	0	15	0	29	150
06:45	36	54	0	0	90	0	0	0	0	0	0	24	12	0	36	12	0	20	0	32	158
06:50	19	46	9	0	74	0	0	0	0	0	0	14	4	0	18	16	0	27	0	43	135
06:55	20	40	0	0	60	0	0	0	0	0	0	17	11	0	28	12	0	21	0	33	121
Total	179	288	9	0	476	0	0	0	0	0	0	122	52	0	174	75	0	104	0	179	829
07:00	27	50	0	0	77	0	0	0	0	0	0	15	6	0	21	18	0	26	0	44	142
07:05	25	42	0	0	67	0	0	0	0	0	0	25	9	0	34	17	0	20	0	37	138
07:10	25	52	0	0	77	0	0	0	0	0	0	23	12	0	35	8	0	26	0	34	146
07:15	34	48	0	0	82	0	0	0	0	0	0	23	10	0	33	15	0	13	0	28	143
07:20	30	39	0	0	69	0	0	0	0	0	0	21	11	0	32	10	1	17	0	28	129
07:25	28	32	0	1	61	0	0	0	0	0	0	19	11	0	30	9	0	19	0	28	119
07:30	29	36	0	0	65	0	0	0	0	0	0	20	18	0	38	12	0	22	0	34	137
07:35	34	29	0	0	63	0	0	0	0	0	0	22	17	0	39	8	0	12	0	20	122
07:40	39	37	0	0	76	0	0	0	0	0	0	16	14	0	30	10	0	20	0	30	136
07:45	29	31	0	0	60	0	0	0	0	0	0	13	10	0	23	13	0	22	0	35	118
07:50	36	40	0	0	76	0	0	0	0	0	0	22	10	0	32	9	0	19	0	28	136
07:55	29	28	0	0	57	0	0	0	0	0	0	14	22	0	36	8	0	19	0	27	120
Total	365	464	0	1	830	0	0	0	0	0	0	233	150	0	383	137	1	235	0	373	1586
08:00	24	29	0	0	53	0	0	0	0	0	0	16	14	0	30	10	0	28	0	38	121
08:05	30	27	0	0	57	0	0	0	0	0	0	15	10	0	25	5	0	18	0	23	105
08:10	27	37	0	0	64	0	0	0	0	0	0	19	10	0	29	11	0	13	0	24	117
08:15	32	40	0	0	72	0	0	0	0	0	0	18	9	0	27	12	0	24	0	36	135
08:20	25	44	0	0	69	0	0	0	0	0	0	17	10	0	27	13	0	24	0	37	133
08:25	29	33	0	0	62	0	0	0	0	0	0	16	12	0	28	13	0	13	0	26	116
Grand Total	711	962	9	1	1683	0	0	0	0	0	0	456	267	0	723	276	1	459	0	736	3142
Apprch %	42.2	57.2	0.5	0.1		0	0	0	0	0	0	63.1	36.9	0		37.5	0.1	62.4	0		
Total %	22.6	30.6	0.3	0	53.6	0	0	0	0	0	0	14.5	8.5	0	23	8.8	0	14.6	0	23.4	

LSC Transportation Consultants, Inc.

2504 E. Pikes Peak Ave, Suite 304
 Colorado Springs, CO 80909
 719-633-2868

File Name : Hwy 24 - Woodmen Rd AM 5-23

Site Code : S214730

Start Date : 5/2/2023

Page No : 2

Start Time	Hwy 24 Southbound					Westbound					Hwy 24 Northbound					Woodmen Rd Eastbound					Int. Total
	Right	Thru	Left	Peds	App. Total	Right	Thru	Left	Peds	App. Total	Right	Thru	Left	Peds	App. Total	Right	Thru	Left	Peds	App. Total	
Peak Hour Analysis From 06:30 to 08:25 - Peak 1 of 1																					
Peak Hour for Entire Intersection Begins at 06:35																					
06:35	29	50	0	0	79	0	0	0	0	0	0	27	5	0	32	7	0	12	0	19	130
06:40	39	53	0	0	92	0	0	0	0	0	0	24	5	0	29	14	0	15	0	29	150
06:45	36	54	0	0	90	0	0	0	0	0	0	24	12	0	36	12	0	20	0	32	158
06:50	19	46	9	0	74	0	0	0	0	0	0	14	4	0	18	16	0	27	0	43	135
06:55	20	40	0	0	60	0	0	0	0	0	0	17	11	0	28	12	0	21	0	33	121
07:00	27	50	0	0	77	0	0	0	0	0	0	15	6	0	21	18	0	26	0	44	142
07:05	25	42	0	0	67	0	0	0	0	0	0	25	9	0	34	17	0	20	0	37	138
07:10	25	52	0	0	77	0	0	0	0	0	0	23	12	0	35	8	0	26	0	34	146
07:15	34	48	0	0	82	0	0	0	0	0	0	23	10	0	33	15	0	13	0	28	143
07:20	30	39	0	0	69	0	0	0	0	0	0	21	11	0	32	10	1	17	0	28	129
07:25	28	32	0	1	61	0	0	0	0	0	0	19	11	0	30	9	0	19	0	28	119
07:30	29	36	0	0	65	0	0	0	0	0	0	20	18	0	38	12	0	22	0	34	137
Total Volume	341	542	9	1	893	0	0	0	0	0	0	252	114	0	366	150	1	238	0	389	1648
% App. Total	38.2	60.7	1	0.1		0	0	0	0		0	68.9	31.1	0		38.6	0.3	61.2	0		
PHF	.729	.836	.083	.083	.809	.000	.000	.000	.000	.000	.000	.778	.528	.000	.803	.694	.083	.735	.000	.737	.869

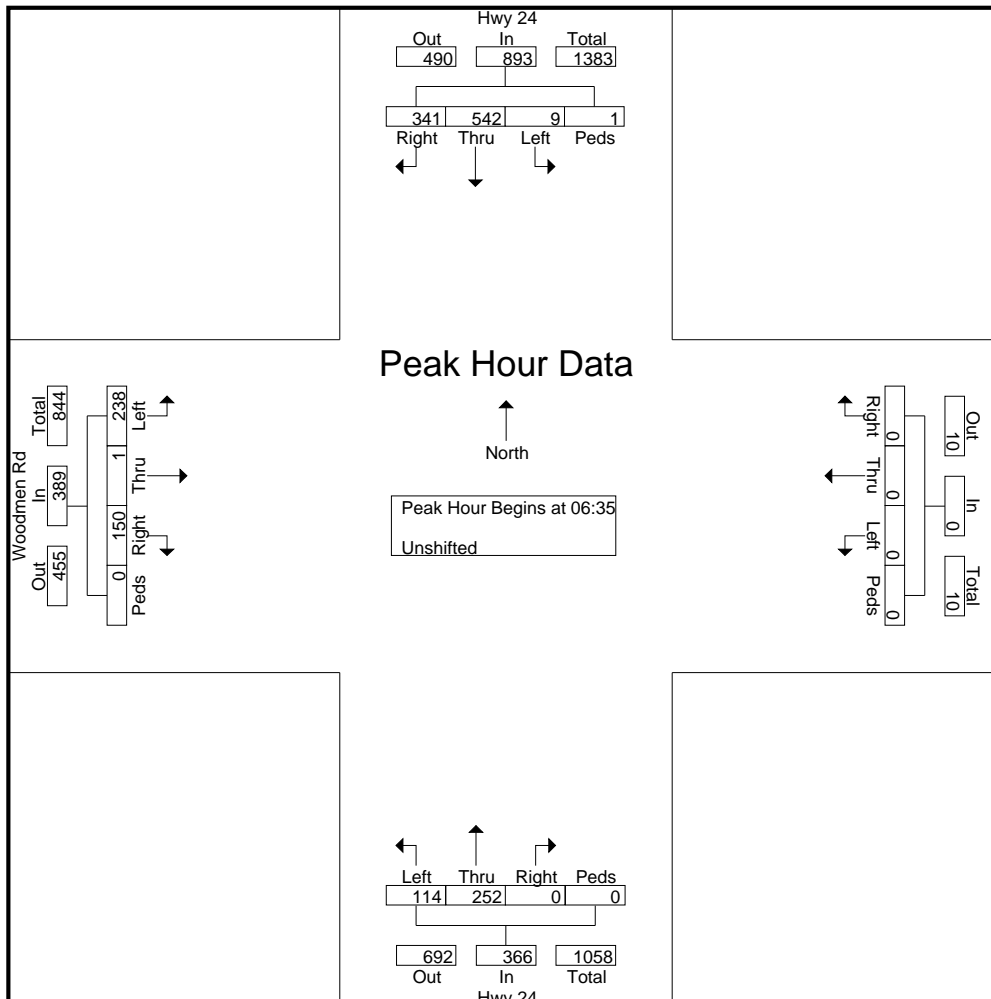

LSC Transportation Consultants, Inc.

2504 E. Pikes Peak Ave, Suite 304
 Colorado Springs, CO 80909
 719-633-2868

File Name : Hwy 24 - Woodmen Rd PM 5-23

Site Code : S214730

Start Date : 5/2/2023

Page No : 1

Groups Printed- Unshifted

Start Time	Hwy 24 Southbound					Westbound					Hwy 24 Northbound					Woodmen Rd Eastbound					Int. Total
	Right	Thru	Left	Peds	App. Total	Right	Thru	Left	Peds	App. Total	Right	Thru	Left	Peds	App. Total	Right	Thru	Left	Peds	App. Total	
16:00	26	17	0	0	43	0	0	0	0	0	0	39	33	0	72	4	0	48	0	52	167
16:05	28	28	0	0	56	0	0	0	0	0	0	41	24	0	65	9	0	41	1	51	172
16:10	28	30	0	0	58	0	0	0	0	0	0	37	21	0	58	8	0	14	0	22	138
16:15	31	28	0	0	59	0	0	0	0	0	0	40	29	0	69	9	0	53	0	62	190
16:20	24	19	0	0	43	0	0	0	0	0	0	42	23	0	65	5	0	52	0	57	165
16:25	38	26	0	0	64	0	0	0	0	0	0	41	17	0	58	9	0	43	0	52	174
16:30	20	23	0	0	43	0	0	0	0	0	0	35	21	0	56	11	0	38	0	49	148
16:35	25	19	0	2	46	0	0	0	0	0	0	40	18	0	58	12	0	44	0	56	160
16:40	32	18	0	0	50	0	0	0	0	0	0	41	28	0	69	6	0	38	0	44	163
16:45	33	26	9	0	68	0	0	0	0	0	0	59	19	0	78	9	0	5	0	14	160
16:50	32	25	0	0	57	0	0	0	0	0	0	45	22	0	67	10	0	54	1	65	189
16:55	23	14	0	0	37	0	0	0	0	0	0	35	18	0	53	6	0	50	0	56	146
Total	340	273	9	2	624	0	0	0	0	0	0	495	273	0	768	98	0	480	2	580	1972
17:00	35	23	0	0	58	0	0	0	0	0	0	44	24	0	68	10	0	44	0	54	180
17:05	26	23	0	0	49	0	0	0	0	0	0	27	26	0	53	9	0	45	0	54	156
17:10	23	34	0	0	57	0	0	0	0	0	0	50	28	0	78	4	0	43	0	47	182
17:15	26	37	0	0	63	0	0	0	0	0	0	71	37	0	108	8	0	34	0	42	213
17:20	27	28	0	4	59	0	0	0	0	0	0	42	24	0	66	6	0	46	0	52	177
17:25	37	30	0	1	68	0	0	0	0	0	0	42	26	0	68	10	0	51	0	61	197
17:30	22	13	0	0	35	0	0	0	0	0	0	37	27	0	64	10	0	39	0	49	148
17:35	29	16	0	1	46	0	0	0	0	0	0	24	23	0	47	10	0	53	0	63	156
17:40	21	19	0	1	41	0	0	0	0	0	0	35	18	0	53	7	0	61	0	68	162
17:45	16	19	0	0	35	0	0	0	0	0	0	43	34	0	77	5	0	46	0	51	163
17:50	26	16	0	0	42	0	0	0	0	0	0	44	22	0	66	8	0	25	0	33	141
17:55	23	15	0	1	39	0	0	0	0	0	0	41	26	0	67	6	0	33	0	39	145
Total	311	273	0	8	592	0	0	0	0	0	0	500	315	0	815	93	0	520	0	613	2020
Grand Total	651	546	9	10	1216	0	0	0	0	0	0	995	588	0	1583	191	0	1000	2	1193	3992
Apprch %	53.5	44.9	0.7	0.8		0	0	0	0	0	0	62.9	37.1	0		16	0	83.8	0.2		
Total %	16.3	13.7	0.2	0.3	30.5	0	0	0	0	0	0	24.9	14.7	0	39.7	4.8	0	25.1	0.1	29.9	

LSC Transportation Consultants, Inc.

2504 E. Pikes Peak Ave, Suite 304
 Colorado Springs, CO 80909
 719-633-2868

File Name : Hwy 24 - Woodmen Rd PM 5-23

Site Code : S214730

Start Date : 5/2/2023

Page No : 2

Start Time	Hwy 24 Southbound					Westbound					Hwy 24 Northbound					Woodmen Rd Eastbound					Int. Total
	Right	Thru	Left	Peds	App. Total	Right	Thru	Left	Peds	App. Total	Right	Thru	Left	Peds	App. Total	Right	Thru	Left	Peds	App. Total	
Peak Hour Analysis From 16:00 to 17:55 - Peak 1 of 1																					
Peak Hour for Entire Intersection Begins at 16:30																					
16:30	20	23	0	0	43	0	0	0	0	0	0	35	21	0	56	11	0	38	0	49	148
16:35	25	19	0	2	46	0	0	0	0	0	0	40	18	0	58	12	0	44	0	56	160
16:40	32	18	0	0	50	0	0	0	0	0	0	41	28	0	69	6	0	38	0	44	163
16:45	33	26	9	0	68	0	0	0	0	0	0	59	19	0	78	9	0	5	0	14	160
16:50	32	25	0	0	57	0	0	0	0	0	0	45	22	0	67	10	0	54	1	65	189
16:55	23	14	0	0	37	0	0	0	0	0	0	35	18	0	53	6	0	50	0	56	146
17:00	35	23	0	0	58	0	0	0	0	0	0	44	24	0	68	10	0	44	0	54	180
17:05	26	23	0	0	49	0	0	0	0	0	0	27	26	0	53	9	0	45	0	54	156
17:10	23	34	0	0	57	0	0	0	0	0	0	50	28	0	78	4	0	43	0	47	182
17:15	26	37	0	0	63	0	0	0	0	0	0	71	37	0	108	8	0	34	0	42	213
17:20	27	28	0	4	59	0	0	0	0	0	0	42	24	0	66	6	0	46	0	52	177
17:25	37	30	0	1	68	0	0	0	0	0	0	42	26	0	68	10	0	51	0	61	197
Total Volume	339	300	9	7	655	0	0	0	0	0	0	531	291	0	822	101	0	492	1	594	2071
% App. Total	51.8	45.8	1.4	1.1		0	0	0	0			64.6	35.4	0		17	0	82.8	0.2		
PHF	.764	.676	.083	.146	.803	.000	.000	.000	.000	.000	.000	.623	.655	.000	.634	.701	.000	.759	.083	.762	.810

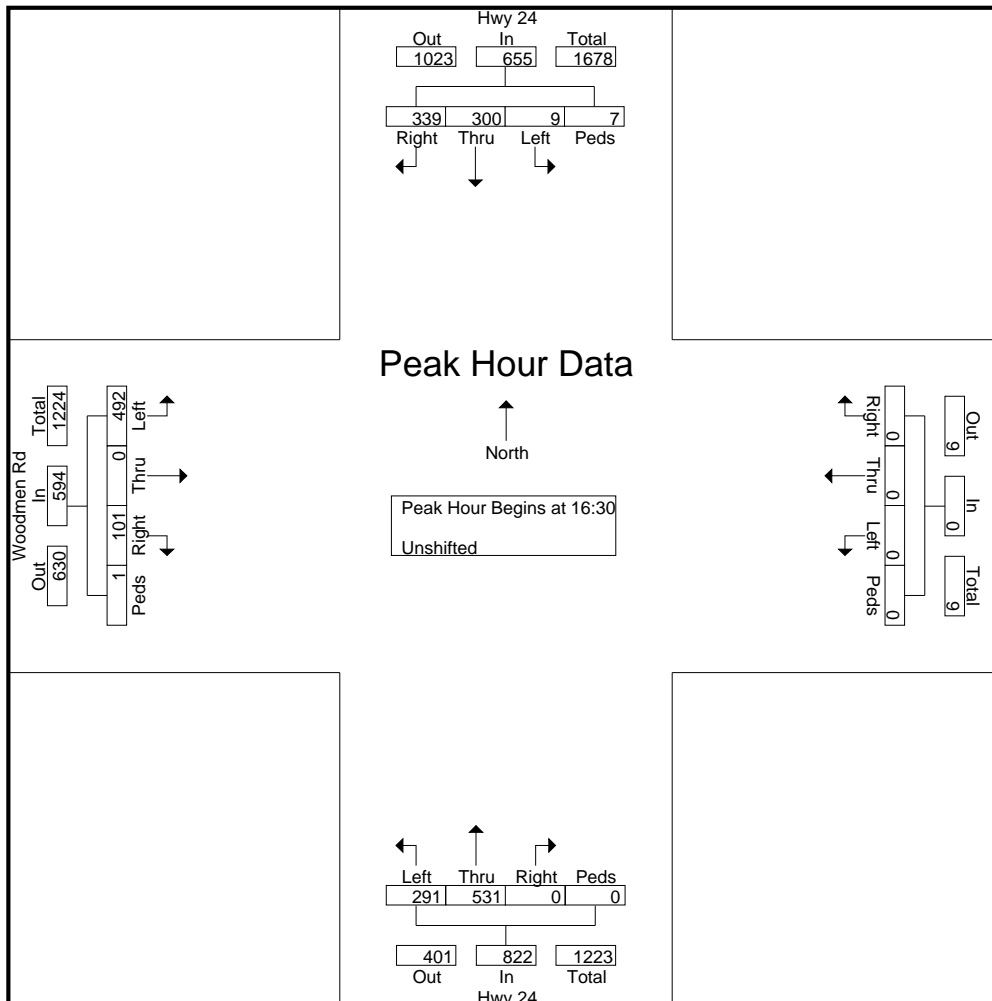

LSC Transportation Consultants, Inc.

2504 E. Pikes Peak Ave, Suite 304
 Colorado Springs, CO 80909
 719-633-2868

File Name : Hwy 24 - New Meridian Rd AM 5-23

Site Code : S214730

Start Date : 5/4/2023

Page No : 1

Groups Printed- Unshifted

Start Time	Hwy 24 Southbound					New Meridian Westbound					Hwy 24 Northbound					New Meridian Eastbound					Int. Total
	Right	Thru	Left	Peds	App. Total	Right	Thru	Left	Peds	App. Total	Right	Thru	Left	Peds	App. Total	Right	Thru	Left	Peds	App. Total	
06:30	0	59	4	0	63	1	14	0	0	15	0	20	16	0	36	49	17	0	0	66	180
06:35	1	60	5	0	66	2	13	0	0	15	0	22	15	0	37	52	15	1	0	68	186
06:40	0	58	6	0	64	0	12	0	0	12	1	19	14	0	34	50	18	0	0	68	178
06:45	1	60	7	0	68	2	16	0	0	18	0	33	15	0	48	52	14	0	0	66	200
06:50	2	52	4	0	58	1	16	0	0	17	0	22	17	0	39	54	15	1	0	70	184
06:55	1	70	1	0	72	1	10	1	0	12	0	23	13	0	36	55	22	1	0	78	198
Total	5	359	27	0	391	7	81	1	0	89	1	139	90	0	230	312	101	3	0	416	1126
07:00	0	70	1	0	71	2	5	0	0	7	2	28	21	0	51	69	26	0	0	95	224
07:05	1	49	4	0	54	0	17	0	0	17	2	21	10	0	33	74	29	2	0	105	209
07:10	1	69	3	0	73	2	6	0	0	8	0	24	19	0	43	56	20	0	0	76	200
07:15	0	64	3	0	67	1	0	0	0	1	0	21	27	0	48	69	27	0	0	96	212
07:20	0	40	4	0	44	2	24	0	0	26	0	27	15	0	42	64	27	0	0	91	203
07:25	0	39	3	0	42	5	20	2	0	27	1	25	14	0	40	65	31	2	0	98	207
07:30	0	42	1	0	43	2	24	2	0	28	2	19	11	0	32	71	38	1	0	110	213
07:35	0	44	2	0	46	0	27	4	0	31	0	34	17	0	51	43	48	0	0	91	219
07:40	0	35	5	0	40	0	19	1	0	20	0	22	16	0	38	58	41	1	1	101	199
07:45	0	38	2	0	40	2	18	2	0	22	1	18	17	0	36	55	27	0	0	82	180
07:50	0	59	0	0	59	1	2	0	0	3	2	31	16	0	49	67	19	1	0	87	198
07:55	0	70	7	0	77	2	7	0	0	9	2	31	23	0	56	37	27	0	0	64	206
Total	2	619	35	0	656	19	169	11	0	199	12	301	206	0	519	728	360	7	1	1096	2470
08:00	1	51	5	0	57	2	18	1	0	21	0	33	33	0	66	39	12	1	0	52	196
08:05	0	30	4	0	34	2	16	1	0	19	3	31	28	0	62	31	17	0	0	48	163
08:10	1	52	5	0	58	1	17	1	0	19	1	30	22	0	53	45	17	0	0	62	192
08:15	0	36	2	0	38	4	26	2	0	32	3	13	17	0	33	29	24	3	0	56	159
08:20	0	39	4	0	43	2	24	1	0	27	2	24	20	0	46	41	20	2	0	63	179
08:25	1	39	8	0	48	3	25	0	0	28	0	15	24	0	39	45	17	0	0	62	177
Grand Total	10	1225	90	0	1325	40	376	18	0	434	22	586	440	0	1048	1270	568	16	1	1855	4662
Apprch %	0.8	92.5	6.8	0		9.2	86.6	4.1	0		2.1	55.9	42	0		68.5	30.6	0.9	0.1		
Total %	0.2	26.3	1.9	0	28.4	0.9	8.1	0.4	0	9.3	0.5	12.6	9.4	0	22.5	27.2	12.2	0.3	0	39.8	

LSC Transportation Consultants, Inc.

2504 E. Pikes Peak Ave, Suite 304
 Colorado Springs, CO 80909
 719-633-2868

File Name : Hwy 24 - New Meridian Rd AM 5-23

Site Code : S214730

Start Date : 5/4/2023

Page No : 2

Start Time	Hwy 24 Southbound					New Meridian Westbound					Hwy 24 Northbound					New Meridian Eastbound					Int. Total
	Right	Thru	Left	Peds	App. Total	Right	Thru	Left	Peds	App. Total	Right	Thru	Left	Peds	App. Total	Right	Thru	Left	Peds	App. Total	
Peak Hour Analysis From 06:30 to 08:25 - Peak 1 of 1																					
Peak Hour for Entire Intersection Begins at 07:00																					
07:00	0	70	1	0	71	2	5	0	0	7	2	28	21	0	51	69	26	0	0	95	224
07:05	1	49	4	0	54	0	17	0	0	17	2	21	10	0	33	74	29	2	0	105	209
07:10	1	69	3	0	73	2	6	0	0	8	0	24	19	0	43	56	20	0	0	76	200
07:15	0	64	3	0	67	1	0	0	0	1	0	21	27	0	48	69	27	0	0	96	212
07:20	0	40	4	0	44	2	24	0	0	26	0	27	15	0	42	64	27	0	0	91	203
07:25	0	39	3	0	42	5	20	2	0	27	1	25	14	0	40	65	31	2	0	98	207
07:30	0	42	1	0	43	2	24	2	0	28	2	19	11	0	32	71	38	1	0	110	213
07:35	0	44	2	0	46	0	27	4	0	31	0	34	17	0	51	43	48	0	0	91	219
07:40	0	35	5	0	40	0	19	1	0	20	0	22	16	0	38	58	41	1	1	101	199
07:45	0	38	2	0	40	2	18	2	0	22	1	18	17	0	36	55	27	0	0	82	180
07:50	0	59	0	0	59	1	2	0	0	3	2	31	16	0	49	67	19	1	0	87	198
07:55	0	70	7	0	77	2	7	0	0	9	2	31	23	0	56	37	27	0	0	64	206
Total Volume	2	619	35	0	656	19	169	11	0	199	12	301	206	0	519	728	360	7	1	1096	2470
% App. Total	0.3	94.4	5.3	0		9.5	84.9	5.5	0		2.3	58	39.7	0		66.4	32.8	0.6	0.1		
PHF	.167	.737	.417	.000	.710	.317	.522	.229	.000	.535	.500	.738	.636	.000	.772	.820	.625	.292	.083	.830	.919

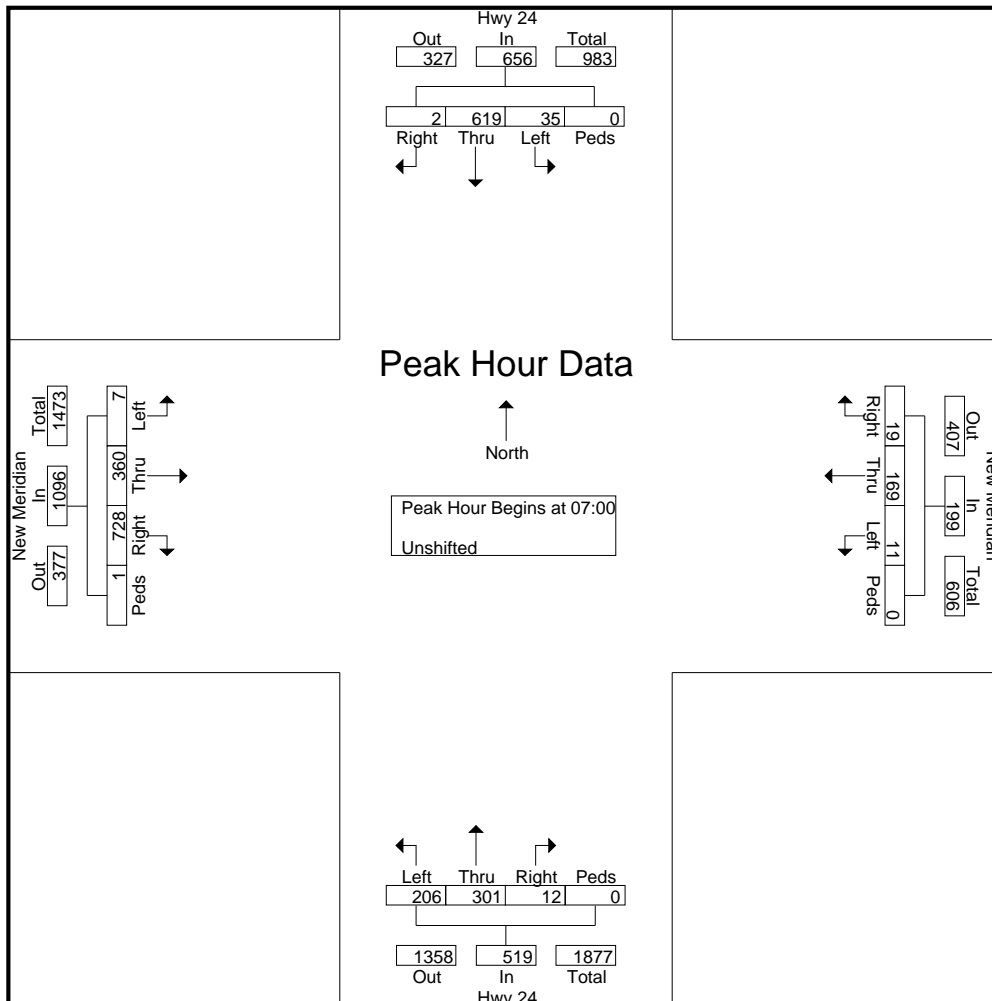

LSC Transportation Consultants, Inc.

2504 E. Pikes Peak Ave, Suite 304
 Colorado Springs, CO 80909
 719-633-2868

File Name : Hwy 24 - New Meridian PM
 Site Code : S214730
 Start Date : 5/4/2023
 Page No : 1

Groups Printed- Unshifted

Start Time	Hwy 24 Southbound					New Meridian Westbound					Hwy 24 Northbound					New Meridian Eastbound					Int. Total
	Right	Thru	Left	Peds	App. Total	Right	Thru	Left	Peds	App. Total	Right	Thru	Left	Peds	App. Total	Right	Thru	Left	Peds	App. Total	
16:00	1	37	4	0	42	1	48	2	0	51	1	47	40	0	88	23	21	2	0	46	227
16:05	0	29	8	0	37	6	28	3	0	37	0	58	41	0	99	31	21	0	0	52	225
16:10	2	35	3	0	40	4	29	0	0	33	0	55	52	0	107	18	11	4	0	33	213
16:15	0	33	5	0	38	6	34	1	0	41	1	63	53	0	117	33	20	0	0	53	249
16:20	0	44	5	0	49	4	23	1	0	28	2	65	53	0	120	30	15	1	0	46	243
16:25	1	50	4	0	55	2	28	1	0	31	0	55	50	0	105	21	17	1	0	39	230
16:30	1	21	4	0	26	4	26	0	0	30	1	51	60	0	112	16	20	2	0	38	206
16:35	0	29	5	0	34	2	37	0	0	39	0	69	54	0	123	17	19	0	1	37	233
16:40	0	29	3	0	32	3	33	1	0	37	0	42	51	0	93	24	22	2	0	48	210
16:45	0	26	5	0	31	4	22	0	0	26	0	73	63	0	136	47	15	4	0	66	259
16:50	0	22	7	0	29	6	21	1	0	28	1	53	48	0	102	25	24	3	0	52	211
16:55	2	48	2	0	52	1	22	1	0	24	0	53	43	0	96	22	22	0	0	44	216
Total	7	403	55	0	465	43	351	11	0	405	6	684	608	0	1298	307	227	19	1	554	2722
17:00	1	33	4	0	38	4	18	0	0	22	0	59	61	0	120	30	14	2	0	46	226
17:05	0	30	8	0	38	2	24	2	0	28	0	46	49	0	95	20	21	2	0	43	204
17:10	1	38	2	0	41	1	33	3	0	37	0	47	45	1	93	27	16	0	0	43	214
17:15	0	31	7	0	38	6	25	1	0	32	0	34	34	0	68	25	33	2	0	60	198
17:20	0	39	6	0	45	1	14	0	0	15	1	72	50	0	123	25	11	0	0	36	219
17:25	1	32	9	0	42	3	20	0	0	23	0	73	42	0	115	25	16	0	0	41	221
17:30	1	19	4	0	24	3	13	0	0	16	0	63	52	0	115	20	18	0	0	38	193
17:35	0	26	1	0	27	1	20	1	0	22	1	55	53	0	109	20	11	3	0	34	192
17:40	0	33	7	0	40	2	10	0	0	12	1	47	42	0	90	25	12	0	0	37	179
17:45	0	26	3	0	29	5	15	0	0	20	0	48	43	0	91	19	26	2	0	47	187
17:50	2	20	5	0	27	3	15	0	0	18	0	49	41	0	90	17	20	2	0	39	174
17:55	0	37	5	0	42	1	11	1	0	13	0	41	38	0	79	14	12	2	0	28	162
Total	6	364	61	0	431	32	218	8	0	258	3	634	550	1	1188	267	210	15	0	492	2369
Grand Total	13	767	116	0	896	75	569	19	0	663	9	1318	1158	1	2486	574	437	34	1	1046	5091
Apprch %	1.5	85.6	12.9	0		11.3	85.8	2.9	0		0.4	53	46.6	0		54.9	41.8	3.3	0.1		
Total %	0.3	15.1	2.3	0	17.6	1.5	11.2	0.4	0	13	0.2	25.9	22.7	0	48.8	11.3	8.6	0.7	0	20.5	

LSC Transportation Consultants, Inc.

2504 E. Pikes Peak Ave, Suite 304
 Colorado Springs, CO 80909
 719-633-2868

File Name : Hwy 24 - New Meridian PM

Site Code : S214730

Start Date : 5/4/2023

Page No : 2

Start Time	Hwy 24 Southbound					New Meridian Westbound					Hwy 24 Northbound					New Meridian Eastbound					Int. Total
	Right	Thru	Left	Peds	App. Total	Right	Thru	Left	Peds	App. Total	Right	Thru	Left	Peds	App. Total	Right	Thru	Left	Peds	App. Total	
Peak Hour Analysis From 16:00 to 17:55 - Peak 1 of 1																					
Peak Hour for Entire Intersection Begins at 16:00																					
16:00	1	37	4	0	42	1	48	2	0	51	1	47	40	0	88	23	21	2	0	46	227
16:05	0	29	8	0	37	6	28	3	0	37	0	58	41	0	99	31	21	0	0	52	225
16:10	2	35	3	0	40	4	29	0	0	33	0	55	52	0	107	18	11	4	0	33	213
16:15	0	33	5	0	38	6	34	1	0	41	1	63	53	0	117	33	20	0	0	53	249
16:20	0	44	5	0	49	4	23	1	0	28	2	65	53	0	120	30	15	1	0	46	243
16:25	1	50	4	0	55	2	28	1	0	31	0	55	50	0	105	21	17	1	0	39	230
16:30	1	21	4	0	26	4	26	0	0	30	1	51	60	0	112	16	20	2	0	38	206
16:35	0	29	5	0	34	2	37	0	0	39	0	69	54	0	123	17	19	0	1	37	233
16:40	0	29	3	0	32	3	33	1	0	37	0	42	51	0	93	24	22	2	0	48	210
16:45	0	26	5	0	31	4	22	0	0	26	0	73	63	0	136	47	15	4	0	66	259
16:50	0	22	7	0	29	6	21	1	0	28	1	53	48	0	102	25	24	3	0	52	211
16:55	2	48	2	0	52	1	22	1	0	24	0	53	43	0	96	22	22	0	0	44	216
Total Volume	7	403	55	0	465	43	351	11	0	405	6	684	608	0	1298	307	227	19	1	554	2722
% App. Total	1.5	86.7	11.8	0		10.6	86.7	2.7	0		0.5	52.7	46.8	0		55.4	41	3.4	0.2		
PHF	.292	.672	.573	.000	.705	.597	.609	.306	.000	.662	.250	.781	.804	.000	.795	.544	.788	.396	.083	.699	.876

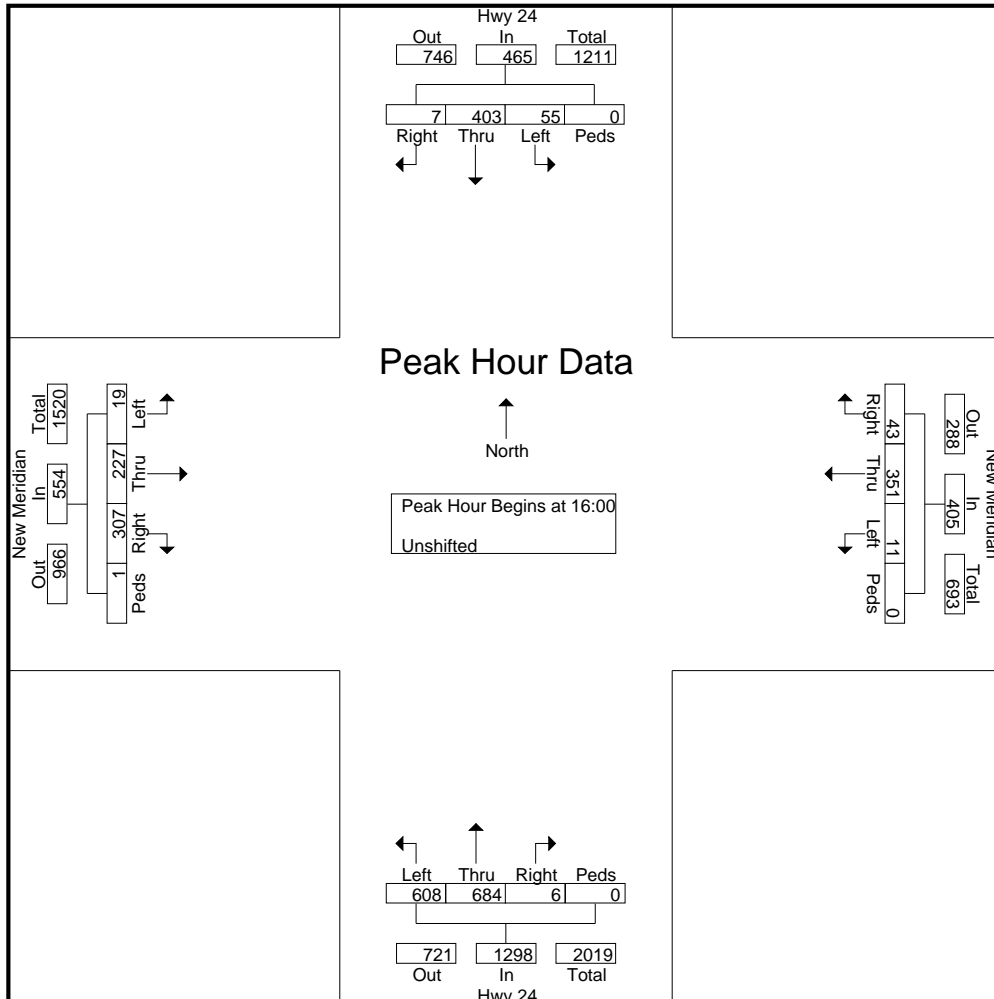

LSC Transportation Consultants, Inc.

2504 E. Pikes Peak Ave, Suite 304
 Colorado Springs, CO 80909
 719-633-2868

File Name : Hwy 24 - Rio Ln TM AM 5-23
 Site Code : S214730
 Start Date : 5/16/2023
 Page No : 1

Groups Printed- Unshifted

Start Time	Hwy 24 Southbound					Rio Ln Westbound					Hwy 24 Northbound					Eastbound					Int. Total
	R	T	L	U	App. Total	R	T	L	U	App. Total	R	T	L	U	App. Total	R	T	L	U	App. Total	
06:30	0	0	0	0	0	0	0	3	0	3	4	0	0	0	4	0	0	0	0	0	7
06:35	0	0	0	0	0	0	0	3	0	3	5	0	0	0	5	0	0	0	0	0	8
06:40	0	0	0	0	0	0	0	8	0	8	4	0	0	0	4	0	0	0	0	0	12
06:45	0	0	1	0	1	0	0	7	0	7	2	0	0	0	2	0	0	0	0	0	10
06:50	0	0	0	0	0	1	0	4	0	5	5	0	0	0	5	0	0	0	0	0	10
06:55	0	0	0	0	0	0	0	4	0	4	5	0	0	0	5	0	0	0	0	0	9
Total	0	0	1	0	1	1	0	29	0	30	25	0	0	0	25	0	0	0	0	0	56
07:00	0	0	0	0	0	0	0	7	0	7	6	0	0	0	6	0	0	0	0	0	13
07:05	0	0	0	0	0	0	0	2	0	2	5	0	0	0	5	0	0	0	0	0	7
07:10	0	0	0	0	0	0	0	3	0	3	3	0	0	0	3	0	0	0	0	0	6
07:15	0	0	0	0	0	2	0	4	0	6	10	0	0	0	10	0	0	0	0	0	16
07:20	0	0	0	0	0	0	0	2	0	2	6	0	0	0	6	0	0	0	0	0	8
07:25	0	0	1	0	1	1	0	3	0	4	6	0	0	0	6	0	0	0	0	0	11
07:30	0	0	1	0	1	1	0	1	0	2	8	0	0	0	8	0	0	0	0	0	11
07:35	0	0	1	0	1	1	0	5	0	6	11	0	0	0	11	0	0	0	0	0	18
07:40	0	0	3	0	3	0	0	4	0	4	8	0	0	0	8	0	0	0	0	0	15
07:45	0	0	0	0	0	1	0	3	0	4	3	0	0	0	3	0	0	0	0	0	7
07:50	0	0	0	0	0	4	0	5	0	9	7	0	0	0	7	0	0	0	0	0	16
07:55	0	0	0	0	0	1	0	8	0	9	3	0	0	0	3	0	0	0	0	0	12
Total	0	0	6	0	6	11	0	47	0	58	76	0	0	0	76	0	0	0	0	0	140
08:00	0	0	0	0	0	0	0	4	0	4	5	0	0	0	5	0	0	0	0	0	9

LSC Transportation Consultants, Inc.

2504 E. Pikes Peak Ave, Suite 304
 Colorado Springs, CO 80909
 719-633-2868

File Name : Hwy 24 - Rio Ln TM AM 5-23
 Site Code : S214730
 Start Date : 5/16/2023
 Page No : 2

Groups Printed- Unshifted

Start Time	Hwy 24 Southbound					Rio Ln Westbound					Hwy 24 Northbound					Eastbound					Int. Total
	R	T	L	U	App. Total	R	T	L	U	App. Total	R	T	L	U	App. Total	R	T	L	U	App. Total	
08:05	0	0	0	0	0	0	0	1	0	1	5	0	0	0	5	0	0	0	0	0	6
08:10	0	0	0	0	0	0	0	2	0	2	2	0	0	0	2	0	0	0	0	0	4
08:15	0	0	0	0	0	1	0	6	0	7	2	0	0	0	2	0	0	0	0	0	9
08:20	0	0	0	0	0	0	0	4	0	4	1	0	0	0	1	0	0	0	0	0	5
08:25	0	0	0	0	0	0	0	3	0	3	2	0	0	0	2	0	0	0	0	0	5
Grand Total	0	0	7	0	7	13	0	96	0	109	118	0	0	0	118	0	0	0	0	0	234
Apprch %	0	0	100	0		11.9	0	88.1	0		100	0	0	0		0	0	0	0		
Total %	0	0	3	0	3	5.6	0	41	0	46.6	50.4	0	0	0	50.4	0	0	0	0	0	

LSC Transportation Consultants, Inc.

2504 E. Pikes Peak Ave, Suite 304
 Colorado Springs, CO 80909
 719-633-2868

File Name : Hwy 24 - Rio Ln TM AM 5-23
 Site Code : S214730
 Start Date : 5/16/2023
 Page No : 4

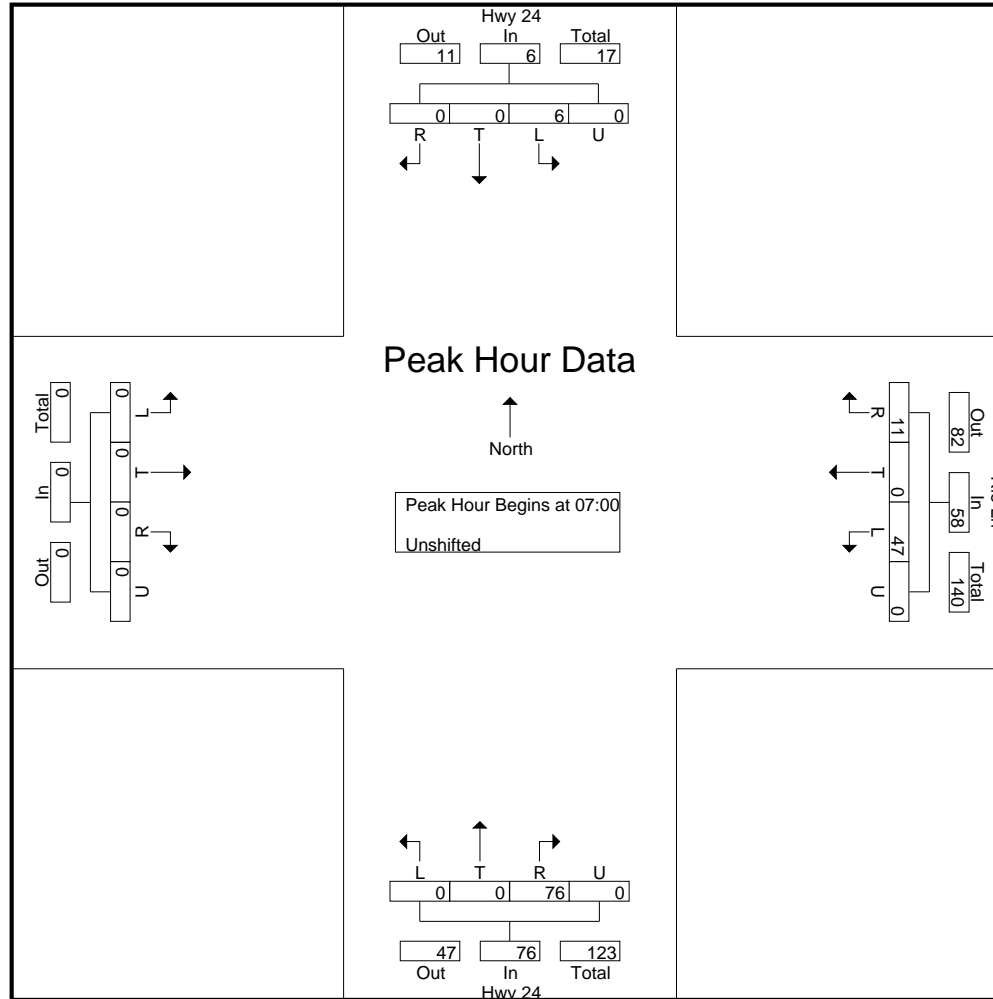

LSC Transportation Consultants, Inc.

2504 E. Pikes Peak Ave, Suite 304
 Colorado Springs, CO 80909
 719-633-2868

File Name : Hwy 24 - Rio Ln TM PM 5-23
 Site Code : S214730
 Start Date : 5/16/2023
 Page No : 1

Groups Printed- Unshifted

Start Time	Hwy 24 Southbound					Rio Ln Westbound					Hwy 24 Northbound					Eastbound					Int. Total
	R	T	L	U	App. Total	R	T	L	U	App. Total	R	T	L	U	App. Total	R	T	L	U	App. Total	
16:00	0	0	0	0	0	0	0	13	0	13	33	0	0	0	33	0	0	0	0	0	46
16:15	0	0	0	0	0	0	0	16	0	16	15	0	0	0	15	0	0	0	0	0	31
16:30	0	0	0	0	0	2	0	21	0	23	23	0	0	0	23	0	0	0	0	0	46
16:45	0	0	2	0	2	2	0	16	0	18	28	0	0	0	28	0	0	0	0	0	48
Total	0	0	2	0	2	4	0	66	0	70	99	0	0	0	99	0	0	0	0	0	171
17:00	0	0	1	0	1	0	0	5	0	5	28	0	0	0	28	0	0	0	0	0	34
17:15	0	0	1	0	1	1	0	10	0	11	19	0	0	0	19	0	0	0	0	0	31
17:30	0	0	1	0	1	2	0	5	0	7	32	0	0	0	32	0	0	0	0	0	40
17:45	0	0	0	0	0	0	0	12	0	12	21	0	0	0	21	0	0	0	0	0	33
Total	0	0	3	0	3	3	0	32	0	35	100	0	0	0	100	0	0	0	0	0	138
Grand Total	0	0	5	0	5	7	0	98	0	105	199	0	0	0	199	0	0	0	0	0	309
Apprch %	0	0	100	0		6.7	0	93.3	0		100	0	0	0		0	0	0	0		
Total %	0	0	1.6	0	1.6	2.3	0	31.7	0	34	64.4	0	0	0	64.4	0	0	0	0	0	

LSC Transportation Consultants, Inc.

2504 E. Pikes Peak Ave, Suite 304
 Colorado Springs, CO 80909
 719-633-2868

File Name : Hwy 24 - Rio Ln TM PM 5-23
 Site Code : S214730
 Start Date : 5/16/2023
 Page No : 3

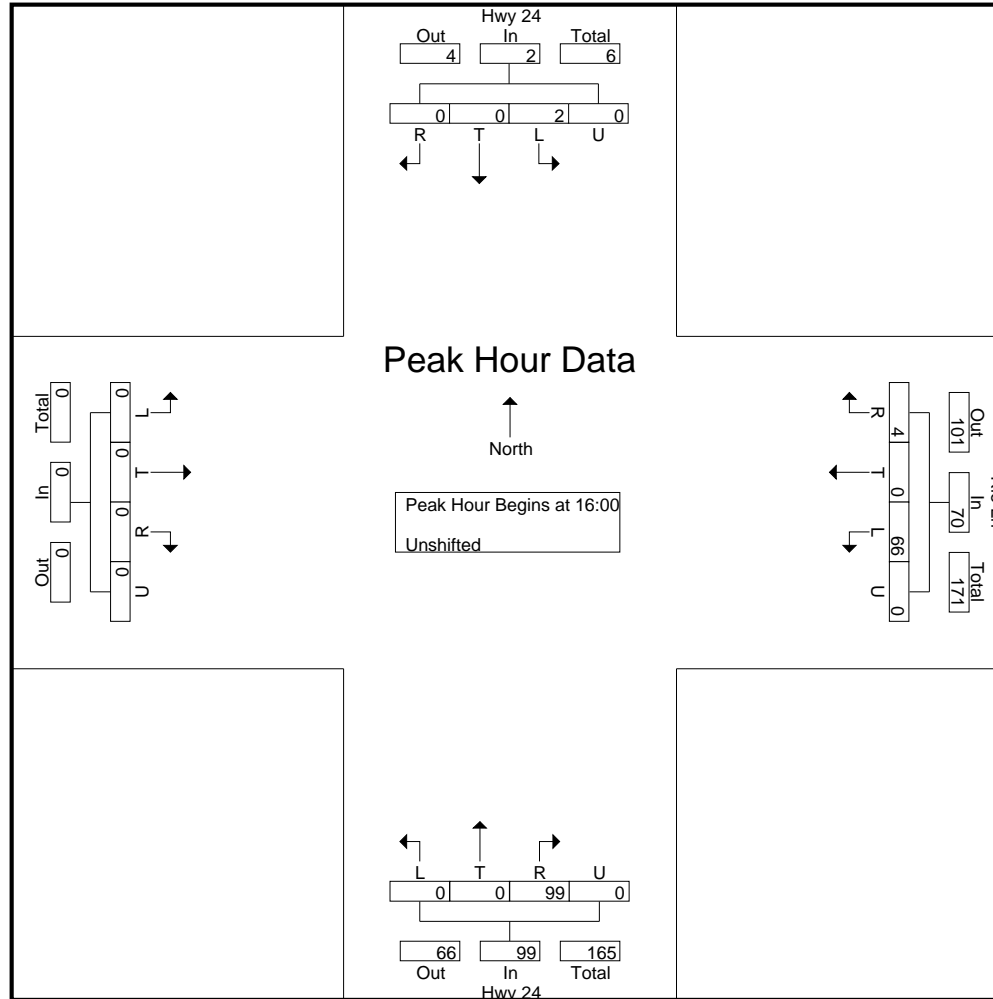

LSC Transportation Consultants, Inc.

2504 E. Pikes Peak Ave, Suite 304
 Colorado Springs, CO 80909
 719-633-2868

File Name : Hwy 24 - Old Meridian Rd AM
 Site Code : 00000000
 Start Date : 11/30/2021
 Page No : 1

Groups Printed- Unshifted

Start Time	Hwy 24 Southbound					Old Meridian Rd Westbound					Hwy 24 Northbound					Old Meridian Rd Eastbound					Int. Total
	L	T	R	U	App. Total	L	T	R	U	App. Total	L	T	R	U	App. Total	L	T	R	U	App. Total	
06:30 AM	0	187	0	0	187	0	0	4	0	4	0	76	2	0	78	0	0	7	0	7	276
06:45 AM	0	183	0	0	183	0	0	2	0	2	0	116	5	0	121	0	0	7	0	7	313
Total	0	370	0	0	370	0	0	6	0	6	0	192	7	0	199	0	0	14	0	14	589
07:00 AM	0	182	2	0	184	0	0	7	0	7	0	115	7	0	122	0	0	4	0	4	317
07:15 AM	0	125	1	0	126	0	0	7	0	7	0	92	2	0	94	0	0	6	0	6	233
07:30 AM	0	155	1	0	156	0	0	7	0	7	0	105	4	0	109	0	0	8	0	8	280
07:45 AM	0	167	3	0	170	0	0	11	0	11	0	95	4	0	99	0	0	3	0	3	283
Total	0	629	7	0	636	0	0	32	0	32	0	407	17	0	424	0	0	21	0	21	1113
08:00 AM	0	112	0	0	112	0	0	10	0	10	0	82	5	0	87	0	0	9	0	9	218
08:15 AM	0	144	4	0	148	0	0	6	0	6	0	91	5	0	96	0	1	8	0	9	259
Grand Total	0	1255	11	0	1266	0	0	54	0	54	0	772	34	0	806	0	1	52	0	53	2179
Apprch %	0	99.1	0.9	0		0	0	100	0		0	95.8	4.2	0		0	1.9	98.1	0		
Total %	0	57.6	0.5	0	58.1	0	0	2.5	0	2.5	0	35.4	1.6	0	37	0	0	2.4	0	2.4	

LSC Transportation Consultants, Inc.

2504 E. Pikes Peak Ave, Suite 304
 Colorado Springs, CO 80909
 719-633-2868

File Name : Hwy 24 - Old Meridian Rd AM
 Site Code : 00000000
 Start Date : 11/30/2021
 Page No : 2

Start Time	Hwy 24 Southbound					Old Meridian Rd Westbound					Hwy 24 Northbound					Old Meridian Rd Eastbound					Int. Total
	L	T	R	U	App. Total	L	T	R	U	App. Total	L	T	R	U	App. Total	L	T	R	U	App. Total	
Peak Hour Analysis From 6:30:00 AM to 8:15:00 AM - Peak 1 of 1																					
Peak Hour for Entire Intersection Begins at 6:45:00 AM																					
6:45:00 AM	0	183	0	0	183	0	0	2	0	2	0	116	5	0	121	0	0	7	0	7	313
7:00:00 AM	0	182	2	0	184	0	0	7	0	7	0	115	7	0	122	0	0	4	0	4	317
7:15:00 AM	0	125	1	0	126	0	0	7	0	7	0	92	2	0	94	0	0	6	0	6	233
7:30:00 AM	0	155	1	0	156	0	0	7	0	7	0	105	4	0	109	0	0	8	0	8	280
Total Volume	0	645	4	0	649	0	0	23	0	23	0	428	18	0	446	0	0	25	0	25	1143
% App. Total	0	99.4	0.6	0		0	0	100	0		0	96	4	0		0	0	100	0		
PHF	.000	.881	.500	.000	.882	.000	.000	.821	.000	.821	.000	.922	.643	.000	.914	.000	.000	.781	.000	.781	.901

LSC Transportation Consultants, Inc.

2504 E. Pikes Peak Ave, Suite 304
 Colorado Springs, CO 80909
 719-633-2868

File Name : Hwy 24 - Old Meridian Rd AM
 Site Code : 00000000
 Start Date : 11/30/2021
 Page No : 3

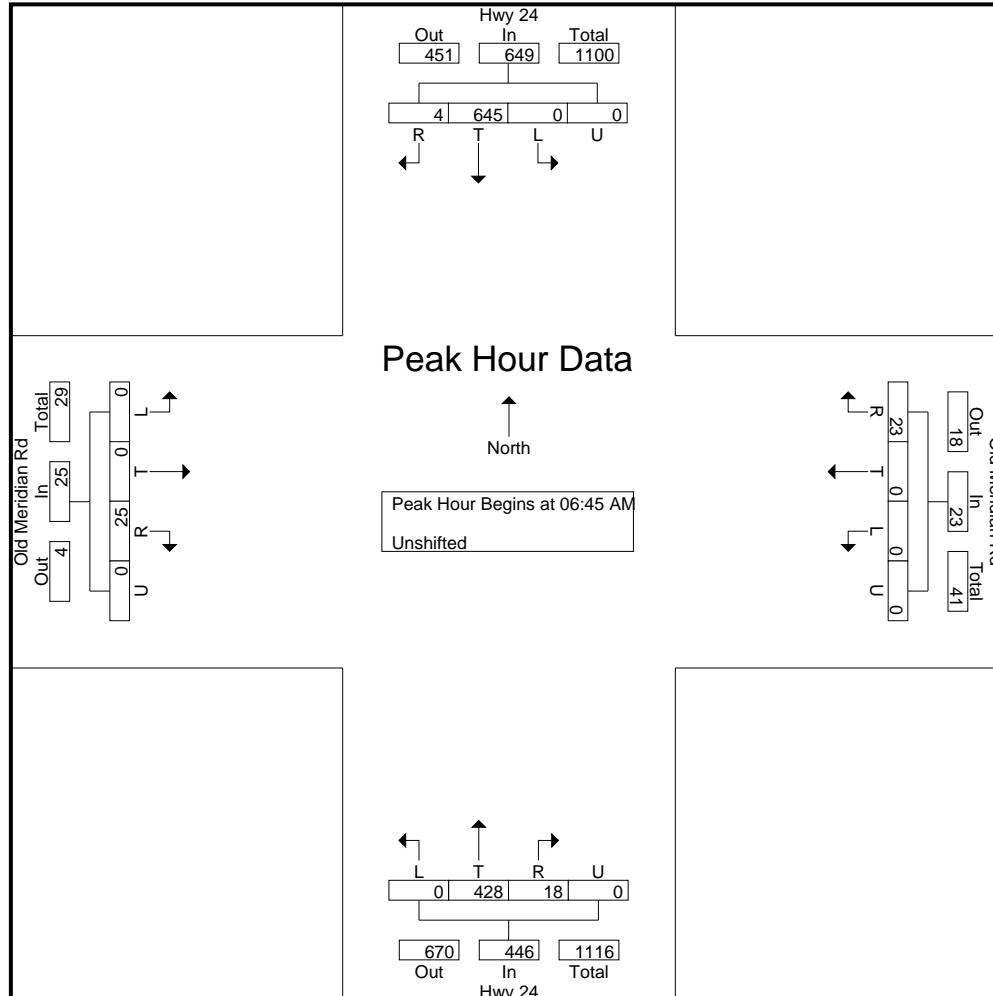

LSC Transportation Consultants, Inc.

2504 E. Pikes Peak Ave, Suite 304
 Colorado Springs, CO 80909
 719-633-2868

File Name : Hwy 24 - Old Meridian Rd PM
 Site Code : 00000000
 Start Date : 12/1/2021
 Page No : 1

Groups Printed- Unshifted

Start Time	Hwy 24 Southbound					Old Meridian Rd Westbound					Hwy 24 Northbound					Old Meridian Rd Eastbound					Int. Total
	L	T	R	U	App. Total	L	T	R	U	App. Total	L	T	R	U	App. Total	L	T	R	U	App. Total	
04:00 PM	0	118	3	0	121	0	0	12	0	12	0	152	7	0	159	0	0	19	0	19	311
04:15 PM	0	106	3	0	109	0	0	11	0	11	0	178	1	0	179	0	0	11	0	11	310
04:30 PM	0	109	3	0	112	0	0	12	0	12	0	219	1	0	220	0	0	12	0	12	356
04:45 PM	0	82	1	0	83	0	0	12	0	12	0	191	1	0	192	0	0	15	0	15	302
Total	0	415	10	0	425	0	0	47	0	47	0	740	10	0	750	0	0	57	0	57	1279
05:00 PM	0	119	1	0	120	0	0	8	0	8	0	192	6	0	198	0	0	17	0	17	343
05:15 PM	0	130	0	0	130	0	0	13	0	13	0	195	6	0	201	0	0	8	0	8	352
05:30 PM	0	89	2	0	91	0	0	12	0	12	0	179	5	0	184	0	0	16	0	16	303
05:45 PM	0	100	1	0	101	0	0	6	0	6	0	208	6	0	214	0	0	10	0	10	331
Total	0	438	4	0	442	0	0	39	0	39	0	774	23	0	797	0	0	51	0	51	1329
Grand Total	0	853	14	0	867	0	0	86	0	86	0	1514	33	0	1547	0	0	108	0	108	2608
Apprch %	0	98.4	1.6	0		0	0	100	0		0	97.9	2.1	0		0	0	100	0		
Total %	0	32.7	0.5	0	33.2	0	0	3.3	0	3.3	0	58.1	1.3	0	59.3	0	0	4.1	0	4.1	

LSC Transportation Consultants, Inc.

2504 E. Pikes Peak Ave, Suite 304
 Colorado Springs, CO 80909
 719-633-2868

File Name : Hwy 24 - Old Meridian Rd PM
 Site Code : 00000000
 Start Date : 12/1/2021
 Page No : 2

Start Time	Hwy 24 Southbound					Old Meridian Rd Westbound					Hwy 24 Northbound					Old Meridian Rd Eastbound					Int. Total
	L	T	R	U	App. Total	L	T	R	U	App. Total	L	T	R	U	App. Total	L	T	R	U	App. Total	
Peak Hour Analysis From 4:00:00 PM to 5:45:00 PM - Peak 1 of 1																					
Peak Hour for Entire Intersection Begins at 4:30:00 PM																					
4:30:00 PM	0	109	3	0	112	0	0	12	0	12	0	219	1	0	220	0	0	12	0	12	356
4:45:00 PM	0	82	1	0	83	0	0	12	0	12	0	191	1	0	192	0	0	15	0	15	302
5:00:00 PM	0	119	1	0	120	0	0	8	0	8	0	192	6	0	198	0	0	17	0	17	343
5:15:00 PM	0	130	0	0	130	0	0	13	0	13	0	195	6	0	201	0	0	8	0	8	352
Total Volume	0	440	5	0	445	0	0	45	0	45	0	797	14	0	811	0	0	52	0	52	1353
% App. Total	0	98.9	1.1	0		0	0	100	0		0	98.3	1.7	0		0	0	100	0		
PHF	.000	.846	.417	.000	.856	.000	.000	.865	.000	.865	.000	.910	.583	.000	.922	.000	.000	.765	.000	.765	.950

LSC Transportation Consultants, Inc.

2504 E. Pikes Peak Ave, Suite 304
 Colorado Springs, CO 80909
 719-633-2868

File Name : Hwy 24 - Old Meridian Rd PM
 Site Code : 00000000
 Start Date : 12/1/2021
 Page No : 3

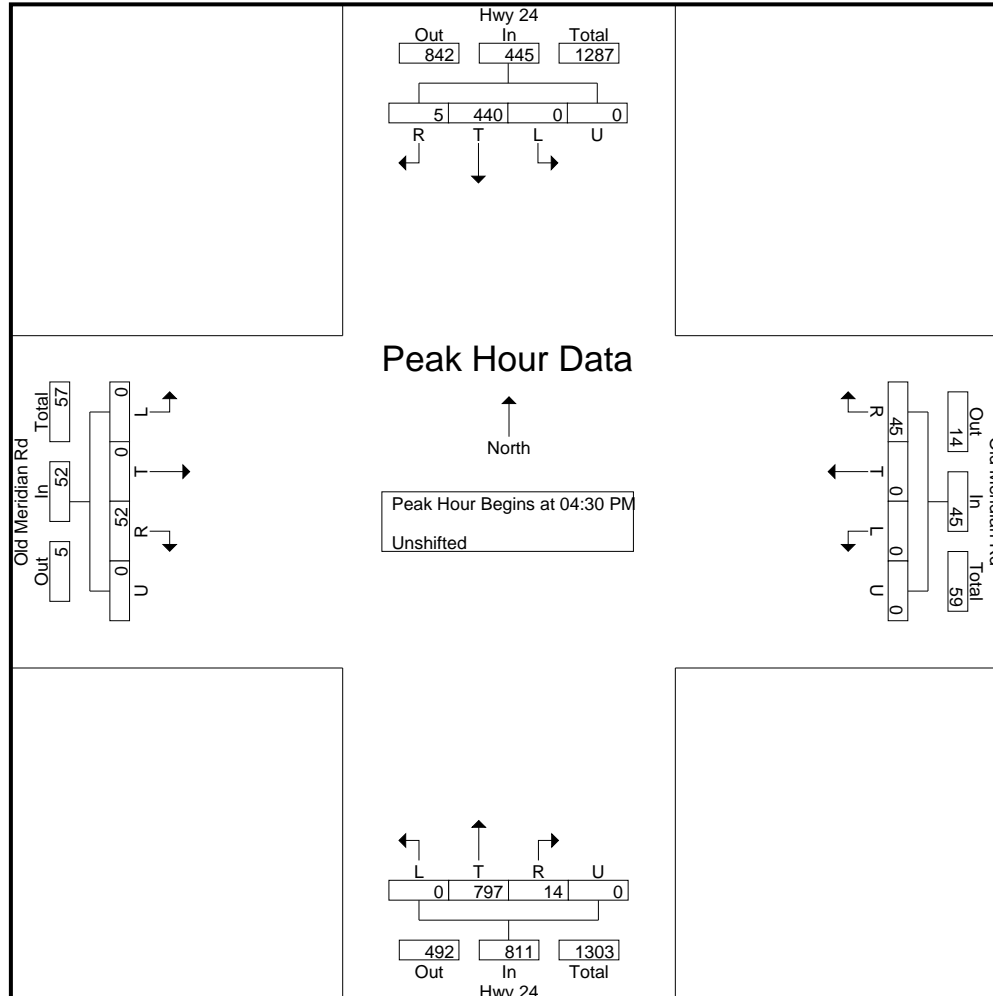

Level of Service Reports



Timings
7: Meridian Rd & Woodmen Rd

Existing Traffic
AM Peak Hour

Lane Group	EBL	EBT	EBR	WBL	WBT	WBR	NBL	NBT	NBR	SBL	SBT	SBR
Lane Configurations												
Traffic Volume (vph)	302	349	201	68	577	36	142	212	17	38	606	541
Future Volume (vph)	302	349	201	68	577	36	142	212	17	38	606	541
Turn Type	Prot	NA	Free	Prot	NA	Perm	Prot	NA	Free	Prot	NA	Free
Protected Phases	7	4		3	8		5	2		1	6	
Permitted Phases			Free			8			Free			Free
Detector Phase	7	4		3	8	8	5	2		1	6	
Switch Phase												
Minimum Initial (s)	5.0	15.0		5.0	15.0	15.0	5.0	15.0		5.0	15.0	
Minimum Split (s)	13.5	25.0		13.5	22.0	22.0	13.5	22.0		13.5	22.0	
Total Split (s)	25.0	40.0		15.0	30.0	30.0	15.0	45.0		15.0	45.0	
Total Split (%)	21.7%	34.8%		13.0%	26.1%	26.1%	13.0%	39.1%		13.0%	39.1%	
Yellow Time (s)	4.0	5.0		4.0	5.0	5.0	5.0	5.0		5.0	5.0	
All-Red Time (s)	3.5	2.0		3.5	2.0	2.0	3.5	2.0		3.5	2.0	
Lost Time Adjust (s)	0.0	0.0		0.0	0.0	0.0	0.0	0.0		0.0	0.0	
Total Lost Time (s)	7.5	7.0		7.5	7.0	7.0	8.5	7.0		8.5	7.0	
Lead/Lag	Lead	Lag		Lead	Lag	Lag	Lead	Lag		Lead	Lag	
Lead-Lag Optimize?	Yes	Yes		Yes	Yes	Yes	Yes	Yes		Yes	Yes	
Recall Mode	None	None		None	None	None	None	C-Max		None	C-Max	
Act Effct Green (s)	15.3	33.5	115.0	7.1	22.6	22.6	7.3	46.6	115.0	6.2	39.8	115.0
Actuated g/C Ratio	0.13	0.29	1.00	0.06	0.20	0.20	0.06	0.41	1.00	0.05	0.35	1.00
v/c Ratio	0.69	0.35	0.13	0.34	0.86	0.07	0.68	0.15	0.01	0.22	0.52	0.36
Control Delay	55.8	33.7	0.2	76.7	50.3	0.6	66.8	22.4	0.0	54.8	32.3	0.6
Queue Delay	0.0	0.0	0.0	0.0	0.0	0.0	0.0	0.0	0.0	0.0	0.0	0.0
Total Delay	55.8	33.7	0.2	76.7	50.3	0.6	66.8	22.4	0.0	54.8	32.3	0.6
LOS	E	C	A	E	D	A	E	C	A	D	C	A
Approach Delay		33.7			50.2			38.3			18.6	
Approach LOS		C			D			D			B	

Intersection Summary

Cycle Length: 115
 Actuated Cycle Length: 115
 Offset: 0 (0%), Referenced to phase 2:NBT and 6:SBT, Start of FDW or yellow, Master Intersection
 Natural Cycle: 75
 Control Type: Actuated-Coordinated
 Maximum v/c Ratio: 0.86
 Intersection Signal Delay: 32.1
 Intersection LOS: C
 Intersection Capacity Utilization 70.5%
 ICU Level of Service C
 Analysis Period (min) 15

Splits and Phases: 7: Meridian Rd & Woodmen Rd

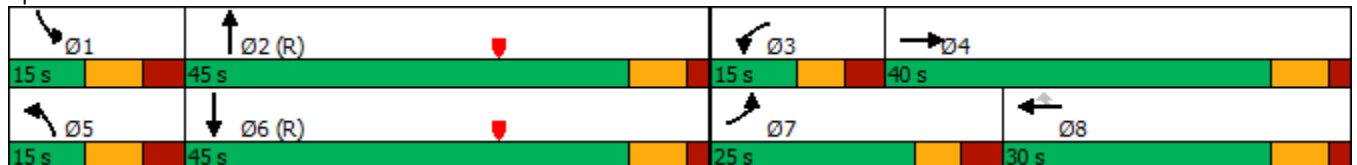

Timings
8: McLaughlin Rd & Woodmen Rd

Existing Traffic
AM Peak Hour

Lane Group	EBL	EBT	EBR	WBL	WBT	WBR	NBL	NBT	NBR	SBL	SBT	SBR
Lane Configurations												
Traffic Volume (vph)	101	257	46	28	349	143	39	45	10	121	125	293
Future Volume (vph)	101	257	46	28	349	143	39	45	10	121	125	293
Turn Type	pm+pt	NA	Perm	pm+pt	NA	Perm	pm+pt	NA	Perm	pm+pt	NA	Perm
Protected Phases	5	2		1	6		3	8		7	4	
Permitted Phases	2		2	6		6	8		8	4		4
Detector Phase	5	2	2	1	6	6	3	8	8	7	4	4
Switch Phase												
Minimum Initial (s)	5.0	5.0	5.0	5.0	5.0	5.0	5.0	5.0	5.0	5.0	5.0	5.0
Minimum Split (s)	12.5	25.0	25.0	12.5	25.0	25.0	13.5	25.0	25.0	13.5	25.0	25.0
Total Split (s)	15.0	60.0	60.0	15.0	60.0	60.0	15.0	25.0	25.0	15.0	25.0	25.0
Total Split (%)	13.0%	52.2%	52.2%	13.0%	52.2%	52.2%	13.0%	21.7%	21.7%	13.0%	21.7%	21.7%
Yellow Time (s)	4.0	5.0	5.0	4.0	5.0	5.0	5.0	5.0	5.0	5.0	5.0	5.0
All-Red Time (s)	3.5	2.0	2.0	3.5	2.0	2.0	3.5	2.0	2.0	3.5	2.0	2.0
Lost Time Adjust (s)	0.0	0.0	0.0	0.0	0.0	0.0	0.0	0.0	0.0	0.0	0.0	0.0
Total Lost Time (s)	7.5	7.0	7.0	7.5	7.0	7.0	8.5	7.0	7.0	8.5	7.0	7.0
Lead/Lag	Lead	Lag	Lag	Lead	Lag	Lag	Lead	Lag	Lag	Lead	Lag	Lag
Lead-Lag Optimize?	Yes	Yes	Yes	Yes	Yes	Yes	Yes	Yes	Yes	Yes	Yes	Yes
Recall Mode	None	C-Max	C-Max	None	C-Max	C-Max	None	Max	Max	None	Max	Max
Act Effct Green (s)	63.5	59.5	59.5	59.0	53.2	53.2	22.8	18.0	18.0	26.4	24.0	24.0
Actuated g/C Ratio	0.55	0.52	0.52	0.51	0.46	0.46	0.20	0.16	0.16	0.23	0.21	0.21
v/c Ratio	0.18	0.14	0.05	0.05	0.22	0.18	0.14	0.16	0.02	0.40	0.33	0.53
Control Delay	8.7	9.9	0.2	14.6	25.2	5.1	32.8	43.6	0.1	38.6	44.1	8.7
Queue Delay	0.0	0.0	0.0	0.0	0.0	0.0	0.0	0.0	0.0	0.0	0.0	0.0
Total Delay	8.7	9.9	0.2	14.6	25.2	5.1	32.8	43.6	0.1	38.6	44.1	8.7
LOS	A	A	A	B	C	A	C	D	A	D	D	A
Approach Delay		8.5			19.1			34.6			23.6	
Approach LOS		A			B			C			C	

Intersection Summary

Cycle Length: 115
 Actuated Cycle Length: 115
 Offset: 0 (0%), Referenced to phase 2:EBTL and 6:WBTL, Start of Green
 Natural Cycle: 80
 Control Type: Actuated-Coordinated
 Maximum v/c Ratio: 0.53
 Intersection Signal Delay: 18.9
 Intersection LOS: B
 Intersection Capacity Utilization 49.9%
 ICU Level of Service A
 Analysis Period (min) 15

Splits and Phases: 8: McLaughlin Rd & Woodmen Rd

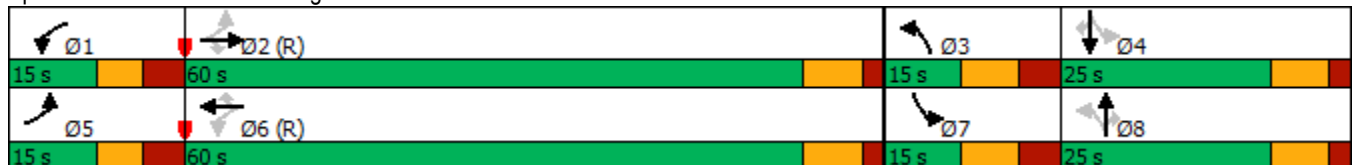

Timings
9: US 24 & Woodmen Rd

Existing Traffic
AM Peak Hour



Lane Group	EBL	EBR	NBL	NBT	SBT	SBR
Lane Configurations	↖	↗	↖↗	↑	↑	↗
Traffic Volume (vph)	238	150	130	252	542	390
Future Volume (vph)	238	150	130	252	542	390
Turn Type	Prot	Perm	pm+pt	NA	NA	Perm
Protected Phases	2		3	8	4	
Permitted Phases		2	8			4
Detector Phase	2	2	3	8	4	4
Switch Phase						
Minimum Initial (s)	5.0	5.0	5.0	5.0	5.0	5.0
Minimum Split (s)	23.5	23.5	10.5	23.5	23.5	23.5
Total Split (s)	35.0	35.0	15.0	80.0	65.0	65.0
Total Split (%)	30.4%	30.4%	13.0%	69.6%	56.5%	56.5%
Yellow Time (s)	3.0	3.0	3.0	3.0	3.0	3.0
All-Red Time (s)	2.0	2.0	2.0	2.0	2.0	2.0
Lost Time Adjust (s)	0.0	0.0	0.0	0.0	0.0	0.0
Total Lost Time (s)	5.0	5.0	5.0	5.0	5.0	5.0
Lead/Lag			Lead		Lag	Lag
Lead-Lag Optimize?			Yes		Yes	Yes
Recall Mode	C-Max	C-Max	None	None	None	None
Act Effct Green (s)	45.4	45.4	59.6	59.6	46.5	46.5
Actuated g/C Ratio	0.39	0.39	0.52	0.52	0.40	0.40
v/c Ratio	0.37	0.22	0.28	0.28	0.77	0.47
Control Delay	34.9	18.4	15.1	14.5	36.4	3.4
Queue Delay	0.0	0.0	0.0	0.0	0.0	0.0
Total Delay	34.9	18.4	15.1	14.5	36.4	3.4
LOS	C	B	B	B	D	A
Approach Delay	28.5			14.7	22.6	
Approach LOS	C			B	C	

Intersection Summary

Cycle Length: 115
 Actuated Cycle Length: 115
 Offset: 0 (0%), Referenced to phase 2:EBL and 6:, Start of Green
 Natural Cycle: 60
 Control Type: Actuated-Coordinated
 Maximum v/c Ratio: 0.77
 Intersection Signal Delay: 22.2
 Intersection LOS: C
 Intersection Capacity Utilization 58.4%
 ICU Level of Service B
 Analysis Period (min) 15

Splits and Phases: 9: US 24 & Woodmen Rd

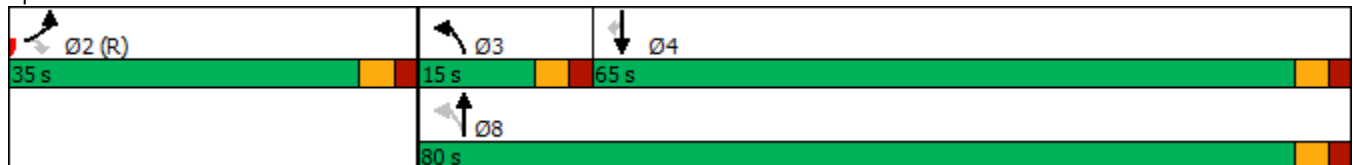

Timings
10: US 24 & Meridian Rd

Existing Traffic
AM Peak Hour

Lane Group	EBL	EBT	EBR	WBL	WBT	WBR	NBL	NBT	NBR	SBL	SBT	SBR
Lane Configurations												
Traffic Volume (vph)	7	360	728	11	169	19	206	351	12	35	676	2
Future Volume (vph)	7	360	728	11	169	19	206	351	12	35	676	2
Turn Type	pm+pt	NA	Free	pm+pt	NA	Free	pm+pt	NA	Perm	pm+pt	NA	Perm
Protected Phases	1	6		5	2		7	4		3	8	
Permitted Phases	6		Free	2		Free	4		4	8		8
Detector Phase	1	6		5	2		7	4	4	3	8	8
Switch Phase												
Minimum Initial (s)	5.0	5.0		5.0	5.0		10.0	5.0	5.0	5.0	5.0	5.0
Minimum Split (s)	11.0	20.0		11.0	20.0		16.0	20.0	20.0	11.0	20.0	20.0
Total Split (s)	11.0	22.0		11.0	22.0		18.0	71.0	71.0	11.0	64.0	64.0
Total Split (%)	9.6%	19.1%		9.6%	19.1%		15.7%	61.7%	61.7%	9.6%	55.7%	55.7%
Yellow Time (s)	3.0	5.0		3.0	5.0		3.0	4.5	4.5	3.0	4.5	4.5
All-Red Time (s)	3.0	2.0		3.0	2.0		3.0	2.0	2.0	3.0	2.0	2.0
Lost Time Adjust (s)	0.0	0.0		0.0	0.0		0.0	0.0	0.0	0.0	0.0	0.0
Total Lost Time (s)	6.0	7.0		6.0	7.0		6.0	6.5	6.5	6.0	6.5	6.5
Lead/Lag	Lead	Lag		Lead	Lag		Lead	Lag	Lag	Lead	Lag	Lag
Lead-Lag Optimize?	Yes	Yes		Yes	Yes		Yes	Yes	Yes	Yes	Yes	Yes
Recall Mode	None	C-Max		None	C-Max		None	None	None	None	None	None
Act Effct Green (s)	33.7	31.7	115.0	33.7	31.7	115.0	68.1	61.0	61.0	55.2	49.7	49.7
Actuated g/C Ratio	0.29	0.28	1.00	0.29	0.28	1.00	0.59	0.53	0.53	0.48	0.43	0.43
v/c Ratio	0.02	0.38	0.47	0.04	0.18	0.01	0.69	0.36	0.01	0.07	0.86	0.00
Control Delay	29.4	34.4	3.0	33.0	35.8	0.0	24.9	16.7	0.0	4.1	22.4	0.0
Queue Delay	0.0	0.0	0.0	0.0	0.0	0.0	0.0	0.0	0.0	0.0	0.0	0.0
Total Delay	29.4	34.4	3.0	33.0	35.8	0.0	24.9	16.7	0.0	4.1	22.4	0.0
LOS	C	C	A	C	D	A	C	B	A	A	C	A
Approach Delay		13.5			32.3			19.3			21.5	
Approach LOS		B			C			B			C	

Intersection Summary

Cycle Length: 115
 Actuated Cycle Length: 115
 Offset: 103 (90%), Referenced to phase 2:WBTL and 6:EBTL, Start of FDW or yellow
 Natural Cycle: 90
 Control Type: Actuated-Coordinated
 Maximum v/c Ratio: 0.86
 Intersection Signal Delay: 18.4
 Intersection Capacity Utilization 73.2%
 Analysis Period (min) 15
 Intersection LOS: B
 ICU Level of Service D

Splits and Phases: 10: US 24 & Meridian Rd

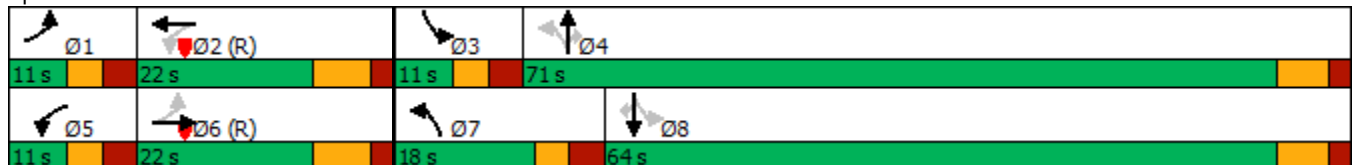

Intersection												
Int Delay, s/veh	0											
Movement	EBL	EBT	EBR	WBL	WBT	WBR	NBL	NBT	NBR	SBL	SBT	SBR
Lane Configurations			↗			↗		↖	↗		↖	↗
Traffic Vol, veh/h	0	0	25	0	0	23	0	359	18	0	688	4
Future Vol, veh/h	0	0	25	0	0	23	0	359	18	0	688	4
Conflicting Peds, #/hr	0	0	0	0	0	0	0	0	0	0	0	0
Sign Control	Stop	Stop	Stop	Stop	Stop	Stop	Free	Free	Free	Free	Free	Free
RT Channelized	-	-	Free	-	-	Free	-	-	None	-	-	None
Storage Length	-	-	0	-	-	0	-	-	400	-	-	400
Veh in Median Storage, #	-	0	-	-	0	-	-	0	-	-	0	-
Grade, %	-	0	-	-	0	-	-	0	-	-	0	-
Peak Hour Factor	91	91	91	91	91	91	91	91	91	91	91	91
Heavy Vehicles, %	2	2	2	2	2	2	2	2	2	2	2	2
Mvmt Flow	0	0	27	0	0	25	0	395	20	0	756	4

Major/Minor	Minor2		Minor1			Major1			Major2			
Conflicting Flow All	-	-	-	-	-	-	-	0	0	-	-	0
Stage 1	-	-	-	-	-	-	-	-	-	-	-	-
Stage 2	-	-	-	-	-	-	-	-	-	-	-	-
Critical Hdwy	-	-	-	-	-	-	-	-	-	-	-	-
Critical Hdwy Stg 1	-	-	-	-	-	-	-	-	-	-	-	-
Critical Hdwy Stg 2	-	-	-	-	-	-	-	-	-	-	-	-
Follow-up Hdwy	-	-	-	-	-	-	-	-	-	-	-	-
Pot Cap-1 Maneuver	0	0	0	0	0	0	0	-	-	0	-	-
Stage 1	0	0	0	0	0	0	0	-	-	0	-	-
Stage 2	0	0	0	0	0	0	0	-	-	0	-	-
Platoon blocked, %	-	-	-	-	-	-	-	-	-	-	-	-
Mov Cap-1 Maneuver	-	-	-	-	-	-	-	-	-	-	-	-
Mov Cap-2 Maneuver	-	-	-	-	-	-	-	-	-	-	-	-
Stage 1	-	-	-	-	-	-	-	-	-	-	-	-
Stage 2	-	-	-	-	-	-	-	-	-	-	-	-

Approach	EB	WB	NB	SB
HCM Control Delay, s	0	0	0	0
HCM LOS	A	A		

Minor Lane/Major Mvmt	NBT	NBR	EBLn1WBLn1	SBT	SBR
Capacity (veh/h)	-	-	-	-	-
HCM Lane V/C Ratio	-	-	-	-	-
HCM Control Delay (s)	-	-	0	0	-
HCM Lane LOS	-	-	A	A	-
HCM 95th %tile Q(veh)	-	-	-	-	-

Intersection						
Int Delay, s/veh	2					
Movement	WBL	WBR	NBT	NBR	SBL	SBT
Lane Configurations						
Traffic Vol, veh/h	47	11	414	76	6	885
Future Vol, veh/h	47	11	414	76	6	885
Conflicting Peds, #/hr	0	0	0	0	0	0
Sign Control	Stop	Stop	Free	Free	Free	Free
RT Channelized	-	None	-	None	-	None
Storage Length	0	-	-	-	-	-
Veh in Median Storage, #	0	-	0	-	-	0
Grade, %	0	-	0	-	-	0
Peak Hour Factor	88	88	88	88	88	88
Heavy Vehicles, %	2	2	2	2	2	2
Mvmt Flow	53	13	470	86	7	1006

Major/Minor	Minor1	Major1	Major2		
Conflicting Flow All	1533	513	0	0	556
Stage 1	513	-	-	-	-
Stage 2	1020	-	-	-	-
Critical Hdwy	6.42	6.22	-	-	4.12
Critical Hdwy Stg 1	5.42	-	-	-	-
Critical Hdwy Stg 2	5.42	-	-	-	-
Follow-up Hdwy	3.518	3.318	-	-	2.218
Pot Cap-1 Maneuver	128	561	-	-	1015
Stage 1	601	-	-	-	-
Stage 2	348	-	-	-	-
Platoon blocked, %			-	-	-
Mov Cap-1 Maneuver	126	561	-	-	1015
Mov Cap-2 Maneuver	126	-	-	-	-
Stage 1	601	-	-	-	-
Stage 2	342	-	-	-	-

Approach	WB	NB	SB
HCM Control Delay, s	47.5	0	0.1
HCM LOS	E		

Minor Lane/Major Mvmt	NBT	NBRWBLn1	SBL	SBT
Capacity (veh/h)	-	-	148	1015
HCM Lane V/C Ratio	-	-	0.445	0.007
HCM Control Delay (s)	-	-	47.5	8.6
HCM Lane LOS	-	-	E	A
HCM 95th %tile Q(veh)	-	-	2	0

Timings
7: Meridian Rd & Woodmen Rd

Existing Traffic
PM Peak Hour

Lane Group	EBL	EBT	EBR	WBL	WBT	WBR	NBL	NBT	NBR	SBL	SBT	SBR
Lane Configurations												
Traffic Volume (vph)	638	523	102	116	488	64	220	568	79	119	435	366
Future Volume (vph)	638	523	102	116	488	64	220	568	79	119	435	366
Turn Type	Prot	NA	Free	Prot	NA	Perm	Prot	NA	Free	Prot	NA	Free
Protected Phases	7	4		3	8		5	2		1	6	
Permitted Phases			Free			8			Free			Free
Detector Phase	7	4		3	8	8	5	2		1	6	
Switch Phase												
Minimum Initial (s)	5.0	15.0		5.0	15.0	15.0	5.0	15.0		5.0	15.0	
Minimum Split (s)	12.5	22.0		12.5	22.0	22.0	13.5	22.0		13.5	22.0	
Total Split (s)	25.0	33.0		15.0	23.0	23.0	18.0	27.0		15.0	24.0	
Total Split (%)	27.8%	36.7%		16.7%	25.6%	25.6%	20.0%	30.0%		16.7%	26.7%	
Yellow Time (s)	4.0	5.0		4.0	5.0	5.0	5.0	5.0		5.0	5.0	
All-Red Time (s)	3.5	2.0		3.5	2.0	2.0	3.5	2.0		3.5	2.0	
Lost Time Adjust (s)	0.0	0.0		0.0	0.0	0.0	0.0	0.0		0.0	0.0	
Total Lost Time (s)	7.5	7.0		7.5	7.0	7.0	8.5	7.0		8.5	7.0	
Lead/Lag	Lead	Lag		Lead	Lag	Lag	Lead	Lag		Lead	Lag	
Lead-Lag Optimize?	Yes	Yes		Yes	Yes	Yes	Yes	Yes		Yes	Yes	
Recall Mode	None	None		None	None	None	None	C-Max		None	C-Max	
Act Effct Green (s)	17.5	26.0	90.0	7.3	15.8	15.8	9.2	20.2	90.0	6.5	17.5	90.0
Actuated g/C Ratio	0.19	0.29	1.00	0.08	0.18	0.18	0.10	0.22	1.00	0.07	0.19	1.00
v/c Ratio	1.00	0.53	0.07	0.44	0.82	0.12	0.65	0.74	0.05	0.50	0.66	0.24
Control Delay	71.9	29.2	0.1	65.4	42.3	1.6	58.4	24.8	0.1	47.8	39.0	0.4
Queue Delay	0.0	0.0	0.0	0.0	0.0	0.0	0.0	0.0	0.0	0.0	0.0	0.0
Total Delay	71.9	29.2	0.1	65.4	42.3	1.6	58.4	24.8	0.1	47.8	39.0	0.4
LOS	E	C	A	E	D	A	E	C	A	D	D	A
Approach Delay		48.4			42.4			31.1			24.8	
Approach LOS		D			D			C			C	

Intersection Summary

Cycle Length: 90
 Actuated Cycle Length: 90
 Offset: 0 (0%), Referenced to phase 2:NBT and 6:SBT, Start of FDW or yellow, Master Intersection
 Natural Cycle: 80
 Control Type: Actuated-Coordinated
 Maximum v/c Ratio: 1.00
 Intersection Signal Delay: 37.4
 Intersection LOS: D
 Intersection Capacity Utilization 76.1%
 ICU Level of Service D
 Analysis Period (min) 15

Splits and Phases: 7: Meridian Rd & Woodmen Rd

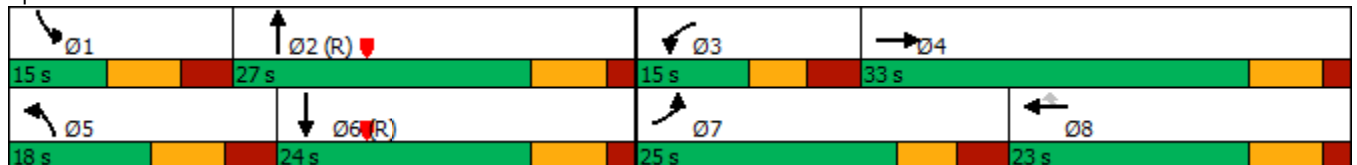

Timings
8: McLaughlin Rd & Woodmen Rd

Existing Traffic
PM Peak Hour

Lane Group	EBL	EBT	EBR	WBL	WBT	WBR	NBL	NBT	NBR	SBL	SBT	SBR
Lane Configurations												
Traffic Volume (vph)	296	328	97	45	388	266	86	165	87	185	113	194
Future Volume (vph)	296	328	97	45	388	266	86	165	87	185	113	194
Turn Type	pm+pt	NA	Perm	pm+pt	NA	Perm	pm+pt	NA	Perm	pm+pt	NA	Perm
Protected Phases	5	2		1	6		3	8		7	4	
Permitted Phases	2		2	6		6	8		8	4		4
Detector Phase	5	2	2	1	6	6	3	8	8	7	4	4
Switch Phase												
Minimum Initial (s)	5.0	5.0	5.0	5.0	5.0	5.0	5.0	5.0	5.0	5.0	5.0	5.0
Minimum Split (s)	12.5	25.0	25.0	12.5	25.0	25.0	13.5	25.0	25.0	13.5	25.0	25.0
Total Split (s)	14.0	37.0	37.0	14.0	37.0	37.0	14.0	25.0	25.0	14.0	25.0	25.0
Total Split (%)	15.6%	41.1%	41.1%	15.6%	41.1%	41.1%	15.6%	27.8%	27.8%	15.6%	27.8%	27.8%
Yellow Time (s)	4.0	5.0	5.0	4.0	5.0	5.0	5.0	5.0	5.0	5.0	5.0	5.0
All-Red Time (s)	3.5	2.0	2.0	3.5	2.0	2.0	3.5	2.0	2.0	3.5	2.0	2.0
Lost Time Adjust (s)	0.0	0.0	0.0	0.0	0.0	0.0	0.0	0.0	0.0	0.0	0.0	0.0
Total Lost Time (s)	7.5	7.0	7.0	7.5	7.0	7.0	8.5	7.0	7.0	8.5	7.0	7.0
Lead/Lag	Lead	Lag	Lag	Lead	Lag	Lag	Lead	Lag	Lag	Lead	Lag	Lag
Lead-Lag Optimize?	Yes	Yes	Yes	Yes	Yes	Yes	Yes	Yes	Yes	Yes	Yes	Yes
Recall Mode	None	C-Max	C-Max	None	C-Max	C-Max	None	Max	Max	None	Max	Max
Act Effct Green (s)	39.0	35.6	35.6	35.7	30.0	30.0	22.0	18.0	18.0	23.7	20.8	20.8
Actuated g/C Ratio	0.43	0.40	0.40	0.40	0.33	0.33	0.24	0.20	0.20	0.26	0.23	0.23
v/c Ratio	0.71	0.24	0.13	0.10	0.34	0.39	0.26	0.46	0.18	0.57	0.27	0.36
Control Delay	47.4	38.6	8.7	16.5	30.9	14.4	23.6	36.3	0.8	32.6	32.3	4.2
Queue Delay	0.0	0.0	0.0	0.0	0.0	0.0	0.0	0.0	0.0	0.0	0.0	0.0
Total Delay	47.4	38.6	8.7	16.5	30.9	14.4	23.6	36.3	0.8	32.6	32.3	4.2
LOS	D	D	A	B	C	B	C	D	A	C	C	A
Approach Delay		38.2			23.7			23.9			21.3	
Approach LOS		D			C			C			C	

Intersection Summary

Cycle Length: 90
 Actuated Cycle Length: 90
 Offset: 0 (0%), Referenced to phase 2:EBTL and 6:WBTL, Start of Green
 Natural Cycle: 80
 Control Type: Actuated-Coordinated
 Maximum v/c Ratio: 0.71
 Intersection Signal Delay: 27.8
 Intersection LOS: C
 Intersection Capacity Utilization 69.4%
 ICU Level of Service C
 Analysis Period (min) 15

Splits and Phases: 8: McLaughlin Rd & Woodmen Rd

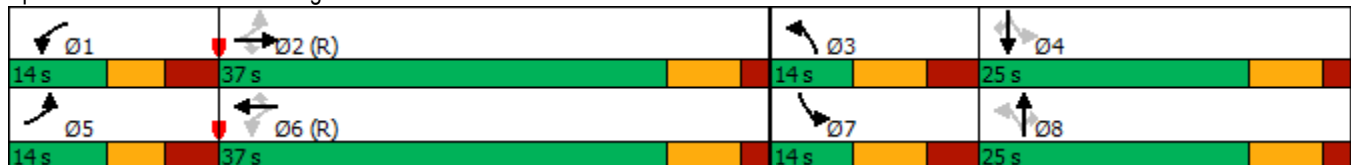

Timings
9: US 24 & Woodmen Rd

Existing Traffic
PM Peak Hour



Lane Group	EBL	EBR	NBL	NBT	SBT	SBR
Lane Configurations	↶	↷	↶↷	↶	↶	↷
Traffic Volume (vph)	498	102	323	531	316	376
Future Volume (vph)	498	102	323	531	316	376
Turn Type	Prot	Perm	pm+pt	NA	NA	Perm
Protected Phases	2		3	8	4	
Permitted Phases		2	8			4
Detector Phase	2	2	3	8	4	4
Switch Phase						
Minimum Initial (s)	5.0	5.0	5.0	5.0	5.0	5.0
Minimum Split (s)	23.5	23.5	10.5	23.5	23.5	23.5
Total Split (s)	30.0	30.0	20.0	60.0	40.0	40.0
Total Split (%)	33.3%	33.3%	22.2%	66.7%	44.4%	44.4%
Yellow Time (s)	3.0	3.0	3.0	3.0	3.0	3.0
All-Red Time (s)	2.0	2.0	2.0	2.0	2.0	2.0
Lost Time Adjust (s)	0.0	0.0	0.0	0.0	0.0	0.0
Total Lost Time (s)	5.0	5.0	5.0	5.0	5.0	5.0
Lead/Lag			Lead		Lag	Lag
Lead-Lag Optimize?			Yes		Yes	Yes
Recall Mode	C-Max	C-Max	None	None	None	None
Act Effct Green (s)	37.9	37.9	42.1	42.1	25.5	25.5
Actuated g/C Ratio	0.42	0.42	0.47	0.47	0.28	0.28
v/c Ratio	0.70	0.15	0.51	0.72	0.70	0.57
Control Delay	33.1	7.2	26.8	37.5	35.2	5.4
Queue Delay	0.0	0.0	0.0	0.0	0.0	0.0
Total Delay	33.1	7.2	26.8	37.5	35.2	5.4
LOS	C	A	C	D	D	A
Approach Delay	28.7			33.4	19.0	
Approach LOS	C			C	B	

Intersection Summary

Cycle Length: 90
 Actuated Cycle Length: 90
 Offset: 0 (0%), Referenced to phase 2:EBL and 6:, Start of Green
 Natural Cycle: 60
 Control Type: Actuated-Coordinated
 Maximum v/c Ratio: 0.72
 Intersection Signal Delay: 27.4
 Intersection LOS: C
 Intersection Capacity Utilization 65.9%
 ICU Level of Service C
 Analysis Period (min) 15

Splits and Phases: 9: US 24 & Woodmen Rd



Timings
10: US 24 & Meridian Rd

Existing Traffic
PM Peak Hour

Lane Group	EBL	EBT	EBR	WBL	WBT	WBR	NBL	NBT	NBR	SBL	SBT	SBR
Lane Configurations												
Traffic Volume (vph)	19	227	307	11	351	43	608	761	6	55	403	7
Future Volume (vph)	19	227	307	11	351	43	608	761	6	55	403	7
Turn Type	pm+pt	NA	Perm	pm+pt	NA	Perm	pm+pt	NA	Perm	pm+pt	NA	Perm
Protected Phases	5	2		1	6		3	8		7	4	
Permitted Phases	2		2	6		6	8		8	4		4
Detector Phase	5	2	2	1	6	6	3	8	8	7	4	4
Switch Phase												
Minimum Initial (s)	5.0	5.0	5.0	5.0	5.0	5.0	5.0	5.0	5.0	5.0	5.0	5.0
Minimum Split (s)	11.0	20.0	20.0	11.0	20.0	20.0	11.0	20.0	20.0	11.0	20.0	20.0
Total Split (s)	11.0	20.0	20.0	11.0	20.0	20.0	31.0	47.0	47.0	12.0	28.0	28.0
Total Split (%)	12.2%	22.2%	22.2%	12.2%	22.2%	22.2%	34.4%	52.2%	52.2%	13.3%	31.1%	31.1%
Yellow Time (s)	3.0	5.0	5.0	3.0	5.0	5.0	3.0	4.5	4.5	3.0	4.5	4.5
All-Red Time (s)	3.0	2.0	2.0	3.0	2.0	2.0	3.0	2.0	2.0	3.0	2.0	2.0
Lost Time Adjust (s)	0.0	0.0	0.0	0.0	0.0	0.0	0.0	0.0	0.0	0.0	0.0	0.0
Total Lost Time (s)	6.0	7.0	7.0	6.0	7.0	7.0	6.0	6.5	6.5	6.0	6.5	6.5
Lead/Lag	Lead	Lag	Lag	Lead	Lag	Lag	Lead	Lag	Lag	Lead	Lag	Lag
Lead-Lag Optimize?	Yes	Yes	Yes	Yes	Yes	Yes	Yes	Yes	Yes	Yes	Yes	Yes
Recall Mode	None	C-Max	C-Max	None	C-Max	C-Max	None	None	None	None	None	None
Act Effct Green (s)	23.8	21.8	21.8	22.6	19.6	19.6	53.0	42.9	42.9	27.9	21.5	21.5
Actuated g/C Ratio	0.26	0.24	0.24	0.25	0.22	0.22	0.59	0.48	0.48	0.31	0.24	0.24
v/c Ratio	0.08	0.28	0.52	0.04	0.48	0.08	1.13	0.91	0.01	0.30	0.96	0.01
Control Delay	26.3	29.7	9.2	24.3	34.9	0.3	102.0	39.8	0.0	21.5	73.9	0.0
Queue Delay	0.0	0.0	0.0	0.0	0.0	0.0	0.0	0.0	0.0	0.0	0.0	0.0
Total Delay	26.3	29.7	9.2	24.3	34.9	0.3	102.0	39.8	0.0	21.5	73.9	0.0
LOS	C	C	A	C	C	A	F	D	A	C	E	A
Approach Delay		18.2			30.9			67.1			66.6	
Approach LOS		B			C			E			E	

Intersection Summary

Cycle Length: 90
 Actuated Cycle Length: 90
 Offset: 71 (79%), Referenced to phase 2:EBTL and 6:WBTL, Start of FDW or yellow
 Natural Cycle: 90
 Control Type: Actuated-Coordinated
 Maximum v/c Ratio: 1.13
 Intersection Signal Delay: 52.1
 Intersection LOS: D
 Intersection Capacity Utilization 86.9%
 ICU Level of Service E
 Analysis Period (min) 15

Splits and Phases: 10: US 24 & Meridian Rd

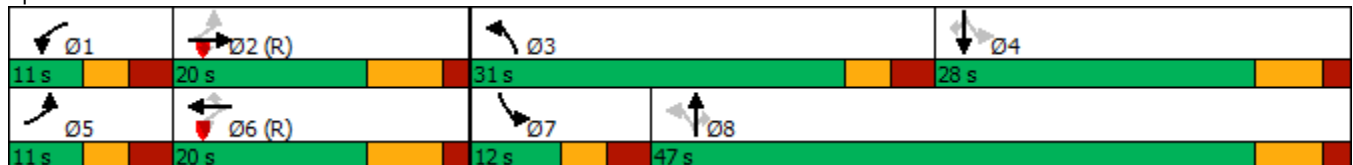

Intersection												
Int Delay, s/veh	0											
Movement	EBL	EBT	EBR	WBL	WBT	WBR	NBL	NBT	NBR	SBL	SBT	SBR
Lane Configurations			↗			↗		↖	↗		↖	↗
Traffic Vol, veh/h	0	0	52	0	0	45	0	809	14	0	413	5
Future Vol, veh/h	0	0	52	0	0	45	0	809	14	0	413	5
Conflicting Peds, #/hr	0	0	0	0	0	0	0	0	0	0	0	0
Sign Control	Stop	Stop	Stop	Stop	Stop	Stop	Free	Free	Free	Free	Free	Free
RT Channelized	-	-	Free	-	-	Free	-	-	None	-	-	None
Storage Length	-	-	0	-	-	0	-	-	400	-	-	400
Veh in Median Storage, #	-	0	-	-	0	-	-	0	-	-	0	-
Grade, %	-	0	-	-	0	-	-	0	-	-	0	-
Peak Hour Factor	90	90	90	90	90	90	90	90	90	90	90	90
Heavy Vehicles, %	2	2	2	2	2	2	2	2	2	2	2	2
Mvmt Flow	0	0	58	0	0	50	0	899	16	0	459	6

Major/Minor	Minor2		Minor1			Major1			Major2			
Conflicting Flow All	-	-	-	-	-	-	-	0	0	-	-	0
Stage 1	-	-	-	-	-	-	-	-	-	-	-	-
Stage 2	-	-	-	-	-	-	-	-	-	-	-	-
Critical Hdwy	-	-	-	-	-	-	-	-	-	-	-	-
Critical Hdwy Stg 1	-	-	-	-	-	-	-	-	-	-	-	-
Critical Hdwy Stg 2	-	-	-	-	-	-	-	-	-	-	-	-
Follow-up Hdwy	-	-	-	-	-	-	-	-	-	-	-	-
Pot Cap-1 Maneuver	0	0	0	0	0	0	0	-	-	0	-	-
Stage 1	0	0	0	0	0	0	0	-	-	0	-	-
Stage 2	0	0	0	0	0	0	0	-	-	0	-	-
Platoon blocked, %	-	-	-	-	-	-	-	-	-	-	-	-
Mov Cap-1 Maneuver	-	-	-	-	-	-	-	-	-	-	-	-
Mov Cap-2 Maneuver	-	-	-	-	-	-	-	-	-	-	-	-
Stage 1	-	-	-	-	-	-	-	-	-	-	-	-
Stage 2	-	-	-	-	-	-	-	-	-	-	-	-

Approach	EB		WB			NB			SB		
HCM Control Delay, s	0		0			0			0		
HCM LOS	A		A								

Minor Lane/Major Mvmt	NBT	NBR	EBLn1WBLn1	SBT	SBR
Capacity (veh/h)	-	-	-	-	-
HCM Lane V/C Ratio	-	-	-	-	-
HCM Control Delay (s)	-	-	0	0	-
HCM Lane LOS	-	-	A	A	-
HCM 95th %tile Q(veh)	-	-	-	-	-

Intersection						
Int Delay, s/veh	388.2					
Movement	WBL	WBR	NBT	NBR	SBL	SBT
Lane Configurations						
Traffic Vol, veh/h	66	4	930	99	2	626
Future Vol, veh/h	66	4	930	99	2	626
Conflicting Peds, #/hr	0	0	0	0	0	0
Sign Control	Free	Free	Free	Free	Stop	Stop
RT Channelized	-	None	-	None	-	None
Storage Length	0	-	-	-	-	-
Veh in Median Storage, #	0	-	0	-	-	0
Grade, %	0	-	0	-	-	0
Peak Hour Factor	87	87	87	87	87	87
Heavy Vehicles, %	2	2	2	2	2	2
Mvmt Flow	76	5	1069	114	2	720

Major/Minor	Major1	Minor2
Conflicting Flow All	0	0 1126 1183
Stage 1	-	- 0 0
Stage 2	-	- 1126 1183
Critical Hdwy	-	- 6.42 6.52
Critical Hdwy Stg 1	-	- - -
Critical Hdwy Stg 2	-	- 5.42 5.52
Follow-up Hdwy	-	- 3.518 4.018
Pot Cap-1 Maneuver	-	- 227 ~ 189
Stage 1	-	- - -
Stage 2	-	- 310 ~ 263
Platoon blocked, %	-	- -
Mov Cap-1 Maneuver	-	- 227 0
Mov Cap-2 Maneuver	-	- 227 0
Stage 1	-	- - 0
Stage 2	-	- 310 0

Approach	NB	SB
HCM Control Delay, s	0	\$ 1024.4
HCM LOS		F

Minor Lane/Major Mvmt	NBT	NBR	SBLn1
Capacity (veh/h)	-	-	227
HCM Lane V/C Ratio	-	-	3.18
HCM Control Delay (s)	-	-	\$ 1024.4
HCM Lane LOS	-	-	F
HCM 95th %tile Q(veh)	-	-	66

Notes
 ~: Volume exceeds capacity \$: Delay exceeds 300s +: Computation Not Defined *: All major volume in platoon

Timings
7: Meridian Rd & Woodmen Rd

2028 Background Traffic
AM Peak Hour

Lane Group	EBL	EBT	EBR	WBL	WBT	WBR	NBL	NBT	NBR	SBL	SBT	SBR
Lane Configurations												
Traffic Volume (vph)	302	367	233	68	600	36	165	212	17	38	606	541
Future Volume (vph)	302	367	233	68	600	36	165	212	17	38	606	541
Turn Type	Prot	NA	Free	Prot	NA	Perm	Prot	NA	Free	Prot	NA	Free
Protected Phases	7	4		3	8		5	2		1	6	
Permitted Phases			Free			8			Free			Free
Detector Phase	7	4		3	8	8	5	2		1	6	
Switch Phase												
Minimum Initial (s)	5.0	15.0		5.0	15.0	15.0	5.0	15.0		5.0	15.0	
Minimum Split (s)	12.5	22.0		12.5	22.0	22.0	13.5	22.0		13.5	22.0	
Total Split (s)	25.0	33.0		15.0	23.0	23.0	18.0	27.0		15.0	24.0	
Total Split (%)	27.8%	36.7%		16.7%	25.6%	25.6%	20.0%	30.0%		16.7%	26.7%	
Yellow Time (s)	4.0	5.0		4.0	5.0	5.0	5.0	5.0		5.0	5.0	
All-Red Time (s)	3.5	2.0		3.5	2.0	2.0	3.5	2.0		3.5	2.0	
Lost Time Adjust (s)	0.0	0.0		0.0	0.0	0.0	0.0	0.0		0.0	0.0	
Total Lost Time (s)	7.5	7.0		7.5	7.0	7.0	8.5	7.0		8.5	7.0	
Lead/Lag	Lead	Lag		Lead	Lag	Lag	Lead	Lag		Lead	Lag	
Lead-Lag Optimize?	Yes	Yes		Yes	Yes	Yes	Yes	Yes		Yes	Yes	
Recall Mode	None	None		None	None	None	None	C-Max		None	C-Max	
Act Effct Green (s)	13.5	28.6	90.0	6.9	19.4	19.4	8.9	26.6	90.0	6.2	18.3	90.0
Actuated g/C Ratio	0.15	0.32	1.00	0.08	0.22	0.22	0.10	0.30	1.00	0.07	0.20	1.00
v/c Ratio	0.61	0.34	0.15	0.27	0.82	0.06	0.51	0.21	0.01	0.17	0.88	0.36
Control Delay	40.8	25.5	0.2	59.7	38.2	0.2	47.7	14.7	0.0	41.1	50.9	0.6
Queue Delay	0.0	0.0	0.0	0.0	0.0	0.0	0.0	0.0	0.0	0.0	0.0	0.0
Total Delay	40.8	25.5	0.2	59.7	38.2	0.2	47.7	14.7	0.0	41.1	50.9	0.6
LOS	D	C	A	E	D	A	D	B	A	D	D	A
Approach Delay		24.1			38.3			27.9			27.6	
Approach LOS		C			D			C			C	

Intersection Summary

Cycle Length: 90
 Actuated Cycle Length: 90
 Offset: 0 (0%), Referenced to phase 2:NBT and 6:SBT, Start of FDW or yellow, Master Intersection
 Natural Cycle: 75
 Control Type: Actuated-Coordinated
 Maximum v/c Ratio: 0.88
 Intersection Signal Delay: 29.0
 Intersection LOS: C
 Intersection Capacity Utilization 71.7%
 ICU Level of Service C
 Analysis Period (min) 15

Splits and Phases: 7: Meridian Rd & Woodmen Rd

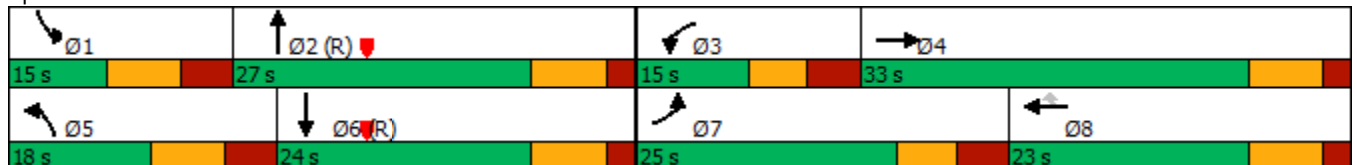

Timings
8: McLaughlin Rd & Woodmen Rd

2028 Background Traffic
AM Peak Hour

Lane Group	EBL	EBT	EBR	WBL	WBT	WBR	NBL	NBT	NBR	SBL	SBT	SBR
Lane Configurations												
Traffic Volume (vph)	101	275	46	28	372	143	39	45	10	121	125	293
Future Volume (vph)	101	275	46	28	372	143	39	45	10	121	125	293
Turn Type	pm+pt	NA	Perm	pm+pt	NA	Perm	pm+pt	NA	Perm	pm+pt	NA	Perm
Protected Phases	5	2		1	6		3	8		7	4	
Permitted Phases	2		2	6		6	8		8	4		4
Detector Phase	5	2	2	1	6	6	3	8	8	7	4	4
Switch Phase												
Minimum Initial (s)	5.0	5.0	5.0	5.0	5.0	5.0	5.0	5.0	5.0	5.0	5.0	5.0
Minimum Split (s)	12.5	25.0	25.0	12.5	25.0	25.0	13.5	25.0	25.0	13.5	25.0	25.0
Total Split (s)	14.0	37.0	37.0	14.0	37.0	37.0	14.0	25.0	25.0	14.0	25.0	25.0
Total Split (%)	15.6%	41.1%	41.1%	15.6%	41.1%	41.1%	15.6%	27.8%	27.8%	15.6%	27.8%	27.8%
Yellow Time (s)	4.0	5.0	5.0	4.0	5.0	5.0	5.0	5.0	5.0	5.0	5.0	5.0
All-Red Time (s)	3.5	2.0	2.0	3.5	2.0	2.0	3.5	2.0	2.0	3.5	2.0	2.0
Lost Time Adjust (s)	0.0	0.0	0.0	0.0	0.0	0.0	0.0	0.0	0.0	0.0	0.0	0.0
Total Lost Time (s)	7.5	7.0	7.0	7.5	7.0	7.0	8.5	7.0	7.0	8.5	7.0	7.0
Lead/Lag	Lead	Lag	Lag	Lead	Lag	Lag	Lead	Lag	Lag	Lead	Lag	Lag
Lead-Lag Optimize?	Yes	Yes	Yes	Yes	Yes	Yes	Yes	Yes	Yes	Yes	Yes	Yes
Recall Mode	None	C-Max	C-Max	None	C-Max	C-Max	None	Max	Max	None	Max	Max
Act Effct Green (s)	40.5	38.4	38.4	37.3	32.8	32.8	22.0	18.0	18.0	25.4	23.6	23.6
Actuated g/C Ratio	0.45	0.43	0.43	0.41	0.36	0.36	0.24	0.20	0.20	0.28	0.26	0.26
v/c Ratio	0.23	0.19	0.06	0.06	0.29	0.20	0.12	0.12	0.02	0.32	0.26	0.47
Control Delay	34.1	38.8	4.8	12.9	22.2	0.7	21.6	30.7	0.1	25.1	30.7	6.7
Queue Delay	0.0	0.0	0.0	0.0	0.0	0.0	0.0	0.0	0.0	0.0	0.0	0.0
Total Delay	34.1	38.8	4.8	12.9	22.2	0.7	21.6	30.7	0.1	25.1	30.7	6.7
LOS	C	D	A	B	C	A	C	C	A	C	C	A
Approach Delay		34.0			16.0			23.7			16.4	
Approach LOS		C			B			C			B	

Intersection Summary

Cycle Length: 90
 Actuated Cycle Length: 90
 Offset: 0 (0%), Referenced to phase 2:EBTL and 6:WBTL, Start of Green
 Natural Cycle: 80
 Control Type: Actuated-Coordinated
 Maximum v/c Ratio: 0.47
 Intersection Signal Delay: 21.4
 Intersection LOS: C
 Intersection Capacity Utilization 50.5%
 ICU Level of Service A
 Analysis Period (min) 15

Splits and Phases: 8: McLaughlin Rd & Woodmen Rd

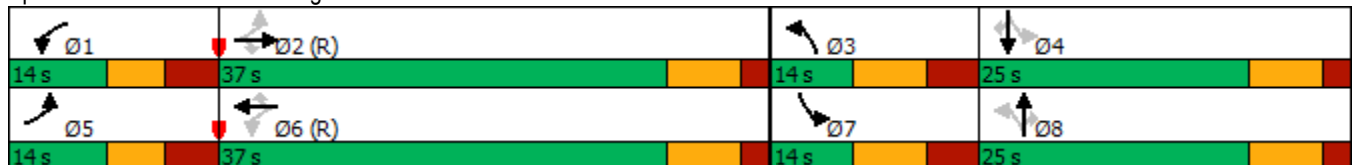

Timings
9: US 24 & Woodmen Rd

2028 Background Traffic
AM Peak Hour

Lane Group	EBL	EBT	EBR	WBL	WBT	WBR	NBL	NBT	NBR	SBL	SBT	SBR
Lane Configurations												
Traffic Volume (vph)	203	35	168	5	25	11	153	221	5	6	536	365
Future Volume (vph)	203	35	168	5	25	11	153	221	5	6	536	365
Turn Type	pm+pt	NA	Free	pm+pt	NA	Free	pm+pt	NA	Free	pm+pt	NA	Free
Protected Phases	7	4		3	8		5	2		1	6	
Permitted Phases	4		Free	8		Free	2		Free	6		Free
Detector Phase	7	4		3	8		5	2		1	6	
Switch Phase												
Minimum Initial (s)	5.0	15.0		5.0	15.0		5.0	15.0		5.0	15.0	
Minimum Split (s)	10.0	23.0		10.0	23.0		10.0	23.0		10.0	23.0	
Total Split (s)	20.0	35.0		10.0	25.0		10.0	65.0		10.0	65.0	
Total Split (%)	16.7%	29.2%		8.3%	20.8%		8.3%	54.2%		8.3%	54.2%	
Yellow Time (s)	3.0	3.0		3.0	3.0		3.0	3.0		3.0	3.0	
All-Red Time (s)	2.0	2.0		2.0	2.0		2.0	2.0		2.0	2.0	
Lost Time Adjust (s)	0.0	0.0		0.0	0.0		0.0	0.0		0.0	0.0	
Total Lost Time (s)	5.0	5.0		5.0	5.0		5.0	5.0		5.0	5.0	
Lead/Lag	Lead	Lag		Lead	Lag		Lead	Lag		Lead	Lag	
Lead-Lag Optimize?	Yes	Yes		Yes	Yes		Yes	Yes		Yes	Yes	
Recall Mode	None	None		None	None		None	C-Max		None	C-Max	
Act Effct Green (s)	27.0	25.0	120.0	14.0	15.0	120.0	82.6	80.8	120.0	76.2	70.5	120.0
Actuated g/C Ratio	0.22	0.21	1.00	0.12	0.12	1.00	0.69	0.67	1.00	0.64	0.59	1.00
v/c Ratio	0.69	0.10	0.11	0.03	0.06	0.01	0.19	0.19	0.00	0.01	0.53	0.25
Control Delay	51.4	36.5	0.1	31.6	46.8	0.0	7.9	10.1	0.0	8.8	19.3	0.4
Queue Delay	0.0	0.0	0.0	0.0	0.0	0.0	0.0	0.0	0.0	0.0	0.0	0.0
Total Delay	51.4	36.5	0.1	31.6	46.8	0.0	7.9	10.1	0.0	8.8	19.3	0.4
LOS	D	D	A	C	D	A	A	B	A	A	B	A
Approach Delay		28.9			32.3			9.1			11.6	
Approach LOS		C			C			A			B	

Intersection Summary

Cycle Length: 120
 Actuated Cycle Length: 120
 Offset: 63 (53%), Referenced to phase 2:NBTL and 6:SBTL, Start of Green
 Natural Cycle: 70
 Control Type: Actuated-Coordinated
 Maximum v/c Ratio: 0.69
 Intersection Signal Delay: 15.6
 Intersection LOS: B
 Intersection Capacity Utilization 63.0%
 ICU Level of Service B
 Analysis Period (min) 15

Splits and Phases: 9: US 24 & Woodmen Rd

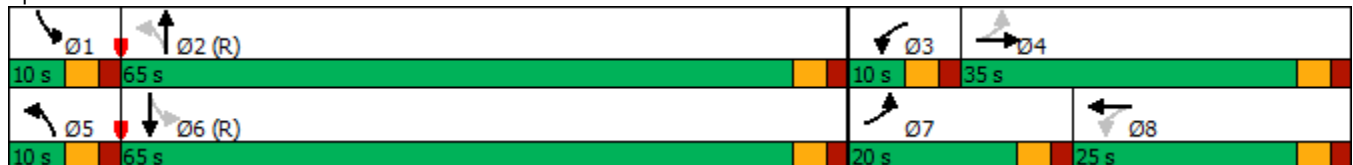

Intersection												
Int Delay, s/veh	0											
Movement	EBL	EBT	EBR	WBL	WBT	WBR	NBL	NBT	NBR	SBL	SBT	SBR
Lane Configurations			↗			↗		↖	↗		↖	↗
Traffic Vol, veh/h	0	0	25	0	0	51	0	328	29	0	705	4
Future Vol, veh/h	0	0	25	0	0	51	0	328	29	0	705	4
Conflicting Peds, #/hr	0	0	0	0	0	0	0	0	0	0	0	0
Sign Control	Stop	Stop	Stop	Stop	Stop	Stop	Free	Free	Free	Free	Free	Free
RT Channelized	-	-	Free	-	-	Free	-	-	None	-	-	None
Storage Length	-	-	0	-	-	0	-	-	400	-	-	400
Veh in Median Storage, #	-	0	-	-	0	-	-	0	-	-	0	-
Grade, %	-	0	-	-	0	-	-	0	-	-	0	-
Peak Hour Factor	91	91	91	91	91	91	91	91	91	91	91	91
Heavy Vehicles, %	2	2	2	2	2	2	2	2	2	2	2	2
Mvmt Flow	0	0	27	0	0	56	0	360	32	0	775	4

Major/Minor	Minor2		Minor1			Major1			Major2			
Conflicting Flow All	-	-	-	-	-	-	-	0	0	-	-	0
Stage 1	-	-	-	-	-	-	-	-	-	-	-	-
Stage 2	-	-	-	-	-	-	-	-	-	-	-	-
Critical Hdwy	-	-	-	-	-	-	-	-	-	-	-	-
Critical Hdwy Stg 1	-	-	-	-	-	-	-	-	-	-	-	-
Critical Hdwy Stg 2	-	-	-	-	-	-	-	-	-	-	-	-
Follow-up Hdwy	-	-	-	-	-	-	-	-	-	-	-	-
Pot Cap-1 Maneuver	0	0	0	0	0	0	0	-	-	0	-	-
Stage 1	0	0	0	0	0	0	0	-	-	0	-	-
Stage 2	0	0	0	0	0	0	0	-	-	0	-	-
Platoon blocked, %	-	-	-	-	-	-	-	-	-	-	-	-
Mov Cap-1 Maneuver	-	-	-	-	-	-	-	-	-	-	-	-
Mov Cap-2 Maneuver	-	-	-	-	-	-	-	-	-	-	-	-
Stage 1	-	-	-	-	-	-	-	-	-	-	-	-
Stage 2	-	-	-	-	-	-	-	-	-	-	-	-

Approach	EB	WB	NB	SB
HCM Control Delay, s	0	0	0	0
HCM LOS	A	A		

Minor Lane/Major Mvmt	NBT	NBR	EBLn1WBLn1	SBT	SBR
Capacity (veh/h)	-	-	-	-	-
HCM Lane V/C Ratio	-	-	-	-	-
HCM Control Delay (s)	-	-	0	0	-
HCM Lane LOS	-	-	A	A	-
HCM 95th %tile Q(veh)	-	-	-	-	-

Timings
7: Meridian Rd & Woodmen Rd

2028 Background Traffic
PM Peak Hour

Lane Group	EBL	EBT	EBR	WBL	WBT	WBR	NBL	NBT	NBR	SBL	SBT	SBR
Lane Configurations												
Traffic Volume (vph)	638	541	134	116	511	64	243	568	79	119	435	366
Future Volume (vph)	638	541	134	116	511	64	243	568	79	119	435	366
Turn Type	Prot	NA	Free	Prot	NA	Perm	Prot	NA	Free	Prot	NA	Free
Protected Phases	7	4		3	8		5	2		1	6	
Permitted Phases			Free			8			Free			Free
Detector Phase	7	4		3	8	8	5	2		1	6	
Switch Phase												
Minimum Initial (s)	5.0	15.0		5.0	15.0	15.0	5.0	15.0		5.0	15.0	
Minimum Split (s)	12.5	22.0		12.5	22.0	22.0	13.5	22.0		13.5	22.0	
Total Split (s)	25.0	33.0		15.0	23.0	23.0	18.0	27.0		15.0	24.0	
Total Split (%)	27.8%	36.7%		16.7%	25.6%	25.6%	20.0%	30.0%		16.7%	26.7%	
Yellow Time (s)	4.0	5.0		4.0	5.0	5.0	5.0	5.0		5.0	5.0	
All-Red Time (s)	3.5	2.0		3.5	2.0	2.0	3.5	2.0		3.5	2.0	
Lost Time Adjust (s)	0.0	0.0		0.0	0.0	0.0	0.0	0.0		0.0	0.0	
Total Lost Time (s)	7.5	7.0		7.5	7.0	7.0	8.5	7.0		8.5	7.0	
Lead/Lag	Lead	Lag		Lead	Lag	Lag	Lead	Lag		Lead	Lag	
Lead-Lag Optimize?	Yes	Yes		Yes	Yes	Yes	Yes	Yes		Yes	Yes	
Recall Mode	None	None		None	None	None	None	C-Max		None	C-Max	
Act Effct Green (s)	17.5	26.0	90.0	7.3	15.8	15.8	9.3	20.2	90.0	6.5	17.4	90.0
Actuated g/C Ratio	0.19	0.29	1.00	0.08	0.18	0.18	0.10	0.22	1.00	0.07	0.19	1.00
v/c Ratio	1.00	0.55	0.09	0.44	0.86	0.12	0.71	0.74	0.05	0.50	0.66	0.24
Control Delay	71.9	29.5	0.1	65.0	44.1	1.3	62.9	21.3	0.1	47.8	39.2	0.4
Queue Delay	0.0	0.0	0.0	0.0	0.0	0.0	0.0	0.0	0.0	0.0	0.0	0.0
Total Delay	71.9	29.5	0.1	65.0	44.1	1.3	62.9	21.3	0.1	47.8	39.2	0.4
LOS	E	C	A	E	D	A	E	C	A	D	D	A
Approach Delay		47.1			43.6			30.8			24.9	
Approach LOS		D			D			C			C	

Intersection Summary

Cycle Length: 90
 Actuated Cycle Length: 90
 Offset: 0 (0%), Referenced to phase 2:NBT and 6:SBT, Start of FDW or yellow, Master Intersection
 Natural Cycle: 90
 Control Type: Actuated-Coordinated
 Maximum v/c Ratio: 1.00
 Intersection Signal Delay: 37.3
 Intersection LOS: D
 Intersection Capacity Utilization 76.8%
 ICU Level of Service D
 Analysis Period (min) 15

Splits and Phases: 7: Meridian Rd & Woodmen Rd

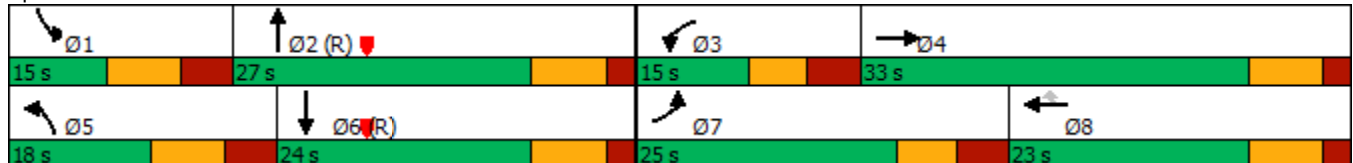

Timings
8: McLaughlin Rd & Woodmen Rd

2028 Background Traffic
PM Peak Hour

Lane Group	EBL	EBT	EBR	WBL	WBT	WBR	NBL	NBT	NBR	SBL	SBT	SBR
Lane Configurations												
Traffic Volume (vph)	296	346	97	45	411	266	86	165	87	185	113	194
Future Volume (vph)	296	346	97	45	411	266	86	165	87	185	113	194
Turn Type	pm+pt	NA	Perm	pm+pt	NA	Perm	pm+pt	NA	Perm	pm+pt	NA	Perm
Protected Phases	5	2		1	6		3	8		7	4	
Permitted Phases	2		2	6		6	8		8	4		4
Detector Phase	5	2	2	1	6	6	3	8	8	7	4	4
Switch Phase												
Minimum Initial (s)	5.0	5.0	5.0	5.0	5.0	5.0	5.0	5.0	5.0	5.0	5.0	5.0
Minimum Split (s)	12.5	25.0	25.0	12.5	25.0	25.0	13.5	25.0	25.0	13.5	25.0	25.0
Total Split (s)	14.0	37.0	37.0	14.0	37.0	37.0	14.0	25.0	25.0	14.0	25.0	25.0
Total Split (%)	15.6%	41.1%	41.1%	15.6%	41.1%	41.1%	15.6%	27.8%	27.8%	15.6%	27.8%	27.8%
Yellow Time (s)	4.0	5.0	5.0	4.0	5.0	5.0	5.0	5.0	5.0	5.0	5.0	5.0
All-Red Time (s)	3.5	2.0	2.0	3.5	2.0	2.0	3.5	2.0	2.0	3.5	2.0	2.0
Lost Time Adjust (s)	0.0	0.0	0.0	0.0	0.0	0.0	0.0	0.0	0.0	0.0	0.0	0.0
Total Lost Time (s)	7.5	7.0	7.0	7.5	7.0	7.0	8.5	7.0	7.0	8.5	7.0	7.0
Lead/Lag	Lead	Lag	Lag	Lead	Lag	Lag	Lead	Lag	Lag	Lead	Lag	Lag
Lead-Lag Optimize?	Yes	Yes	Yes	Yes	Yes	Yes	Yes	Yes	Yes	Yes	Yes	Yes
Recall Mode	None	C-Max	C-Max	None	C-Max	C-Max	None	Max	Max	None	Max	Max
Act Effct Green (s)	39.0	35.6	35.6	35.7	30.0	30.0	22.0	18.0	18.0	23.7	20.8	20.8
Actuated g/C Ratio	0.43	0.40	0.40	0.40	0.33	0.33	0.24	0.20	0.20	0.26	0.23	0.23
v/c Ratio	0.73	0.26	0.13	0.10	0.36	0.39	0.26	0.46	0.18	0.57	0.27	0.36
Control Delay	48.7	38.8	8.7	13.3	23.8	4.6	23.6	36.3	0.8	32.6	32.3	4.2
Queue Delay	0.0	0.0	0.0	0.0	0.0	0.0	0.0	0.0	0.0	0.0	0.0	0.0
Total Delay	48.7	38.8	8.7	13.3	23.8	4.6	23.6	36.3	0.8	32.6	32.3	4.2
LOS	D	D	A	B	C	A	C	D	A	C	C	A
Approach Delay		38.8			16.1			23.9			21.3	
Approach LOS		D			B			C			C	

Intersection Summary

Cycle Length: 90
 Actuated Cycle Length: 90
 Offset: 0 (0%), Referenced to phase 2:EBTL and 6:WBTL, Start of Green
 Natural Cycle: 80
 Control Type: Actuated-Coordinated
 Maximum v/c Ratio: 0.73
 Intersection Signal Delay: 25.7
 Intersection LOS: C
 Intersection Capacity Utilization 70.0%
 ICU Level of Service C
 Analysis Period (min) 15

Splits and Phases: 8: McLaughlin Rd & Woodmen Rd

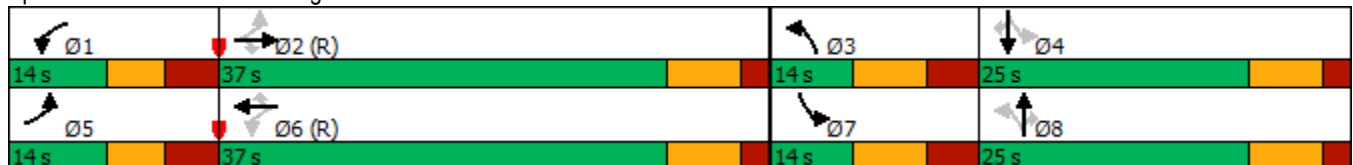

Timings
9: US 24 & Woodmen Rd

2028 Background Traffic
PM Peak Hour

Lane Group	EBL	EBT	EBR	WBL	WBT	WBR	NBL	NBT	NBR	SBL	SBT	SBR
Lane Configurations												
Traffic Volume (vph)	433	65	120	5	65	4	346	507	5	2	331	311
Future Volume (vph)	433	65	120	5	65	4	346	507	5	2	331	311
Turn Type	pm+pt	NA	Free	pm+pt	NA	Free	pm+pt	NA	Free	pm+pt	NA	Free
Protected Phases	7	4		3	8		5	2		1	6	
Permitted Phases	4		Free	8		Free	2		Free	6		Free
Detector Phase	7	4		3	8		5	2		1	6	
Switch Phase												
Minimum Initial (s)	5.0	15.0		5.0	15.0		5.0	15.0		5.0	15.0	
Minimum Split (s)	10.0	23.0		10.0	23.0		10.0	23.0		10.0	23.0	
Total Split (s)	31.0	46.0		10.0	25.0		15.0	54.0		10.0	49.0	
Total Split (%)	25.8%	38.3%		8.3%	20.8%		12.5%	45.0%		8.3%	40.8%	
Yellow Time (s)	3.0	3.0		3.0	3.0		3.0	3.0		3.0	3.0	
All-Red Time (s)	2.0	2.0		2.0	2.0		2.0	2.0		2.0	2.0	
Lost Time Adjust (s)	0.0	0.0		0.0	0.0		0.0	0.0		0.0	0.0	
Total Lost Time (s)	5.0	5.0		5.0	5.0		5.0	5.0		5.0	5.0	
Lead/Lag	Lead	Lag		Lead	Lag		Lead	Lag		Lead	Lag	
Lead-Lag Optimize?	Yes	Yes		Yes	Yes		Yes	Yes		Yes	Yes	
Recall Mode	None	None		None	None		None	C-Max		None	C-Max	
Act Effct Green (s)	42.0	40.0	120.0	17.0	15.0	120.0	68.0	65.8	120.0	56.1	50.5	120.0
Actuated g/C Ratio	0.35	0.33	1.00	0.14	0.12	1.00	0.57	0.55	1.00	0.47	0.42	1.00
v/c Ratio	0.88	0.11	0.08	0.02	0.16	0.00	0.45	0.58	0.00	0.01	0.49	0.23
Control Delay	52.6	27.5	0.1	26.0	48.0	0.0	15.5	23.2	0.0	14.0	30.2	0.3
Queue Delay	0.0	0.0	0.0	0.0	0.0	0.0	0.0	0.0	0.0	0.0	0.0	0.0
Total Delay	52.6	27.5	0.1	26.0	48.0	0.0	15.5	23.2	0.0	14.0	30.2	0.3
LOS	D	C	A	C	D	A	B	C	A	B	C	A
Approach Delay		39.7			44.2			19.9			15.7	
Approach LOS		D			D			B			B	

Intersection Summary

Cycle Length: 120
 Actuated Cycle Length: 120
 Offset: 63 (53%), Referenced to phase 2:NBTL and 6:SBTL, Start of Green
 Natural Cycle: 80
 Control Type: Actuated-Coordinated
 Maximum v/c Ratio: 0.88
 Intersection Signal Delay: 24.6
 Intersection Capacity Utilization 74.0%
 Analysis Period (min) 15
 Intersection LOS: C
 ICU Level of Service D

Splits and Phases: 9: US 24 & Woodmen Rd

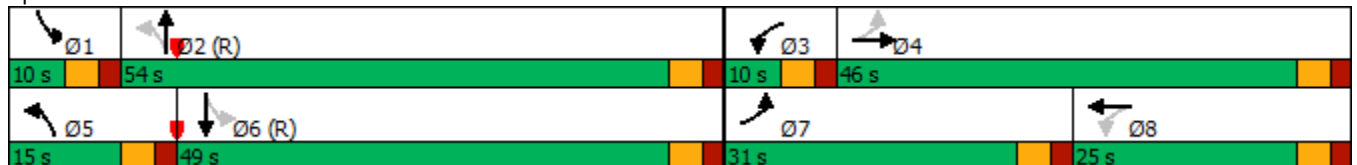

Timings
10: US 24 & Meridian Rd

2028 Background Traffic
PM Peak Hour

Lane Group	EBL	EBT	EBR	WBL	WBT	WBR	NBL	NBT	NBR	SBL	SBT	SBR
Lane Configurations												
Traffic Volume (vph)	19	259	307	32	374	48	608	743	12	89	407	7
Future Volume (vph)	19	259	307	32	374	48	608	743	12	89	407	7
Turn Type	pm+pt	NA	Free	pm+pt	NA	Free	Prot	NA	Perm	pm+pt	NA	Perm
Protected Phases	5	2		1	6		3	8		7	4	
Permitted Phases	2		Free	6		Free			8	4		4
Detector Phase	5	2		1	6		3	8	8	7	4	4
Switch Phase												
Minimum Initial (s)	5.0	5.0		5.0	5.0		5.0	5.0	5.0	5.0	5.0	5.0
Minimum Split (s)	11.0	20.0		11.0	20.0		11.0	20.0	20.0	11.0	20.0	20.0
Total Split (s)	11.0	20.0		11.0	20.0		25.0	47.0	47.0	12.0	34.0	34.0
Total Split (%)	12.2%	22.2%		12.2%	22.2%		27.8%	52.2%	52.2%	13.3%	37.8%	37.8%
Yellow Time (s)	3.0	5.0		3.0	5.0		3.0	4.5	4.5	3.0	4.5	4.5
All-Red Time (s)	3.0	2.0		3.0	2.0		3.0	2.0	2.0	3.0	2.0	2.0
Lost Time Adjust (s)	0.0	0.0		0.0	0.0		0.0	0.0	0.0	0.0	0.0	0.0
Total Lost Time (s)	6.0	7.0		6.0	7.0		6.0	6.5	6.5	6.0	6.5	6.5
Lead/Lag	Lead	Lag		Lead	Lag		Lead	Lag	Lag	Lead	Lag	Lag
Lead-Lag Optimize?	Yes	Yes		Yes	Yes		Yes	Yes	Yes	Yes	Yes	Yes
Recall Mode	None	C-Max		None	C-Max		None	None	None	None	None	None
Act Effct Green (s)	23.4	19.4	90.0	24.6	21.6	90.0	18.8	40.9	40.9	32.2	25.7	25.7
Actuated g/C Ratio	0.26	0.22	1.00	0.27	0.24	1.00	0.21	0.45	0.45	0.36	0.29	0.29
v/c Ratio	0.07	0.36	0.21	0.11	0.47	0.03	0.90	0.93	0.02	0.48	0.82	0.01
Control Delay	25.9	32.4	0.3	25.1	34.1	0.0	52.6	43.7	0.0	20.8	43.2	0.0
Queue Delay	0.0	0.0	0.0	0.0	0.0	0.0	0.0	0.0	0.0	0.0	0.0	0.0
Total Delay	25.9	32.4	0.3	25.1	34.1	0.0	52.6	43.7	0.0	20.8	43.2	0.0
LOS	C	C	A	C	C	A	D	D	A	C	D	A
Approach Delay		15.4			29.9			47.3			38.6	
Approach LOS		B			C			D			D	

Intersection Summary

Cycle Length: 90
 Actuated Cycle Length: 90
 Offset: 71 (79%), Referenced to phase 2:EBTL and 6:WBTL, Start of FDW or yellow
 Natural Cycle: 90
 Control Type: Actuated-Coordinated
 Maximum v/c Ratio: 0.93
 Intersection Signal Delay: 36.6
 Intersection LOS: D
 Intersection Capacity Utilization 79.8%
 ICU Level of Service D
 Analysis Period (min) 15

Splits and Phases: 10: US 24 & Meridian Rd

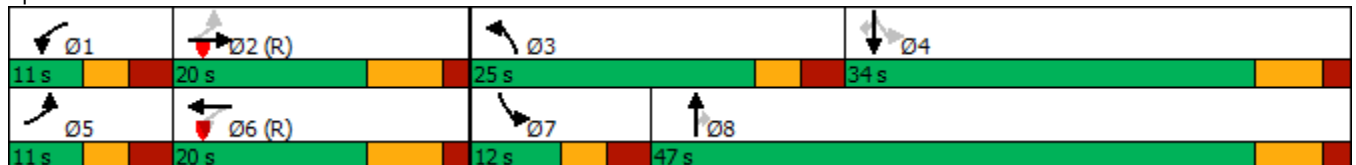

Intersection												
Int Delay, s/veh	0											
Movement	EBL	EBT	EBR	WBL	WBT	WBR	NBL	NBT	NBR	SBL	SBT	SBR
Lane Configurations			↗			↗		↖	↗		↖	↗
Traffic Vol, veh/h	0	0	52	0	0	73	0	785	25	0	451	5
Future Vol, veh/h	0	0	52	0	0	73	0	785	25	0	451	5
Conflicting Peds, #/hr	0	0	0	0	0	0	0	0	0	0	0	0
Sign Control	Stop	Stop	Stop	Stop	Stop	Stop	Free	Free	Free	Free	Free	Free
RT Channelized	-	-	Free	-	-	Free	-	-	None	-	-	None
Storage Length	-	-	0	-	-	0	-	-	400	-	-	400
Veh in Median Storage, #	-	0	-	-	0	-	-	0	-	-	0	-
Grade, %	-	0	-	-	0	-	-	0	-	-	0	-
Peak Hour Factor	90	90	90	90	90	90	90	90	90	90	90	90
Heavy Vehicles, %	2	2	2	2	2	2	2	2	2	2	2	2
Mvmt Flow	0	0	58	0	0	81	0	872	28	0	501	6

Major/Minor	Minor2		Minor1			Major1			Major2			
Conflicting Flow All	-	-	-	-	-	-	-	0	0	-	-	0
Stage 1	-	-	-	-	-	-	-	-	-	-	-	-
Stage 2	-	-	-	-	-	-	-	-	-	-	-	-
Critical Hdwy	-	-	-	-	-	-	-	-	-	-	-	-
Critical Hdwy Stg 1	-	-	-	-	-	-	-	-	-	-	-	-
Critical Hdwy Stg 2	-	-	-	-	-	-	-	-	-	-	-	-
Follow-up Hdwy	-	-	-	-	-	-	-	-	-	-	-	-
Pot Cap-1 Maneuver	0	0	0	0	0	0	0	-	-	0	-	-
Stage 1	0	0	0	0	0	0	0	-	-	0	-	-
Stage 2	0	0	0	0	0	0	0	-	-	0	-	-
Platoon blocked, %	-	-	-	-	-	-	-	-	-	-	-	-
Mov Cap-1 Maneuver	-	-	-	-	-	-	-	-	-	-	-	-
Mov Cap-2 Maneuver	-	-	-	-	-	-	-	-	-	-	-	-
Stage 1	-	-	-	-	-	-	-	-	-	-	-	-
Stage 2	-	-	-	-	-	-	-	-	-	-	-	-

Approach	EB		WB			NB			SB		
HCM Control Delay, s	0		0			0			0		
HCM LOS	A		A								

Minor Lane/Major Mvmt	NBT	NBR	EBLn1WBLn1	SBT	SBR
Capacity (veh/h)	-	-	-	-	-
HCM Lane V/C Ratio	-	-	-	-	-
HCM Control Delay (s)	-	-	0	0	-
HCM Lane LOS	-	-	A	A	-
HCM 95th %tile Q(veh)	-	-	-	-	-

Intersection												
Int Delay, s/veh	7.4											
Movement	EBL	EBT	EBR	WBL	WBT	WBR	NBL	NBT	NBR	SBL	SBT	SBR
Lane Configurations	↶	↷		↶	↷			↕			↕	
Traffic Vol, veh/h	0	0	0	16	0	11	0	0	49	22	0	0
Future Vol, veh/h	0	0	0	16	0	11	0	0	49	22	0	0
Conflicting Peds, #/hr	0	0	0	0	0	0	0	0	0	0	0	0
Sign Control	Free	Free	Free	Free	Free	Free	Stop	Stop	Stop	Stop	Stop	Stop
RT Channelized	-	-	None	-	-	None	-	-	None	-	-	None
Storage Length	135	-	-	190	-	-	-	-	-	-	-	-
Veh in Median Storage, #	-	0	-	-	0	-	-	0	-	-	0	-
Grade, %	-	0	-	-	0	-	-	0	-	-	0	-
Peak Hour Factor	92	92	92	92	92	92	92	92	92	92	92	92
Heavy Vehicles, %	2	2	2	2	2	2	2	2	2	2	2	2
Mvmt Flow	0	0	0	17	0	12	0	0	53	24	0	0

Major/Minor	Major1		Major2		Minor1		Minor2					
Conflicting Flow All	12	0	0	1	0	0	41	47	1	68	41	6
Stage 1	-	-	-	-	-	-	1	1	-	40	40	-
Stage 2	-	-	-	-	-	-	40	46	-	28	1	-
Critical Hdwy	4.12	-	-	4.12	-	-	7.12	6.52	6.22	7.12	6.52	6.22
Critical Hdwy Stg 1	-	-	-	-	-	-	6.12	5.52	-	6.12	5.52	-
Critical Hdwy Stg 2	-	-	-	-	-	-	6.12	5.52	-	6.12	5.52	-
Follow-up Hdwy	2.218	-	-	2.218	-	-	3.518	4.018	3.318	3.518	4.018	3.318
Pot Cap-1 Maneuver	1607	-	-	1622	-	-	963	845	1084	925	851	1077
Stage 1	-	-	-	-	-	-	1022	895	-	975	862	-
Stage 2	-	-	-	-	-	-	975	857	-	989	895	-
Platoon blocked, %	-	-	-	-	-	-	-	-	-	-	-	-
Mov Cap-1 Maneuver	1607	-	-	1622	-	-	955	837	1084	872	842	1077
Mov Cap-2 Maneuver	-	-	-	-	-	-	955	837	-	872	842	-
Stage 1	-	-	-	-	-	-	1022	895	-	975	853	-
Stage 2	-	-	-	-	-	-	965	848	-	940	895	-

Approach	EB		WB		NB		SB	
HCM Control Delay, s	0		4.3		8.5		9.2	
HCM LOS					A		A	

Minor Lane/Major Mvmt	NBLn1	EBL	EBT	EBR	WBL	WBT	WBR	SBLn1
Capacity (veh/h)	1084	1607	-	-	1622	-	-	872
HCM Lane V/C Ratio	0.049	-	-	-	0.011	-	-	0.027
HCM Control Delay (s)	8.5	0	-	-	7.2	-	-	9.2
HCM Lane LOS	A	A	-	-	A	-	-	A
HCM 95th %tile Q(veh)	0.2	0	-	-	0	-	-	0.1

Intersection						
Int Delay, s/veh	2.7					
Movement	EBL	EBT	WBT	WBR	SBL	SBR
Lane Configurations						
Traffic Vol, veh/h	45	63	82	0	0	30
Future Vol, veh/h	45	63	82	0	0	30
Conflicting Peds, #/hr	0	0	0	0	0	0
Sign Control	Free	Free	Free	Free	Stop	Stop
RT Channelized	-	None	-	None	-	None
Storage Length	120	-	-	-	0	-
Veh in Median Storage, #	-	0	0	-	0	-
Grade, %	-	0	0	-	0	-
Peak Hour Factor	92	92	92	92	92	92
Heavy Vehicles, %	2	2	2	2	2	2
Mvmt Flow	49	68	89	0	0	33

Major/Minor	Major1	Major2	Minor2		
Conflicting Flow All	89	0	-	0	255 89
Stage 1	-	-	-	-	89 -
Stage 2	-	-	-	-	166 -
Critical Hdwy	4.12	-	-	-	6.42 6.22
Critical Hdwy Stg 1	-	-	-	-	5.42 -
Critical Hdwy Stg 2	-	-	-	-	5.42 -
Follow-up Hdwy	2.218	-	-	-	3.518 3.318
Pot Cap-1 Maneuver	1506	-	-	-	734 969
Stage 1	-	-	-	-	934 -
Stage 2	-	-	-	-	863 -
Platoon blocked, %		-	-	-	
Mov Cap-1 Maneuver	1506	-	-	-	710 969
Mov Cap-2 Maneuver	-	-	-	-	710 -
Stage 1	-	-	-	-	903 -
Stage 2	-	-	-	-	863 -

Approach	EB	WB	SB
HCM Control Delay, s	3.1	0	8.8
HCM LOS			A

Minor Lane/Major Mvmt	EBL	EBT	WBT	WBR	SBLn1
Capacity (veh/h)	1506	-	-	-	969
HCM Lane V/C Ratio	0.032	-	-	-	0.034
HCM Control Delay (s)	7.5	-	-	-	8.8
HCM Lane LOS	A	-	-	-	A
HCM 95th %tile Q(veh)	0.1	-	-	-	0.1

Intersection						
Int Delay, s/veh	1.9					
Movement	EBT	EBR	WBL	WBT	NBL	NBR
Lane Configurations						
Traffic Vol, veh/h	52	10	0	56	30	1
Future Vol, veh/h	52	10	0	56	30	1
Conflicting Peds, #/hr	0	0	0	0	0	0
Sign Control	Free	Free	Free	Free	Stop	Stop
RT Channelized	-	None	-	None	-	None
Storage Length	-	-	-	-	0	-
Veh in Median Storage, #	0	-	-	0	0	-
Grade, %	0	-	-	0	0	-
Peak Hour Factor	92	92	92	92	92	92
Heavy Vehicles, %	2	2	2	2	2	2
Mvmt Flow	57	11	0	61	33	1

Major/Minor	Major1	Major2	Minor1			
Conflicting Flow All	0	0	68	0	124	63
Stage 1	-	-	-	-	63	-
Stage 2	-	-	-	-	61	-
Critical Hdwy	-	-	4.12	-	6.42	6.22
Critical Hdwy Stg 1	-	-	-	-	5.42	-
Critical Hdwy Stg 2	-	-	-	-	5.42	-
Follow-up Hdwy	-	-	2.218	-	3.518	3.318
Pot Cap-1 Maneuver	-	-	1533	-	871	1002
Stage 1	-	-	-	-	960	-
Stage 2	-	-	-	-	962	-
Platoon blocked, %	-	-	-	-	-	-
Mov Cap-1 Maneuver	-	-	1533	-	871	1002
Mov Cap-2 Maneuver	-	-	-	-	871	-
Stage 1	-	-	-	-	960	-
Stage 2	-	-	-	-	962	-

Approach	EB	WB	NB
HCM Control Delay, s	0	0	9.3
HCM LOS			A

Minor Lane/Major Mvmt	NBLn1	EBT	EBR	WBL	WBT
Capacity (veh/h)	875	-	-	1533	-
HCM Lane V/C Ratio	0.039	-	-	-	-
HCM Control Delay (s)	9.3	-	-	0	-
HCM Lane LOS	A	-	-	A	-
HCM 95th %tile Q(veh)	0.1	-	-	0	-

Intersection						
Int Delay, s/veh	0.8					
Movement	EBT	EBR	WBL	WBT	NBL	NBR
Lane Configurations						
Traffic Vol, veh/h	50	2	1	49	7	2
Future Vol, veh/h	50	2	1	49	7	2
Conflicting Peds, #/hr	0	0	0	0	0	0
Sign Control	Free	Free	Free	Free	Stop	Stop
RT Channelized	-	None	-	None	-	None
Storage Length	-	-	-	-	0	-
Veh in Median Storage, #	0	-	-	0	0	-
Grade, %	0	-	-	0	0	-
Peak Hour Factor	92	92	92	92	92	92
Heavy Vehicles, %	2	2	2	2	2	2
Mvmt Flow	54	2	1	53	8	2

Major/Minor	Major1	Major2	Minor1	Minor2	Minor3
Conflicting Flow All	0	0	56	0	110
Stage 1	-	-	-	-	55
Stage 2	-	-	-	-	55
Critical Hdwy	-	-	4.12	-	6.42
Critical Hdwy Stg 1	-	-	-	-	5.42
Critical Hdwy Stg 2	-	-	-	-	5.42
Follow-up Hdwy	-	-	2.218	-	3.518
Pot Cap-1 Maneuver	-	-	1549	-	887
Stage 1	-	-	-	-	968
Stage 2	-	-	-	-	968
Platoon blocked, %	-	-	-	-	-
Mov Cap-1 Maneuver	-	-	1549	-	886
Mov Cap-2 Maneuver	-	-	-	-	886
Stage 1	-	-	-	-	968
Stage 2	-	-	-	-	967

Approach	EB	WB	NB
HCM Control Delay, s	0	0.1	9
HCM LOS			A

Minor Lane/Major Mvmt	NBLn1	EBT	EBR	WBL	WBT
Capacity (veh/h)	911	-	-	1549	-
HCM Lane V/C Ratio	0.011	-	-	0.001	-
HCM Control Delay (s)	9	-	-	7.3	0
HCM Lane LOS	A	-	-	A	A
HCM 95th %tile Q(veh)	0	-	-	0	-

Timings
8: McLaughlin Rd & Woodmen Rd

2028 Total Traffic
AM Peak Hour

Lane Group	EBL	EBT	EBR	WBL	WBT	WBR	NBL	NBT	NBR	SBL	SBT	SBR
Lane Configurations												
Traffic Volume (vph)	101	318	46	28	426	152	39	45	10	130	125	293
Future Volume (vph)	101	318	46	28	426	152	39	45	10	130	125	293
Turn Type	pm+pt	NA	Perm	pm+pt	NA	Perm	pm+pt	NA	Perm	pm+pt	NA	Perm
Protected Phases	5	2		1	6		3	8		7	4	
Permitted Phases	2		2	6		6	8		8	4		4
Detector Phase	5	2	2	1	6	6	3	8	8	7	4	4
Switch Phase												
Minimum Initial (s)	5.0	5.0	5.0	5.0	5.0	5.0	5.0	5.0	5.0	5.0	5.0	5.0
Minimum Split (s)	12.5	25.0	25.0	12.5	25.0	25.0	13.5	25.0	25.0	13.5	25.0	25.0
Total Split (s)	14.0	37.0	37.0	14.0	37.0	37.0	14.0	25.0	25.0	14.0	25.0	25.0
Total Split (%)	15.6%	41.1%	41.1%	15.6%	41.1%	41.1%	15.6%	27.8%	27.8%	15.6%	27.8%	27.8%
Yellow Time (s)	4.0	5.0	5.0	4.0	5.0	5.0	5.0	5.0	5.0	5.0	5.0	5.0
All-Red Time (s)	3.5	2.0	2.0	3.5	2.0	2.0	3.5	2.0	2.0	3.5	2.0	2.0
Lost Time Adjust (s)	0.0	0.0	0.0	0.0	0.0	0.0	0.0	0.0	0.0	0.0	0.0	0.0
Total Lost Time (s)	7.5	7.0	7.0	7.5	7.0	7.0	8.5	7.0	7.0	8.5	7.0	7.0
Lead/Lag	Lead	Lag	Lag	Lead	Lag	Lag	Lead	Lag	Lag	Lead	Lag	Lag
Lead-Lag Optimize?	Yes	Yes	Yes	Yes	Yes	Yes	Yes	Yes	Yes	Yes	Yes	Yes
Recall Mode	None	C-Max	C-Max	None	C-Max	C-Max	None	Max	Max	None	Max	Max
Act Effct Green (s)	40.5	38.4	38.4	37.3	32.8	32.8	22.0	18.0	18.0	25.4	23.6	23.6
Actuated g/C Ratio	0.45	0.43	0.43	0.41	0.36	0.36	0.24	0.20	0.20	0.28	0.26	0.26
v/c Ratio	0.24	0.21	0.06	0.06	0.34	0.21	0.12	0.12	0.02	0.35	0.26	0.47
Control Delay	33.0	38.0	4.0	13.0	22.7	1.0	21.6	30.7	0.1	25.8	30.7	6.7
Queue Delay	0.0	0.0	0.0	0.0	0.0	0.0	0.0	0.0	0.0	0.0	0.0	0.0
Total Delay	33.0	38.0	4.0	13.0	22.7	1.0	21.6	30.7	0.1	25.8	30.7	6.7
LOS	C	D	A	B	C	A	C	C	A	C	C	A
Approach Delay		33.5			16.8			23.7			16.7	
Approach LOS		C			B			C			B	

Intersection Summary

Cycle Length: 90
 Actuated Cycle Length: 90
 Offset: 0 (0%), Referenced to phase 2:EBTL and 6:WBTL, Start of Green
 Natural Cycle: 80
 Control Type: Actuated-Coordinated
 Maximum v/c Ratio: 0.47
 Intersection Signal Delay: 21.7
 Intersection LOS: C
 Intersection Capacity Utilization 52.5%
 ICU Level of Service A
 Analysis Period (min) 15

Splits and Phases: 8: McLaughlin Rd & Woodmen Rd

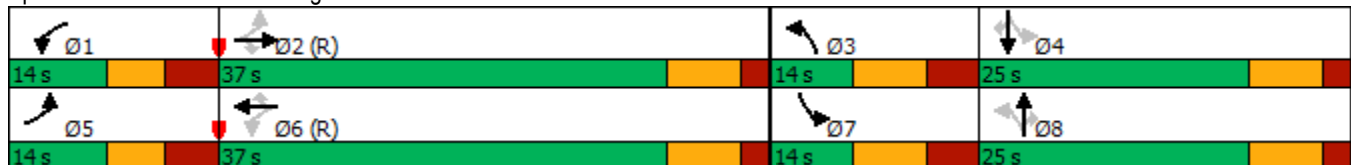

Intersection						
Int Delay, s/veh	0.4					
Movement	EBL	EBR	NBL	NBT	SBT	SBR
Lane Configurations	↔			↑	↑	
Traffic Vol, veh/h	2	1	4	60	81	4
Future Vol, veh/h	2	1	4	60	81	4
Conflicting Peds, #/hr	0	0	0	0	0	0
Sign Control	Stop	Stop	Free	Free	Free	Free
RT Channelized	-	None	-	None	-	None
Storage Length	0	-	-	-	-	-
Veh in Median Storage, #	0	-	-	0	0	-
Grade, %	0	-	-	0	0	-
Peak Hour Factor	92	92	92	92	92	92
Heavy Vehicles, %	2	2	2	2	2	2
Mvmt Flow	2	1	4	65	88	4

Major/Minor	Minor2	Major1		Major2	
Conflicting Flow All	163	90	92	0	0
Stage 1	90	-	-	-	-
Stage 2	73	-	-	-	-
Critical Hdwy	6.42	6.22	4.12	-	-
Critical Hdwy Stg 1	5.42	-	-	-	-
Critical Hdwy Stg 2	5.42	-	-	-	-
Follow-up Hdwy	3.518	3.318	2.218	-	-
Pot Cap-1 Maneuver	828	968	1503	-	-
Stage 1	934	-	-	-	-
Stage 2	950	-	-	-	-
Platoon blocked, %				-	-
Mov Cap-1 Maneuver	826	968	1503	-	-
Mov Cap-2 Maneuver	826	-	-	-	-
Stage 1	931	-	-	-	-
Stage 2	950	-	-	-	-

Approach	EB	NB	SB
HCM Control Delay, s	9.2	0.5	0
HCM LOS	A		

Minor Lane/Major Mvmt	NBL	NBT	EBLn1	SBT	SBR
Capacity (veh/h)	1503	-	868	-	-
HCM Lane V/C Ratio	0.003	-	0.004	-	-
HCM Control Delay (s)	7.4	-	9.2	-	-
HCM Lane LOS	A	-	A	-	-
HCM 95th %tile Q(veh)	0	-	0	-	-

Timings
10: US 24 & Meridian Rd

2028 Total Traffic
AM Peak Hour

Lane Group	EBL	EBT	EBR	WBL	WBT	WBR	NBL	NBT	NBR	SBL	SBT	SBR
Lane Configurations												
Traffic Volume (vph)	7	391	719	32	190	26	203	340	18	70	696	2
Future Volume (vph)	7	391	719	32	190	26	203	340	18	70	696	2
Turn Type	pm+pt	NA	Free	pm+pt	NA	Free	Prot	NA	Perm	pm+pt	NA	Perm
Protected Phases	5	2		1	6		3	8		7	4	
Permitted Phases	2		Free	6		Free			8	4		4
Detector Phase	5	2		1	6		3	8	8	7	4	4
Switch Phase												
Minimum Initial (s)	5.0	5.0		5.0	5.0		5.0	5.0	5.0	5.0	5.0	5.0
Minimum Split (s)	11.0	20.0		11.0	20.0		11.0	20.0	20.0	11.0	20.0	20.0
Total Split (s)	11.0	20.0		11.0	20.0		15.0	47.0	47.0	12.0	44.0	44.0
Total Split (%)	12.2%	22.2%		12.2%	22.2%		16.7%	52.2%	52.2%	13.3%	48.9%	48.9%
Yellow Time (s)	3.0	5.0		3.0	5.0		3.0	4.5	4.5	3.0	4.5	4.5
All-Red Time (s)	3.0	2.0		3.0	2.0		3.0	2.0	2.0	3.0	2.0	2.0
Lost Time Adjust (s)	0.0	0.0		0.0	0.0		0.0	0.0	0.0	0.0	0.0	0.0
Total Lost Time (s)	6.0	7.0		6.0	7.0		6.0	6.5	6.5	6.0	6.5	6.5
Lead/Lag	Lead	Lag		Lead	Lag		Lead	Lag	Lag	Lead	Lag	Lag
Lead-Lag Optimize?	Yes	Yes		Yes	Yes		Yes	Yes	Yes	Yes	Yes	Yes
Recall Mode	None	C-Max		None	C-Max		None	None	None	None	None	None
Act Effct Green (s)	22.7	18.7	90.0	25.1	23.1	90.0	8.7	41.6	41.6	42.8	36.4	36.4
Actuated g/C Ratio	0.25	0.21	1.00	0.28	0.26	1.00	0.10	0.46	0.46	0.48	0.40	0.40
v/c Ratio	0.02	0.54	0.46	0.13	0.21	0.02	0.62	0.40	0.02	0.14	0.94	0.00
Control Delay	26.6	36.5	1.9	25.4	29.0	0.0	47.7	18.2	0.1	9.1	48.2	0.0
Queue Delay	0.0	0.0	0.0	0.0	0.0	0.0	0.0	0.0	0.0	0.0	0.0	0.0
Total Delay	26.6	36.5	1.9	25.4	29.0	0.0	47.7	18.2	0.1	9.1	48.2	0.0
LOS	C	D	A	C	C	A	D	B	A	A	D	A
Approach Delay		14.2			25.5			28.3			44.6	
Approach LOS		B			C			C			D	

Intersection Summary

Cycle Length: 90
 Actuated Cycle Length: 90
 Offset: 71 (79%), Referenced to phase 2:EBTL and 6:WBTL, Start of FDW or yellow
 Natural Cycle: 80
 Control Type: Actuated-Coordinated
 Maximum v/c Ratio: 0.94
 Intersection Signal Delay: 26.8
 Intersection LOS: C
 Intersection Capacity Utilization 78.6%
 ICU Level of Service D
 Analysis Period (min) 15

Splits and Phases: 10: US 24 & Meridian Rd

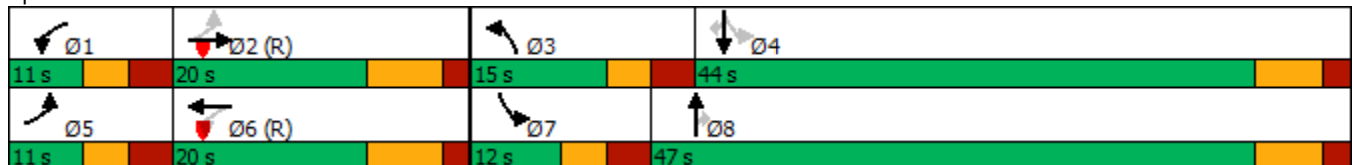

Intersection												
Int Delay, s/veh	0											
Movement	EBL	EBT	EBR	WBL	WBT	WBR	NBL	NBT	NBR	SBL	SBT	SBR
Lane Configurations			↗			↗		↖	↗		↖	↗
Traffic Vol, veh/h	0	0	25	0	0	51	0	344	29	0	743	4
Future Vol, veh/h	0	0	25	0	0	51	0	344	29	0	743	4
Conflicting Peds, #/hr	0	0	0	0	0	0	0	0	0	0	0	0
Sign Control	Stop	Stop	Stop	Stop	Stop	Stop	Free	Free	Free	Free	Free	Free
RT Channelized	-	-	Free	-	-	Free	-	-	None	-	-	None
Storage Length	-	-	0	-	-	0	-	-	400	-	-	400
Veh in Median Storage, #	-	0	-	-	0	-	-	0	-	-	0	-
Grade, %	-	0	-	-	0	-	-	0	-	-	0	-
Peak Hour Factor	91	91	91	91	91	91	91	91	91	91	91	91
Heavy Vehicles, %	2	2	2	2	2	2	2	2	2	2	2	2
Mvmt Flow	0	0	27	0	0	56	0	378	32	0	816	4

Major/Minor	Minor2		Minor1			Major1			Major2			
Conflicting Flow All	-	-	-	-	-	-	-	0	0	-	-	0
Stage 1	-	-	-	-	-	-	-	-	-	-	-	-
Stage 2	-	-	-	-	-	-	-	-	-	-	-	-
Critical Hdwy	-	-	-	-	-	-	-	-	-	-	-	-
Critical Hdwy Stg 1	-	-	-	-	-	-	-	-	-	-	-	-
Critical Hdwy Stg 2	-	-	-	-	-	-	-	-	-	-	-	-
Follow-up Hdwy	-	-	-	-	-	-	-	-	-	-	-	-
Pot Cap-1 Maneuver	0	0	0	0	0	0	0	-	-	0	-	-
Stage 1	0	0	0	0	0	0	0	-	-	0	-	-
Stage 2	0	0	0	0	0	0	0	-	-	0	-	-
Platoon blocked, %	-	-	-	-	-	-	-	-	-	-	-	-
Mov Cap-1 Maneuver	-	-	-	-	-	-	-	-	-	-	-	-
Mov Cap-2 Maneuver	-	-	-	-	-	-	-	-	-	-	-	-
Stage 1	-	-	-	-	-	-	-	-	-	-	-	-
Stage 2	-	-	-	-	-	-	-	-	-	-	-	-

Approach	EB	WB	NB	SB
HCM Control Delay, s	0	0	0	0
HCM LOS	A	A		

Minor Lane/Major Mvmt	NBT	NBR	EBLn1WBLn1	SBT	SBR
Capacity (veh/h)	-	-	-	-	-
HCM Lane V/C Ratio	-	-	-	-	-
HCM Control Delay (s)	-	-	0	0	-
HCM Lane LOS	-	-	A	A	-
HCM 95th %tile Q(veh)	-	-	-	-	-

Intersection												
Int Delay, s/veh	7.8											
Movement	EBL	EBT	EBR	WBL	WBT	WBR	NBL	NBT	NBR	SBL	SBT	SBR
Lane Configurations	↖	↗		↖	↗			↕			↕	
Traffic Vol, veh/h	0	0	0	53	0	23	0	0	21	85	0	0
Future Vol, veh/h	0	0	0	53	0	23	0	0	21	85	0	0
Conflicting Peds, #/hr	0	0	0	0	0	0	0	0	0	0	0	0
Sign Control	Free	Free	Free	Free	Free	Free	Stop	Stop	Stop	Stop	Stop	Stop
RT Channelized	-	-	None	-	-	None	-	-	None	-	-	None
Storage Length	135	-	-	190	-	-	-	-	-	-	-	-
Veh in Median Storage, #	-	0	-	-	0	-	-	0	-	-	0	-
Grade, %	-	0	-	-	0	-	-	0	-	-	0	-
Peak Hour Factor	92	92	92	92	92	92	92	92	92	92	92	92
Heavy Vehicles, %	2	2	2	2	2	2	2	2	2	2	2	2
Mvmt Flow	0	0	0	58	0	25	0	0	23	92	0	0

Major/Minor	Major1			Major2			Minor1			Minor2		
Conflicting Flow All	25	0	0	1	0	0	130	142	1	142	130	13
Stage 1	-	-	-	-	-	-	1	1	-	129	129	-
Stage 2	-	-	-	-	-	-	129	141	-	13	1	-
Critical Hdwy	4.12	-	-	4.12	-	-	7.12	6.52	6.22	7.12	6.52	6.22
Critical Hdwy Stg 1	-	-	-	-	-	-	6.12	5.52	-	6.12	5.52	-
Critical Hdwy Stg 2	-	-	-	-	-	-	6.12	5.52	-	6.12	5.52	-
Follow-up Hdwy	2.218	-	-	2.218	-	-	3.518	4.018	3.318	3.518	4.018	3.318
Pot Cap-1 Maneuver	1589	-	-	1622	-	-	843	749	1084	828	761	1067
Stage 1	-	-	-	-	-	-	1022	895	-	875	789	-
Stage 2	-	-	-	-	-	-	875	780	-	1007	895	-
Platoon blocked, %	-	-	-	-	-	-	-	-	-	-	-	-
Mov Cap-1 Maneuver	1589	-	-	1622	-	-	820	722	1084	788	734	1067
Mov Cap-2 Maneuver	-	-	-	-	-	-	820	722	-	788	734	-
Stage 1	-	-	-	-	-	-	1022	895	-	875	761	-
Stage 2	-	-	-	-	-	-	844	752	-	986	895	-

Approach	EB			WB			NB			SB		
HCM Control Delay, s	0			5.1			8.4			10.2		
HCM LOS							A			B		

Minor Lane/Major Mvmt	NBLn1	EBL	EBT	EBR	WBL	WBT	WBR	SBLn1
Capacity (veh/h)	1084	1589	-	-	1622	-	-	788
HCM Lane V/C Ratio	0.021	-	-	-	0.036	-	-	0.117
HCM Control Delay (s)	8.4	0	-	-	7.3	-	-	10.2
HCM Lane LOS	A	A	-	-	A	-	-	B
HCM 95th %tile Q(veh)	0.1	0	-	-	0.1	-	-	0.4

Intersection						
Int Delay, s/veh	4.3					
Movement	EBL	EBT	WBT	WBR	SBL	SBR
Lane Configurations						
Traffic Vol, veh/h	105	121	104	1	1	113
Future Vol, veh/h	105	121	104	1	1	113
Conflicting Peds, #/hr	0	0	0	0	0	0
Sign Control	Free	Free	Free	Free	Stop	Stop
RT Channelized	-	None	-	None	-	None
Storage Length	120	-	-	-	0	-
Veh in Median Storage, #	-	0	0	-	0	-
Grade, %	-	0	0	-	0	-
Peak Hour Factor	92	92	92	92	92	92
Heavy Vehicles, %	2	2	2	2	2	2
Mvmt Flow	114	132	113	1	1	123

Major/Minor	Major1	Major2	Minor2		
Conflicting Flow All	114	0	-	0	474 114
Stage 1	-	-	-	-	114 -
Stage 2	-	-	-	-	360 -
Critical Hdwy	4.12	-	-	-	6.42 6.22
Critical Hdwy Stg 1	-	-	-	-	5.42 -
Critical Hdwy Stg 2	-	-	-	-	5.42 -
Follow-up Hdwy	2.218	-	-	-	3.518 3.318
Pot Cap-1 Maneuver	1475	-	-	-	549 939
Stage 1	-	-	-	-	911 -
Stage 2	-	-	-	-	706 -
Platoon blocked, %		-	-	-	
Mov Cap-1 Maneuver	1475	-	-	-	507 939
Mov Cap-2 Maneuver	-	-	-	-	507 -
Stage 1	-	-	-	-	841 -
Stage 2	-	-	-	-	706 -

Approach	EB	WB	SB
HCM Control Delay, s	3.6	0	9.5
HCM LOS			A

Minor Lane/Major Mvmt	EBL	EBT	WBT	WBR	SBLn1
Capacity (veh/h)	1475	-	-	-	932
HCM Lane V/C Ratio	0.077	-	-	-	0.133
HCM Control Delay (s)	7.6	-	-	-	9.5
HCM Lane LOS	A	-	-	-	A
HCM 95th %tile Q(veh)	0.3	-	-	-	0.5

Intersection						
Int Delay, s/veh	0.6					
Movement	EBT	EBR	WBL	WBT	NBL	NBR
Lane Configurations						
Traffic Vol, veh/h	95	31	1	91	13	0
Future Vol, veh/h	95	31	1	91	13	0
Conflicting Peds, #/hr	0	0	0	0	0	0
Sign Control	Free	Free	Free	Free	Stop	Stop
RT Channelized	-	None	-	None	-	None
Storage Length	-	-	-	-	0	-
Veh in Median Storage, #	0	-	-	0	0	-
Grade, %	0	-	-	0	0	-
Peak Hour Factor	92	92	92	92	92	92
Heavy Vehicles, %	2	2	2	2	2	2
Mvmt Flow	103	34	1	99	14	0

Major/Minor	Major1	Major2	Minor1		
Conflicting Flow All	0	0	137	0	221
Stage 1	-	-	-	-	120
Stage 2	-	-	-	-	101
Critical Hdwy	-	-	4.12	-	6.42
Critical Hdwy Stg 1	-	-	-	-	5.42
Critical Hdwy Stg 2	-	-	-	-	5.42
Follow-up Hdwy	-	-	2.218	-	3.518
Pot Cap-1 Maneuver	-	-	1447	-	767
Stage 1	-	-	-	-	905
Stage 2	-	-	-	-	923
Platoon blocked, %	-	-	-	-	-
Mov Cap-1 Maneuver	-	-	1447	-	766
Mov Cap-2 Maneuver	-	-	-	-	766
Stage 1	-	-	-	-	905
Stage 2	-	-	-	-	922

Approach	EB	WB	NB
HCM Control Delay, s	0	0.1	9.8
HCM LOS			A

Minor Lane/Major Mvmt	NBLn1	EBT	EBR	WBL	WBT
Capacity (veh/h)	766	-	-	1447	-
HCM Lane V/C Ratio	0.018	-	-	0.001	-
HCM Control Delay (s)	9.8	-	-	7.5	0
HCM Lane LOS	A	-	-	A	A
HCM 95th %tile Q(veh)	0.1	-	-	0	-

Intersection						
Int Delay, s/veh	0.3					
Movement	EBT	EBR	WBL	WBT	NBL	NBR
Lane Configurations						
Traffic Vol, veh/h	88	7	2	88	3	1
Future Vol, veh/h	88	7	2	88	3	1
Conflicting Peds, #/hr	0	0	0	0	0	0
Sign Control	Free	Free	Free	Free	Stop	Stop
RT Channelized	-	None	-	None	-	None
Storage Length	-	-	-	-	0	-
Veh in Median Storage, #	0	-	-	0	0	-
Grade, %	0	-	-	0	0	-
Peak Hour Factor	92	92	92	92	92	92
Heavy Vehicles, %	2	2	2	2	2	2
Mvmt Flow	96	8	2	96	3	1

Major/Minor	Major1	Major2	Minor1		
Conflicting Flow All	0	0	104	0	200
Stage 1	-	-	-	-	100
Stage 2	-	-	-	-	100
Critical Hdwy	-	-	4.12	-	6.42
Critical Hdwy Stg 1	-	-	-	-	5.42
Critical Hdwy Stg 2	-	-	-	-	5.42
Follow-up Hdwy	-	-	2.218	-	3.518
Pot Cap-1 Maneuver	-	-	1488	-	789
Stage 1	-	-	-	-	924
Stage 2	-	-	-	-	924
Platoon blocked, %	-	-	-	-	-
Mov Cap-1 Maneuver	-	-	1488	-	788
Mov Cap-2 Maneuver	-	-	-	-	788
Stage 1	-	-	-	-	924
Stage 2	-	-	-	-	923

Approach	EB	WB	NB
HCM Control Delay, s	0	0.2	9.4
HCM LOS			A

Minor Lane/Major Mvmt	NBLn1	EBT	EBR	WBL	WBT
Capacity (veh/h)	824	-	-	1488	-
HCM Lane V/C Ratio	0.005	-	-	0.001	-
HCM Control Delay (s)	9.4	-	-	7.4	0
HCM Lane LOS	A	-	-	A	A
HCM 95th %tile Q(veh)	0	-	-	0	-

Timings
7: Meridian Rd & Woodmen Rd

2028 Total Traffic
PM Peak Hour

Lane Group	EBL	EBT	EBR	WBL	WBT	WBR	NBL	NBT	NBR	SBL	SBT	SBR
Lane Configurations												
Traffic Volume (vph)	638	586	131	122	538	114	248	547	85	159	422	366
Future Volume (vph)	638	586	131	122	538	114	248	547	85	159	422	366
Turn Type	Prot	NA	Free	Prot	NA	Perm	Prot	NA	Free	Prot	NA	Free
Protected Phases	7	4		3	8		5	2		1	6	
Permitted Phases			Free			8			Free			Free
Detector Phase	7	4		3	8	8	5	2		1	6	
Switch Phase												
Minimum Initial (s)	5.0	15.0		5.0	15.0	15.0	5.0	15.0		5.0	15.0	
Minimum Split (s)	12.5	22.0		12.5	22.0	22.0	13.5	22.0		13.5	22.0	
Total Split (s)	25.0	33.0		15.0	23.0	23.0	18.0	27.0		15.0	24.0	
Total Split (%)	27.8%	36.7%		16.7%	25.6%	25.6%	20.0%	30.0%		16.7%	26.7%	
Yellow Time (s)	4.0	5.0		4.0	5.0	5.0	5.0	5.0		5.0	5.0	
All-Red Time (s)	3.5	2.0		3.5	2.0	2.0	3.5	2.0		3.5	2.0	
Lost Time Adjust (s)	0.0	0.0		0.0	0.0	0.0	0.0	0.0		0.0	0.0	
Total Lost Time (s)	7.5	7.0		7.5	7.0	7.0	8.5	7.0		8.5	7.0	
Lead/Lag	Lead	Lag		Lead	Lag	Lag	Lead	Lag		Lead	Lag	
Lead-Lag Optimize?	Yes	Yes		Yes	Yes	Yes	Yes	Yes		Yes	Yes	
Recall Mode	None	None		None	None	None	None	C-Max		None	C-Max	
Act Effct Green (s)	17.5	26.1	90.0	7.3	15.9	15.9	9.4	20.0	90.0	6.6	17.2	90.0
Actuated g/C Ratio	0.19	0.29	1.00	0.08	0.18	0.18	0.10	0.22	1.00	0.07	0.19	1.00
v/c Ratio	1.00	0.59	0.09	0.46	0.89	0.21	0.72	0.73	0.06	0.66	0.65	0.24
Control Delay	71.9	30.3	0.1	66.6	46.3	3.4	63.5	20.5	0.1	54.5	38.9	0.4
Queue Delay	0.0	0.0	0.0	0.0	0.0	0.0	0.0	0.0	0.0	0.0	0.0	0.0
Total Delay	71.9	30.3	0.1	66.6	46.3	3.4	63.5	20.5	0.1	54.5	38.9	0.4
LOS	E	C	A	E	D	A	E	C	A	D	D	A
Approach Delay		47.0			43.2			30.6			26.6	
Approach LOS		D			D			C			C	

Intersection Summary

Cycle Length: 90
 Actuated Cycle Length: 90
 Offset: 0 (0%), Referenced to phase 2:NBT and 6:SBT, Start of FDW or yellow, Master Intersection
 Natural Cycle: 90
 Control Type: Actuated-Coordinated
 Maximum v/c Ratio: 1.00
 Intersection Signal Delay: 37.7
 Intersection LOS: D
 Intersection Capacity Utilization 77.3%
 ICU Level of Service D
 Analysis Period (min) 15

Splits and Phases: 7: Meridian Rd & Woodmen Rd

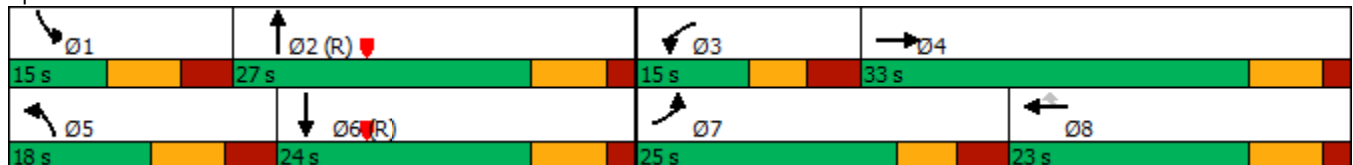

Timings
8: McLaughlin Rd & Woodmen Rd

2028 Total Traffic
PM Peak Hour

Lane Group	EBL	EBT	EBR	WBL	WBT	WBR	NBL	NBT	NBR	SBL	SBT	SBR
Lane Configurations												
Traffic Volume (vph)	296	438	97	45	494	282	86	165	87	202	113	194
Future Volume (vph)	296	438	97	45	494	282	86	165	87	202	113	194
Turn Type	pm+pt	NA	Perm	pm+pt	NA	Perm	pm+pt	NA	Perm	pm+pt	NA	Perm
Protected Phases	5	2		1	6		3	8		7	4	
Permitted Phases	2		2	6		6	8		8	4		4
Detector Phase	5	2	2	1	6	6	3	8	8	7	4	4
Switch Phase												
Minimum Initial (s)	5.0	5.0	5.0	5.0	5.0	5.0	5.0	5.0	5.0	5.0	5.0	5.0
Minimum Split (s)	12.5	25.0	25.0	12.5	25.0	25.0	13.5	25.0	25.0	13.5	25.0	25.0
Total Split (s)	14.0	37.0	37.0	14.0	37.0	37.0	14.0	25.0	25.0	14.0	25.0	25.0
Total Split (%)	15.6%	41.1%	41.1%	15.6%	41.1%	41.1%	15.6%	27.8%	27.8%	15.6%	27.8%	27.8%
Yellow Time (s)	4.0	5.0	5.0	4.0	5.0	5.0	5.0	5.0	5.0	5.0	5.0	5.0
All-Red Time (s)	3.5	2.0	2.0	3.5	2.0	2.0	3.5	2.0	2.0	3.5	2.0	2.0
Lost Time Adjust (s)	0.0	0.0	0.0	0.0	0.0	0.0	0.0	0.0	0.0	0.0	0.0	0.0
Total Lost Time (s)	7.5	7.0	7.0	7.5	7.0	7.0	8.5	7.0	7.0	8.5	7.0	7.0
Lead/Lag	Lead	Lag	Lag	Lead	Lag	Lag	Lead	Lag	Lag	Lead	Lag	Lag
Lead-Lag Optimize?	Yes	Yes	Yes	Yes	Yes	Yes	Yes	Yes	Yes	Yes	Yes	Yes
Recall Mode	None	C-Max	C-Max	None	C-Max	C-Max	None	Max	Max	None	Max	Max
Act Effct Green (s)	39.0	35.6	35.6	35.7	30.0	30.0	22.0	18.0	18.0	23.7	20.8	20.8
Actuated g/C Ratio	0.43	0.40	0.40	0.40	0.33	0.33	0.24	0.20	0.20	0.26	0.23	0.23
v/c Ratio	0.81	0.32	0.13	0.11	0.43	0.40	0.26	0.46	0.18	0.62	0.27	0.36
Control Delay	53.9	38.9	7.7	13.4	24.8	4.6	23.6	36.3	0.8	35.1	32.3	4.2
Queue Delay	0.0	0.0	0.0	0.0	0.0	0.0	0.0	0.0	0.0	0.0	0.0	0.0
Total Delay	53.9	38.9	7.7	13.4	24.8	4.6	23.6	36.3	0.8	35.1	32.3	4.2
LOS	D	D	A	B	C	A	C	D	A	D	C	A
Approach Delay		40.6			17.2			23.9			22.7	
Approach LOS		D			B			C			C	

Intersection Summary

Cycle Length: 90
 Actuated Cycle Length: 90
 Offset: 0 (0%), Referenced to phase 2:EBTL and 6:WBTL, Start of Green
 Natural Cycle: 80
 Control Type: Actuated-Coordinated
 Maximum v/c Ratio: 0.81
 Intersection Signal Delay: 27.0
 Intersection LOS: C
 Intersection Capacity Utilization 73.3%
 ICU Level of Service D
 Analysis Period (min) 15

Splits and Phases: 8: McLaughlin Rd & Woodmen Rd

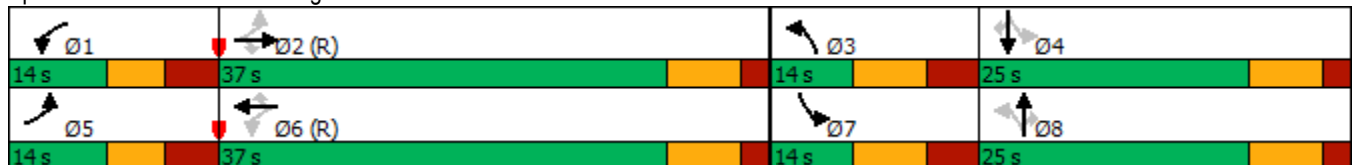

Timings
9: US 24 & Woodmen Rd

2028 Total Traffic
PM Peak Hour

Lane Group	EBL	EBT	EBR	WBL	WBT	WBR	NBL	NBT	NBR	SBL	SBT	SBR
Lane Configurations												
Traffic Volume (vph)	419	191	117	52	181	78	332	479	109	43	323	308
Future Volume (vph)	419	191	117	52	181	78	332	479	109	43	323	308
Turn Type	pm+pt	NA	Perm	pm+pt	NA	Free	pm+pt	NA	Free	pm+pt	NA	Free
Protected Phases	7	4		3	8		5	2		1	6	
Permitted Phases	4		4	8		Free	2		Free	6		Free
Detector Phase	7	4	4	3	8		5	2		1	6	
Switch Phase												
Minimum Initial (s)	5.0	15.0	15.0	5.0	15.0		5.0	15.0		5.0	15.0	
Minimum Split (s)	10.0	23.0	23.0	10.0	23.0		10.0	23.0		10.0	23.0	
Total Split (s)	30.0	45.0	45.0	10.0	25.0		15.0	55.0		10.0	50.0	
Total Split (%)	25.0%	37.5%	37.5%	8.3%	20.8%		12.5%	45.8%		8.3%	41.7%	
Yellow Time (s)	3.0	3.0	3.0	3.0	3.0		3.0	3.0		3.0	3.0	
All-Red Time (s)	2.0	2.0	2.0	2.0	2.0		2.0	2.0		2.0	2.0	
Lost Time Adjust (s)	0.0	0.0	0.0	0.0	0.0		0.0	0.0		0.0	0.0	
Total Lost Time (s)	5.0	5.0	5.0	5.0	5.0		5.0	5.0		5.0	5.0	
Lead/Lag	Lead	Lag	Lag	Lead	Lag		Lead	Lag		Lead	Lag	
Lead-Lag Optimize?	Yes	Yes	Yes	Yes	Yes		Yes	Yes		Yes	Yes	
Recall Mode	None	None	None	None	None		None	C-Max		None	C-Max	
Act Effct Green (s)	45.1	37.1	37.1	20.1	15.1	120.0	64.9	55.0	120.0	54.5	47.5	120.0
Actuated g/C Ratio	0.38	0.31	0.31	0.17	0.13	1.00	0.54	0.46	1.00	0.45	0.40	1.00
v/c Ratio	0.86	0.36	0.21	0.26	0.44	0.05	0.44	0.66	0.07	0.16	0.51	0.23
Control Delay	49.9	35.4	6.5	30.1	52.1	0.1	16.0	30.9	0.1	14.9	30.9	0.3
Queue Delay	0.0	0.0	0.0	0.0	0.0	0.0	0.0	0.0	0.0	0.0	0.0	0.0
Total Delay	49.9	35.4	6.5	30.1	52.1	0.1	16.0	30.9	0.1	14.9	30.9	0.3
LOS	D	D	A	C	D	A	B	C	A	B	C	A
Approach Delay		39.0			35.3			22.1			15.9	
Approach LOS		D			D			C			B	

Intersection Summary

Cycle Length: 120
 Actuated Cycle Length: 120
 Offset: 63 (53%), Referenced to phase 2:NBTL and 6:SBTL, Start of Green
 Natural Cycle: 80
 Control Type: Actuated-Coordinated
 Maximum v/c Ratio: 0.86
 Intersection Signal Delay: 26.4
 Intersection LOS: C
 Intersection Capacity Utilization 81.8%
 ICU Level of Service D
 Analysis Period (min) 15

Splits and Phases: 9: US 24 & Woodmen Rd

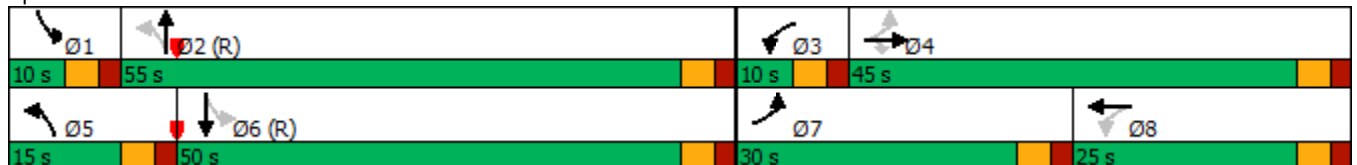

Timings
10: US 24 & Meridian Rd

2028 Total Traffic
PM Peak Hour

Lane Group	EBL	EBT	EBR	WBL	WBT	WBR	NBL	NBT	NBR	SBL	SBT	SBR
Lane Configurations												
Traffic Volume (vph)	19	256	294	32	369	53	587	800	12	92	440	7
Future Volume (vph)	19	256	294	32	369	53	587	800	12	92	440	7
Turn Type	pm+pt	NA	Free	pm+pt	NA	Free	Prot	NA	Perm	pm+pt	NA	Perm
Protected Phases	5	2		1	6		3	8		7	4	
Permitted Phases	2		Free	6		Free			8	4		4
Detector Phase	5	2		1	6		3	8	8	7	4	4
Switch Phase												
Minimum Initial (s)	5.0	5.0		5.0	5.0		5.0	5.0	5.0	5.0	5.0	5.0
Minimum Split (s)	11.0	20.0		11.0	20.0		11.0	20.0	20.0	11.0	20.0	20.0
Total Split (s)	11.0	20.0		11.0	20.0		25.0	47.0	47.0	12.0	34.0	34.0
Total Split (%)	12.2%	22.2%		12.2%	22.2%		27.8%	52.2%	52.2%	13.3%	37.8%	37.8%
Yellow Time (s)	3.0	5.0		3.0	5.0		3.0	4.5	4.5	3.0	4.5	4.5
All-Red Time (s)	3.0	2.0		3.0	2.0		3.0	2.0	2.0	3.0	2.0	2.0
Lost Time Adjust (s)	0.0	0.0		0.0	0.0		0.0	0.0	0.0	0.0	0.0	0.0
Total Lost Time (s)	6.0	7.0		6.0	7.0		6.0	6.5	6.5	6.0	6.5	6.5
Lead/Lag	Lead	Lag		Lead	Lag		Lead	Lag	Lag	Lead	Lag	Lag
Lead-Lag Optimize?	Yes	Yes		Yes	Yes		Yes	Yes	Yes	Yes	Yes	Yes
Recall Mode	None	C-Max		None	C-Max		None	None	None	None	None	None
Act Effct Green (s)	22.5	18.5	90.0	23.7	20.7	90.0	18.6	41.8	41.8	33.3	26.8	26.8
Actuated g/C Ratio	0.25	0.21	1.00	0.26	0.23	1.00	0.21	0.46	0.46	0.37	0.30	0.30
v/c Ratio	0.07	0.37	0.20	0.11	0.48	0.04	0.88	0.98	0.02	0.49	0.84	0.01
Control Delay	25.8	32.5	0.3	25.1	34.6	0.0	50.2	53.2	0.0	22.0	45.1	0.0
Queue Delay	0.0	0.0	0.0	0.0	0.0	0.0	0.0	0.0	0.0	0.0	0.0	0.0
Total Delay	25.8	32.5	0.3	25.1	34.6	0.0	50.2	53.2	0.0	22.0	45.1	0.0
LOS	C	C	A	C	C	A	D	D	A	C	D	A
Approach Delay		15.6			29.9			51.5			40.6	
Approach LOS		B			C			D			D	

Intersection Summary

Cycle Length: 90
 Actuated Cycle Length: 90
 Offset: 71 (79%), Referenced to phase 2:EBTL and 6:WBTL, Start of FDW or yellow
 Natural Cycle: 90
 Control Type: Actuated-Coordinated
 Maximum v/c Ratio: 0.98
 Intersection Signal Delay: 39.3
 Intersection LOS: D
 Intersection Capacity Utilization 82.8%
 ICU Level of Service E
 Analysis Period (min) 15

Splits and Phases: 10: US 24 & Meridian Rd

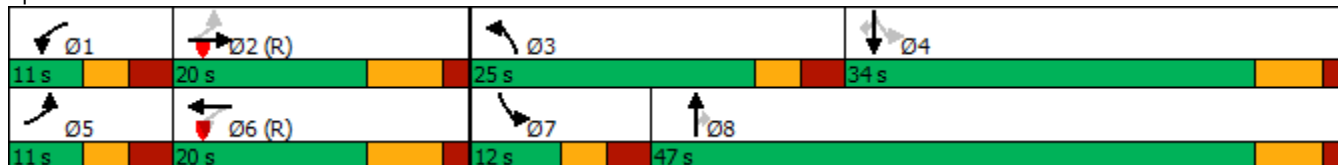

Intersection												
Int Delay, s/veh	0											
Movement	EBL	EBT	EBR	WBL	WBT	WBR	NBL	NBT	NBR	SBL	SBT	SBR
Lane Configurations			↗			↗		↖	↗		↖	↗
Traffic Vol, veh/h	0	0	52	0	0	73	0	847	25	0	487	5
Future Vol, veh/h	0	0	52	0	0	73	0	847	25	0	487	5
Conflicting Peds, #/hr	0	0	0	0	0	0	0	0	0	0	0	0
Sign Control	Stop	Stop	Stop	Stop	Stop	Stop	Free	Free	Free	Free	Free	Free
RT Channelized	-	-	Free	-	-	Free	-	-	None	-	-	None
Storage Length	-	-	0	-	-	0	-	-	400	-	-	400
Veh in Median Storage, #	-	0	-	-	0	-	-	0	-	-	0	-
Grade, %	-	0	-	-	0	-	-	0	-	-	0	-
Peak Hour Factor	90	90	90	90	90	90	90	90	90	90	90	90
Heavy Vehicles, %	2	2	2	2	2	2	2	2	2	2	2	2
Mvmt Flow	0	0	58	0	0	81	0	941	28	0	541	6

Major/Minor	Minor2		Minor1			Major1			Major2			
Conflicting Flow All	-	-	-	-	-	-	-	0	0	-	-	0
Stage 1	-	-	-	-	-	-	-	-	-	-	-	-
Stage 2	-	-	-	-	-	-	-	-	-	-	-	-
Critical Hdwy	-	-	-	-	-	-	-	-	-	-	-	-
Critical Hdwy Stg 1	-	-	-	-	-	-	-	-	-	-	-	-
Critical Hdwy Stg 2	-	-	-	-	-	-	-	-	-	-	-	-
Follow-up Hdwy	-	-	-	-	-	-	-	-	-	-	-	-
Pot Cap-1 Maneuver	0	0	0	0	0	0	0	-	-	0	-	-
Stage 1	0	0	0	0	0	0	0	-	-	0	-	-
Stage 2	0	0	0	0	0	0	0	-	-	0	-	-
Platoon blocked, %	-	-	-	-	-	-	-	-	-	-	-	-
Mov Cap-1 Maneuver	-	-	-	-	-	-	-	-	-	-	-	-
Mov Cap-2 Maneuver	-	-	-	-	-	-	-	-	-	-	-	-
Stage 1	-	-	-	-	-	-	-	-	-	-	-	-
Stage 2	-	-	-	-	-	-	-	-	-	-	-	-

Approach	EB		WB			NB			SB		
HCM Control Delay, s	0		0			0			0		
HCM LOS	A		A								

Minor Lane/Major Mvmt	NBT	NBR	EBLn1WBLn1	SBT	SBR
Capacity (veh/h)	-	-	-	-	-
HCM Lane V/C Ratio	-	-	-	-	-
HCM Control Delay (s)	-	-	0	0	-
HCM Lane LOS	-	-	A	A	-
HCM 95th %tile Q(veh)	-	-	-	-	-

Intersection						
Int Delay, s/veh	0.9					
Movement	EBL	EBR	NBL	NBT	SBT	SBR
Lane Configurations	↔			↑	↑	
Traffic Vol, veh/h	10	8	6	116	97	6
Future Vol, veh/h	10	8	6	116	97	6
Conflicting Peds, #/hr	0	0	0	0	0	0
Sign Control	Stop	Stop	Free	Free	Free	Free
RT Channelized	-	None	-	None	-	None
Storage Length	0	-	-	-	-	-
Veh in Median Storage, #	0	-	-	0	0	-
Grade, %	0	-	-	0	0	-
Peak Hour Factor	92	92	92	92	92	92
Heavy Vehicles, %	2	2	2	2	2	2
Mvmt Flow	11	9	7	126	105	7

Major/Minor	Minor2	Major1		Major2	
Conflicting Flow All	249	109	112	0	0
Stage 1	109	-	-	-	-
Stage 2	140	-	-	-	-
Critical Hdwy	6.42	6.22	4.12	-	-
Critical Hdwy Stg 1	5.42	-	-	-	-
Critical Hdwy Stg 2	5.42	-	-	-	-
Follow-up Hdwy	3.518	3.318	2.218	-	-
Pot Cap-1 Maneuver	739	945	1478	-	-
Stage 1	916	-	-	-	-
Stage 2	887	-	-	-	-
Platoon blocked, %				-	-
Mov Cap-1 Maneuver	735	945	1478	-	-
Mov Cap-2 Maneuver	735	-	-	-	-
Stage 1	911	-	-	-	-
Stage 2	887	-	-	-	-

Approach	EB	NB	SB
HCM Control Delay, s	9.5	0.4	0
HCM LOS	A		

Minor Lane/Major Mvmt	NBL	NBT	EBLn1	SBT	SBR
Capacity (veh/h)	1478	-	816	-	-
HCM Lane V/C Ratio	0.004	-	0.024	-	-
HCM Control Delay (s)	7.4	-	9.5	-	-
HCM Lane LOS	A	-	A	-	-
HCM 95th %tile Q(veh)	0	-	0.1	-	-

Timings
7: Meridian Rd & Woodmen Rd

2044 Background Traffic
AM Peak Hour

Lane Group	EBL	EBT	EBR	WBL	WBT	WBR	NBL	NBT	NBR	SBL	SBT	SBR
Lane Configurations												
Traffic Volume (vph)	472	470	176	148	808	155	326	347	97	270	950	1041
Future Volume (vph)	472	470	176	148	808	155	326	347	97	270	950	1041
Turn Type	Prot	NA	Free	Prot	NA	Perm	Prot	NA	Free	Prot	NA	Free
Protected Phases	7	4		3	8		5	2		1	6	
Permitted Phases			Free			8			Free			Free
Detector Phase	7	4		3	8	8	5	2		1	6	
Switch Phase												
Minimum Initial (s)	5.0	15.0		5.0	15.0	15.0	5.0	15.0		5.0	15.0	
Minimum Split (s)	12.5	22.0		12.5	22.0	22.0	13.5	22.0		13.5	22.0	
Total Split (s)	21.0	41.0		19.0	39.0	39.0	20.0	34.0		26.0	40.0	
Total Split (%)	17.5%	34.2%		15.8%	32.5%	32.5%	16.7%	28.3%		21.7%	33.3%	
Yellow Time (s)	3.0	3.0		3.0	3.0	3.0	3.0	3.0		3.0	3.0	
All-Red Time (s)	2.0	2.0		2.0	2.0	2.0	2.0	2.0		2.0	2.0	
Lost Time Adjust (s)	0.0	0.0		0.0	0.0	0.0	0.0	0.0		0.0	0.0	
Total Lost Time (s)	5.0	5.0		5.0	5.0	5.0	5.0	5.0		5.0	5.0	
Lead/Lag	Lead	Lag		Lead	Lag	Lag	Lead	Lag		Lead	Lag	
Lead-Lag Optimize?	Yes	Yes		Yes	Yes	Yes	Yes	Yes		Yes	Yes	
Recall Mode	None	None		None	None	None	None	C-Max		None	C-Max	
Act Effct Green (s)	16.0	37.8	120.0	10.7	32.5	32.5	14.7	36.4	120.0	15.1	36.8	120.0
Actuated g/C Ratio	0.13	0.32	1.00	0.09	0.27	0.27	0.12	0.30	1.00	0.13	0.31	1.00
v/c Ratio	1.08	0.44	0.12	0.50	0.88	0.29	0.81	0.34	0.06	0.65	0.91	0.68
Control Delay	113.1	34.2	0.1	57.5	53.2	6.4	66.8	34.6	0.1	57.1	54.0	2.4
Queue Delay	0.0	0.0	0.0	0.0	0.0	0.0	0.0	0.0	0.0	0.0	0.0	0.0
Total Delay	113.1	34.2	0.1	57.5	53.2	6.4	66.8	34.6	0.1	57.1	54.0	2.4
LOS	F	C	A	E	D	A	E	C	A	E	D	A
Approach Delay		62.2			47.3			43.9			30.6	
Approach LOS		E			D			D			C	

Intersection Summary

Cycle Length: 120
 Actuated Cycle Length: 120
 Offset: 0 (0%), Referenced to phase 2:NBT and 6:SBT, Start of FDW or yellow, Master Intersection
 Natural Cycle: 90
 Control Type: Actuated-Coordinated
 Maximum v/c Ratio: 1.08
 Intersection Signal Delay: 42.8
 Intersection LOS: D
 Intersection Capacity Utilization 88.0%
 ICU Level of Service E
 Analysis Period (min) 15

Splits and Phases: 7: Meridian Rd & Woodmen Rd

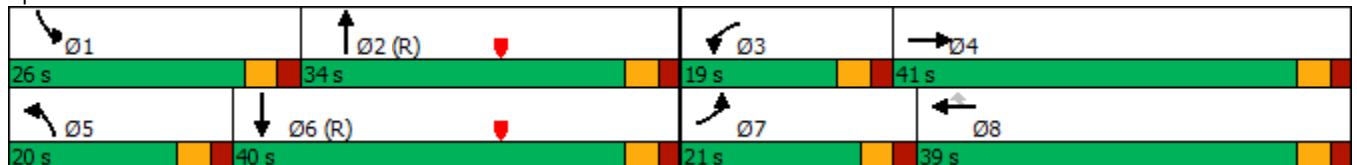

Timings
9: US 24 & Woodmen Rd

2044 Background Traffic
AM Peak Hour

Lane Group	EBL	EBT	EBR	WBL	WBT	WBR	NBL	NBT	NBR	SBL	SBT	SBR
Lane Configurations												
Traffic Volume (vph)	375	87	350	21	51	33	400	750	17	44	925	485
Future Volume (vph)	375	87	350	21	51	33	400	750	17	44	925	485
Turn Type	Prot	NA	Free	pm+pt	NA	Free	Prot	NA	Perm	pm+pt	NA	Free
Protected Phases	7	4		3	8		5	2		1	6	
Permitted Phases			Free	8		Free			2	6		Free
Detector Phase	7	4		3	8		5	2	2	1	6	
Switch Phase												
Minimum Initial (s)	20.0	15.0		5.0	15.0		5.0	15.0	15.0	5.0	15.0	
Minimum Split (s)	25.0	23.0		10.0	23.0		10.0	23.0	23.0	10.0	23.0	
Total Split (s)	27.0	37.0		15.0	25.0		20.0	58.0	58.0	10.0	48.0	
Total Split (%)	22.5%	30.8%		12.5%	20.8%		16.7%	48.3%	48.3%	8.3%	40.0%	
Yellow Time (s)	3.0	3.0		3.0	3.0		3.0	3.0	3.0	3.0	3.0	
All-Red Time (s)	2.0	2.0		2.0	2.0		2.0	2.0	2.0	2.0	2.0	
Lost Time Adjust (s)	0.0	0.0		0.0	0.0		0.0	0.0	0.0	0.0	0.0	
Total Lost Time (s)	5.0	5.0		5.0	5.0		5.0	5.0	5.0	5.0	5.0	
Lead/Lag	Lead	Lag		Lead	Lag		Lead	Lag	Lag	Lead	Lag	
Lead-Lag Optimize?	Yes	Yes		Yes	Yes		Yes	Yes	Yes	Yes	Yes	
Recall Mode	None	None		None	None		None	C-Max	C-Max	None	C-Max	
Act Effct Green (s)	20.6	29.3	120.0	18.6	15.0	120.0	21.0	63.5	63.5	54.3	47.4	120.0
Actuated g/C Ratio	0.17	0.24	1.00	0.16	0.12	1.00	0.18	0.53	0.53	0.45	0.40	1.00
v/c Ratio	0.68	0.21	0.24	0.10	0.12	0.02	0.72	0.30	0.02	0.14	0.50	0.33
Control Delay	53.1	37.2	0.4	28.9	47.5	0.0	54.4	18.0	0.1	13.8	29.6	0.6
Queue Delay	0.0	0.0	0.0	0.0	0.0	0.0	0.0	0.0	0.0	0.0	0.0	0.0
Total Delay	53.1	37.2	0.4	28.9	47.5	0.0	54.4	18.0	0.1	13.8	29.6	0.6
LOS	D	D	A	C	D	A	D	B	A	B	C	A
Approach Delay		28.7			28.8			30.3			19.4	
Approach LOS		C			C			C			B	

Intersection Summary

Cycle Length: 120
 Actuated Cycle Length: 120
 Offset: 118 (98%), Referenced to phase 2:NBT and 6:SBTL, Start of Green
 Natural Cycle: 85
 Control Type: Actuated-Coordinated
 Maximum v/c Ratio: 0.72
 Intersection Signal Delay: 25.4
 Intersection LOS: C
 Intersection Capacity Utilization 59.1%
 ICU Level of Service B
 Analysis Period (min) 15

Splits and Phases: 9: US 24 & Woodmen Rd

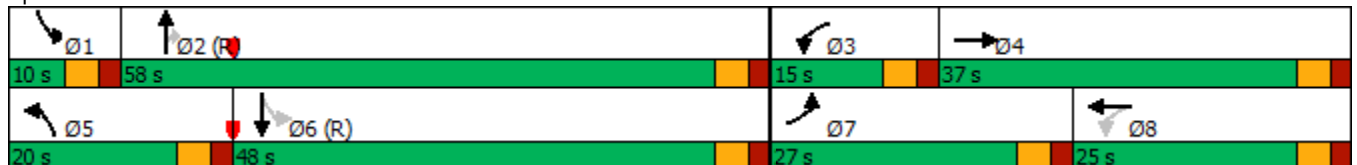

Intersection												
Int Delay, s/veh	0											
Movement	EBL	EBT	EBR	WBL	WBT	WBR	NBL	NBT	NBR	SBL	SBT	SBR
Lane Configurations			↗			↗		↗↗↗	↗		↗↗↗	↗
Traffic Vol, veh/h	0	0	50	0	0	130	0	1037	130	0	1261	35
Future Vol, veh/h	0	0	50	0	0	130	0	1037	130	0	1261	35
Conflicting Peds, #/hr	0	0	0	0	0	0	0	0	0	0	0	0
Sign Control	Stop	Stop	Stop	Stop	Stop	Stop	Free	Free	Free	Free	Free	Free
RT Channelized	-	-	Free	-	-	Free	-	-	None	-	-	None
Storage Length	-	-	0	-	-	0	-	-	-	-	-	-
Veh in Median Storage, #	-	0	-	-	0	-	-	0	-	-	0	-
Grade, %	-	0	-	-	0	-	-	0	-	-	0	-
Peak Hour Factor	91	91	91	91	91	91	91	91	91	91	91	91
Heavy Vehicles, %	2	2	2	2	2	2	2	2	2	2	2	2
Mvmt Flow	0	0	55	0	0	143	0	1140	143	0	1386	38

Major/Minor	Minor2		Minor1			Major1			Major2			
Conflicting Flow All	-	-	-	-	-	-	-	0	0	-	-	0
Stage 1	-	-	-	-	-	-	-	-	-	-	-	-
Stage 2	-	-	-	-	-	-	-	-	-	-	-	-
Critical Hdwy	-	-	-	-	-	-	-	-	-	-	-	-
Critical Hdwy Stg 1	-	-	-	-	-	-	-	-	-	-	-	-
Critical Hdwy Stg 2	-	-	-	-	-	-	-	-	-	-	-	-
Follow-up Hdwy	-	-	-	-	-	-	-	-	-	-	-	-
Pot Cap-1 Maneuver	0	0	0	0	0	0	0	-	-	0	-	-
Stage 1	0	0	0	0	0	0	0	-	-	0	-	-
Stage 2	0	0	0	0	0	0	0	-	-	0	-	-
Platoon blocked, %	-	-	-	-	-	-	-	-	-	-	-	-
Mov Cap-1 Maneuver	-	-	-	-	-	-	-	-	-	-	-	-
Mov Cap-2 Maneuver	-	-	-	-	-	-	-	-	-	-	-	-
Stage 1	-	-	-	-	-	-	-	-	-	-	-	-
Stage 2	-	-	-	-	-	-	-	-	-	-	-	-

Approach	EB	WB	NB	SB
HCM Control Delay, s	0	0	0	0
HCM LOS	A	A		

Minor Lane/Major Mvmt	NBT	NBR	EBLn1WBLn1	SBT	SBR
Capacity (veh/h)	-	-	-	-	-
HCM Lane V/C Ratio	-	-	-	-	-
HCM Control Delay (s)	-	-	0	0	-
HCM Lane LOS	-	-	A	A	-
HCM 95th %tile Q(veh)	-	-	-	-	-

Timings
7: Meridian Rd & Woodmen Rd

2044 Background Traffic
PM Peak Hour

Lane Group	EBL	EBT	EBR	WBL	WBT	WBR	NBL	NBT	NBR	SBL	SBT	SBR
Lane Configurations												
Traffic Volume (vph)	785	659	376	223	595	249	463	896	197	459	713	602
Future Volume (vph)	785	659	376	223	595	249	463	896	197	459	713	602
Turn Type	Prot	NA	Free	Prot	NA	Perm	Prot	NA	Free	Prot	NA	Free
Protected Phases	7	4		3	8		5	2		1	6	
Permitted Phases			Free			8			Free			Free
Detector Phase	7	4		3	8	8	5	2		1	6	
Switch Phase												
Minimum Initial (s)	5.0	15.0		5.0	15.0	15.0	5.0	15.0		5.0	15.0	
Minimum Split (s)	12.5	22.0		12.5	22.0	22.0	13.5	22.0		13.5	22.0	
Total Split (s)	32.0	43.0		18.0	29.0	29.0	23.0	36.0		23.0	36.0	
Total Split (%)	26.7%	35.8%		15.0%	24.2%	24.2%	19.2%	30.0%		19.2%	30.0%	
Yellow Time (s)	3.0	3.0		3.0	3.0	3.0	3.0	3.0		3.0	3.0	
All-Red Time (s)	2.0	2.0		2.0	2.0	2.0	2.0	2.0		2.0	2.0	
Lost Time Adjust (s)	0.0	0.0		0.0	0.0	0.0	0.0	0.0		0.0	0.0	
Total Lost Time (s)	5.0	5.0		5.0	5.0	5.0	5.0	5.0		5.0	5.0	
Lead/Lag	Lead	Lag		Lead	Lag	Lag	Lead	Lag		Lead	Lag	
Lead-Lag Optimize?	Yes	Yes		Yes	Yes	Yes	Yes	Yes		Yes	Yes	
Recall Mode	None	None		None	None	None	None	C-Max		None	C-Max	
Act Effct Green (s)	27.0	38.5	120.0	12.1	23.6	23.6	18.1	31.3	120.0	18.1	31.3	120.0
Actuated g/C Ratio	0.22	0.32	1.00	0.10	0.20	0.20	0.15	0.26	1.00	0.15	0.26	1.00
v/c Ratio	1.06	0.60	0.25	0.67	0.89	0.50	0.93	1.01	0.13	0.93	0.81	0.40
Control Delay	94.0	37.2	0.4	78.1	51.7	11.8	76.2	76.3	0.2	75.5	49.5	0.7
Queue Delay	0.0	0.0	0.0	0.0	0.0	0.0	0.0	0.0	0.0	0.0	0.0	0.0
Total Delay	94.0	37.2	0.4	78.1	51.7	11.8	76.2	76.3	0.2	75.5	49.5	0.7
LOS	F	D	A	E	D	B	E	E	A	E	D	A
Approach Delay		54.1			47.9			66.7			39.7	
Approach LOS		D			D			E			D	

Intersection Summary

Cycle Length: 120
 Actuated Cycle Length: 120
 Offset: 0 (0%), Referenced to phase 2:NBT and 6:SBT, Start of FDW or yellow, Master Intersection
 Natural Cycle: 110
 Control Type: Actuated-Coordinated
 Maximum v/c Ratio: 1.06
 Intersection Signal Delay: 52.1
 Intersection LOS: D
 Intersection Capacity Utilization 93.4%
 ICU Level of Service F
 Analysis Period (min) 15

Splits and Phases: 7: Meridian Rd & Woodmen Rd

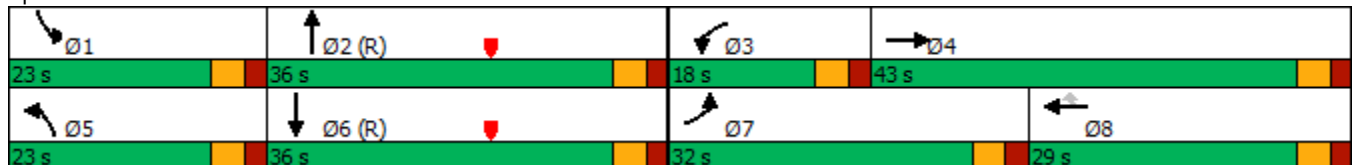

Timings
8: McLaughlin Rd & Woodmen Rd

2044 Background Traffic
PM Peak Hour

Lane Group	EBL	EBT	EBR	WBL	WBT	WBR	NBL	NBT	NBR	SBL	SBT	SBR
Lane Configurations												
Traffic Volume (vph)	300	865	150	100	717	275	150	200	150	200	150	200
Future Volume (vph)	300	865	150	100	717	275	150	200	150	200	150	200
Turn Type	pm+pt	NA	Perm	pm+pt	NA	Perm	pm+pt	NA	Perm	pm+pt	NA	Perm
Protected Phases	5	2		1	6		3	8		7	4	
Permitted Phases	2		2	6		6	8		8	4		4
Detector Phase	5	2	2	1	6	6	3	8	8	7	4	4
Switch Phase												
Minimum Initial (s)	5.0	5.0	5.0	5.0	5.0	5.0	5.0	5.0	5.0	5.0	5.0	5.0
Minimum Split (s)	12.5	25.0	25.0	12.5	25.0	25.0	13.5	25.0	25.0	13.5	25.0	25.0
Total Split (s)	24.0	57.0	57.0	15.0	48.0	48.0	15.0	29.0	29.0	19.0	33.0	33.0
Total Split (%)	20.0%	47.5%	47.5%	12.5%	40.0%	40.0%	12.5%	24.2%	24.2%	15.8%	27.5%	27.5%
Yellow Time (s)	4.0	5.0	5.0	4.0	5.0	5.0	5.0	5.0	5.0	5.0	5.0	5.0
All-Red Time (s)	3.5	2.0	2.0	3.5	2.0	2.0	3.5	2.0	2.0	3.5	2.0	2.0
Lost Time Adjust (s)	0.0	0.0	0.0	0.0	0.0	0.0	0.0	0.0	0.0	0.0	0.0	0.0
Total Lost Time (s)	7.5	7.0	7.0	7.5	7.0	7.0	8.5	7.0	7.0	8.5	7.0	7.0
Lead/Lag	Lead	Lag	Lag	Lead	Lag	Lag	Lead	Lag	Lag	Lead	Lag	Lag
Lead-Lag Optimize?	Yes	Yes	Yes	Yes	Yes	Yes	Yes	Yes	Yes	Yes	Yes	Yes
Recall Mode	None	C-Max	C-Max	None	C-Max	C-Max	None	Max	Max	None	Max	Max
Act Effct Green (s)	64.2	50.2	50.2	48.7	41.9	41.9	27.0	22.0	22.0	35.0	26.0	26.0
Actuated g/C Ratio	0.54	0.42	0.42	0.41	0.35	0.35	0.22	0.18	0.18	0.29	0.22	0.22
v/c Ratio	0.80	0.60	0.20	0.39	0.60	0.39	0.51	0.60	0.31	0.68	0.38	0.38
Control Delay	49.9	49.9	15.8	16.1	28.7	7.2	39.7	53.4	1.7	44.0	43.5	4.2
Queue Delay	0.0	0.0	0.0	0.0	0.0	0.0	0.0	0.0	0.0	0.0	0.0	0.0
Total Delay	49.9	49.9	15.8	16.1	28.7	7.2	39.7	53.4	1.7	44.0	43.5	4.2
LOS	D	D	B	B	C	A	D	D	A	D	D	A
Approach Delay		46.0			22.1			33.7			29.4	
Approach LOS		D			C			C			C	

Intersection Summary

Cycle Length: 120
 Actuated Cycle Length: 120
 Offset: 118 (98%), Referenced to phase 2:EBTL and 6:WBTL, Start of Green
 Natural Cycle: 90
 Control Type: Actuated-Coordinated
 Maximum v/c Ratio: 0.80
 Intersection Signal Delay: 34.0
 Intersection LOS: C
 Intersection Capacity Utilization 81.8%
 ICU Level of Service D
 Analysis Period (min) 15

Splits and Phases: 8: McLaughlin Rd & Woodmen Rd

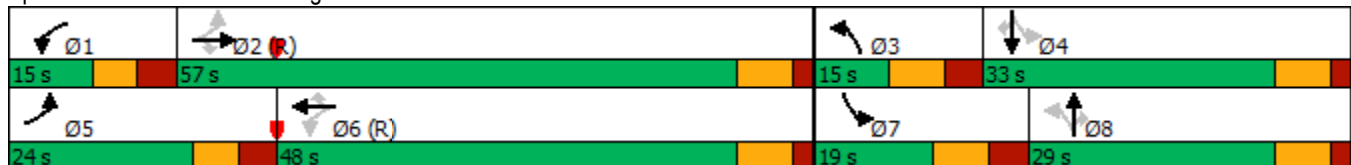

Timings
9: US 24 & Woodmen Rd

2044 Background Traffic
PM Peak Hour

Lane Group	EBL	EBT	EBR	WBL	WBT	WBR	NBL	NBT	NBR	SBL	SBT	SBR
Lane Configurations												
Traffic Volume (vph)	800	180	235	27	187	112	450	1600	67	66	1060	455
Future Volume (vph)	800	180	235	27	187	112	450	1600	67	66	1060	455
Turn Type	Prot	NA	Free	pm+pt	NA	Free	Prot	NA	Perm	pm+pt	NA	Free
Protected Phases	7	4		3	8		5	2		1	6	
Permitted Phases			Free	8		Free			2	6		Free
Detector Phase	7	4		3	8		5	2	2	1	6	
Switch Phase												
Minimum Initial (s)	5.0	15.0		5.0	15.0		12.0	15.0	15.0	5.0	10.0	
Minimum Split (s)	10.0	23.0		10.0	23.0		25.0	23.0	23.0	10.0	23.0	
Total Split (s)	34.0	47.0		10.0	23.0		31.0	53.0	53.0	10.0	32.0	
Total Split (%)	28.3%	39.2%		8.3%	19.2%		25.8%	44.2%	44.2%	8.3%	26.7%	
Yellow Time (s)	3.0	3.0		3.0	3.0		3.0	3.0	3.0	3.0	3.0	
All-Red Time (s)	2.0	2.0		2.0	2.0		2.0	2.0	2.0	2.0	2.0	
Lost Time Adjust (s)	0.0	0.0		0.0	0.0		0.0	0.0	0.0	0.0	0.0	
Total Lost Time (s)	5.0	5.0		5.0	5.0		5.0	5.0	5.0	5.0	5.0	
Lead/Lag	Lead	Lag		Lead	Lag		Lead	Lag	Lag	Lead	Lag	
Lead-Lag Optimize?	Yes	Yes		Yes	Yes		Yes	Yes	Yes	Yes	Yes	
Recall Mode	None	None		None	None		None	C-Max	C-Max	None	C-Max	
Act Effct Green (s)	29.0	43.1	120.0	20.1	15.1	120.0	23.5	50.8	50.8	39.7	32.4	120.0
Actuated g/C Ratio	0.24	0.36	1.00	0.17	0.13	1.00	0.20	0.42	0.42	0.33	0.27	1.00
v/c Ratio	1.00	0.29	0.15	0.13	0.46	0.08	0.79	0.87	0.10	0.41	0.90	0.33
Control Delay	66.5	23.6	0.2	26.3	52.3	0.1	54.7	38.1	0.3	27.1	52.4	0.6
Queue Delay	0.0	0.0	0.0	0.0	0.0	0.0	0.0	0.0	0.0	0.0	0.0	0.0
Total Delay	66.5	23.6	0.2	26.3	52.3	0.1	54.7	38.1	0.3	27.1	52.4	0.6
LOS	E	C	A	C	D	A	D	D	A	C	D	A
Approach Delay		47.2			32.2			40.5			36.4	
Approach LOS		D			C			D			D	

Intersection Summary

Cycle Length: 120
 Actuated Cycle Length: 120
 Offset: 0 (0%), Referenced to phase 2:NBT and 6:SBTL, Start of Green
 Natural Cycle: 105
 Control Type: Actuated-Coordinated
 Maximum v/c Ratio: 1.00
 Intersection Signal Delay: 40.2
 Intersection LOS: D
 Intersection Capacity Utilization 87.1%
 ICU Level of Service E
 Analysis Period (min) 15

Splits and Phases: 9: US 24 & Woodmen Rd

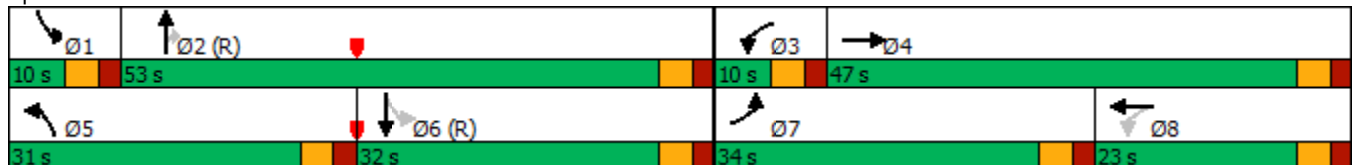

Intersection												
Int Delay, s/veh	0											
Movement	EBL	EBT	EBR	WBL	WBT	WBR	NBL	NBT	NBR	SBL	SBT	SBR
Lane Configurations			↗			↗		↑↑↑	↗		↑↑↑	↗
Traffic Vol, veh/h	0	0	75	0	0	175	0	1942	130	0	1307	15
Future Vol, veh/h	0	0	75	0	0	175	0	1942	130	0	1307	15
Conflicting Peds, #/hr	0	0	0	0	0	0	0	0	0	0	0	0
Sign Control	Stop	Stop	Stop	Stop	Stop	Stop	Free	Free	Free	Free	Free	Free
RT Channelized	-	-	Free	-	-	Free	-	-	None	-	-	None
Storage Length	-	-	0	-	-	0	-	-	-	-	-	-
Veh in Median Storage, #	-	0	-	-	0	-	-	0	-	-	0	-
Grade, %	-	0	-	-	0	-	-	0	-	-	0	-
Peak Hour Factor	90	90	90	90	90	90	90	90	90	90	90	90
Heavy Vehicles, %	2	2	2	2	2	2	2	2	2	2	2	2
Mvmt Flow	0	0	83	0	0	194	0	2158	144	0	1452	17

Major/Minor	Minor2		Minor1			Major1			Major2			
Conflicting Flow All	-	-	-	-	-	-	-	0	0	-	-	0
Stage 1	-	-	-	-	-	-	-	-	-	-	-	-
Stage 2	-	-	-	-	-	-	-	-	-	-	-	-
Critical Hdwy	-	-	-	-	-	-	-	-	-	-	-	-
Critical Hdwy Stg 1	-	-	-	-	-	-	-	-	-	-	-	-
Critical Hdwy Stg 2	-	-	-	-	-	-	-	-	-	-	-	-
Follow-up Hdwy	-	-	-	-	-	-	-	-	-	-	-	-
Pot Cap-1 Maneuver	0	0	0	0	0	0	0	-	-	0	-	-
Stage 1	0	0	0	0	0	0	0	-	-	0	-	-
Stage 2	0	0	0	0	0	0	0	-	-	0	-	-
Platoon blocked, %	-	-	-	-	-	-	-	-	-	-	-	-
Mov Cap-1 Maneuver	-	-	-	-	-	-	-	-	-	-	-	-
Mov Cap-2 Maneuver	-	-	-	-	-	-	-	-	-	-	-	-
Stage 1	-	-	-	-	-	-	-	-	-	-	-	-
Stage 2	-	-	-	-	-	-	-	-	-	-	-	-

Approach	EB		WB			NB			SB		
HCM Control Delay, s	0		0			0			0		
HCM LOS	A		A								

Minor Lane/Major Mvmt	NBT	NBR	EBLn1WBLn1	SBT	SBR
Capacity (veh/h)	-	-	-	-	-
HCM Lane V/C Ratio	-	-	-	-	-
HCM Control Delay (s)	-	-	0	0	-
HCM Lane LOS	-	-	A	A	-
HCM 95th %tile Q(veh)	-	-	-	-	-

Intersection												
Int Delay, s/veh	2.9											
Movement	EBL	EBT	EBR	WBL	WBT	WBR	NBL	NBT	NBR	SBL	SBT	SBR
Lane Configurations	↵	↵		↵	↵			↕			↕	
Traffic Vol, veh/h	0	68	0	16	110	11	0	0	49	22	0	0
Future Vol, veh/h	0	68	0	16	110	11	0	0	49	22	0	0
Conflicting Peds, #/hr	0	0	0	0	0	0	0	0	0	0	0	0
Sign Control	Free	Free	Free	Free	Free	Free	Stop	Stop	Stop	Stop	Stop	Stop
RT Channelized	-	-	None	-	-	None	-	-	None	-	-	None
Storage Length	135	-	-	190	-	-	-	-	-	-	-	-
Veh in Median Storage, #	-	0	-	-	0	-	-	0	-	-	0	-
Grade, %	-	0	-	-	0	-	-	0	-	-	0	-
Peak Hour Factor	92	92	92	92	92	92	92	92	92	92	92	92
Heavy Vehicles, %	2	2	2	2	2	2	2	2	2	2	2	2
Mvmt Flow	0	74	0	17	120	12	0	0	53	24	0	0

Major/Minor	Major1			Major2			Minor1			Minor2		
Conflicting Flow All	132	0	0	74	0	0	234	240	74	261	234	126
Stage 1	-	-	-	-	-	-	74	74	-	160	160	-
Stage 2	-	-	-	-	-	-	160	166	-	101	74	-
Critical Hdwy	4.12	-	-	4.12	-	-	7.12	6.52	6.22	7.12	6.52	6.22
Critical Hdwy Stg 1	-	-	-	-	-	-	6.12	5.52	-	6.12	5.52	-
Critical Hdwy Stg 2	-	-	-	-	-	-	6.12	5.52	-	6.12	5.52	-
Follow-up Hdwy	2.218	-	-	2.218	-	-	3.518	4.018	3.318	3.518	4.018	3.318
Pot Cap-1 Maneuver	1453	-	-	1526	-	-	721	661	988	692	666	924
Stage 1	-	-	-	-	-	-	935	833	-	842	766	-
Stage 2	-	-	-	-	-	-	842	761	-	905	833	-
Platoon blocked, %	-	-	-	-	-	-	-	-	-	-	-	-
Mov Cap-1 Maneuver	1453	-	-	1526	-	-	715	654	988	649	659	924
Mov Cap-2 Maneuver	-	-	-	-	-	-	715	654	-	649	659	-
Stage 1	-	-	-	-	-	-	935	833	-	842	758	-
Stage 2	-	-	-	-	-	-	833	753	-	856	833	-

Approach	EB			WB			NB			SB		
HCM Control Delay, s	0			0.9			8.9			10.8		
HCM LOS							A			B		

Minor Lane/Major Mvmt	NBLn1	EBL	EBT	EBR	WBL	WBT	WBR	SBLn1
Capacity (veh/h)	988	1453	-	-	1526	-	-	649
HCM Lane V/C Ratio	0.054	-	-	-	0.011	-	-	0.037
HCM Control Delay (s)	8.9	0	-	-	7.4	-	-	10.8
HCM Lane LOS	A	A	-	-	A	-	-	B
HCM 95th %tile Q(veh)	0.2	0	-	-	0	-	-	0.1

MOVEMENT FLOWS FOR SITE (INPUT)

Approach movement input flow rates (veh/h)

All Movement Classes

▼ Site: 2 [2043 Total AM - Single Southeastbound Approach (Site Folder: General)]

Woodmen/Retail Row

Site Category: 2043 Total AM
Roundabout

Use the button below to open or close all popup boxes. Click value labels to open selected ones.
Click and drag popup boxes to move to preferred positions.

Close All Popups

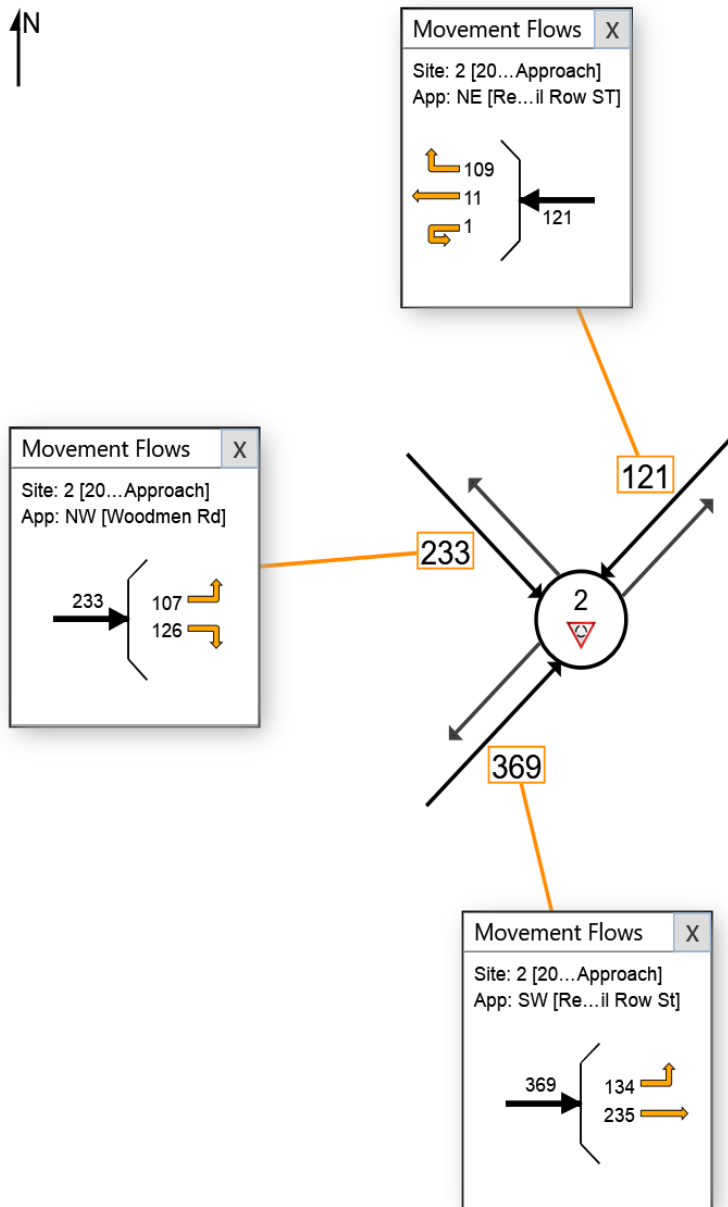

LANE SUMMARY

Site: 2 [2043 Total AM - Single Southeastbound Approach (Site Folder: General)]

Woodmen/Retail Row

Site Category: 2043 Total AM Roundabout

Lane Use and Performance													
	DEMAND FLOWS		Cap. veh/h	Deg. Satn v/c	Lane Util. %	Aver. Delay sec	Level of Service	95% BACK OF QUEUE		Lane Config	Lane Length ft	Cap. Adj. %	Prob. Block. %
	[Total veh/h	HV %						[Veh	Dist] ft				
NorthEast: Retail Row ST													
Lane 1 ^d	132	2.0	1163	0.113	100	4.1	LOS A	0.5	12.8	Full	1600	0.0	0.0
Approach	132	2.0		0.113		4.1	LOS A	0.5	12.8				
NorthWest: Woodmen Rd													
Lane 1 ^d	253	2.0	1335	0.190	100	4.3	LOS A	1.0	24.2	Full	1600	0.0	0.0
Approach	253	2.0		0.190		4.3	LOS A	1.0	24.2				
SouthWest: Retail Row St													
Lane 1 ^d	401	2.0	1197	0.335	100	6.2	LOS A	1.9	48.5	Full	1600	0.0	0.0
Approach	401	2.0		0.335		6.2	LOS A	1.9	48.5				
Intersection	786	2.0		0.335		5.2	LOS A	1.9	48.5				

Site Level of Service (LOS) Method: Delay & v/c (HCM 6). Site LOS Method is specified in the Parameter Settings dialog (Site tab). Roundabout LOS Method: Same as Sign Control.

Lane LOS values are based on average delay and v/c ratio (degree of saturation) per lane.

LOS F will result if v/c > 1 irrespective of lane delay value (does not apply for approaches and intersection).

Intersection and Approach LOS values are based on average delay for all lanes (v/c not used as specified in HCM 6).

Roundabout Capacity Model: US HCM 6.

Delay Model: HCM Delay Formula (Geometric Delay is not included).

Queue Model: HCM Queue Formula.

Gap-Acceptance Capacity: Traditional M1.

HV (%) values are calculated for All Movement Classes of All Heavy Vehicle Model Designation.

^d Dominant lane on roundabout approach

SIDRA INTERSECTION 9.0 | Copyright © 2000-2020 Akcelik and Associates Pty Ltd | sidrasolutions.com

Organisation: LSC TRANSPORTATION CONSULTANTS, INC. | Licence: PLUS / 1PC | Processed: Friday, October 6, 2023 10:09:44 AM

Project: G:\Shared drives\CS Engineering - 2019-current\2020\204120 - FalconField Prelim Plan\Sidra\2020-06-June\Woodmen & Retail Row St single sb approach.sip9

Intersection						
Int Delay, s/veh	2.6					
Movement	EBL	EBT	WBT	WBR	SBL	SBR
Lane Configurations	↙	↑	↗		↘	
Traffic Vol, veh/h	45	67	90	0	0	30
Future Vol, veh/h	45	67	90	0	0	30
Conflicting Peds, #/hr	0	0	0	0	0	0
Sign Control	Free	Free	Free	Free	Stop	Stop
RT Channelized	-	None	-	None	-	None
Storage Length	120	-	-	-	0	-
Veh in Median Storage, #	-	0	0	-	0	-
Grade, %	-	0	0	-	0	-
Peak Hour Factor	92	92	92	92	92	92
Heavy Vehicles, %	2	2	2	2	2	2
Mvmt Flow	49	73	98	0	0	33

Major/Minor	Major1	Major2	Minor2		
Conflicting Flow All	98	0	-	0	269 98
Stage 1	-	-	-	-	98 -
Stage 2	-	-	-	-	171 -
Critical Hdwy	4.12	-	-	-	6.42 6.22
Critical Hdwy Stg 1	-	-	-	-	5.42 -
Critical Hdwy Stg 2	-	-	-	-	5.42 -
Follow-up Hdwy	2.218	-	-	-	3.518 3.318
Pot Cap-1 Maneuver	1495	-	-	-	720 958
Stage 1	-	-	-	-	926 -
Stage 2	-	-	-	-	859 -
Platoon blocked, %		-	-	-	
Mov Cap-1 Maneuver	1495	-	-	-	696 958
Mov Cap-2 Maneuver	-	-	-	-	696 -
Stage 1	-	-	-	-	895 -
Stage 2	-	-	-	-	859 -

Approach	EB	WB	SB
HCM Control Delay, s	3	0	8.9
HCM LOS			A

Minor Lane/Major Mvmt	EBL	EBT	WBT	WBR	SBLn1
Capacity (veh/h)	1495	-	-	-	958
HCM Lane V/C Ratio	0.033	-	-	-	0.034
HCM Control Delay (s)	7.5	-	-	-	8.9
HCM Lane LOS	A	-	-	-	A
HCM 95th %tile Q(veh)	0.1	-	-	-	0.1

Intersection						
Int Delay, s/veh	1.8					
Movement	EBT	EBR	WBL	WBT	NBL	NBR
Lane Configurations						
Traffic Vol, veh/h	55	10	0	64	30	1
Future Vol, veh/h	55	10	0	64	30	1
Conflicting Peds, #/hr	0	0	0	0	0	0
Sign Control	Free	Free	Free	Free	Stop	Stop
RT Channelized	-	None	-	None	-	None
Storage Length	-	-	-	-	0	-
Veh in Median Storage, #	0	-	-	0	0	-
Grade, %	0	-	-	0	0	-
Peak Hour Factor	92	92	92	92	92	92
Heavy Vehicles, %	2	2	2	2	2	2
Mvmt Flow	60	11	0	70	33	1

Major/Minor	Major1	Major2	Minor1	Minor2	Minor3
Conflicting Flow All	0	0	71	0	136
Stage 1	-	-	-	-	66
Stage 2	-	-	-	-	70
Critical Hdwy	-	-	4.12	-	6.42
Critical Hdwy Stg 1	-	-	-	-	5.42
Critical Hdwy Stg 2	-	-	-	-	5.42
Follow-up Hdwy	-	-	2.218	-	3.518
Pot Cap-1 Maneuver	-	-	1529	-	857
Stage 1	-	-	-	-	957
Stage 2	-	-	-	-	953
Platoon blocked, %	-	-	-	-	-
Mov Cap-1 Maneuver	-	-	1529	-	857
Mov Cap-2 Maneuver	-	-	-	-	857
Stage 1	-	-	-	-	957
Stage 2	-	-	-	-	953

Approach	EB	WB	NB
HCM Control Delay, s	0	0	9.4
HCM LOS			A

Minor Lane/Major Mvmt	NBLn1	EBT	EBR	WBL	WBT
Capacity (veh/h)	861	-	-	1529	-
HCM Lane V/C Ratio	0.039	-	-	-	-
HCM Control Delay (s)	9.4	-	-	0	-
HCM Lane LOS	A	-	-	A	-
HCM 95th %tile Q(veh)	0.1	-	-	0	-

Intersection						
Int Delay, s/veh	0.7					
Movement	EBT	EBR	WBL	WBT	NBL	NBR
Lane Configurations						
Traffic Vol, veh/h	54	2	1	57	7	2
Future Vol, veh/h	54	2	1	57	7	2
Conflicting Peds, #/hr	0	0	0	0	0	0
Sign Control	Free	Free	Free	Free	Stop	Stop
RT Channelized	-	None	-	None	-	None
Storage Length	-	-	-	-	0	-
Veh in Median Storage, #	0	-	-	0	0	-
Grade, %	0	-	-	0	0	-
Peak Hour Factor	92	92	92	92	92	92
Heavy Vehicles, %	2	2	2	2	2	2
Mvmt Flow	59	2	1	62	8	2

Major/Minor	Major1	Major2	Minor1	Minor2	Minor3
Conflicting Flow All	0	0	61	0	124
Stage 1	-	-	-	-	60
Stage 2	-	-	-	-	64
Critical Hdwy	-	-	4.12	-	6.42
Critical Hdwy Stg 1	-	-	-	-	5.42
Critical Hdwy Stg 2	-	-	-	-	5.42
Follow-up Hdwy	-	-	2.218	-	3.518
Pot Cap-1 Maneuver	-	-	1542	-	871
Stage 1	-	-	-	-	963
Stage 2	-	-	-	-	959
Platoon blocked, %	-	-	-	-	-
Mov Cap-1 Maneuver	-	-	1542	-	870
Mov Cap-2 Maneuver	-	-	-	-	870
Stage 1	-	-	-	-	963
Stage 2	-	-	-	-	958

Approach	EB	WB	NB
HCM Control Delay, s	0	0.1	9.1
HCM LOS			A

Minor Lane/Major Mvmt	NBLn1	EBT	EBR	WBL	WBT
Capacity (veh/h)	897	-	-	1542	-
HCM Lane V/C Ratio	0.011	-	-	0.001	-
HCM Control Delay (s)	9.1	-	-	7.3	0
HCM Lane LOS	A	-	-	A	A
HCM 95th %tile Q(veh)	0	-	-	0	-

Timings
7: Meridian Rd & Woodmen Rd

2044 Total Traffic
AM Peak Hour

Lane Group	EBL	EBT	EBR	WBL	WBT	WBR	NBL	NBT	NBR	SBL	SBT	SBR
Lane Configurations												
Traffic Volume (vph)	472	486	175	150	846	168	328	344	100	294	941	1041
Future Volume (vph)	472	486	175	150	846	168	328	344	100	294	941	1041
Turn Type	Prot	NA	Free	Prot	NA	Perm	Prot	NA	Free	Prot	NA	Free
Protected Phases	7	4		3	8		5	2		1	6	
Permitted Phases			Free			8			Free			Free
Detector Phase	7	4		3	8	8	5	2		1	6	
Switch Phase												
Minimum Initial (s)	5.0	15.0		5.0	15.0	15.0	5.0	15.0		5.0	15.0	
Minimum Split (s)	12.5	22.0		12.5	22.0	22.0	13.5	22.0		13.5	22.0	
Total Split (s)	23.0	41.0		19.0	37.0	37.0	20.0	34.0		26.0	40.0	
Total Split (%)	19.2%	34.2%		15.8%	30.8%	30.8%	16.7%	28.3%		21.7%	33.3%	
Yellow Time (s)	4.0	5.0		4.0	5.0	5.0	5.0	5.0		5.0	5.0	
All-Red Time (s)	3.5	2.0		3.5	2.0	2.0	3.5	2.0		3.5	2.0	
Lost Time Adjust (s)	0.0	0.0		0.0	0.0	0.0	0.0	0.0		0.0	0.0	
Total Lost Time (s)	7.5	7.0		7.5	7.0	7.0	8.5	7.0		8.5	7.0	
Lead/Lag	Lead	Lag		Lead	Lag	Lag	Lead	Lag		Lead	Lag	
Lead-Lag Optimize?	Yes	Yes		Yes	Yes	Yes	Yes	Yes		Yes	Yes	
Recall Mode	None	None		None	None	None	None	C-Max		None	C-Max	
Act Effct Green (s)	15.5	35.3	120.0	10.2	30.0	30.0	11.5	29.1	120.0	15.4	33.0	120.0
Actuated g/C Ratio	0.13	0.29	1.00	0.08	0.25	0.25	0.10	0.24	1.00	0.13	0.28	1.00
v/c Ratio	1.11	0.49	0.11	0.53	1.00	0.33	1.04	0.42	0.07	0.70	1.01	0.68
Control Delay	124.2	37.1	0.1	59.4	74.6	6.4	113.6	40.6	0.1	58.8	74.1	2.4
Queue Delay	0.0	0.0	0.0	0.0	0.0	0.0	0.0	0.0	0.0	0.0	0.0	0.0
Total Delay	124.2	37.1	0.1	59.4	74.6	6.4	113.6	40.6	0.1	58.8	74.1	2.4
LOS	F	D	A	E	E	A	F	D	A	E	E	A
Approach Delay		67.7			62.8			66.4			39.3	
Approach LOS		E			E			E			D	

Intersection Summary

Cycle Length: 120
 Actuated Cycle Length: 120
 Offset: 0 (0%), Referenced to phase 2:NBT and 6:SBT, Start of FDW or yellow, Master Intersection
 Natural Cycle: 130
 Control Type: Actuated-Coordinated
 Maximum v/c Ratio: 1.11
 Intersection Signal Delay: 54.4
 Intersection LOS: D
 Intersection Capacity Utilization 96.8%
 ICU Level of Service F
 Analysis Period (min) 15

Splits and Phases: 7: Meridian Rd & Woodmen Rd

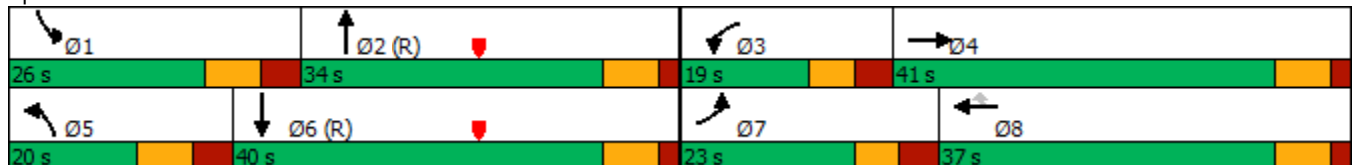

Timings
8: McLaughlin Rd & Woodmen Rd

2044 Total Traffic
AM Peak Hour

Lane Group	EBL	EBT	EBR	WBL	WBT	WBR	NBL	NBT	NBR	SBL	SBT	SBR
Lane Configurations												
Traffic Volume (vph)	100	680	100	50	790	159	75	50	50	134	125	300
Future Volume (vph)	100	680	100	50	790	159	75	50	50	134	125	300
Turn Type	pm+pt	NA	Perm	pm+pt	NA	Perm	pm+pt	NA	Perm	pm+pt	NA	Perm
Protected Phases	5	2		1	6		3	8		7	4	
Permitted Phases	2		2	6		6	8		8	4		4
Detector Phase	5	2	2	1	6	6	3	8	8	7	4	4
Switch Phase												
Minimum Initial (s)	5.0	5.0	5.0	5.0	5.0	5.0	5.0	5.0	5.0	5.0	5.0	5.0
Minimum Split (s)	12.5	25.0	25.0	12.5	25.0	25.0	13.5	25.0	25.0	13.5	25.0	25.0
Total Split (s)	14.0	37.0	37.0	14.0	37.0	37.0	14.0	25.0	25.0	14.0	25.0	25.0
Total Split (%)	15.6%	41.1%	41.1%	15.6%	41.1%	41.1%	15.6%	27.8%	27.8%	15.6%	27.8%	27.8%
Yellow Time (s)	4.0	5.0	5.0	4.0	5.0	5.0	5.0	5.0	5.0	5.0	5.0	5.0
All-Red Time (s)	3.5	2.0	2.0	3.5	2.0	2.0	3.5	2.0	2.0	3.5	2.0	2.0
Lost Time Adjust (s)	0.0	0.0	0.0	0.0	0.0	0.0	0.0	0.0	0.0	0.0	0.0	0.0
Total Lost Time (s)	7.5	7.0	7.0	7.5	7.0	7.0	8.5	7.0	7.0	8.5	7.0	7.0
Lead/Lag	Lead	Lag	Lag	Lead	Lag	Lag	Lead	Lag	Lag	Lead	Lag	Lag
Lead-Lag Optimize?	Yes	Yes	Yes	Yes	Yes	Yes	Yes	Yes	Yes	Yes	Yes	Yes
Recall Mode	None	C-Max	C-Max	None	C-Max	C-Max	None	Max	Max	None	Max	Max
Act Effct Green (s)	39.0	35.6	35.6	37.4	32.8	32.8	22.0	18.0	18.0	23.7	20.8	20.8
Actuated g/C Ratio	0.43	0.40	0.40	0.42	0.36	0.36	0.24	0.20	0.20	0.26	0.23	0.23
v/c Ratio	0.39	0.50	0.13	0.16	0.63	0.22	0.23	0.14	0.10	0.37	0.30	0.52
Control Delay	17.7	23.4	0.3	14.0	27.2	1.3	22.9	30.8	0.4	26.3	32.7	8.9
Queue Delay	0.0	0.0	0.0	0.0	0.0	0.0	0.0	0.0	0.0	0.0	0.0	0.0
Total Delay	17.7	23.4	0.3	14.0	27.2	1.3	22.9	30.8	0.4	26.3	32.7	8.9
LOS	B	C	A	B	C	A	C	C	A	C	C	A
Approach Delay		20.1			22.4			18.8			18.4	
Approach LOS		C			C			B			B	

Intersection Summary

Cycle Length: 90
 Actuated Cycle Length: 90
 Offset: 0 (0%), Referenced to phase 2:EBTL and 6:WBTL, Start of Green
 Natural Cycle: 80
 Control Type: Actuated-Coordinated
 Maximum v/c Ratio: 0.63
 Intersection Signal Delay: 20.5
 Intersection LOS: C
 Intersection Capacity Utilization 62.7%
 ICU Level of Service B
 Analysis Period (min) 15

Splits and Phases: 8: McLaughlin Rd & Woodmen Rd

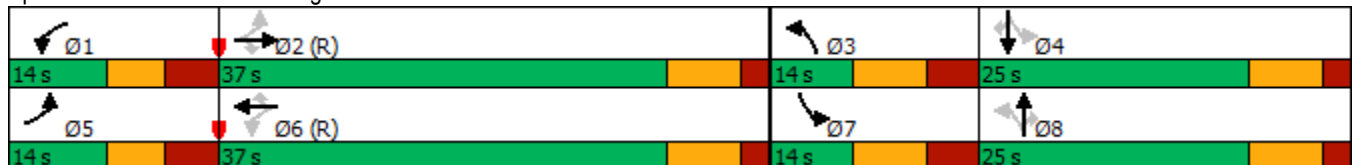

Timings
9: US 24 & Woodmen Rd

2044 Total Traffic
AM Peak Hour

Lane Group	EBL	EBT	EBR	WBL	WBT	WBR	NBL	NBT	NBR	SBL	SBT	SBR
Lane Configurations												
Traffic Volume (vph)	372	145	347	70	118	54	399	744	40	72	917	482
Future Volume (vph)	372	145	347	70	118	54	399	744	40	72	917	482
Turn Type	Prot	NA	Free	pm+pt	NA	Free	Prot	NA	Perm	pm+pt	NA	Free
Protected Phases	7	4		3	8		5	2		1	6	
Permitted Phases			Free	8		Free			2	6		Free
Detector Phase	7	4		3	8		5	2	2	1	6	
Switch Phase												
Minimum Initial (s)	20.0	15.0		5.0	15.0		5.0	15.0	15.0	5.0	15.0	
Minimum Split (s)	25.0	23.0		10.0	23.0		10.0	23.0	23.0	10.0	23.0	
Total Split (s)	27.0	37.0		15.0	25.0		20.0	58.0	58.0	10.0	48.0	
Total Split (%)	22.5%	30.8%		12.5%	20.8%		16.7%	48.3%	48.3%	8.3%	40.0%	
Yellow Time (s)	3.0	3.0		3.0	3.0		3.0	3.0	3.0	3.0	3.0	
All-Red Time (s)	2.0	2.0		2.0	2.0		2.0	2.0	2.0	2.0	2.0	
Lost Time Adjust (s)	0.0	0.0		0.0	0.0		0.0	0.0	0.0	0.0	0.0	
Total Lost Time (s)	5.0	5.0		5.0	5.0		5.0	5.0	5.0	5.0	5.0	
Lead/Lag	Lead	Lag		Lead	Lag		Lead	Lag	Lag	Lead	Lag	
Lead-Lag Optimize?	Yes	Yes		Yes	Yes		Yes	Yes	Yes	Yes	Yes	
Recall Mode	None	None		None	None		None	C-Max	C-Max	None	C-Max	
Act Effct Green (s)	20.6	29.3	120.0	23.5	15.0	120.0	20.7	58.8	58.8	51.5	43.7	120.0
Actuated g/C Ratio	0.17	0.24	1.00	0.20	0.12	1.00	0.17	0.49	0.49	0.43	0.36	1.00
v/c Ratio	0.67	0.34	0.23	0.27	0.29	0.04	0.72	0.32	0.05	0.22	0.53	0.32
Control Delay	52.8	41.4	0.3	31.1	49.6	0.0	54.5	19.7	0.1	14.4	31.4	0.5
Queue Delay	0.0	0.0	0.0	0.0	0.0	0.0	0.0	0.0	0.0	0.0	0.0	0.0
Total Delay	52.8	41.4	0.3	31.1	49.6	0.0	54.5	19.7	0.1	14.4	31.4	0.5
LOS	D	D	A	C	D	A	D	B	A	B	C	A
Approach Delay		29.8			33.3			30.8			20.5	
Approach LOS		C			C			C			C	

Intersection Summary

Cycle Length: 120
 Actuated Cycle Length: 120
 Offset: 0 (0%), Referenced to phase 2:NBT and 6:SBTL, Start of Green
 Natural Cycle: 85
 Control Type: Actuated-Coordinated
 Maximum v/c Ratio: 0.72
 Intersection Signal Delay: 26.7
 Intersection LOS: C
 Intersection Capacity Utilization 70.8%
 ICU Level of Service C
 Analysis Period (min) 15

Splits and Phases: 9: US 24 & Woodmen Rd

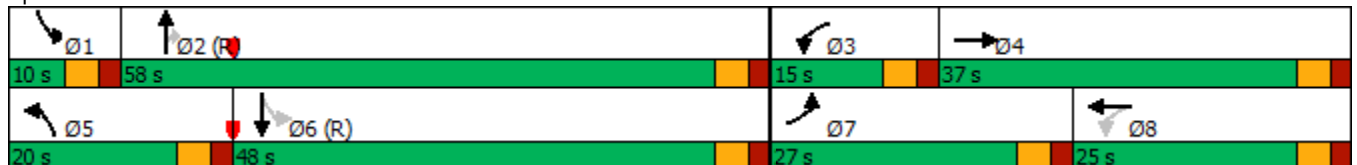

Timings
10: US 24 & Meridian Rd

2044 Total Traffic
AM Peak Hour

Lane Group	EBL	EBT	EBR	WBL	WBT	WBR	NBL	NBT	NBR	SBL	SBT	SBR
Lane Configurations												
Traffic Volume (vph)	30	524	991	40	273	247	272	906	30	216	1093	40
Future Volume (vph)	30	524	991	40	273	247	272	906	30	216	1093	40
Turn Type	pm+pt	NA	Free	pm+pt	NA	Free	Prot	NA	Perm	pm+pt	NA	Perm
Protected Phases	5	2		1	6		3	8		7	4	
Permitted Phases	2		Free	6		Free			8	4		4
Detector Phase	5	2		1	6		3	8	8	7	4	4
Switch Phase												
Minimum Initial (s)	5.0	5.0		5.0	5.0		5.0	5.0	5.0	5.0	5.0	5.0
Minimum Split (s)	11.0	20.0		11.0	20.0		11.0	20.0	20.0	11.0	20.0	20.0
Total Split (s)	11.0	21.0		11.0	21.0		16.0	42.0	42.0	16.0	42.0	42.0
Total Split (%)	12.2%	23.3%		12.2%	23.3%		17.8%	46.7%	46.7%	17.8%	46.7%	46.7%
Yellow Time (s)	3.0	5.0		3.0	5.0		3.0	4.5	4.5	3.0	4.5	4.5
All-Red Time (s)	3.0	2.0		3.0	2.0		3.0	2.0	2.0	3.0	2.0	2.0
Lost Time Adjust (s)	0.0	0.0		0.0	0.0		0.0	0.0	0.0	0.0	0.0	0.0
Total Lost Time (s)	6.0	7.0		6.0	7.0		6.0	6.5	6.5	6.0	6.5	6.5
Lead/Lag	Lead	Lag		Lead	Lag		Lead	Lag	Lag	Lead	Lag	Lag
Lead-Lag Optimize?	Yes	Yes		Yes	Yes		Yes	Yes	Yes	Yes	Yes	Yes
Recall Mode	None	C-Max		None	C-Max		None	None	None	None	None	None
Act Effct Green (s)	29.7	24.7	90.0	30.1	24.8	90.0	9.9	28.3	28.3	38.4	28.1	28.1
Actuated g/C Ratio	0.33	0.27	1.00	0.33	0.28	1.00	0.11	0.31	0.31	0.43	0.31	0.31
v/c Ratio	0.08	0.55	0.64	0.14	0.29	0.16	0.74	0.58	0.05	0.69	0.70	0.07
Control Delay	18.5	30.2	4.3	21.8	29.8	0.2	51.8	27.0	0.1	24.8	29.5	0.2
Queue Delay	0.0	0.0	0.0	0.0	0.0	0.0	0.0	0.0	0.0	0.0	0.0	0.0
Total Delay	18.5	30.2	4.3	21.8	29.8	0.2	51.8	27.0	0.1	24.8	29.5	0.2
LOS	B	C	A	C	C	A	D	C	A	C	C	A
Approach Delay		13.4			16.2			31.9			27.8	
Approach LOS		B			B			C			C	

Intersection Summary

Cycle Length: 90
 Actuated Cycle Length: 90
 Offset: 71 (79%), Referenced to phase 2:EBTL and 6:WBTL, Start of FDW or yellow
 Natural Cycle: 65
 Control Type: Actuated-Coordinated
 Maximum v/c Ratio: 0.74
 Intersection Signal Delay: 22.7
 Intersection LOS: C
 Intersection Capacity Utilization 69.4%
 ICU Level of Service C
 Analysis Period (min) 15

Splits and Phases: 10: US 24 & Meridian Rd

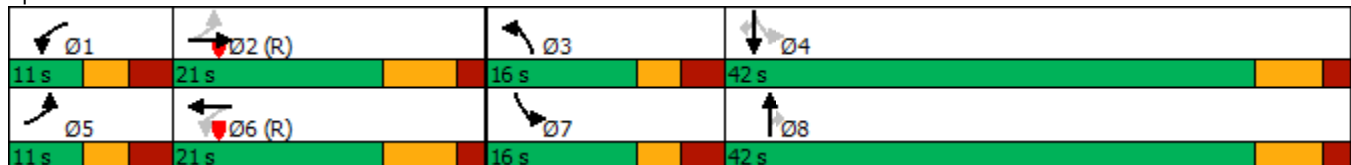

Intersection												
Int Delay, s/veh	0											
Movement	EBL	EBT	EBR	WBL	WBT	WBR	NBL	NBT	NBR	SBL	SBT	SBR
Lane Configurations			↗			↗		↑↑↑	↗		↑↑↑	↗
Traffic Vol, veh/h	0	0	50	0	0	130	0	1053	130	0	1299	35
Future Vol, veh/h	0	0	50	0	0	130	0	1053	130	0	1299	35
Conflicting Peds, #/hr	0	0	0	0	0	0	0	0	0	0	0	0
Sign Control	Stop	Stop	Stop	Stop	Stop	Stop	Free	Free	Free	Free	Free	Free
RT Channelized	-	-	Free	-	-	Free	-	-	None	-	-	None
Storage Length	-	-	0	-	-	0	-	-	-	-	-	-
Veh in Median Storage, #	-	0	-	-	0	-	-	0	-	-	0	-
Grade, %	-	0	-	-	0	-	-	0	-	-	0	-
Peak Hour Factor	94	94	94	94	94	94	94	94	94	94	94	94
Heavy Vehicles, %	2	2	2	2	2	2	2	2	2	2	2	2
Mvmt Flow	0	0	53	0	0	138	0	1120	138	0	1382	37

Major/Minor	Minor2		Minor1		Major1			Major2				
Conflicting Flow All	-	-	-	-	-	-	-	0	0	-	-	0
Stage 1	-	-	-	-	-	-	-	-	-	-	-	-
Stage 2	-	-	-	-	-	-	-	-	-	-	-	-
Critical Hdwy	-	-	-	-	-	-	-	-	-	-	-	-
Critical Hdwy Stg 1	-	-	-	-	-	-	-	-	-	-	-	-
Critical Hdwy Stg 2	-	-	-	-	-	-	-	-	-	-	-	-
Follow-up Hdwy	-	-	-	-	-	-	-	-	-	-	-	-
Pot Cap-1 Maneuver	0	0	0	0	0	0	0	-	-	0	-	-
Stage 1	0	0	0	0	0	0	0	-	-	0	-	-
Stage 2	0	0	0	0	0	0	0	-	-	0	-	-
Platoon blocked, %	-	-	-	-	-	-	-	-	-	-	-	-
Mov Cap-1 Maneuver	-	-	-	-	-	-	-	-	-	-	-	-
Mov Cap-2 Maneuver	-	-	-	-	-	-	-	-	-	-	-	-
Stage 1	-	-	-	-	-	-	-	-	-	-	-	-
Stage 2	-	-	-	-	-	-	-	-	-	-	-	-

Approach	EB	WB	NB	SB
HCM Control Delay, s	0	0	0	0
HCM LOS	A	A		

Minor Lane/Major Mvmt	NBT	NBR	EBLn1WBLn1	SBT	SBR
Capacity (veh/h)	-	-	-	-	-
HCM Lane V/C Ratio	-	-	-	-	-
HCM Control Delay (s)	-	-	0	0	-
HCM Lane LOS	-	-	A	A	-
HCM 95th %tile Q(veh)	-	-	-	-	-

Intersection						
Int Delay, s/veh	0.3					
Movement	EBL	EBR	NBL	NBT	SBT	SBR
Lane Configurations						
Traffic Vol, veh/h	2	1	4	64	89	4
Future Vol, veh/h	2	1	4	64	89	4
Conflicting Peds, #/hr	0	0	0	0	0	0
Sign Control	Stop	Stop	Free	Free	Free	Free
RT Channelized	-	None	-	None	-	None
Storage Length	0	-	-	-	-	-
Veh in Median Storage, #	0	-	-	0	0	-
Grade, %	0	-	-	0	0	-
Peak Hour Factor	92	92	92	92	92	92
Heavy Vehicles, %	2	2	2	2	2	2
Mvmt Flow	2	1	4	70	97	4

Major/Minor	Minor2	Major1		Major2	
Conflicting Flow All	177	99	101	0	0
Stage 1	99	-	-	-	-
Stage 2	78	-	-	-	-
Critical Hdwy	6.42	6.22	4.12	-	-
Critical Hdwy Stg 1	5.42	-	-	-	-
Critical Hdwy Stg 2	5.42	-	-	-	-
Follow-up Hdwy	3.518	3.318	2.218	-	-
Pot Cap-1 Maneuver	813	957	1491	-	-
Stage 1	925	-	-	-	-
Stage 2	945	-	-	-	-
Platoon blocked, %				-	-
Mov Cap-1 Maneuver	811	957	1491	-	-
Mov Cap-2 Maneuver	811	-	-	-	-
Stage 1	922	-	-	-	-
Stage 2	945	-	-	-	-

Approach	EB	NB	SB
HCM Control Delay, s	9.2	0.4	0
HCM LOS	A		

Minor Lane/Major Mvmt	NBL	NBT	EBLn1	SBT	SBR
Capacity (veh/h)	1491	-	854	-	-
HCM Lane V/C Ratio	0.003	-	0.004	-	-
HCM Control Delay (s)	7.4	0	9.2	-	-
HCM Lane LOS	A	A	A	-	-
HCM 95th %tile Q(veh)	0	-	0	-	-

Intersection												
Int Delay, s/veh	3.4											
Movement	EBL	EBT	EBR	WBL	WBT	WBR	NBL	NBT	NBR	SBL	SBT	SBR
Lane Configurations	↖	↗		↖	↗			↕			↕	
Traffic Vol, veh/h	0	270	0	53	258	23	0	0	21	85	0	0
Future Vol, veh/h	0	270	0	53	258	23	0	0	21	85	0	0
Conflicting Peds, #/hr	0	0	0	0	0	0	0	0	0	0	0	0
Sign Control	Free	Free	Free	Free	Free	Free	Stop	Stop	Stop	Stop	Stop	Stop
RT Channelized	-	-	None	-	-	None	-	-	None	-	-	None
Storage Length	135	-	-	190	-	-	-	-	-	-	-	-
Veh in Median Storage, #	-	0	-	-	0	-	-	0	-	-	0	-
Grade, %	-	0	-	-	0	-	-	0	-	-	0	-
Peak Hour Factor	92	92	92	92	92	92	92	92	92	92	92	92
Heavy Vehicles, %	2	2	2	2	2	2	2	2	2	2	2	2
Mvmt Flow	0	293	0	58	280	25	0	0	23	92	0	0

Major/Minor	Major1			Major2			Minor1			Minor2		
Conflicting Flow All	305	0	0	293	0	0	702	714	293	714	702	293
Stage 1	-	-	-	-	-	-	293	293	-	409	409	-
Stage 2	-	-	-	-	-	-	409	421	-	305	293	-
Critical Hdwy	4.12	-	-	4.12	-	-	7.12	6.52	6.22	7.12	6.52	6.22
Critical Hdwy Stg 1	-	-	-	-	-	-	6.12	5.52	-	6.12	5.52	-
Critical Hdwy Stg 2	-	-	-	-	-	-	6.12	5.52	-	6.12	5.52	-
Follow-up Hdwy	2.218	-	-	2.218	-	-	3.518	4.018	3.318	3.518	4.018	3.318
Pot Cap-1 Maneuver	1256	-	-	1269	-	-	353	357	746	346	362	746
Stage 1	-	-	-	-	-	-	715	670	-	619	596	-
Stage 2	-	-	-	-	-	-	619	589	-	705	670	-
Platoon blocked, %	-	-	-	-	-	-	-	-	-	-	-	-
Mov Cap-1 Maneuver	1256	-	-	1269	-	-	341	341	746	324	345	746
Mov Cap-2 Maneuver	-	-	-	-	-	-	341	341	-	324	345	-
Stage 1	-	-	-	-	-	-	715	670	-	619	569	-
Stage 2	-	-	-	-	-	-	591	562	-	683	670	-

Approach	EB	WB	NB	SB
HCM Control Delay, s	0	1.3	10	20.5
HCM LOS			B	C

Minor Lane/Major Mvmt	NBLn1	EBL	EBT	EBR	WBL	WBT	WBR	SBLn1
Capacity (veh/h)	746	1256	-	-	1269	-	-	324
HCM Lane V/C Ratio	0.031	-	-	-	0.045	-	-	0.285
HCM Control Delay (s)	10	0	-	-	8	-	-	20.5
HCM Lane LOS	B	A	-	-	A	-	-	C
HCM 95th %tile Q(veh)	0.1	0	-	-	0.1	-	-	1.2

MOVEMENT FLOWS FOR SITE (INPUT)

Approach movement input flow rates (veh/h)

All Movement Classes

▼ Site: 2 [2043 Total PM - Single Southeastbound Approach - Copy (Site Folder: General)]

Woodmen/Retail Row

Site Category: 2043 Total PM
Roundabout

Use the button below to open or close all popup boxes. Click value labels to open selected ones.
Click and drag popup boxes to move to preferred positions.

Close All Popups

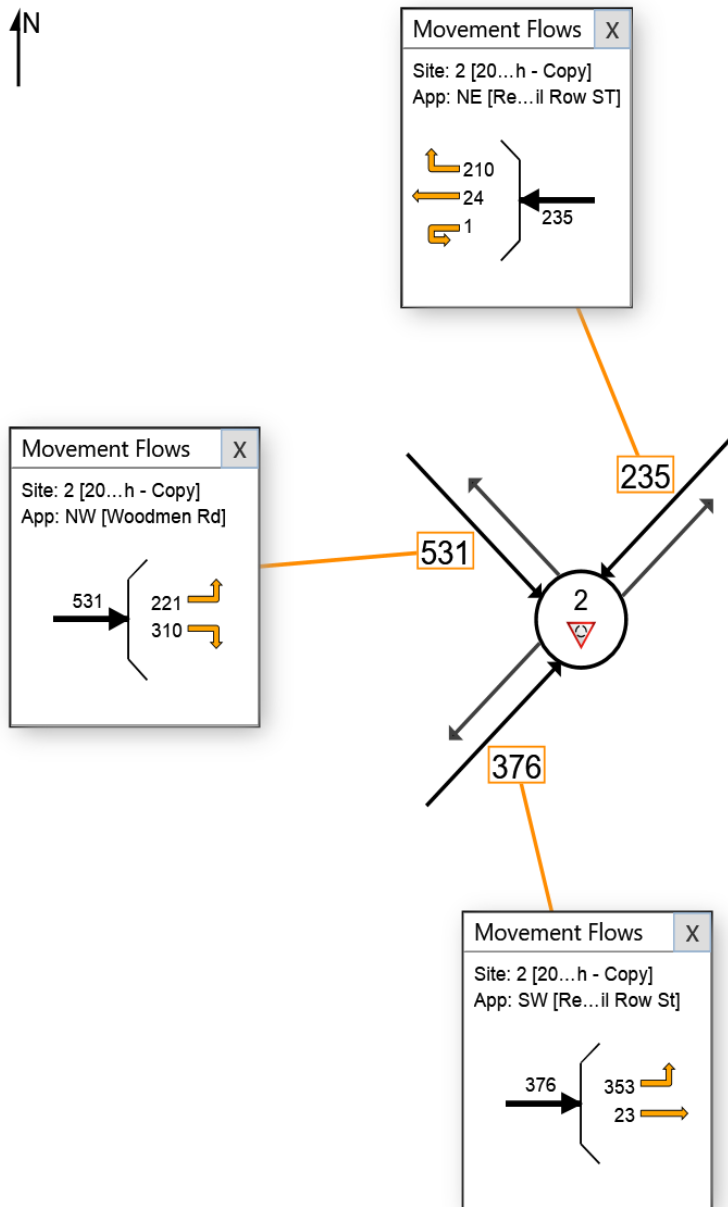

LANE SUMMARY

Site: 2 [2043 Total PM - Single Southeastbound Approach - Copy (Site Folder: General)]

Woodmen/Retail Row

Site Category: 2043 Total PM Roundabout

Lane Use and Performance													
	DEMAND FLOWS		Cap.	Deg. Satn	Lane Util.	Aver. Delay	Level of Service	95% BACK OF QUEUE		Lane Config	Lane Length	Cap. Adj.	Prob. Block.
	[Total veh/h]	[HV %]						[Veh]	[Dist]				
	veh/h	%	veh/h	v/c	%	sec			ft		ft	%	%
NorthEast: Retail Row ST													
Lane 1 ^d	255	2.0	908	0.281	100	6.9	LOS A	1.3	34.0	Full	1600	0.0	0.0
Approach	255	2.0		0.281		6.9	LOS A	1.3	34.0				
NorthWest: Woodmen Rd													
Lane 1 ^d	577	2.0	1315	0.439	100	7.1	LOS A	3.1	78.5	Full	1600	0.0	0.0
Approach	577	2.0		0.439		7.1	LOS A	3.1	78.5				
SouthWest: Retail Row St													
Lane 1 ^d	409	2.0	1053	0.388	100	7.5	LOS A	2.2	55.5	Full	1600	0.0	0.0
Approach	409	2.0		0.388		7.5	LOS A	2.2	55.5				
Intersection	1241	2.0		0.439		7.2	LOS A	3.1	78.5				

Site Level of Service (LOS) Method: Delay & v/c (HCM 6). Site LOS Method is specified in the Parameter Settings dialog (Site tab). Roundabout LOS Method: Same as Sign Control.

Lane LOS values are based on average delay and v/c ratio (degree of saturation) per lane.

LOS F will result if v/c > 1 irrespective of lane delay value (does not apply for approaches and intersection).

Intersection and Approach LOS values are based on average delay for all lanes (v/c not used as specified in HCM 6).

Roundabout Capacity Model: US HCM 6.

Delay Model: HCM Delay Formula (Geometric Delay is not included).

Queue Model: HCM Queue Formula.

Gap-Acceptance Capacity: Traditional M1.

HV (%) values are calculated for All Movement Classes of All Heavy Vehicle Model Designation.

^d Dominant lane on roundabout approach

SIDRA INTERSECTION 9.0 | Copyright © 2000-2020 Akcelik and Associates Pty Ltd | sidrasolutions.com

Organisation: LSC TRANSPORTATION CONSULTANTS, INC. | Licence: PLUS / 1PC | Processed: Friday, October 6, 2023 10:09:45 AM

Project: G:\Shared drives\CS Engineering - 2019-current\2020\204120 - FalconField Prelim Plan\Sidra\2020-06-June\Woodmen & Retail Row St single sb approach.sip9

Intersection						
Int Delay, s/veh	4					
Movement	EBL	EBT	WBT	WBR	SBL	SBR
Lane Configurations						
Traffic Vol, veh/h	105	139	121	1	1	113
Future Vol, veh/h	105	139	121	1	1	113
Conflicting Peds, #/hr	0	0	0	0	0	0
Sign Control	Free	Free	Free	Free	Stop	Stop
RT Channelized	-	None	-	None	-	None
Storage Length	120	-	-	-	0	-
Veh in Median Storage, #	-	0	0	-	0	-
Grade, %	-	0	0	-	0	-
Peak Hour Factor	92	92	92	92	92	92
Heavy Vehicles, %	2	2	2	2	2	2
Mvmt Flow	114	151	132	1	1	123

Major/Minor	Major1	Major2	Minor2
Conflicting Flow All	133	0	0
Stage 1	-	-	133
Stage 2	-	-	379
Critical Hdwy	4.12	-	6.42
Critical Hdwy Stg 1	-	-	5.42
Critical Hdwy Stg 2	-	-	5.42
Follow-up Hdwy	2.218	-	3.518
Pot Cap-1 Maneuver	1452	-	522
Stage 1	-	-	893
Stage 2	-	-	692
Platoon blocked, %	-	-	-
Mov Cap-1 Maneuver	1452	-	481
Mov Cap-2 Maneuver	-	-	481
Stage 1	-	-	822
Stage 2	-	-	692

Approach	EB	WB	SB
HCM Control Delay, s	3.3	0	9.6
HCM LOS			A

Minor Lane/Major Mvmt	EBL	EBT	WBT	WBR	SBLn1
Capacity (veh/h)	1452	-	-	-	909
HCM Lane V/C Ratio	0.079	-	-	-	0.136
HCM Control Delay (s)	7.7	-	-	-	9.6
HCM Lane LOS	A	-	-	-	A
HCM 95th %tile Q(veh)	0.3	-	-	-	0.5

Intersection						
Int Delay, s/veh	0.5					
Movement	EBT	EBR	WBL	WBT	NBL	NBR
Lane Configurations						
Traffic Vol, veh/h	113	31	1	107	13	0
Future Vol, veh/h	113	31	1	107	13	0
Conflicting Peds, #/hr	0	0	0	0	0	0
Sign Control	Free	Free	Free	Free	Stop	Stop
RT Channelized	-	None	-	None	-	None
Storage Length	-	-	-	-	0	-
Veh in Median Storage, #	0	-	-	0	0	-
Grade, %	0	-	-	0	0	-
Peak Hour Factor	92	92	92	92	92	92
Heavy Vehicles, %	2	2	2	2	2	2
Mvmt Flow	123	34	1	116	14	0

Major/Minor	Major1	Major2	Minor1		
Conflicting Flow All	0	0	157	0	258 140
Stage 1	-	-	-	-	140 -
Stage 2	-	-	-	-	118 -
Critical Hdwy	-	-	4.12	-	6.42 6.22
Critical Hdwy Stg 1	-	-	-	-	5.42 -
Critical Hdwy Stg 2	-	-	-	-	5.42 -
Follow-up Hdwy	-	-	2.218	-	3.518 3.318
Pot Cap-1 Maneuver	-	-	1423	-	731 908
Stage 1	-	-	-	-	887 -
Stage 2	-	-	-	-	907 -
Platoon blocked, %	-	-	-	-	-
Mov Cap-1 Maneuver	-	-	1423	-	730 908
Mov Cap-2 Maneuver	-	-	-	-	730 -
Stage 1	-	-	-	-	887 -
Stage 2	-	-	-	-	906 -

Approach	EB	WB	NB
HCM Control Delay, s	0	0.1	10
HCM LOS			B

Minor Lane/Major Mvmt	NBLn1	EBT	EBR	WBL	WBT
Capacity (veh/h)	730	-	-	1423	-
HCM Lane V/C Ratio	0.019	-	-	0.001	-
HCM Control Delay (s)	10	-	-	7.5	0
HCM Lane LOS	B	-	-	A	A
HCM 95th %tile Q(veh)	0.1	-	-	0	-

Intersection						
Int Delay, s/veh	0.2					
Movement	EBT	EBR	WBL	WBT	NBL	NBR
Lane Configurations						
Traffic Vol, veh/h	106	7	2	105	3	1
Future Vol, veh/h	106	7	2	105	3	1
Conflicting Peds, #/hr	0	0	0	0	0	0
Sign Control	Free	Free	Free	Free	Stop	Stop
RT Channelized	-	None	-	None	-	None
Storage Length	-	-	-	-	0	-
Veh in Median Storage, #	0	-	-	0	0	-
Grade, %	0	-	-	0	0	-
Peak Hour Factor	92	92	92	92	92	92
Heavy Vehicles, %	2	2	2	2	2	2
Mvmt Flow	115	8	2	114	3	1

Major/Minor	Major1	Major2	Minor1	Minor2	Minor3
Conflicting Flow All	0	0	123	0	237
Stage 1	-	-	-	-	119
Stage 2	-	-	-	-	118
Critical Hdwy	-	-	4.12	-	6.42
Critical Hdwy Stg 1	-	-	-	-	5.42
Critical Hdwy Stg 2	-	-	-	-	5.42
Follow-up Hdwy	-	-	2.218	-	3.518
Pot Cap-1 Maneuver	-	-	1464	-	751
Stage 1	-	-	-	-	906
Stage 2	-	-	-	-	907
Platoon blocked, %	-	-	-	-	-
Mov Cap-1 Maneuver	-	-	1464	-	750
Mov Cap-2 Maneuver	-	-	-	-	750
Stage 1	-	-	-	-	906
Stage 2	-	-	-	-	906

Approach	EB	WB	NB
HCM Control Delay, s	0	0.1	9.6
HCM LOS			A

Minor Lane/Major Mvmt	NBLn1	EBT	EBR	WBL	WBT
Capacity (veh/h)	789	-	-	1464	-
HCM Lane V/C Ratio	0.006	-	-	0.001	-
HCM Control Delay (s)	9.6	-	-	7.5	0
HCM Lane LOS	A	-	-	A	A
HCM 95th %tile Q(veh)	0	-	-	0	-

Timings
7: Meridian Rd & Woodmen Rd

2044 Total Traffic
PM Peak Hour

Lane Group	EBL	EBT	EBR	WBL	WBT	WBR	NBL	NBT	NBR	SBL	SBT	SBR
Lane Configurations												
Traffic Volume (vph)	785	704	373	229	622	299	468	875	203	499	700	602
Future Volume (vph)	785	704	373	229	622	299	468	875	203	499	700	602
Turn Type	Prot	NA	Free	Prot	NA	Perm	Prot	NA	Free	Prot	NA	Free
Protected Phases	7	4		3	8		5	2		1	6	
Permitted Phases			Free			8			Free			Free
Detector Phase	7	4		3	8	8	5	2		1	6	
Switch Phase												
Minimum Initial (s)	5.0	15.0		5.0	15.0	15.0	5.0	15.0		5.0	15.0	
Minimum Split (s)	12.5	22.0		12.5	22.0	22.0	13.5	22.0		13.5	22.0	
Total Split (s)	32.0	43.0		18.0	29.0	29.0	23.0	36.0		23.0	36.0	
Total Split (%)	26.7%	35.8%		15.0%	24.2%	24.2%	19.2%	30.0%		19.2%	30.0%	
Yellow Time (s)	3.0	3.0		3.0	3.0	3.0	3.0	3.0		3.0	3.0	
All-Red Time (s)	2.0	2.0		2.0	2.0	2.0	2.0	2.0		2.0	2.0	
Lost Time Adjust (s)	0.0	0.0		0.0	0.0	0.0	0.0	0.0		0.0	0.0	
Total Lost Time (s)	5.0	5.0		5.0	5.0	5.0	5.0	5.0		5.0	5.0	
Lead/Lag	Lead	Lag		Lead	Lag	Lag	Lead	Lag		Lead	Lag	
Lead-Lag Optimize?	Yes	Yes		Yes	Yes	Yes	Yes	Yes		Yes	Yes	
Recall Mode	None	None		None	None	None	None	C-Max		None	C-Max	
Act Effct Green (s)	27.0	38.7	120.0	12.2	23.9	23.9	18.1	31.0	120.0	18.1	31.0	120.0
Actuated g/C Ratio	0.22	0.32	1.00	0.10	0.20	0.20	0.15	0.26	1.00	0.15	0.26	1.00
v/c Ratio	1.06	0.64	0.25	0.69	0.92	0.57	0.94	1.00	0.13	1.00	0.80	0.40
Control Delay	94.0	38.1	0.4	78.9	50.9	11.5	78.4	73.7	0.2	91.7	49.2	0.7
Queue Delay	0.0	0.0	0.0	0.0	0.0	0.0	0.0	0.0	0.0	0.0	0.0	0.0
Total Delay	94.0	38.1	0.4	78.9	50.9	11.5	78.4	73.7	0.2	91.7	49.2	0.7
LOS	F	D	A	E	D	B	E	E	A	F	D	A
Approach Delay		54.1			46.2			65.5			44.8	
Approach LOS		D			D			E			D	

Intersection Summary

Cycle Length: 120
 Actuated Cycle Length: 120
 Offset: 0 (0%), Referenced to phase 2:NBT and 6:SBT, Start of FDW or yellow, Master Intersection
 Natural Cycle: 110
 Control Type: Actuated-Coordinated
 Maximum v/c Ratio: 1.06
 Intersection Signal Delay: 52.8
 Intersection LOS: D
 Intersection Capacity Utilization 94.7%
 ICU Level of Service F
 Analysis Period (min) 15

Splits and Phases: 7: Meridian Rd & Woodmen Rd

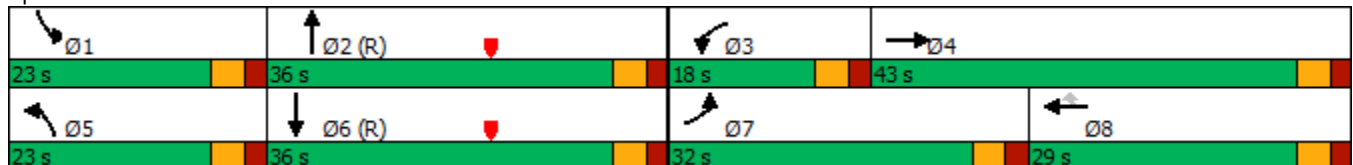

Timings
8: McLaughlin Rd & Woodmen Rd

2044 Total Traffic
PM Peak Hour

Lane Group	EBL	EBT	EBR	WBL	WBT	WBR	NBL	NBT	NBR	SBL	SBT	SBR
Lane Configurations												
Traffic Volume (vph)	300	957	150	100	800	291	150	200	150	217	150	200
Future Volume (vph)	300	957	150	100	800	291	150	200	150	217	150	200
Turn Type	pm+pt	NA	Perm	pm+pt	NA	Perm	pm+pt	NA	Perm	pm+pt	NA	Perm
Protected Phases	5	2		1	6		3	8		7	4	
Permitted Phases	2		2	6		6	8		8	4		4
Detector Phase	5	2	2	1	6	6	3	8	8	7	4	4
Switch Phase												
Minimum Initial (s)	5.0	5.0	5.0	5.0	5.0	5.0	5.0	5.0	5.0	5.0	5.0	5.0
Minimum Split (s)	12.5	25.0	25.0	12.5	25.0	25.0	13.5	25.0	25.0	13.5	25.0	25.0
Total Split (s)	24.0	57.0	57.0	15.0	48.0	48.0	15.0	29.0	29.0	19.0	33.0	33.0
Total Split (%)	20.0%	47.5%	47.5%	12.5%	40.0%	40.0%	12.5%	24.2%	24.2%	15.8%	27.5%	27.5%
Yellow Time (s)	4.0	5.0	5.0	4.0	5.0	5.0	5.0	5.0	5.0	5.0	5.0	5.0
All-Red Time (s)	3.5	2.0	2.0	3.5	2.0	2.0	3.5	2.0	2.0	3.5	2.0	2.0
Lost Time Adjust (s)	0.0	0.0	0.0	0.0	0.0	0.0	0.0	0.0	0.0	0.0	0.0	0.0
Total Lost Time (s)	7.5	7.0	7.0	7.5	7.0	7.0	8.5	7.0	7.0	8.5	7.0	7.0
Lead/Lag	Lead	Lag	Lag	Lead	Lag	Lag	Lead	Lag	Lag	Lead	Lag	Lag
Lead-Lag Optimize?	Yes	Yes	Yes	Yes	Yes	Yes	Yes	Yes	Yes	Yes	Yes	Yes
Recall Mode	None	C-Max	C-Max	None	C-Max	C-Max	None	Max	Max	None	Max	Max
Act Effct Green (s)	64.4	50.2	50.2	48.4	41.6	41.6	27.0	22.0	22.0	35.0	26.0	26.0
Actuated g/C Ratio	0.54	0.42	0.42	0.40	0.35	0.35	0.22	0.18	0.18	0.29	0.22	0.22
v/c Ratio	0.86	0.67	0.20	0.44	0.67	0.40	0.51	0.60	0.31	0.73	0.38	0.38
Control Delay	55.0	51.6	15.6	27.0	42.3	12.3	39.7	53.4	1.7	48.2	43.5	4.2
Queue Delay	0.0	0.0	0.0	0.0	0.0	0.0	0.0	0.0	0.0	0.0	0.0	0.0
Total Delay	55.0	51.6	15.6	27.0	42.3	12.3	39.7	53.4	1.7	48.2	43.5	4.2
LOS	D	D	B	C	D	B	D	D	A	D	D	A
Approach Delay		48.5			33.7			33.7			31.4	
Approach LOS		D			C			C			C	

Intersection Summary

Cycle Length: 120
 Actuated Cycle Length: 120
 Offset: 118 (98%), Referenced to phase 2:EBTL and 6:WBTL, Start of Green
 Natural Cycle: 90
 Control Type: Actuated-Coordinated
 Maximum v/c Ratio: 0.86
 Intersection Signal Delay: 39.0
 Intersection LOS: D
 Intersection Capacity Utilization 85.0%
 ICU Level of Service E
 Analysis Period (min) 15

Splits and Phases: 8: McLaughlin Rd & Woodmen Rd

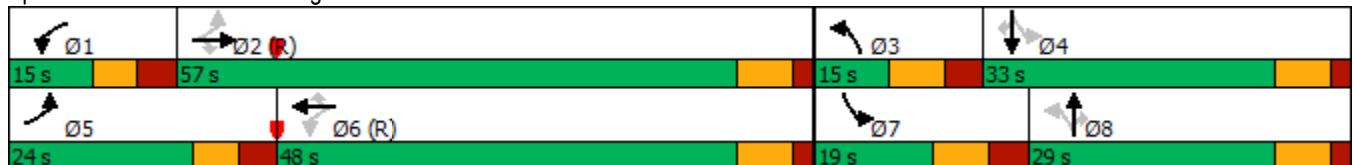

Timings
9: US 24 & Woodmen Rd

2044 Total Traffic
PM Peak Hour

Lane Group	EBL	EBT	EBR	WBL	WBT	WBR	NBL	NBT	NBR	SBL	SBT	SBR
Lane Configurations												
Traffic Volume (vph)	786	306	232	74	303	186	436	1572	171	107	1052	452
Future Volume (vph)	786	306	232	74	303	186	436	1572	171	107	1052	452
Turn Type	Prot	NA	Free	pm+pt	NA	Free	Prot	NA	Perm	pm+pt	NA	Free
Protected Phases	7	4		3	8		5	2		1	6	
Permitted Phases			Free	8		Free			2	6		Free
Detector Phase	7	4		3	8		5	2	2	1	6	
Switch Phase												
Minimum Initial (s)	5.0	15.0		5.0	15.0		20.0	15.0	15.0	5.0	15.0	
Minimum Split (s)	10.0	23.0		10.0	23.0		25.0	23.0	23.0	10.0	23.0	
Total Split (s)	38.0	53.0		12.0	27.0		27.0	45.0	45.0	10.0	28.0	
Total Split (%)	31.7%	44.2%		10.0%	22.5%		22.5%	37.5%	37.5%	8.3%	23.3%	
Yellow Time (s)	3.0	3.0		3.0	3.0		3.0	3.0	3.0	3.0	3.0	
All-Red Time (s)	2.0	2.0		2.0	2.0		2.0	2.0	2.0	2.0	2.0	
Lost Time Adjust (s)	0.0	0.0		0.0	0.0		0.0	0.0	0.0	0.0	0.0	
Total Lost Time (s)	5.0	5.0		5.0	5.0		5.0	5.0	5.0	5.0	5.0	
Lead/Lag	Lead	Lag		Lead	Lag		Lead	Lag	Lag	Lead	Lag	
Lead-Lag Optimize?	Yes	Yes		Yes	Yes		Yes	Yes	Yes	Yes	Yes	
Recall Mode	None	None		None	None		None	C-Max	C-Max	None	C-Max	
Act Effct Green (s)	32.0	44.2	120.0	23.7	16.9	120.0	21.7	42.2	42.2	38.5	29.5	120.0
Actuated g/C Ratio	0.27	0.37	1.00	0.20	0.14	1.00	0.18	0.35	0.35	0.32	0.25	1.00
v/c Ratio	0.91	0.48	0.16	0.32	0.65	0.13	0.75	0.94	0.27	0.58	0.90	0.30
Control Delay	76.9	38.0	0.2	26.0	55.0	0.2	54.7	49.0	5.1	37.4	54.7	0.5
Queue Delay	0.0	0.0	0.0	0.0	0.0	0.0	0.0	0.0	0.0	0.0	0.0	0.0
Total Delay	76.9	38.0	0.2	26.0	55.0	0.2	54.7	49.0	5.1	37.4	54.7	0.5
LOS	E	D	A	C	D	A	D	D	A	D	D	A
Approach Delay		54.4			33.0			46.7			38.4	
Approach LOS		D			C			D			D	

Intersection Summary

Cycle Length: 120
 Actuated Cycle Length: 120
 Offset: 61 (51%), Referenced to phase 2:NBT and 6:SBTL, Start of Green
 Natural Cycle: 105
 Control Type: Actuated-Coordinated
 Maximum v/c Ratio: 0.94
 Intersection Signal Delay: 44.8
 Intersection LOS: D
 Intersection Capacity Utilization 88.6%
 ICU Level of Service E
 Analysis Period (min) 15

Splits and Phases: 9: US 24 & Woodmen Rd

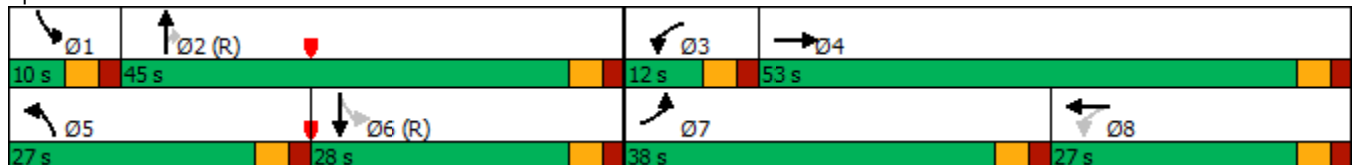

Timings
10: US 24 & Meridian Rd

2044 Total Traffic
PM Peak Hour

Lane Group	EBL	EBT	EBR	WBL	WBT	WBR	NBL	NBT	NBR	SBL	SBT	SBR
Lane Configurations												
Traffic Volume (vph)	80	347	412	60	495	240	804	1814	80	173	1185	60
Future Volume (vph)	80	347	412	60	495	240	804	1814	80	173	1185	60
Turn Type	pm+pt	NA	Free	pm+pt	NA	Free	Prot	NA	Perm	pm+pt	NA	Perm
Protected Phases	5	2		1	6		3	8		7	4	
Permitted Phases	2		Free	6		Free			8	4		4
Detector Phase	5	2		1	6		3	8	8	7	4	4
Switch Phase												
Minimum Initial (s)	5.0	5.0		5.0	5.0		5.0	5.0	5.0	5.0	5.0	5.0
Minimum Split (s)	11.0	20.0		11.0	20.0		11.0	20.0	20.0	11.0	20.0	20.0
Total Split (s)	11.0	21.0		11.0	21.0		28.0	42.0	42.0	16.0	30.0	30.0
Total Split (%)	12.2%	23.3%		12.2%	23.3%		31.1%	46.7%	46.7%	17.8%	33.3%	33.3%
Yellow Time (s)	3.0	5.0		3.0	5.0		3.0	4.5	4.5	3.0	4.5	4.5
All-Red Time (s)	3.0	2.0		3.0	2.0		3.0	2.0	2.0	3.0	2.0	2.0
Lost Time Adjust (s)	0.0	0.0		0.0	0.0		0.0	0.0	0.0	0.0	0.0	0.0
Total Lost Time (s)	6.0	7.0		6.0	7.0		6.0	6.5	6.5	6.0	6.5	6.5
Lead/Lag	Lead	Lag		Lead	Lag		Lead	Lag	Lag	Lead	Lag	Lag
Lead-Lag Optimize?	Yes	Yes		Yes	Yes		Yes	Yes	Yes	Yes	Yes	Yes
Recall Mode	None	C-Max		None	C-Max		None	None	None	None	None	None
Act Effct Green (s)	21.2	16.2	90.0	21.2	16.2	90.0	22.0	36.3	36.3	33.2	23.5	23.5
Actuated g/C Ratio	0.24	0.18	1.00	0.24	0.18	1.00	0.24	0.40	0.40	0.37	0.26	0.26
v/c Ratio	0.45	0.58	0.28	0.25	0.83	0.16	1.02	0.94	0.11	0.69	0.95	0.10
Control Delay	28.2	32.7	0.8	26.7	49.7	0.2	71.0	37.1	0.3	32.0	48.9	0.3
Queue Delay	0.0	0.0	0.0	0.0	0.0	0.0	0.0	0.0	0.0	0.0	0.0	0.0
Total Delay	28.2	32.7	0.8	26.7	49.7	0.2	71.0	37.1	0.3	32.0	48.9	0.3
LOS	C	C	A	C	D	A	E	D	A	C	D	A
Approach Delay		16.6			33.1			46.1			44.8	
Approach LOS		B			C			D			D	

Intersection Summary

Cycle Length: 90
 Actuated Cycle Length: 90
 Offset: 71 (79%), Referenced to phase 2:EBTL and 6:WBTL, Start of FDW or yellow
 Natural Cycle: 90
 Control Type: Actuated-Coordinated
 Maximum v/c Ratio: 1.02
 Intersection Signal Delay: 39.7
 Intersection LOS: D
 Intersection Capacity Utilization 85.2%
 ICU Level of Service E
 Analysis Period (min) 15

Splits and Phases: 10: US 24 & Meridian Rd

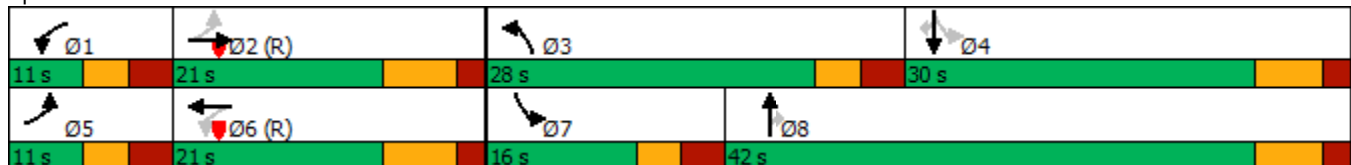

Intersection												
Int Delay, s/veh	0											
Movement	EBL	EBT	EBR	WBL	WBT	WBR	NBL	NBT	NBR	SBL	SBT	SBR
Lane Configurations			↗			↗		↑↑↑	↗		↑↑↑	↗
Traffic Vol, veh/h	0	0	75	0	0	175	0	2004	130	0	1343	15
Future Vol, veh/h	0	0	75	0	0	175	0	2004	130	0	1343	15
Conflicting Peds, #/hr	0	0	0	0	0	0	0	0	0	0	0	0
Sign Control	Stop	Stop	Stop	Stop	Stop	Stop	Free	Free	Free	Free	Free	Free
RT Channelized	-	-	Free	-	-	Free	-	-	None	-	-	None
Storage Length	-	-	0	-	-	0	-	-	-	-	-	-
Veh in Median Storage, #	-	0	-	-	0	-	-	0	-	-	0	-
Grade, %	-	0	-	-	0	-	-	0	-	-	0	-
Peak Hour Factor	90	90	90	90	90	90	90	94	90	90	94	90
Heavy Vehicles, %	2	2	2	2	2	2	2	2	2	2	2	2
Mvmt Flow	0	0	83	0	0	194	0	2132	144	0	1429	17

Major/Minor	Minor2		Minor1			Major1			Major2			
Conflicting Flow All	-	-	-	-	-	-	-	0	0	-	-	0
Stage 1	-	-	-	-	-	-	-	-	-	-	-	-
Stage 2	-	-	-	-	-	-	-	-	-	-	-	-
Critical Hdwy	-	-	-	-	-	-	-	-	-	-	-	-
Critical Hdwy Stg 1	-	-	-	-	-	-	-	-	-	-	-	-
Critical Hdwy Stg 2	-	-	-	-	-	-	-	-	-	-	-	-
Follow-up Hdwy	-	-	-	-	-	-	-	-	-	-	-	-
Pot Cap-1 Maneuver	0	0	0	0	0	0	0	-	-	0	-	-
Stage 1	0	0	0	0	0	0	0	-	-	0	-	-
Stage 2	0	0	0	0	0	0	0	-	-	0	-	-
Platoon blocked, %	-	-	-	-	-	-	-	-	-	-	-	-
Mov Cap-1 Maneuver	-	-	-	-	-	-	-	-	-	-	-	-
Mov Cap-2 Maneuver	-	-	-	-	-	-	-	-	-	-	-	-
Stage 1	-	-	-	-	-	-	-	-	-	-	-	-
Stage 2	-	-	-	-	-	-	-	-	-	-	-	-

Approach	EB		WB			NB			SB		
HCM Control Delay, s	0		0			0			0		
HCM LOS	A		A								

Minor Lane/Major Mvmt	NBT	NBR	EBLn1WBLn1	SBT	SBR
Capacity (veh/h)	-	-	-	-	-
HCM Lane V/C Ratio	-	-	-	-	-
HCM Control Delay (s)	-	-	0	0	-
HCM Lane LOS	-	-	A	A	-
HCM 95th %tile Q(veh)	-	-	-	-	-

Intersection						
Int Delay, s/veh	0.8					
Movement	EBL	EBR	NBL	NBT	SBT	SBR
Lane Configurations						
Traffic Vol, veh/h	10	8	6	134	114	6
Future Vol, veh/h	10	8	6	134	114	6
Conflicting Peds, #/hr	0	0	0	0	0	0
Sign Control	Stop	Stop	Free	Free	Free	Free
RT Channelized	-	None	-	None	-	None
Storage Length	0	-	-	-	-	-
Veh in Median Storage, #	0	-	-	0	0	-
Grade, %	0	-	-	0	0	-
Peak Hour Factor	92	92	92	92	92	92
Heavy Vehicles, %	2	2	2	2	2	2
Mvmt Flow	11	9	7	146	124	7

Major/Minor	Minor2	Major1		Major2	
Conflicting Flow All	288	128	131	0	0
Stage 1	128	-	-	-	-
Stage 2	160	-	-	-	-
Critical Hdwy	6.42	6.22	4.12	-	-
Critical Hdwy Stg 1	5.42	-	-	-	-
Critical Hdwy Stg 2	5.42	-	-	-	-
Follow-up Hdwy	3.518	3.318	2.218	-	-
Pot Cap-1 Maneuver	702	922	1454	-	-
Stage 1	898	-	-	-	-
Stage 2	869	-	-	-	-
Platoon blocked, %				-	-
Mov Cap-1 Maneuver	698	922	1454	-	-
Mov Cap-2 Maneuver	698	-	-	-	-
Stage 1	894	-	-	-	-
Stage 2	869	-	-	-	-

Approach	EB	NB	SB
HCM Control Delay, s	9.7	0.3	0
HCM LOS	A		

Minor Lane/Major Mvmt	NBL	NBT	EBLn1	SBT	SBR
Capacity (veh/h)	1454	-	782	-	-
HCM Lane V/C Ratio	0.004	-	0.025	-	-
HCM Control Delay (s)	7.5	0	9.7	-	-
HCM Lane LOS	A	A	A	-	-
HCM 95th %tile Q(veh)	0	-	0.1	-	-

Queuing Reports



Intersection: 1: Nunbird Ct/Dunlin Dr & Retail Row St

Movement	WB	NB	SB
Directions Served	L	LTR	LTR
Maximum Queue (ft)	23	57	44
Average Queue (ft)	1	25	15
95th Queue (ft)	12	50	40
Link Distance (ft)		143	96
Upstream Blk Time (%)			
Queuing Penalty (veh)			
Storage Bay Dist (ft)	190		
Storage Blk Time (%)			
Queuing Penalty (veh)			

Intersection: 3: Retail Row St & Willet Way

Movement	EB	SB
Directions Served	L	LR
Maximum Queue (ft)	34	47
Average Queue (ft)	3	19
95th Queue (ft)	21	45
Link Distance (ft)		174
Upstream Blk Time (%)		
Queuing Penalty (veh)		
Storage Bay Dist (ft)	120	
Storage Blk Time (%)		
Queuing Penalty (veh)		

Zone Summary

Zone wide Queuing Penalty: 0

Queuing and Blocking Report
AM Peak Hour

2044 Total Traffic
AM Peak Hour

Intersection: 9: US 24 & Woodmen Rd

Movement	EB	EB	EB	WB	WB	WB	NB	NB	NB	NB	NB	NB
Directions Served	L	L	T	L	T	T	L	L	T	T	T	R
Maximum Queue (ft)	195	218	222	103	93	117	231	240	162	192	208	25
Average Queue (ft)	109	128	97	44	45	52	123	147	57	86	104	1
95th Queue (ft)	184	200	176	85	85	93	203	218	135	170	185	11
Link Distance (ft)			643		452	452			2146	2146	2146	
Upstream Blk Time (%)												
Queuing Penalty (veh)												
Storage Bay Dist (ft)	350	350		260			855	855				600
Storage Blk Time (%)												
Queuing Penalty (veh)												

Intersection: 9: US 24 & Woodmen Rd

Movement	B36	B36	SB	SB	SB	SB	SB
Directions Served	T	T	L	T	T	T	R
Maximum Queue (ft)	9	14	116	284	270	246	25
Average Queue (ft)	0	0	39	188	177	143	1
95th Queue (ft)	7	10	83	258	252	229	18
Link Distance (ft)	539	539		1706	1706	1706	
Upstream Blk Time (%)							
Queuing Penalty (veh)							
Storage Bay Dist (ft)			700			375	
Storage Blk Time (%)							
Queuing Penalty (veh)							

Zone Summary

Zone wide Queuing Penalty: 0

Intersection: 1: Nunbird Ct/Dunlin Dr & Retail Row St

Movement	WB	NB	SB
Directions Served	L	LTR	LTR
Maximum Queue (ft)	46	31	87
Average Queue (ft)	13	14	38
95th Queue (ft)	39	39	71
Link Distance (ft)		143	96
Upstream Blk Time (%)			0
Queuing Penalty (veh)			0
Storage Bay Dist (ft)	190		
Storage Blk Time (%)			
Queuing Penalty (veh)			

Intersection: 3: Retail Row St & Willet Way

Movement	EB	SB
Directions Served	L	LR
Maximum Queue (ft)	36	66
Average Queue (ft)	12	35
95th Queue (ft)	37	58
Link Distance (ft)		174
Upstream Blk Time (%)		
Queuing Penalty (veh)		
Storage Bay Dist (ft)	120	
Storage Blk Time (%)		
Queuing Penalty (veh)		

Intersection: 9: US 24 & Woodmen Rd

Movement	EB	EB	EB	B31	WB	WB	WB	NB	NB	NB	NB	NB
Directions Served	L	L	T	T	L	T	T	L	L	T	T	T
Maximum Queue (ft)	328	339	272	4	137	186	196	243	258	443	476	492
Average Queue (ft)	227	243	131	0	51	97	113	112	144	216	261	280
95th Queue (ft)	309	323	218	3	104	156	171	194	229	355	405	415
Link Distance (ft)			643	433		452	452			2146	2146	2146
Upstream Blk Time (%)												
Queuing Penalty (veh)												
Storage Bay Dist (ft)	350	350			260			855	855			
Storage Blk Time (%)	0	0										
Queuing Penalty (veh)	0	0										

Intersection: 9: US 24 & Woodmen Rd

Movement	NB	B36	B36	B36	SB	SB	SB	SB	SB
Directions Served	R	T	T	T	L	T	T	T	R
Maximum Queue (ft)	64	10	11	11	255	392	401	379	95
Average Queue (ft)	7	0	0	0	77	259	250	216	3
95th Queue (ft)	36	8	8	8	171	365	355	325	69
Link Distance (ft)		539	539	539		1706	1706	1706	
Upstream Blk Time (%)									
Queuing Penalty (veh)									
Storage Bay Dist (ft)	600				700				375
Storage Blk Time (%)								1	
Queuing Penalty (veh)								2	

Zone Summary

Zone wide Queuing Penalty: 3

NCHRP Report 684 Internal Trip Capture Estimation Tool



NCHRP 684 Internal Trip Capture Estimation Tool			
Project Name:	The Commons at Falcon Field	Organization:	LSC Transportation Consultants, Inc
Project Location:	El Paso County, CO	Performed By:	KDF
Scenario Description:	Buildout	Date:	3/26/2024
Analysis Year:	2044	Checked By:	
Analysis Period:	AM Street Peak Hour	Date:	

Table 1-A: Base Vehicle-Trip Generation Estimates (Single-Use Site Estimate)						
Land Use	Development Data (For Information Only)			Estimated Vehicle-Trips ³		
	ITE LUCs ¹	Quantity	Units	Total	Entering	Exiting
Office				0		
Retail				145	90	55
Restaurant				0		
Cinema/Entertainment				0		
Residential				119	30	89
Hotel				0		
All Other Land Uses ²				0		
				264	120	144

Table 2-A: Mode Split and Vehicle Occupancy Estimates						
Land Use	Entering Trips			Exiting Trips		
	Veh. Occ. ⁴	% Transit	% Non-Motorized	Veh. Occ. ⁴	% Transit	% Non-Motorized
Office						
Retail						
Restaurant						
Cinema/Entertainment						
Residential						
Hotel						
All Other Land Uses ²						

Table 3-A: Average Land Use Interchange Distances (Feet Walking Distance)						
Origin (From)	Destination (To)					
	Office	Retail	Restaurant	Cinema/Entertainment	Residential	Hotel
Office						
Retail						
Restaurant						
Cinema/Entertainment						
Residential						
Hotel						

Table 4-A: Internal Person-Trip Origin-Destination Matrix*						
Origin (From)	Destination (To)					
	Office	Retail	Restaurant	Cinema/Entertainment	Residential	Hotel
Office		0	0	0	0	0
Retail	0		0	0	1	0
Restaurant	0	0		0	0	0
Cinema/Entertainment	0	0	0		0	0
Residential	0	1	0	0		0
Hotel	0	0	0	0	0	

Table 5-A: Computations Summary			
	Total	Entering	Exiting
All Person-Trips	264	120	144
Internal Capture Percentage	2%	2%	1%
External Vehicle-Trips ⁵	260	118	142
External Transit-Trips ⁶	0	0	0
External Non-Motorized Trips ⁶	0	0	0

Table 6-A: Internal Trip Capture Percentages by Land Use		
Land Use	Entering Trips	Exiting Trips
Office	N/A	N/A
Retail	1%	2%
Restaurant	N/A	N/A
Cinema/Entertainment	N/A	N/A
Residential	3%	1%
Hotel	N/A	N/A

¹Land Use Codes (LUCs) from *Trip Generation Manual*, published by the Institute of Transportation Engineers.

²Total estimate for all other land uses at mixed-use development site is not subject to internal trip capture computations in this estimator.

³Enter trips assuming no transit or non-motorized trips (as assumed in ITE *Trip Generation Manual*).

⁴Enter vehicle occupancy assumed in Table 1-A vehicle trips. If vehicle occupancy changes for proposed mixed-use project, manual adjustments must be made to Tables 5-A, 9-A (O and D). Enter transit, non-motorized percentages that will result with proposed mixed-use project complete.

⁵Vehicle-trips computed using the mode split and vehicle occupancy values provided in Table 2-A.

⁶Person-Trips

*Indicates computation that has been rounded to the nearest whole number.

Estimation Tool Developed by the Texas A&M Transportation Institute - Version 2013.1

Project Name:	The Commons at Falcon Field
Analysis Period:	AM Street Peak Hour

Land Use	Table 7-A (D): Entering Trips			Table 7-A (O): Exiting Trips		
	Veh. Occ.	Vehicle-Trips	Person-Trips*	Veh. Occ.	Vehicle-Trips	Person-Trips*
Office	1.00	0	0	1.00	0	0
Retail	1.00	90	90	1.00	55	55
Restaurant	1.00	0	0	1.00	0	0
Cinema/Entertainment	1.00	0	0	1.00	0	0
Residential	1.00	30	30	1.00	89	89
Hotel	1.00	0	0	1.00	0	0

Origin (From)	Destination (To)					
	Office	Retail	Restaurant	Cinema/Entertainment	Residential	Hotel
Office		0	0	0	0	0
Retail	16		7	0	8	0
Restaurant	0	0		0	0	0
Cinema/Entertainment	0	0	0		0	0
Residential	2	1	18	0		0
Hotel	0	0	0	0	0	

Origin (From)	Destination (To)					
	Office	Retail	Restaurant	Cinema/Entertainment	Residential	Hotel
Office		29	0	0	0	0
Retail	0		0	0	1	0
Restaurant	0	7		0	2	0
Cinema/Entertainment	0	0	0		0	0
Residential	0	15	0	0		0
Hotel	0	4	0	0	0	

Destination Land Use	Person-Trip Estimates			External Trips by Mode*		
	Internal	External	Total	Vehicles ¹	Transit ²	Non-Motorized ²
Office	0	0	0	0	0	0
Retail	1	89	90	89	0	0
Restaurant	0	0	0	0	0	0
Cinema/Entertainment	0	0	0	0	0	0
Residential	1	29	30	29	0	0
Hotel	0	0	0	0	0	0
All Other Land Uses ³	0	0	0	0	0	0

Origin Land Use	Person-Trip Estimates			External Trips by Mode*		
	Internal	External	Total	Vehicles ¹	Transit ²	Non-Motorized ²
Office	0	0	0	0	0	0
Retail	1	54	55	54	0	0
Restaurant	0	0	0	0	0	0
Cinema/Entertainment	0	0	0	0	0	0
Residential	1	88	89	88	0	0
Hotel	0	0	0	0	0	0
All Other Land Uses ³	0	0	0	0	0	0

¹Vehicle-trips computed using the mode split and vehicle occupancy values provided in Table 2-A
²Person-Trips
³Total estimate for all other land uses at mixed-use development site is not subject to internal trip capture computations in this estimator
*Indicates computation that has been rounded to the nearest whole number.

NCHRP 684 Internal Trip Capture Estimation Tool			
Project Name:	The Commons at Falcon Field	Organization:	LSC Transportation Consultants, Inc
Project Location:	El Paso County, CO	Performed By:	KDF
Scenario Description:	Buildout	Date:	3/26/2024
Analysis Year:	2044	Checked By:	
Analysis Period:	PM Street Peak Hour	Date:	

Table 1-P: Base Vehicle-Trip Generation Estimates (Single-Use Site Estimate)						
Land Use	Development Data (For Information Only)			Estimated Vehicle-Trips ³		
	ITE LUCs ¹	Quantity	Units	Total	Entering	Exiting
Office				0		
Retail				436	214	222
Restaurant				0		
Cinema/Entertainment				0		
Residential				160	101	59
Hotel				0		
All Other Land Uses ²				0		
				596	315	281

Table 2-P: Mode Split and Vehicle Occupancy Estimates						
Land Use	Entering Trips			Exiting Trips		
	Veh. Occ. ⁴	% Transit	% Non-Motorized	Veh. Occ. ⁴	% Transit	% Non-Motorized
Office						
Retail						
Restaurant						
Cinema/Entertainment						
Residential						
Hotel						
All Other Land Uses ²						

Table 3-P: Average Land Use Interchange Distances (Feet Walking Distance)						
Origin (From)	Destination (To)					
	Office	Retail	Restaurant	Cinema/Entertainment	Residential	Hotel
Office						
Retail					5280	
Restaurant						
Cinema/Entertainment						
Residential						
Hotel						

Table 4-P: Internal Person-Trip Origin-Destination Matrix*						
Origin (From)	Destination (To)					
	Office	Retail	Restaurant	Cinema/Entertainment	Residential	Hotel
Office		0	0	0	0	0
Retail	0		0	0	6	0
Restaurant	0	0		0	0	0
Cinema/Entertainment	0	0	0		0	0
Residential	0	21	0	0		0
Hotel	0	0	0	0	0	

Table 5-P: Computations Summary			
	Total	Entering	Exiting
All Person-Trips	596	315	281
Internal Capture Percentage	9%	9%	10%
External Vehicle-Trips ⁵	542	288	254
External Transit-Trips ⁶	0	0	0
External Non-Motorized Trips ⁶	0	0	0

Table 6-P: Internal Trip Capture Percentages by Land Use		
Land Use	Entering Trips	Exiting Trips
Office	N/A	N/A
Retail	10%	3%
Restaurant	N/A	N/A
Cinema/Entertainment	N/A	N/A
Residential	6%	36%
Hotel	N/A	N/A

¹Land Use Codes (LUCs) from *Trip Generation Manual*, published by the Institute of Transportation Engineers.

²Total estimate for all other land uses at mixed-use development site is not subject to internal trip capture computations in this estimator.

³Enter trips assuming no transit or non-motorized trips (as assumed in ITE *Trip Generation Manual*).

⁴Enter vehicle occupancy assumed in Table 1-P vehicle trips. If vehicle occupancy changes for proposed mixed-use project, manual adjustments must be made.

⁵Vehicle-trips computed using the mode split and vehicle occupancy values provided in Table 2-P.

⁶Person-Trips

*Indicates computation that has been rounded to the nearest whole number.

Project Name:	The Commons at Falcon Field
Analysis Period:	PM Street Peak Hour

Table 7-P: Conversion of Vehicle-Trip Ends to Person-Trip Ends						
Land Use	Table 7-P (D): Entering Trips			Table 7-P (O): Exiting Trips		
	Veh. Occ.	Vehicle-Trips	Person-Trips*	Veh. Occ.	Vehicle-Trips	Person-Trips*
Office	1.00	0	0	1.00	0	0
Retail	1.00	214	214	1.00	222	222
Restaurant	1.00	0	0	1.00	0	0
Cinema/Entertainment	1.00	0	0	1.00	0	0
Residential	1.00	101	101	1.00	59	59
Hotel	1.00	0	0	1.00	0	0

Table 8-P (O): Internal Person-Trip Origin-Destination Matrix (Computed at Origin)						
Origin (From)	Destination (To)					
	Office	Retail	Restaurant	Cinema/Entertainment	Residential	Hotel
Office		0	0	0	0	0
Retail	4		64	9	6	11
Restaurant	0	0		0	0	0
Cinema/Entertainment	0	0	0		0	0
Residential	2	25	12	0		2
Hotel	0	0	0	0	0	

Table 8-P (D): Internal Person-Trip Origin-Destination Matrix (Computed at Destination)						
Origin (From)	Destination (To)					
	Office	Retail	Restaurant	Cinema/Entertainment	Residential	Hotel
Office		17	0	0	4	0
Retail	0		0	0	46	0
Restaurant	0	107		0	16	0
Cinema/Entertainment	0	9	0		4	0
Residential	0	21	0	0		0
Hotel	0	4	0	0	0	

Table 9-P (D): Internal and External Trips Summary (Entering Trips)						
Destination Land Use	Person-Trip Estimates			External Trips by Mode*		
	Internal	External	Total	Vehicles ¹	Transit ²	Non-Motorized ²
Office	0	0	0	0	0	0
Retail	21	193	214	193	0	0
Restaurant	0	0	0	0	0	0
Cinema/Entertainment	0	0	0	0	0	0
Residential	6	95	101	95	0	0
Hotel	0	0	0	0	0	0
All Other Land Uses ³	0	0	0	0	0	0

Table 9-P (O): Internal and External Trips Summary (Exiting Trips)						
Origin Land Use	Person-Trip Estimates			External Trips by Mode*		
	Internal	External	Total	Vehicles ¹	Transit ²	Non-Motorized ²
Office	0	0	0	0	0	0
Retail	6	216	222	216	0	0
Restaurant	0	0	0	0	0	0
Cinema/Entertainment	0	0	0	0	0	0
Residential	21	38	59	38	0	0
Hotel	0	0	0	0	0	0
All Other Land Uses ³	0	0	0	0	0	0

¹Vehicle-trips computed using the mode split and vehicle occupancy values provided in Table 2-P

²Person-Trips

³Total estimate for all other land uses at mixed-use development site is not subject to internal trip capture computations in this estimator

*Indicates computation that has been rounded to the nearest whole number.