

**WIDEFIELD WATER AND
SANITATION DISTRICT**

2 MG ROLLING HILLS TANK

**SITE DEVELOPMENT PLAN
DRAINAGE LETTER**

August 2020

Please revise to
final drainage report



JDS Project Number 102.121

Prepared By:



CONSULTANTS, INC.

Design Engineer's Statement:

The attached drainage plan and report were prepared under my direction and supervision and are correct to the best of my knowledge and belief. Said drainage report has been prepared according to the criteria established by the County for drainage reports and said report is in conformity with the applicable master plan of the drainage basin. I accept responsibility for any liability caused by any negligent acts, errors or omissions on my part in preparing this report.

Elizabeth Steffens, PE #53332

Date

Owner/Developer's Statement:

I, the owner/developer have read and will comply with all of the requirements specified in this drainage report and plan.

Lucas Hale
Widefield Water and Sanitation District
8495 Fontaine Blvd., Colorado Springs, CO 80925

Date

El Paso County:

Filed in accordance with the requirements of the Drainage Criteria Manual, Volumes 1 and 2, El Paso County Engineering Criteria Manual and Land Development Code as amended.

Jennifer Irvine, P.E.
County Engineer / ECM Administrator

Date

Conditions:

**El Paso County
Planning & Community Development**
2880 International Circle, Suite 110
Colorado Springs, CO 80910-3127
Attn: Gabe Sevigny

August 19, 2020

**RE: Widefield Water and Sanitation District
2 MG Potable Water Tank
1041 Submittal – Drainage Letter
Address: TBD (Schedule 5500000385)**

Dear Mr. Sevigny:

The purpose of this drainage letter is to satisfy requirements of the El Paso County Planning and Community Development division pertaining to the proposed 1041 Submittal for the project referenced above.

Property Description:

The intention of the applicant is to construct a storage tank to provide water service to areas within the existing Widefield Water and Sanitation District (WWSO) service area boundaries.

The site for Rolling Hills 2MG Tank is located in the Northwest 1/4 of Section 1, Township 15 South, Range 65 West of the 6th Principle Meridian, El Paso County, Colorado (El Paso County Parcel #: 5500000385). The subject facility is a proposed potable water tank and will be located on a 3.472 acre proposed site within the 802.42-acre overall parcel.

Figure 1 – Jimmy Camp Creek Drainage Basins

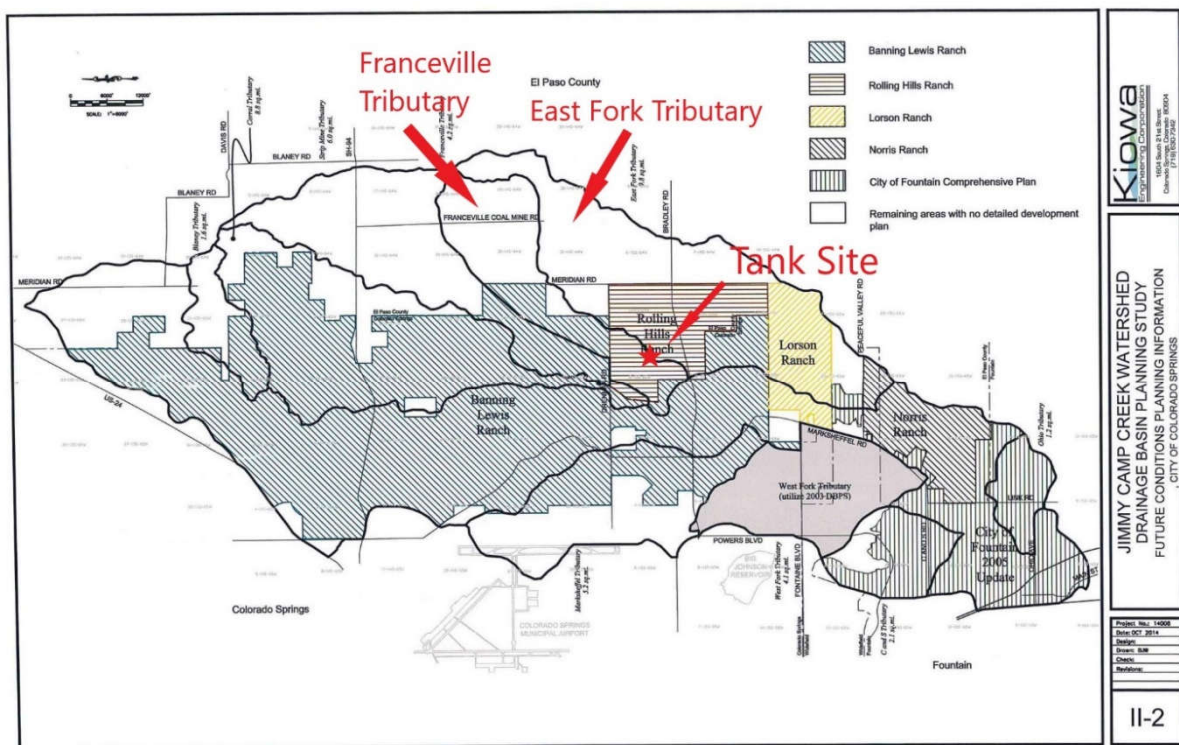

This project is located in the Jimmy Camp Creek Drainage Basin (FOFO2000) with Jimmy Camp Creek being the receiving water shed. A Drainage Basin Planning Study (DBPS) was prepared for this basin in 2015 by Kiowa Engineering Corporation. This study was authorized by the City of Colorado Springs, but due to the extensive regional implications of the study, input and review to the technical scope of the project was provided by the City of Fountain and El Paso County.

Figure 2 – Jimmy Camp Creek Tributaries

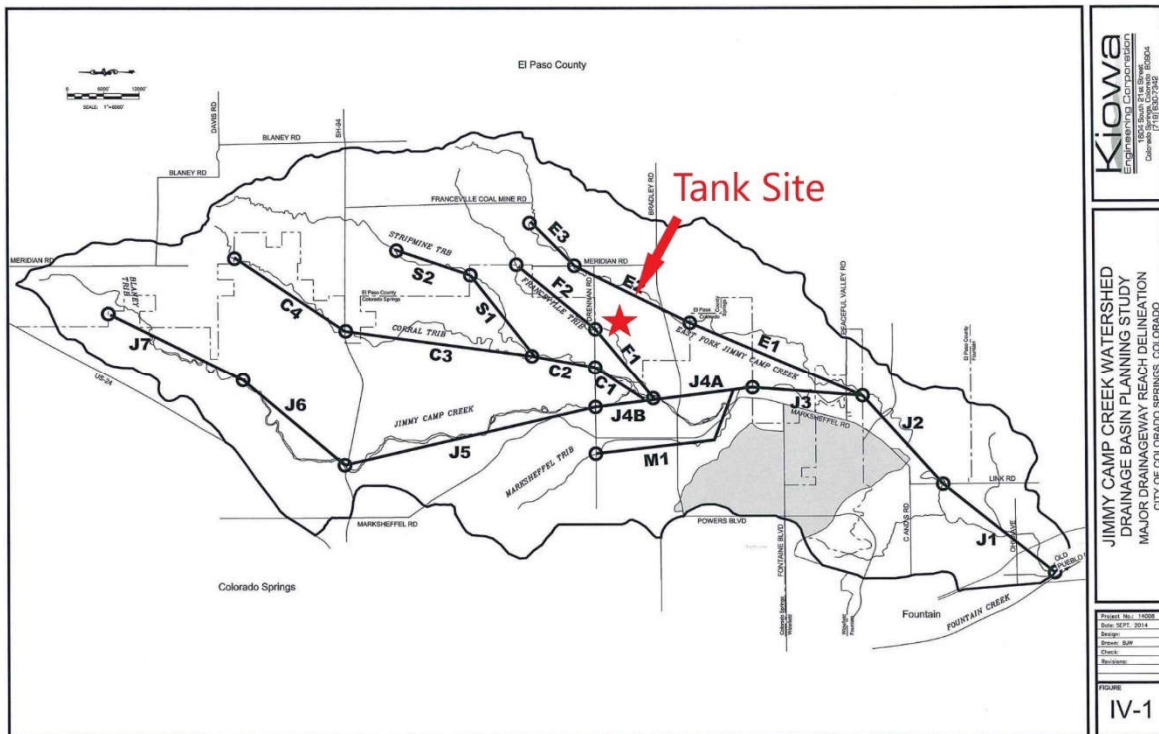

The site borders Drennan Road to the north and South Meridian Road to the east. The site for this project is used as grazing land for cattle and does not have an address. The address for the new facility will be determined and granted by the Pikes Peak Regional Building Department during their review of the building permit.

Soils

Soils for this project are delineated as Tassel fine sandy loam, 3 to 18 percent slopes (89) and are characterized as Hydrologic Soil Group D (high runoff potential when thoroughly wet). Soils were mapped using the NRCS Web Soil Survey. According to a geotechnical evaluation report by Vivid Engineering Group, dated 3/5/2020, site soils were comprised predominately of Piney Creek Alluvium deposits of mostly clayey and silty sand underlain by interbedded sandstone, claystone, and shale bedrock of the Pierre Shale Formation. A total of seven (7) exploratory borings within or near the general area to be occupied by the proposed tank were drilled to depths ranging from approximately 29 to 45 feet below the existing ground surface. The ground surface consists of gently rolling topography and was covered predominantly with grasses and yucca plants. A copy of NRCS Web Soil Survey is included in Appendix A.

Please also identify that there is a FEMA floodplain zone AE on the parcel to east of the site. I suggest also providing an approximate distance from the development to the boundary of the floodplain.

Flood Plain Statement

The Floodplain Insurance Rate Map (FIRM) for El Paso County (map number 08041C0790G, dated December 7, 2018) was reviewed to determine any potential floodplain delineation. A copy of the relevant portion of this FIRM panel can be found in Appendix B. As shown, the proposed site lies within Zone X, defined as areas outside the 100-year floodplain.

Drainage Criteria

This drainage analysis has been prepared in accordance with the current El Paso County Drainage Criteria Manual (Volumes 1 and 2). Volume 1 was established in 1991 with subsequent revisions in 1994. In 2002, the City of Colorado Springs Drainage Criteria Manual Volume 2 (DCMV2) was adopted as El Paso County’s stormwater quality design criteria with Appendix H of the El Paso County’s Engineering Criteria manual (ECM) to provide additions and revisions applicable to the County. In 2015, El Paso County adopted portions of the City of Colorado Springs Drainage Criteria Manual Volume 1 dated May 2014 including Chapter 6 and Section 3.2.1 of Chapter 13. In addition, the Urban Storm Drainage Criteria Manuals, Volumes 1-3 published by the Mile High Flood District (MHFD), formerly known as the Urban Drainage and Flood Control District, and dated November 2010 with subsequent updates were used to prepare this drainage report.

The Site is located within the Jimmy Camp Creek Drainage Basin (FOFO2000) with Jimmy Camp Creek being the receiving water shed. A Drainage Basin Planning Study (DBPS) was prepared for this basin in 2015 by Kiowa Engineering Corporation. A Master Development Drainage Plan for the Rolling Hills Ranch development will be prepared in the future. The proposed water storage tank will serve the future Rolling Hills Ranch development and will be owned and operated by WWSD.

Four Step Process

The Four Step Process for stormwater quality management listed below was utilized during planning for the proposed water tank site when applicable. Further details on how this was implemented for the proposed project is discussed throughout this drainage report.

Step 1: Employ Runoff Reduction Practices

Gravel driveway rather than a paved driveway is planned. Reduces runoff by disconnecting impervious area, eliminating “unnecessary” impervious area and encouraging infiltration into soils that are suitable.

Step 2: Stabilize Drainageways.

By implementing a sand filter basin the runoff from the water tank site will be reduced to pre-development conditions and therefore not anticipated to have negative effects on downstream drainageways.

Please also state whether or not there are any drainageways within the development that need stabilization

Step 3: Provide Water Quality Capture Volume (WQCV).

Sand filter basin is proposed to encourage infiltration of the WQCV.

Step 4: Consider Need for Industrial and Commercial BMPs

Spill containment and control for equipment fueling and maintenance and bulk storage will be implemented on the site. In addition, silt fence, sediment control logs, vehicle tracking control pad, concrete washout area, and mulching and reseeding will be used to mitigate the potential for erosion on the site. Further details will be provided in the site's stormwater management plan (SWMP).

Hydrologic Calculations

The hydrologic calculations were prepared following guidance from El Paso County Drainage Criteria Manual and resources from the MHFD (formerly known as UDFCD). The tank and access road easements are less than 100 acres, so the Rational Method is utilized as recommended in El Paso County Drainage Criteria Manual Volume 1. The Rational Method was used to determine estimated runoff peak discharges from storms between 2-year and 100-year storm recurrence intervals. Figure 6-5 IDF Curves are based on the rainfall depths for an elevation of 6,840 feet in the Colorado Springs area and were used for the hydrologic calculations. The 1-hr rainfall depths for each storm recurrence interval were obtained from the NOAA Atlas 14 Volume 8 Version 2 on the NOAA website.

Table 1 – 1-hr Rainfall Depths

1-hr rainfall depth, P1 (in)						
2-yr	5-yr	10-yr	25-yr	50-yr	100-yr	500-yr
0.69	0.98	1.23	1.58	1.86	2.14	2.84

Runoff coefficients were established based on Table 6-6 and Equation 6-6 of the El Paso County Drainage Criteria Manual Volume 1 Update. The percent impervious values for the site was calculated using the existing conditions for pre-development and proposed improvements for post-development. Time of concentration (Tc) for the basin for both historic and developed flows was calculated using Equations 6-7 through 6-9 of the El Paso County Drainage Criteria Manual Volume 1 Update. The El Paso Drainage Criteria Manual recommends limiting overland flow to a maximum of 300 feet in non-urban land uses. Calculations can be found in Appendix C.

Hydraulic Calculations

Hydraulic calculations were estimated using methods described in the El Paso County Drainage Criteria Manual and resources from the MHFD.

Drainage swale hydraulic calculations were performed using Manning's Equation to determine the drainage swale geometry needed to convey the developed runoff based on the site conditions. Calculations can be found in Appendix C.

Access to the tank site is provided from Drennan Rd. The proposed culvert is located near a high point and will convey flows from an approximately 1.1-acre area which includes 350 feet of gravel driveway and grassed drainage swale adjacent to the access road. Hydraulic calculations for the proposed culvert were prepared using HY-8. Based on the calculations and the City of Colorado Springs minimum culvert size requirement, a 15-inch CMP culvert is proposed for the temporary access road. Culvert calculations are provided in Appendix E.

Further discussion of the hydraulic calculations for the sand filter basin outlet works is included in the Sand Filter Basin section.

Existing Drainage Conditions

The developed land for the potable water tank will occur on the 3.472 acre easement, located at the high point of the surrounding area and is not impacted from off-site flows. An access road from Drennan Rd. will serve the tank site. Historically, Subbasin A drains to the west and enters Franceville Tributary either by entering the roadside ditch along Drennan Road and flowing west or by overland flow. Subbasin B drains to the southeast and enters the Jimmy Camp East Tributary. The site is covered with native vegetation and includes grass and herbaceous species typical of vegetative assemblages in pastures routinely grazed by livestock. There are no existing drainage facilities (storm pipes, inlets, culverts, etc.) on the site.

The site evaluated for this study includes the 3.472 acre easement for the tank site and 1.09 acre easement for the access road. The drainage is subdivided into two basins (Subbasin A and B) for this evaluation. Drainage basin delineation is included in Appendix F.

Please be aware that per criteria the minor and major storms are the 5yr and 100yr. You may revise the calculations to the 5yr storm if you so choose.

Subbasin A

Runoff is conveyed via overland sheet flow at a slope of 4.9% resulting in a time of concentration (Tc) of 12.18 minutes to the northwest to a point identified as Design Point DP-EX-A. Table 2 – Pre-Development Runoff for Subbasin A provides the calculated runoff flows for the pre-development condition.

Table 2 – Pre-Development Runoff for Subbasin A

	10-year	100-year
Peak Flow, cfs	2.10	6.05

Subbasin B

Runoff is conveyed via overland sheet flow at a slope of 9.7% resulting in a time of concentration (Tc) of 10.57 minutes to the southeast to a point identified as Design Point DP-EX-B. Table 3 – Pre-Development Runoff for Subbasin B provides the calculated runoff flows for the pre-development condition.

Table 3 – Pre-Development Runoff for Subbasin B

	10-year	100-year
Peak Flow, cfs	1.26	3.63

Proposed Drainage Conditions

General Concept

Proposed drainage will generally remain the same as the existing drainage. The addition of the water tank will add 7,620 square feet of new impervious area based on the roof of the tank. The gravel access road up to the tank and 15 ft clear area around the tank will add 30,700 square feet.

The proposed drainage for the tank site has been divided into three subbasins (Subbasins A, B, & C). Subbasin A is generally unchanged and flows off-site via sheet flow to the west and into the Franceville Tributary drainage basin. Subbasin B is generally unchanged and flows off-site via sheet flow to the southeast and into the East Fork Tributary. Subbasin C (historically included in Subbasin A & B) is a new small subbasin and includes the tank access road and drainage swale, tank roof, and 15 ft gravel area around the tank. Flow from Subbasin C is discharged into the East Fork Tributary. Drainage in Subbasin C will be conveyed via drainage swale around the tank and continues in a vegetated drainage swale adjacent to the access road to a sand filter basin (SFB) located at a natural low point before discharging off-site and into the East Fork Tributary drainage basin. The proposed SFB will treat additional drainage

produced from impervious areas that will be added to the site as a result of the tank construction including the tank roof and gravel areas. The SFB provides full spectrum detention and will be used to treat the Water Quality Capture Volume (WQCV) and detain the 100-yr flood event to pre-development release rates before leaving the site. The SFB is based on a drain time of 12 hours for the WQCV and 10-yr and 100-year release rate based on draining at 90% of predevelopment flows. Note that Colorado law requires 97% of the 5-year storm event to drain within 72 hours.

The SFB is included in the access road easement and language was included in the easement that the structure may only be abandoned when the future Rolling Hills Ranch Development agrees to accept and treat the developed runoff from the site. Subbasins A will generally not be changed and will drain into the undisturbed existing area to the northwest. Subbasin B will generally not be changed and will drain into the undisturbed existing area to the southeast. The natural division of drainage between Subbasin A and B will be shifted east to allow portions of the land previously included in Subbasin B to drain into the detention area created in Subbasin A.

C? that is where the SFB is.

Approximately 350 LF of the access road drains to the northwest and into the Drennan Rd. drainage ditch. The access road location was driven by grade restraints at the intersection of Drennan Rd and to limit excavation in the exposed sandstone. The drainage area for the access road culvert was designated Subbasin D.

Developed drainage basin delineation is included in Appendix F.

Specific Design Details

Subbasin A & B

Subbasin A & B result in a reduction in post-development runoff due to the reduced size of the drainage area. Developed flows from Subbasin A & B are presented in Table 4 – Post-Development Runoff Estimates for Subbasin A & B below.

Table 4 – Post-Development Runoff for Subbasin A & B

	10-year	100-year
<i>Subbasin A</i>		
Peak Flow, cfs	1.62	3.63
	30% Decrease	
<i>Subbasin B</i>		
Peak Flow, cfs	1.04	3.63
	22% Decrease	

Subbasin C

Subbasin C is a new subbasin created due to the site improvements and was previously included within pre-development Subbasin A & B. Subbasin C is 1.76 acres and includes the access road easement and tank site easement. Subbasin C is located at a high point and is not impacted from off-site flows. Developed runoff is routed in drainage swales around the tank to a drainage swale located adjacent to the access road and into the proposed SFB at a natural low-point on the access road alignment. Drainage from the access road on the west side of the SFB is also conveyed in a drainage swale to the proposed SFB.

The calculated Tc is 14.66 minutes. Proposed developed flows are greater than pre-development flows due to the additional impervious area for the new gravel access road and water storage tank.

Subbasin C generates the developed flow presented in Table 5 – Post-Development Runoff Estimates for Subbasin C below.

Table 5 - Post-Development Runoff Estimates for Subbasin C

	10-yr	100-yr
Post-Development, cfs	3.19	6.43

Please add to the table the flows after being detained (release rate) in the SFB.

Subbasin D

Subbasin D is a new subbasin created due to the proposed site access road. Drainage from this subbasin flows to the access road culvert at the intersection of Drennan Rd. Flow from the culvert is conveyed west in the Drennan Rd. drainage ditch and contributes to the Franceville Tributary of Jimmy Camp Creek.

The calculated Tc is 14.77 minutes. Proposed developed flows are greater than pre-development flows due to the additional impervious area for the new gravel access road. Subbasin D generates the developed flow presented in Table 6 – Post-Development Runoff Estimates for Subbasin D below.

Table 6 - Post-Development Runoff Estimates for Subbasin D

	10-yr	100-yr
Post-Development, cfs	1.40	3.49

Sand Filter Basin (SFB)

The SFB provides an 18-inch layer of filter material with an underdrain system that discharges into the proposed outlet structure. The SFB will allow for partial infiltration and the stormwater that does not infiltrate is collected and removed by the underdrain system. An orifice plate on the underdrain pipe is sized to drain the design volume in approximately 12 hours or more. The proposed outlet structure is comprised of a sloped inlet concrete box with circular orifice and overflow weir including an outlet pipe with circular orifice plate designed to constrict flow to no more than 90% of the pre-development release rate for the 100-yr event. The underdrain pipe with orifice plate discharges into the outlet structure. A 15-inch RCP outlet pipe discharges flows off-site and into the East Fork Tributary.

The SFB proposed for the site includes volumes, release rates, and components matching the design guidelines in the EPC DCM (Volumes I and II) and the ECM as well as guidance from USDCM. Due to the very small size of the drainage basin, a time step interval of 1-minute was used for the inflow hydrograph to more accurately represent the incoming flow. This resulted in different stage and volume calculations for each zone than what was calculated using the simplified equations. Below is a list of the SFB’s major characteristics:

<i>Description (Zone)</i>	<i>Depth</i>	<i>Volume</i>	<i>Release Rate</i>
WQCV	0.10 ft	0.003 acre-ft	0.004 cfs
EURV	0.27 ft	0.010 acre-ft	0.025 cfs
10-yr	0.33 ft	0.013 acre-ft	0.100 cfs
100-yr	0.57 ft	0.024 acre-ft	0.750 cfs

An emergency spillway with a crest length of 1 foot, 4:1 sideslopes, and minimum of 1-foot freeboard above the water surface when the emergency spillway is conveying the maximum design flow. Refer to the detention basin outlet structure design calculations in Appendix D for the outlet structure and spillway design.

A riprap basin is provided where the drainage swale discharges into the sand filter basin for energy dissipation and filtration. Construction details are provided in the drainage plans in Appendix F.

Water Quality Provisions and Maintenance

The proposed SFB provides water quality treatment for runoff produced on the Rolling Hills Tank Site. This water quality basin is designed to treat approximately 1.76 acres and provide 2,044 cubic feet of water quality storage (below the emergency spillway invert). The SFB will be private and maintained by the property owner. Access to be granted to the owner and El Paso County for access and maintenance of the private WOCV facility. A private maintenance agreement accompanies the submittal. The WOCV facility sizing calculations are included as an attachment of this report.

An access road on the north side of the SFB will provide maintenance access to the filter. Cleanouts will be installed on the underdrain pipes to provide access for inspection (by camera) immediately following construction to ensure that the underdrain pipe was not crushed during construction and to provide ongoing maintenance.

Erosion Control

A Grading, Erosion, and Sedimentation Control Plan was prepared in the preliminary design phase and submitted to I-10. Application for the Rolling Hills Tank Site.

Per ECM Appendix I.7.1.C.1 100% of the applicable development site must be captured. Basin D is not captured by the proposed SFB. The above criteria does allow that 20% to exceed 1 acre may be excluded if it is not practicable to capture the runoff. It appears that basin D may qualify for this exclusion. Please be sure to discuss this in your narrative.

Environmental Evaluations:

The project area, which encompasses the proposed tank site, waterline easement, and access road easement, was investigated by a qualified biologist on June 2, 2020 for the purpose of delineating all waterbodies and wetlands and identifying suitable habitat for federally listed threatened and endangered species.

No waters or wetlands were observed within the project area. Two shallow swales were observed but do not exhibit Ordinary High Water Marks (OHWM).

Drainage Fees

No significant drainage structures are planned for this project and therefore no reimbursement will be requested for additional development that occurs within the area of the study. It is anticipated that in the future, the area around the tank will be developed and at that time, a detailed drainage plan and associated infrastructure will be developed. If development occurs around the tank site, the drainage from the tank site will be redirected to storm sewers planned as part of the Rolling Hills Ranch development.

This site is within the Jimmy Camp Creek Drainage Basin. The El Paso County Drainage Basin Fees associated with the site will be paid when the developer plats the land.

Summary

Recommendations are made within this report concerning necessary improvements that will be required as a result of development of this property. The Rolling Hills Tank site is proposing to construct a sand filter basin that will detain developed flows and release at or below historic rates for the 10-yr and 100-yr storm events, as well as provide WQCV treatment. The sand filter basin will sufficiently mitigate the developed flows. The development of the proposed site does not significantly impact any downstream facility or property to an extent greater than that which currently exists due to historic conditions. Overall, proposed drainage characteristics will generally remain the same as existing, with the addition of a sand filter basin to address the developed flow from the site improvements and a driveway culvert along the Drennan Rd. drainage ditch to facilitate access to the site.

Respectfully,
JDS-Hydro Consultants, Inc.



Elizabeth Steffens, P.E.

Enclosed

- Appendix A – Soils Map and Report*
- Appendix B – FIRM Map*
- Appendix C – Hydrologic Calculations*
- Appendix D – Sand Filter Basin/Grass Swale Sizing Calculations*
- Appendix E – Driveway Culvert Sizing Calculations*
- Appendix F – Drainage Plans*

Appendix A

Custom Soil Resource Report for El Paso County Area, Colorado

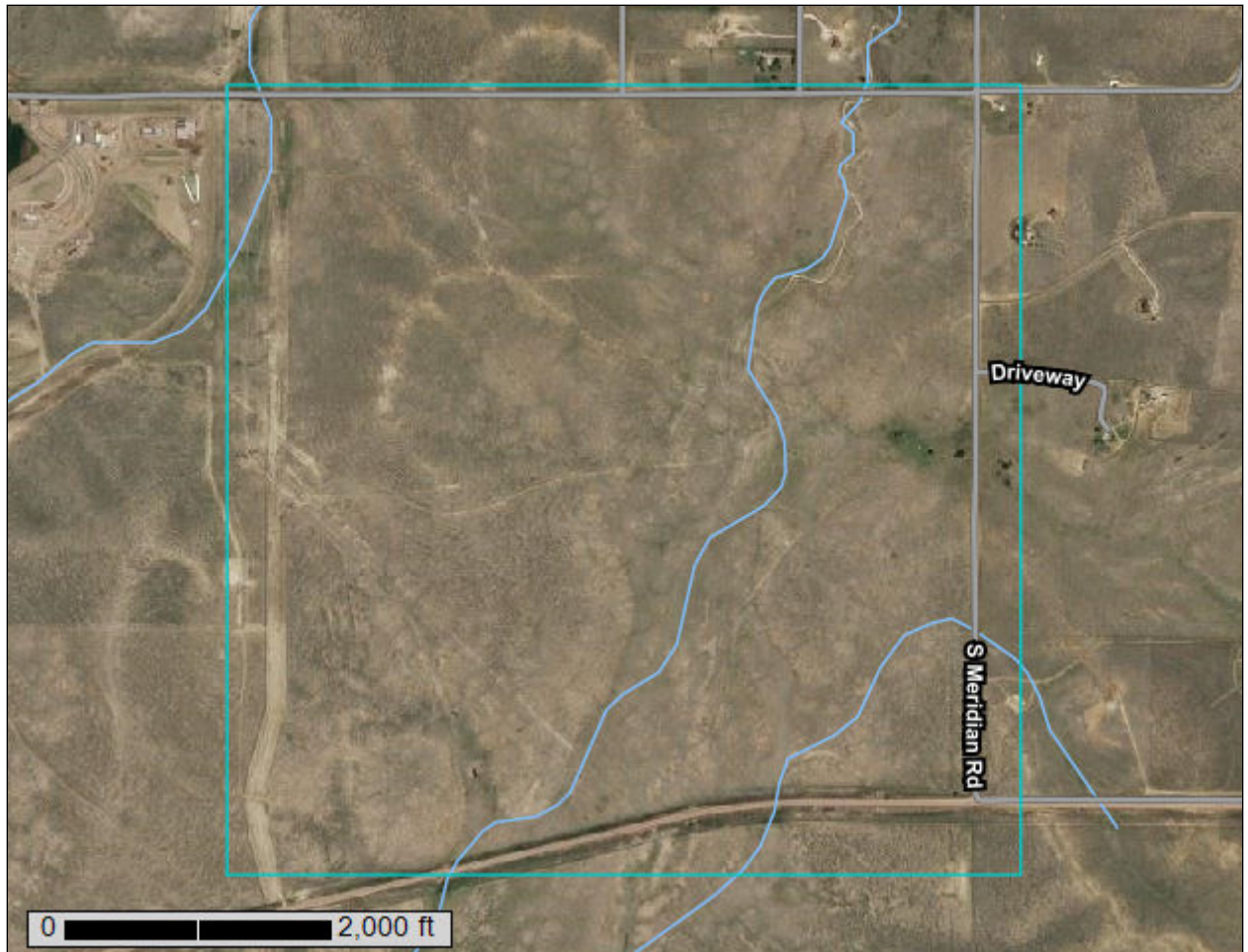

Preface

Soil surveys contain information that affects land use planning in survey areas. They highlight soil limitations that affect various land uses and provide information about the properties of the soils in the survey areas. Soil surveys are designed for many different users, including farmers, ranchers, foresters, agronomists, urban planners, community officials, engineers, developers, builders, and home buyers. Also, conservationists, teachers, students, and specialists in recreation, waste disposal, and pollution control can use the surveys to help them understand, protect, or enhance the environment.

Various land use regulations of Federal, State, and local governments may impose special restrictions on land use or land treatment. Soil surveys identify soil properties that are used in making various land use or land treatment decisions. The information is intended to help the land users identify and reduce the effects of soil limitations on various land uses. The landowner or user is responsible for identifying and complying with existing laws and regulations.

Although soil survey information can be used for general farm, local, and wider area planning, onsite investigation is needed to supplement this information in some cases. Examples include soil quality assessments (<http://www.nrcs.usda.gov/wps/portal/nrcs/main/soils/health/>) and certain conservation and engineering applications. For more detailed information, contact your local USDA Service Center (<https://offices.sc.egov.usda.gov/locator/app?agency=nrcs>) or your NRCS State Soil Scientist (http://www.nrcs.usda.gov/wps/portal/nrcs/detail/soils/contactus/?cid=nrcs142p2_053951).

Great differences in soil properties can occur within short distances. Some soils are seasonally wet or subject to flooding. Some are too unstable to be used as a foundation for buildings or roads. Clayey or wet soils are poorly suited to use as septic tank absorption fields. A high water table makes a soil poorly suited to basements or underground installations.

The National Cooperative Soil Survey is a joint effort of the United States Department of Agriculture and other Federal agencies, State agencies including the Agricultural Experiment Stations, and local agencies. The Natural Resources Conservation Service (NRCS) has leadership for the Federal part of the National Cooperative Soil Survey.

Information about soils is updated periodically. Updated information is available through the NRCS Web Soil Survey, the site for official soil survey information.

The U.S. Department of Agriculture (USDA) prohibits discrimination in all its programs and activities on the basis of race, color, national origin, age, disability, and where applicable, sex, marital status, familial status, parental status, religion, sexual orientation, genetic information, political beliefs, reprisal, or because all or a part of an individual's income is derived from any public assistance program. (Not all prohibited bases apply to all programs.) Persons with disabilities who require

alternative means for communication of program information (Braille, large print, audiotape, etc.) should contact USDA's TARGET Center at (202) 720-2600 (voice and TDD). To file a complaint of discrimination, write to USDA, Director, Office of Civil Rights, 1400 Independence Avenue, S.W., Washington, D.C. 20250-9410 or call (800) 795-3272 (voice) or (202) 720-6382 (TDD). USDA is an equal opportunity provider and employer.

Contents

Preface	2
How Soil Surveys Are Made	5
Soil Map	8
Soil Map (ROLLING HILLS TANK).....	9
Legend.....	10
Map Unit Legend (ROLLING HILLS TANK).....	11
Map Unit Descriptions (ROLLING HILLS TANK).....	11
El Paso County Area, Colorado.....	13
2—Ascalon sandy loam, 1 to 3 percent slopes.....	13
28—Ellicott loamy coarse sand, 0 to 5 percent slopes.....	14
52—Manzanst clay loam, 0 to 3 percent slopes.....	15
56—Nelson-Tassel fine sandy loams, 3 to 18 percent slopes.....	17
78—Sampson loam, 0 to 3 percent slopes.....	19
89—Tassel fine sandy loam, 3 to 18 percent slopes.....	20
108—Wiley silt loam, 3 to 9 percent slopes.....	21
References	23

How Soil Surveys Are Made

Soil surveys are made to provide information about the soils and miscellaneous areas in a specific area. They include a description of the soils and miscellaneous areas and their location on the landscape and tables that show soil properties and limitations affecting various uses. Soil scientists observed the steepness, length, and shape of the slopes; the general pattern of drainage; the kinds of crops and native plants; and the kinds of bedrock. They observed and described many soil profiles. A soil profile is the sequence of natural layers, or horizons, in a soil. The profile extends from the surface down into the unconsolidated material in which the soil formed or from the surface down to bedrock. The unconsolidated material is devoid of roots and other living organisms and has not been changed by other biological activity.

Currently, soils are mapped according to the boundaries of major land resource areas (MLRAs). MLRAs are geographically associated land resource units that share common characteristics related to physiography, geology, climate, water resources, soils, biological resources, and land uses (USDA, 2006). Soil survey areas typically consist of parts of one or more MLRA.

The soils and miscellaneous areas in a survey area occur in an orderly pattern that is related to the geology, landforms, relief, climate, and natural vegetation of the area. Each kind of soil and miscellaneous area is associated with a particular kind of landform or with a segment of the landform. By observing the soils and miscellaneous areas in the survey area and relating their position to specific segments of the landform, a soil scientist develops a concept, or model, of how they were formed. Thus, during mapping, this model enables the soil scientist to predict with a considerable degree of accuracy the kind of soil or miscellaneous area at a specific location on the landscape.

Commonly, individual soils on the landscape merge into one another as their characteristics gradually change. To construct an accurate soil map, however, soil scientists must determine the boundaries between the soils. They can observe only a limited number of soil profiles. Nevertheless, these observations, supplemented by an understanding of the soil-vegetation-landscape relationship, are sufficient to verify predictions of the kinds of soil in an area and to determine the boundaries.

Soil scientists recorded the characteristics of the soil profiles that they studied. They noted soil color, texture, size and shape of soil aggregates, kind and amount of rock fragments, distribution of plant roots, reaction, and other features that enable them to identify soils. After describing the soils in the survey area and determining their properties, the soil scientists assigned the soils to taxonomic classes (units). Taxonomic classes are concepts. Each taxonomic class has a set of soil characteristics with precisely defined limits. The classes are used as a basis for comparison to classify soils systematically. Soil taxonomy, the system of taxonomic classification used in the United States, is based mainly on the kind and character of soil properties and the arrangement of horizons within the profile. After the soil

Custom Soil Resource Report

scientists classified and named the soils in the survey area, they compared the individual soils with similar soils in the same taxonomic class in other areas so that they could confirm data and assemble additional data based on experience and research.

The objective of soil mapping is not to delineate pure map unit components; the objective is to separate the landscape into landforms or landform segments that have similar use and management requirements. Each map unit is defined by a unique combination of soil components and/or miscellaneous areas in predictable proportions. Some components may be highly contrasting to the other components of the map unit. The presence of minor components in a map unit in no way diminishes the usefulness or accuracy of the data. The delineation of such landforms and landform segments on the map provides sufficient information for the development of resource plans. If intensive use of small areas is planned, onsite investigation is needed to define and locate the soils and miscellaneous areas.

Soil scientists make many field observations in the process of producing a soil map. The frequency of observation is dependent upon several factors, including scale of mapping, intensity of mapping, design of map units, complexity of the landscape, and experience of the soil scientist. Observations are made to test and refine the soil-landscape model and predictions and to verify the classification of the soils at specific locations. Once the soil-landscape model is refined, a significantly smaller number of measurements of individual soil properties are made and recorded. These measurements may include field measurements, such as those for color, depth to bedrock, and texture, and laboratory measurements, such as those for content of sand, silt, clay, salt, and other components. Properties of each soil typically vary from one point to another across the landscape.

Observations for map unit components are aggregated to develop ranges of characteristics for the components. The aggregated values are presented. Direct measurements do not exist for every property presented for every map unit component. Values for some properties are estimated from combinations of other properties.

While a soil survey is in progress, samples of some of the soils in the area generally are collected for laboratory analyses and for engineering tests. Soil scientists interpret the data from these analyses and tests as well as the field-observed characteristics and the soil properties to determine the expected behavior of the soils under different uses. Interpretations for all of the soils are field tested through observation of the soils in different uses and under different levels of management. Some interpretations are modified to fit local conditions, and some new interpretations are developed to meet local needs. Data are assembled from other sources, such as research information, production records, and field experience of specialists. For example, data on crop yields under defined levels of management are assembled from farm records and from field or plot experiments on the same kinds of soil.

Predictions about soil behavior are based not only on soil properties but also on such variables as climate and biological activity. Soil conditions are predictable over long periods of time, but they are not predictable from year to year. For example, soil scientists can predict with a fairly high degree of accuracy that a given soil will have a high water table within certain depths in most years, but they cannot predict that a high water table will always be at a specific level in the soil on a specific date.

After soil scientists located and identified the significant natural bodies of soil in the survey area, they drew the boundaries of these bodies on aerial photographs and

Custom Soil Resource Report

identified each as a specific map unit. Aerial photographs show trees, buildings, fields, roads, and rivers, all of which help in locating boundaries accurately.

Soil Map

The soil map section includes the soil map for the defined area of interest, a list of soil map units on the map and extent of each map unit, and cartographic symbols displayed on the map. Also presented are various metadata about data used to produce the map, and a description of each soil map unit.

Custom Soil Resource Report Soil Map (ROLLING HILLS TANK)

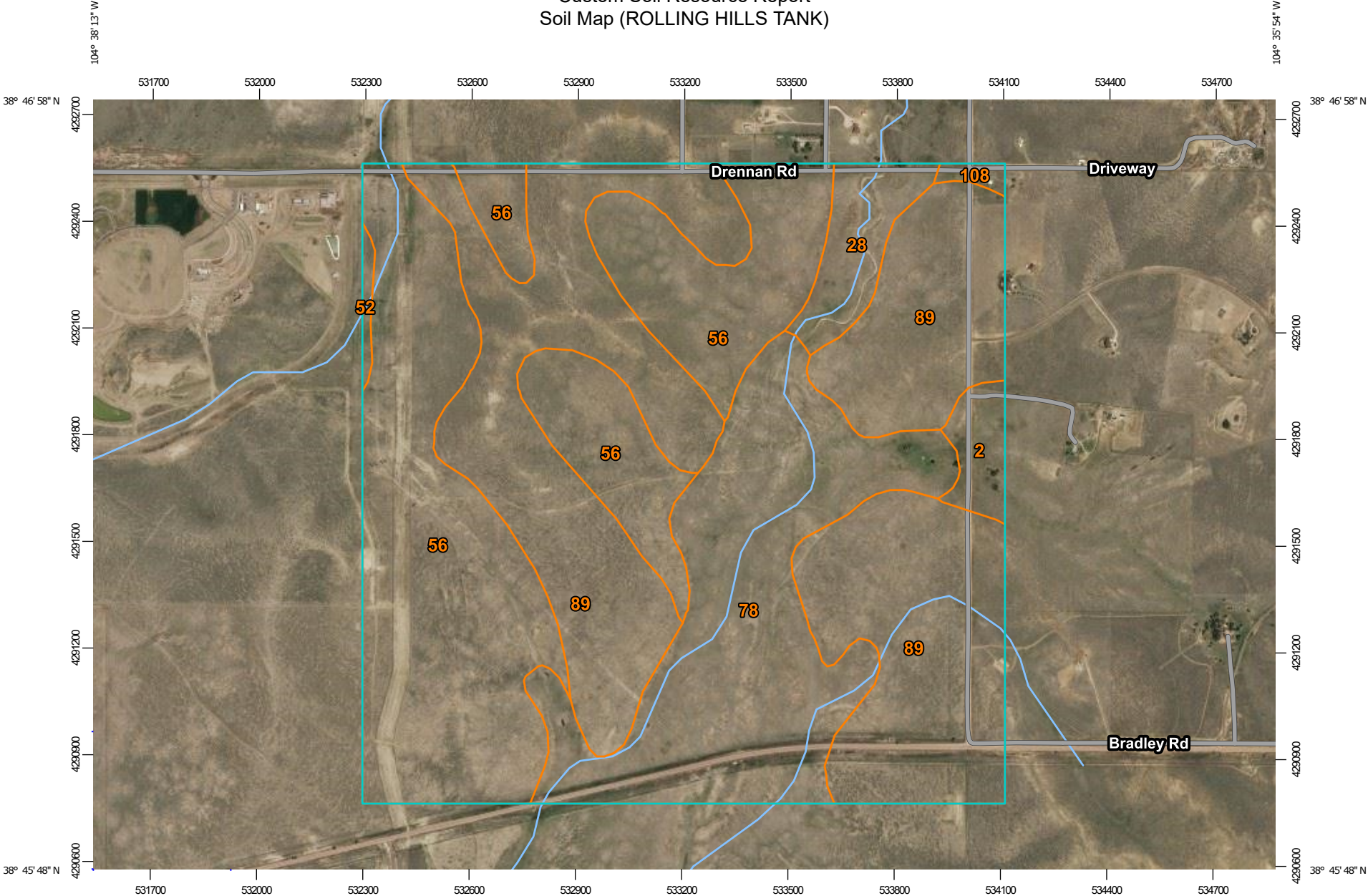

Map Scale: 1:15,300 if printed on A landscape (11" x 8.5") sheet.

0 200 400 800 1200 Meters

0 500 1000 2000 3000 Feet

Map projection: Web Mercator Corner coordinates: WGS84 Edge tics: UTM Zone 13N WGS84



MAP LEGEND

Area of Interest (AOI)

 Area of Interest (AOI)



















Soils

 Soil Map Unit Polygons

 Soil Map Unit Lines

 Soil Map Unit Points

Special Point Features

-  Blowout
-  Borrow Pit
-  Clay Spot
-  Closed Depression
-  Gravel Pit
-  Gravelly Spot
-  Landfill
-  Lava Flow
-  Marsh or swamp
-  Mine or Quarry
-  Miscellaneous Water
-  Perennial Water
-  Rock Outcrop
-  Saline Spot
-  Sandy Spot
-  Severely Eroded Spot
-  Sinkhole
-  Slide or Slip
-  Sodic Spot

-  Spoil Area
-  Stony Spot
-  Very Stony Spot
-  Wet Spot
-  Other
-  Special Line Features

Water Features

 Streams and Canals

Transportation

-  Rails
-  Interstate Highways
-  US Routes
-  Major Roads
-  Local Roads

Background

 Aerial Photography

MAP INFORMATION

The soil surveys that comprise your AOI were mapped at 1:24,000.

Please rely on the bar scale on each map sheet for map measurements.

Source of Map: Natural Resources Conservation Service
 Web Soil Survey URL:
 Coordinate System: Web Mercator (EPSG:3857)

Maps from the Web Soil Survey are based on the Web Mercator projection, which preserves direction and shape but distorts distance and area. A projection that preserves area, such as the Albers equal-area conic projection, should be used if more accurate calculations of distance or area are required.

This product is generated from the USDA-NRCS certified data as of the version date(s) listed below.

Soil Survey Area: El Paso County Area, Colorado
 Survey Area Data: Version 17, Sep 13, 2019

Soil map units are labeled (as space allows) for map scales 1:50,000 or larger.

Date(s) aerial images were photographed: Sep 8, 2018—May 26, 2019

The orthophoto or other base map on which the soil lines were compiled and digitized probably differs from the background imagery displayed on these maps. As a result, some minor shifting of map unit boundaries may be evident.

Map Unit Legend (ROLLING HILLS TANK)

Map Unit Symbol	Map Unit Name	Acres in AOI	Percent of AOI
2	Ascalon sandy loam, 1 to 3 percent slopes	13.3	1.6%
28	Ellicott loamy coarse sand, 0 to 5 percent slopes	25.0	3.1%
52	Manzanst clay loam, 0 to 3 percent slopes	2.9	0.4%
56	Nelson-Tassel fine sandy loams, 3 to 18 percent slopes	276.3	34.1%
78	Sampson loam, 0 to 3 percent slopes	164.9	20.4%
89	Tassel fine sandy loam, 3 to 18 percent slopes	324.7	40.1%
108	Wiley silt loam, 3 to 9 percent slopes	2.9	0.4%
Totals for Area of Interest		810.1	100.0%

Map Unit Descriptions (ROLLING HILLS TANK)

The map units delineated on the detailed soil maps in a soil survey represent the soils or miscellaneous areas in the survey area. The map unit descriptions, along with the maps, can be used to determine the composition and properties of a unit.

A map unit delineation on a soil map represents an area dominated by one or more major kinds of soil or miscellaneous areas. A map unit is identified and named according to the taxonomic classification of the dominant soils. Within a taxonomic class there are precisely defined limits for the properties of the soils. On the landscape, however, the soils are natural phenomena, and they have the characteristic variability of all natural phenomena. Thus, the range of some observed properties may extend beyond the limits defined for a taxonomic class. Areas of soils of a single taxonomic class rarely, if ever, can be mapped without including areas of other taxonomic classes. Consequently, every map unit is made up of the soils or miscellaneous areas for which it is named and some minor components that belong to taxonomic classes other than those of the major soils.

Most minor soils have properties similar to those of the dominant soil or soils in the map unit, and thus they do not affect use and management. These are called noncontrasting, or similar, components. They may or may not be mentioned in a particular map unit description. Other minor components, however, have properties and behavioral characteristics divergent enough to affect use or to require different management. These are called contrasting, or dissimilar, components. They generally are in small areas and could not be mapped separately because of the scale used. Some small areas of strongly contrasting soils or miscellaneous areas are identified by a special symbol on the maps. If included in the database for a

Custom Soil Resource Report

given area, the contrasting minor components are identified in the map unit descriptions along with some characteristics of each. A few areas of minor components may not have been observed, and consequently they are not mentioned in the descriptions, especially where the pattern was so complex that it was impractical to make enough observations to identify all the soils and miscellaneous areas on the landscape.

The presence of minor components in a map unit in no way diminishes the usefulness or accuracy of the data. The objective of mapping is not to delineate pure taxonomic classes but rather to separate the landscape into landforms or landform segments that have similar use and management requirements. The delineation of such segments on the map provides sufficient information for the development of resource plans. If intensive use of small areas is planned, however, onsite investigation is needed to define and locate the soils and miscellaneous areas.

An identifying symbol precedes the map unit name in the map unit descriptions. Each description includes general facts about the unit and gives important soil properties and qualities.

Soils that have profiles that are almost alike make up a *soil series*. Except for differences in texture of the surface layer, all the soils of a series have major horizons that are similar in composition, thickness, and arrangement.

Soils of one series can differ in texture of the surface layer, slope, stoniness, salinity, degree of erosion, and other characteristics that affect their use. On the basis of such differences, a soil series is divided into *soil phases*. Most of the areas shown on the detailed soil maps are phases of soil series. The name of a soil phase commonly indicates a feature that affects use or management. For example, Alpha silt loam, 0 to 2 percent slopes, is a phase of the Alpha series.

Some map units are made up of two or more major soils or miscellaneous areas. These map units are complexes, associations, or undifferentiated groups.

A *complex* consists of two or more soils or miscellaneous areas in such an intricate pattern or in such small areas that they cannot be shown separately on the maps. The pattern and proportion of the soils or miscellaneous areas are somewhat similar in all areas. Alpha-Beta complex, 0 to 6 percent slopes, is an example.

An *association* is made up of two or more geographically associated soils or miscellaneous areas that are shown as one unit on the maps. Because of present or anticipated uses of the map units in the survey area, it was not considered practical or necessary to map the soils or miscellaneous areas separately. The pattern and relative proportion of the soils or miscellaneous areas are somewhat similar. Alpha-Beta association, 0 to 2 percent slopes, is an example.

An *undifferentiated group* is made up of two or more soils or miscellaneous areas that could be mapped individually but are mapped as one unit because similar interpretations can be made for use and management. The pattern and proportion of the soils or miscellaneous areas in a mapped area are not uniform. An area can be made up of only one of the major soils or miscellaneous areas, or it can be made up of all of them. Alpha and Beta soils, 0 to 2 percent slopes, is an example.

Some surveys include *miscellaneous areas*. Such areas have little or no soil material and support little or no vegetation. Rock outcrop is an example.

El Paso County Area, Colorado

2—Ascalon sandy loam, 1 to 3 percent slopes

Map Unit Setting

National map unit symbol: 367q
Elevation: 5,500 to 6,500 feet
Mean annual precipitation: 14 to 16 inches
Mean annual air temperature: 47 to 50 degrees F
Frost-free period: 130 to 150 days
Farmland classification: Prime farmland if irrigated

Map Unit Composition

Ascalon and similar soils: 98 percent
Minor components: 2 percent
Estimates are based on observations, descriptions, and transects of the mapunit.

Description of Ascalon

Setting

Landform: Flats
Landform position (three-dimensional): Talf
Down-slope shape: Linear
Across-slope shape: Linear
Parent material: Mixed alluvium and/or eolian deposits

Typical profile

A - 0 to 8 inches: sandy loam
Bt - 8 to 21 inches: sandy clay loam
BC - 21 to 27 inches: sandy loam
Ck1 - 27 to 48 inches: sandy loam
Ck2 - 48 to 60 inches: loamy sand

Properties and qualities

Slope: 1 to 3 percent
Depth to restrictive feature: More than 80 inches
Natural drainage class: Well drained
Runoff class: Low
Capacity of the most limiting layer to transmit water (Ksat): Moderately high to high (0.60 to 2.00 in/hr)
Depth to water table: More than 80 inches
Frequency of flooding: None
Frequency of ponding: None
Calcium carbonate, maximum in profile: 10 percent
Salinity, maximum in profile: Nonsaline to very slightly saline (0.0 to 2.0 mmhos/cm)
Available water storage in profile: Moderate (about 7.1 inches)

Interpretive groups

Land capability classification (irrigated): 3e
Land capability classification (nonirrigated): 4e
Hydrologic Soil Group: B
Ecological site: Sandy Plains LRU's A & B (R069XY026CO)
Other vegetative classification: SANDY PLAINS (069BY026CO)
Hydric soil rating: No

Minor Components

Other soils

Percent of map unit: 1 percent
Hydric soil rating: No

Pleasant

Percent of map unit: 1 percent
Landform: Depressions
Hydric soil rating: Yes

28—Ellicott loamy coarse sand, 0 to 5 percent slopes

Map Unit Setting

National map unit symbol: 3680
Elevation: 5,500 to 6,500 feet
Mean annual precipitation: 13 to 15 inches
Mean annual air temperature: 47 to 50 degrees F
Frost-free period: 125 to 145 days
Farmland classification: Not prime farmland

Map Unit Composition

Ellicott and similar soils: 97 percent
Minor components: 3 percent
Estimates are based on observations, descriptions, and transects of the mapunit.

Description of Ellicott

Setting

Landform: Flood plains, stream terraces
Landform position (three-dimensional): Tread
Down-slope shape: Linear
Across-slope shape: Linear
Parent material: Sandy alluvium

Typical profile

A - 0 to 4 inches: loamy coarse sand
C - 4 to 60 inches: stratified coarse sand to sandy loam

Properties and qualities

Slope: 0 to 5 percent
Depth to restrictive feature: More than 80 inches
Natural drainage class: Somewhat excessively drained
Runoff class: Very low
Capacity of the most limiting layer to transmit water (Ksat): High to very high (5.95 to 19.98 in/hr)
Depth to water table: More than 80 inches
Frequency of flooding: Frequent
Frequency of ponding: None
Available water storage in profile: Low (about 4.1 inches)

Interpretive groups

Land capability classification (irrigated): None specified
Land capability classification (nonirrigated): 7w
Hydrologic Soil Group: A
Ecological site: Sandy Bottomland LRU's A & B (R069XY031CO)
Other vegetative classification: SANDY BOTTOMLAND (069AY031CO)
Hydric soil rating: No

Minor Components

Fluvaquentic haplaquoll

Percent of map unit: 1 percent
Landform: Swales
Hydric soil rating: Yes

Other soils

Percent of map unit: 1 percent
Hydric soil rating: No

Pleasant

Percent of map unit: 1 percent
Landform: Depressions
Hydric soil rating: Yes

52—Manzanst clay loam, 0 to 3 percent slopes

Map Unit Setting

National map unit symbol: 2w4nr
Elevation: 4,060 to 6,660 feet
Mean annual precipitation: 14 to 16 inches
Mean annual air temperature: 50 to 54 degrees F
Frost-free period: 130 to 170 days
Farmland classification: Prime farmland if irrigated

Map Unit Composition

Manzanst and similar soils: 85 percent
Minor components: 15 percent
Estimates are based on observations, descriptions, and transects of the mapunit.

Description of Manzanst

Setting

Landform: Terraces, drainageways
Landform position (three-dimensional): Tread
Down-slope shape: Linear
Across-slope shape: Linear, concave
Parent material: Clayey alluvium derived from shale

Typical profile

A - 0 to 3 inches: clay loam
Bt - 3 to 12 inches: clay

Custom Soil Resource Report

Btk - 12 to 37 inches: clay
Bk1 - 37 to 52 inches: clay
Bk2 - 52 to 79 inches: clay

Properties and qualities

Slope: 0 to 3 percent
Depth to restrictive feature: More than 80 inches
Natural drainage class: Well drained
Capacity of the most limiting layer to transmit water (Ksat): Moderately low to moderately high (0.06 to 0.20 in/hr)
Depth to water table: More than 80 inches
Frequency of flooding: None
Frequency of ponding: None
Calcium carbonate, maximum in profile: 15 percent
Gypsum, maximum in profile: 3 percent
Salinity, maximum in profile: Slightly saline (4.0 to 7.0 mmhos/cm)
Sodium adsorption ratio, maximum in profile: 10.0
Available water storage in profile: High (about 9.0 inches)

Interpretive groups

Land capability classification (irrigated): 3e
Land capability classification (nonirrigated): 4c
Hydrologic Soil Group: C
Ecological site: Saline Overflow (R067BY037CO)
Hydric soil rating: No

Minor Components

Ritoazul

Percent of map unit: 7 percent
Landform: Drainageways, interfluves
Landform position (three-dimensional): Rise
Down-slope shape: Linear
Across-slope shape: Linear
Ecological site: Clayey Plains (R067BY042CO)
Hydric soil rating: No

Arvada

Percent of map unit: 6 percent
Landform: Drainageways, interfluves
Down-slope shape: Linear
Across-slope shape: Linear
Ecological site: Salt Flat (R067BY033CO)
Hydric soil rating: No

Wiley

Percent of map unit: 2 percent
Landform: Interfluves
Down-slope shape: Linear
Across-slope shape: Linear
Ecological site: Loamy Plains (R067BY002CO)
Hydric soil rating: No

56—Nelson-Tassel fine sandy loams, 3 to 18 percent slopes

Map Unit Setting

National map unit symbol: 3690
Elevation: 5,600 to 6,400 feet
Mean annual precipitation: 12 to 14 inches
Mean annual air temperature: 48 to 52 degrees F
Frost-free period: 135 to 155 days
Farmland classification: Not prime farmland

Map Unit Composition

Nelson and similar soils: 55 percent
Tassel and similar soils: 40 percent
Minor components: 5 percent
Estimates are based on observations, descriptions, and transects of the mapunit.

Description of Nelson

Setting

Landform: Hills
Landform position (three-dimensional): Crest, side slope
Down-slope shape: Linear
Across-slope shape: Linear
Parent material: Calcareous residuum weathered from interbedded sedimentary rock

Typical profile

A - 0 to 5 inches: fine sandy loam
Ck - 5 to 23 inches: fine sandy loam
Cr - 23 to 27 inches: weathered bedrock

Properties and qualities

Slope: 3 to 12 percent
Depth to restrictive feature: 20 to 40 inches to paralithic bedrock
Natural drainage class: Well drained
Runoff class: Medium
Capacity of the most limiting layer to transmit water (Ksat): Moderately low to high (0.06 to 2.00 in/hr)
Depth to water table: More than 80 inches
Frequency of flooding: None
Frequency of ponding: None
Calcium carbonate, maximum in profile: 10 percent
Salinity, maximum in profile: Nonsaline to very slightly saline (0.0 to 2.0 mmhos/cm)
Available water storage in profile: Very low (about 2.8 inches)

Interpretive groups

Land capability classification (irrigated): 4e
Land capability classification (nonirrigated): 6e
Hydrologic Soil Group: B

Custom Soil Resource Report

Ecological site: Shaly Plains (R067BY045CO)
Other vegetative classification: SHALY PLAINS (069AY046CO)
Hydric soil rating: No

Description of Tassel

Setting

Landform: Hills
Landform position (three-dimensional): Crest, side slope
Down-slope shape: Linear
Across-slope shape: Linear
Parent material: Calcareous slope alluvium over residuum weathered from sandstone

Typical profile

A - 0 to 4 inches: fine sandy loam
C - 4 to 10 inches: fine sandy loam
Cr - 10 to 14 inches: weathered bedrock

Properties and qualities

Slope: 3 to 18 percent
Depth to restrictive feature: 6 to 20 inches to paralithic bedrock
Natural drainage class: Well drained
Runoff class: Medium
Capacity of the most limiting layer to transmit water (Ksat): Moderately high (0.20 to 0.60 in/hr)
Depth to water table: More than 80 inches
Frequency of flooding: None
Frequency of ponding: None
Calcium carbonate, maximum in profile: 10 percent
Available water storage in profile: Very low (about 1.2 inches)

Interpretive groups

Land capability classification (irrigated): None specified
Land capability classification (nonirrigated): 6s
Hydrologic Soil Group: D
Ecological site: Shaly Plains (R067BY045CO)
Other vegetative classification: SHALY PLAINS (069AY046CO)
Hydric soil rating: No

Minor Components

Other soils

Percent of map unit: 4 percent
Hydric soil rating: No

Pleasant

Percent of map unit: 1 percent
Landform: Depressions
Hydric soil rating: Yes

78—Sampson loam, 0 to 3 percent slopes

Map Unit Setting

National map unit symbol: 369s
Elevation: 5,500 to 6,500 feet
Mean annual precipitation: 13 to 15 inches
Mean annual air temperature: 47 to 50 degrees F
Frost-free period: 135 to 155 days
Farmland classification: Prime farmland if irrigated

Map Unit Composition

Sampson and similar soils: 95 percent
Minor components: 5 percent
Estimates are based on observations, descriptions, and transects of the mapunit.

Description of Sampson

Setting

Landform: Depressions, alluvial fans, terraces
Down-slope shape: Linear
Across-slope shape: Linear
Parent material: Alluvium

Typical profile

A - 0 to 15 inches: loam
Bt - 15 to 34 inches: clay loam
Bk - 34 to 60 inches: sandy clay loam

Properties and qualities

Slope: 0 to 3 percent
Depth to restrictive feature: More than 80 inches
Natural drainage class: Well drained
Runoff class: Low
Capacity of the most limiting layer to transmit water (Ksat): Moderately high to high (0.60 to 2.00 in/hr)
Depth to water table: More than 80 inches
Frequency of flooding: None
Frequency of ponding: None
Calcium carbonate, maximum in profile: 15 percent
Salinity, maximum in profile: Nonsaline to very slightly saline (0.0 to 2.0 mmhos/cm)
Available water storage in profile: High (about 9.2 inches)

Interpretive groups

Land capability classification (irrigated): 2e
Land capability classification (nonirrigated): 3c
Hydrologic Soil Group: B
Ecological site: Loamy Foothill (R049BY202CO)
Hydric soil rating: No

Minor Components

Other soils

Percent of map unit: 4 percent
Hydric soil rating: No

Pleasant

Percent of map unit: 1 percent
Landform: Depressions
Hydric soil rating: Yes

89—Tassel fine sandy loam, 3 to 18 percent slopes

Map Unit Setting

National map unit symbol: 36b5
Elevation: 5,600 to 6,400 feet
Mean annual precipitation: 13 to 15 inches
Mean annual air temperature: 47 to 51 degrees F
Frost-free period: 135 to 155 days
Farmland classification: Not prime farmland

Map Unit Composition

Tassel and similar soils: 95 percent
Minor components: 5 percent
Estimates are based on observations, descriptions, and transects of the mapunit.

Description of Tassel

Setting

Landform: Hills
Landform position (three-dimensional): Crest, side slope
Down-slope shape: Linear
Across-slope shape: Linear
Parent material: Calcareous slope alluvium over residuum weathered from sandstone

Typical profile

A - 0 to 4 inches: fine sandy loam
C - 4 to 10 inches: sandy loam
Cr - 10 to 14 inches: weathered bedrock

Properties and qualities

Slope: 3 to 18 percent
Depth to restrictive feature: 6 to 20 inches to paralithic bedrock
Natural drainage class: Well drained
Runoff class: Medium
Capacity of the most limiting layer to transmit water (Ksat): Moderately high (0.20 to 0.60 in/hr)
Depth to water table: More than 80 inches
Frequency of flooding: None

Custom Soil Resource Report

Frequency of ponding: None
Calcium carbonate, maximum in profile: 10 percent
Available water storage in profile: Very low (about 1.2 inches)

Interpretive groups

Land capability classification (irrigated): None specified
Land capability classification (nonirrigated): 6s
Hydrologic Soil Group: D
Ecological site: Sandy Plains (R067BY024CO)
Other vegetative classification: SANDY PLAINS (069AY026CO)
Hydric soil rating: No

Minor Components

Other soils

Percent of map unit: 5 percent
Hydric soil rating: No

108—Wiley silt loam, 3 to 9 percent slopes

Map Unit Setting

National map unit symbol: 367b
Elevation: 5,200 to 6,200 feet
Mean annual precipitation: 12 to 14 inches
Mean annual air temperature: 48 to 52 degrees F
Frost-free period: 135 to 155 days
Farmland classification: Not prime farmland

Map Unit Composition

Wiley and similar soils: 95 percent
Minor components: 5 percent
Estimates are based on observations, descriptions, and transects of the mapunit.

Description of Wiley

Setting

Landform: Hills
Landform position (three-dimensional): Side slope
Down-slope shape: Linear
Across-slope shape: Linear
Parent material: Calcareous silty eolian deposits

Typical profile

A - 0 to 4 inches: silt loam
Bt - 4 to 16 inches: silt loam
Bk - 16 to 60 inches: silt loam

Properties and qualities

Slope: 3 to 9 percent
Depth to restrictive feature: More than 80 inches
Natural drainage class: Well drained

Custom Soil Resource Report

Runoff class: Medium

Capacity of the most limiting layer to transmit water (Ksat): Moderately high to high (0.60 to 2.00 in/hr)

Depth to water table: More than 80 inches

Frequency of flooding: None

Frequency of ponding: None

Calcium carbonate, maximum in profile: 15 percent

Salinity, maximum in profile: Nonsaline to very slightly saline (0.0 to 2.0 mmhos/cm)

Available water storage in profile: High (about 11.5 inches)

Interpretive groups

Land capability classification (irrigated): 4e

Land capability classification (nonirrigated): 6e

Hydrologic Soil Group: B

Ecological site: Loamy Plains (R067BY002CO)

Other vegetative classification: LOAMY PLAINS (069AY006CO)

Hydric soil rating: No

Minor Components

Other soils

Percent of map unit: 4 percent

Hydric soil rating: No

Pleasant

Percent of map unit: 1 percent

Landform: Depressions

Hydric soil rating: Yes

References

- American Association of State Highway and Transportation Officials (AASHTO). 2004. Standard specifications for transportation materials and methods of sampling and testing. 24th edition.
- American Society for Testing and Materials (ASTM). 2005. Standard classification of soils for engineering purposes. ASTM Standard D2487-00.
- Cowardin, L.M., V. Carter, F.C. Golet, and E.T. LaRoe. 1979. Classification of wetlands and deep-water habitats of the United States. U.S. Fish and Wildlife Service FWS/OBS-79/31.
- Federal Register. July 13, 1994. Changes in hydric soils of the United States.
- Federal Register. September 18, 2002. Hydric soils of the United States.
- Hurt, G.W., and L.M. Vasilas, editors. Version 6.0, 2006. Field indicators of hydric soils in the United States.
- National Research Council. 1995. Wetlands: Characteristics and boundaries.
- Soil Survey Division Staff. 1993. Soil survey manual. Soil Conservation Service. U.S. Department of Agriculture Handbook 18. http://www.nrcs.usda.gov/wps/portal/nrcs/detail/national/soils/?cid=nrcs142p2_054262
- Soil Survey Staff. 1999. Soil taxonomy: A basic system of soil classification for making and interpreting soil surveys. 2nd edition. Natural Resources Conservation Service, U.S. Department of Agriculture Handbook 436. http://www.nrcs.usda.gov/wps/portal/nrcs/detail/national/soils/?cid=nrcs142p2_053577
- Soil Survey Staff. 2010. Keys to soil taxonomy. 11th edition. U.S. Department of Agriculture, Natural Resources Conservation Service. http://www.nrcs.usda.gov/wps/portal/nrcs/detail/national/soils/?cid=nrcs142p2_053580
- Tiner, R.W., Jr. 1985. Wetlands of Delaware. U.S. Fish and Wildlife Service and Delaware Department of Natural Resources and Environmental Control, Wetlands Section.
- United States Army Corps of Engineers, Environmental Laboratory. 1987. Corps of Engineers wetlands delineation manual. Waterways Experiment Station Technical Report Y-87-1.
- United States Department of Agriculture, Natural Resources Conservation Service. National forestry manual. http://www.nrcs.usda.gov/wps/portal/nrcs/detail/soils/home/?cid=nrcs142p2_053374
- United States Department of Agriculture, Natural Resources Conservation Service. National range and pasture handbook. <http://www.nrcs.usda.gov/wps/portal/nrcs/detail/national/landuse/rangepasture/?cid=stelprdb1043084>

Custom Soil Resource Report

United States Department of Agriculture, Natural Resources Conservation Service. National soil survey handbook, title 430-VI. http://www.nrcs.usda.gov/wps/portal/nrcs/detail/soils/scientists/?cid=nrcs142p2_054242

United States Department of Agriculture, Natural Resources Conservation Service. 2006. Land resource regions and major land resource areas of the United States, the Caribbean, and the Pacific Basin. U.S. Department of Agriculture Handbook 296. http://www.nrcs.usda.gov/wps/portal/nrcs/detail/national/soils/?cid=nrcs142p2_053624

United States Department of Agriculture, Soil Conservation Service. 1961. Land capability classification. U.S. Department of Agriculture Handbook 210. http://www.nrcs.usda.gov/Internet/FSE_DOCUMENTS/nrcs142p2_052290.pdf

Appendix B

2020/08/07 1:47 PM By: Shelby West j:_JDS-Hydro\Project Files\102 Widefield Water And San\102.121 Rolling Hills Tank\Drawings\Working\102121_FEMA.dwg

NOTE:
SEE FIRM 08041C07090G (12/07/08)
REVALIDATIONS PER FEMA.GOV



LEGEND

- SPECIAL FLOOD HAZARD AREAS (SFHAS) SUBJECT TO INUNDATION BY THE 1% ANNUAL CHANCE FLOOD
- ZONE AE** Base Flood Elevations determined.
- FLOODWAY AREAS IN ZONE AE
- Floodway boundary
- 513 Base Flood Elevation line and value; elevation in feet*
- Cross section line

MAP SCALE 1" = 1000'

500 0 1000 2000

FEET

300 0 300 600

METERS

NFP PANEL 0790G

FIRM
FLOOD INSURANCE RATE MAP
EL PASO COUNTY,
COLORADO
AND INCORPORATED AREAS

PANEL 790 OF 1300
(SEE MAP INDEX FOR FIRM PANEL LAYOUT)

CONTAINS:

COMMUNITY	NUMBER	PANEL	SUFFIX
COLORADO SPRINGS, CITY OF	080060	0790	G
EL PASO COUNTY	080029	0790	G

Notice to User: The Map Number shown below should be used when placing map orders. The Community Number shown above should be used on insurance applications for the subject community.

MAP NUMBER
08041C0790G

MAP REVISED
DECEMBER 7, 2018

Federal Emergency Management Agency

JDS-HYDRO CONSULTANTS, INC.
 5440 TECH CENTER DR., SUITE 100
 COLORADO SPRINGS, COLORADO 80919
 (719) 227-0072
DISCLAIMER: THE CONTRACTOR SHALL VERIFY ALL DIMENSIONS. ANY ERRORS OR OMISSIONS SHALL BE REPORTED TO JDS-HYDRO CONSULTANTS, INC. JDS-HYDRO ASSUMES NO LIABILITY FOR UNAUTHORIZED CHANGES AND/OR REVISIONS MADE TO PLANS.

WIDEFIELD WATER AND SANITATION DISTRICT
 ROLLING HILLS 2MG POTABLE WATER TANK AND INLET PIPELINE
 FEMA FLOODPLAIN MAP

NO.	DESCRIPTION	BY	APP.	DATE
1				
2				
3				
4				
5				
6				
7				

80% DESIGN

Project No.: 102.121
Date: 08/07/20
Design: GJD
Drawn: SNW
Check: JPM

Appendix C

DRAINAGE CALCULATIONS
Widefield Water and Sanitation District
Rolling Hills Tank

1 - RUNOFF COEFFICIENT CALCULATION

Subbasin A (Franceville Tributary)

<i>Developed Area</i>						
Surface Type	Area (SF)	Area (AC)	C5	C10	C100	
Undeveloped Land - Pasture/Meadow	63,162	1.45	0.15	0.25	0.50	0.50

Subbasin B (East Fork Tributary)

<i>Developed Area</i>						
Surface Type	Area (SF)	Area (AC)	C5	C10	C100	
Undeveloped Land - Pasture/Meadow	38,333	0.88	0.15	0.25	0.50	0.50

Subbasin C - Tank Site Improvements

<i>Developed Area</i>									
Surface Type	Area (SF)	Area (AC)	C5	C10	C100	Composite C5	Composite C10	Composite C100	
Roof	7620	0.1749341	0.75	0.77	0.83	5715	5867	6325	
Gravel Driveway	25,343	0.5817852	0.63	0.66	0.74	15966	16726	18753	
Vegetated Swale	5,950	0.1365932	0.15	0.25	0.50	893	1488	2975	
Undeveloped Land - Pasture/Meadow	37,753	0.8666875	0.15	0.25	0.50	5663	9438	18876	
	76,666	1.76				0.37	0.44	0.61	

Subbasin D - Drainage to Access Rd. Culvert

<i>Developed Area</i>									
Surface Type	Area (SF)	Area (AC)	C5	C10	C100	Composite C5	Composite C10	Composite C100	
Gravel Driveway	7,500	0.1721763	0.63	0.66	0.74	4725	4950	5550.00	
Vegetated Swale	2,500	0.0573921	0.15	0.25	0.50	375	625	1250.00	
Undeveloped Land - Pasture Meadow	44014.4	1.0104316	0.15	0.25	0.50	6602.16	11003.6	22007.20	
	54,014	1.24				0.22	0.31	0.53	

2 -TIME OF CONCENTRATION CALCULATION

El Paso County Drainage Criteria Manual V1 Update (Eqn. 6-7, 6-8, 6-9)

Developed

Subbasin A (Franceville Tributary)

Overland Flow Length (ft)based on Design	
Point DP-EX-A	144
C5	0.15
Land Slope ft/ft)	0.049
Ti (min)	12.18
Channelized Length (ft)	0.00
NRCS Conveyance Factor	20.00
Waterway Slope ft/ft)	0.02
Tt (min)	0.00
Tc (min)	12.18

Subbasin B (East Fork Tributary)

Overland Flow Length (ft)	170
C5	0.15
Land Slope ft/ft)	0.097
Ti (min)	10.57
Channelized Length (ft)	0.00
NRCS Conveyance Factor	20.00
Waterway Slope ft/ft)	0.02
Tt (min)	0.00
Tc (min)	10.57

Subbasin C - Tank Site Improvements

Overland Flow Length (ft)	50
C5	0.37
Land Slope ft/ft)	0.02
Ti (min)	7.43
Channelized Length (ft)	950.00
NRCS Conveyance Factor	20.00
Waterway Slope ft/ft)	0.01
Tt (min)	7.23
Tc (min)	14.66

Subbasin D - Drainage to Access Rd. Culvert

Overland Flow Length (ft)	120
C5	0.22
Land Slope ft/ft)	0.02
Ti (min)	13.90
Channelized Length (ft)	200.00
NRCS Conveyance Factor	20.00
Waterway Slope ft/ft)	0.04
Tt (min)	0.87
Tc (min)	14.77

3 - HISTORICAL AND DEVELOPED FLOWRATE CALCULATIONS

Q = CiA, calculated I using Figure 6-5 of the El Paso County Drainage Criteria Manual V1 Update

10-Year Storm

Subbasin A (Franceville Tributary)

Undeveloped Drainage Basin 10-Year Storm					
Area (acres)	C10	i (in/hr)	Q (acre-in/hr)	Q (CFS)	
1.88		0.2500	4.47	2.10	2.10
Developed Drainage Basin 10-Year Storm					
Area (acres)	C10	i (in/hr)	Q (acre-in/hr)	Q (CFS)	
1.45		0.2500	4.47	1.62	1.62
Subbasin A Increase (CFS)					-0.48

-30% Runoff Reduction

Subbasin B (East Fork Tributary)

Historic Drainage Basin 10-Year Storm					
Area (acres)	C10	i (in/hr)	Q (acre-in/hr)	Q (CFS)	
1.07		0.2500	4.72	1.26	1.26
Developed Drainage Basin 10-Year Storm					
Area (acres)	C10	i (in/hr)	Q (acre-in/hr)	Q (CFS)	
0.88		0.2500	4.72	1.04	1.04
Subbasin B Increase (CFS)					-0.22

-22% Runoff Reduction

Subbasin C - Tank Site Improvements

Developed Drainage Basin 10-Year Storm					
Area (acres)	C10	i (in/hr)	Q (acre-in/hr)	Q (CFS)	
1.76		0.4372	4.15	3.19	3.19

Subbasin D - Drainage to Access Rd. Culvert

Developed Drainage Basin 10-Year Storm					
Area (acres)	C10	i (in/hr)	Q (acre-in/hr)	Q (CFS)	
1.1		0.3069	4.14	1.40	1.40

100-Year Storm**Subbasin A (Franceville Tributary)**

Undeveloped Drainage Basin 100-Year Storm					
Area (acres)	C100	i (in/hr)	Q (acre-in/hr)	Q (CFS)	
1.88		0.5000	6.43	6.05	6.05
Developed Drainage Basin 100-Year Storm					
Area (acres)	C100	i (in/hr)	Q (acre-in/hr)	Q (CFS)	
1.45		0.5000	6.43	4.67	4.67
Subbasin A Increase (CFS)					-1.38

-30% Runoff Reduction

Subbasin B (East Fork Tributary)

Historic Drainage Basin 100-Year Storm					
Area (acres)	C100	i (in/hr)	Q (acre-in/hr)	Q (CFS)	
1.07		0.5000	6.79	3.63	3.63
Developed Drainage Basin 100-Year Storm					
Area (acres)	C100	i (in/hr)	Q (acre-in/hr)	Q (CFS)	
0.88		0.5000	6.79	2.99	2.99
Subbasin B Increase (CFS)					-0.65

-22% Runoff Reduction

Subbasin C - Tank Site Improvements

Developed Drainage Basin 100-Year Storm					
Area (acres)	C100	i (in/hr)	Q (acre-in/hr)	Q (CFS)	
1.76		0.6121	5.97	6.43	6.43

Subbasin D - Drainage to Access Rd. Culvert

Developed Drainage Basin 100-Year Storm					
Area (acres)	C100	i (in/hr)	Q (acre-in/hr)	Q (CFS)	
1.1		0.5333	5.95	3.49	3.49

Appendix D

DETENTION BASIN STAGE-STORAGE TABLE BUILDER

MHFD-Detention, Version 4.00 (December 2019)

Project: **Widfield Water and Sanitation District - Rolling Hills Tank**

Basin ID: **Subbasin C**

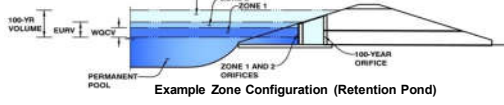

Example Zone Configuration (Retention Pond)

Watershed Information

Selected BMP Type =	SF	Note: L / W Ratio > 8
Watershed Area =	1.76 acres	L / W Ratio = 13.04
Watershed Length =	1,000 ft	
Watershed Length to Centroid =	650 ft	
Watershed Slope =	0.012 ft/ft	
Watershed Imperviousness =	36.00% percent	
Percentage Hydrologic Soil Group A =	0.0% percent	
Percentage Hydrologic Soil Group B =	0.0% percent	
Percentage Hydrologic Soil Groups C/D =	100.0% percent	
Target WQCV Drain Time =	12.0 hours	
Location for 1-hr Rainfall Depths =	User Input	

Water Quality Capture Volume (WQCV) =	0.020 acre-feet	
Excess Urban Runoff Volume (EURV) =	0.058 acre-feet	
2-yr Runoff Volume (P1 = 0.69 in.) =	0.028 acre-feet	0.69 inches
5-yr Runoff Volume (P1 = 0.98 in.) =	0.048 acre-feet	0.98 inches
10-yr Runoff Volume (P1 = 1.23 in.) =	0.076 acre-feet	1.23 inches
25-yr Runoff Volume (P1 = 1.58 in.) =	0.134 acre-feet	1.58 inches
50-yr Runoff Volume (P1 = 1.86 in.) =	0.174 acre-feet	1.86 inches
100-yr Runoff Volume (P1 = 2.14 in.) =	0.222 acre-feet	2.14 inches
500-yr Runoff Volume (P1 = 2.84 in.) =	0.330 acre-feet	2.84 inches
Approximate 2-yr Detention Volume =	0.029 acre-feet	
Approximate 5-yr Detention Volume =	0.053 acre-feet	
Approximate 10-yr Detention Volume =	0.065 acre-feet	
Approximate 25-yr Detention Volume =	0.081 acre-feet	
Approximate 50-yr Detention Volume =	0.089 acre-feet	
Approximate 100-yr Detention Volume =	0.109 acre-feet	

Define Zones and Basin Geometry

Zone 1 Volume (WQCV) =	0.020 acre-feet
Zone 2 Volume (EURV - Zone 1) =	0.039 acre-feet
Zone 3 Volume (100-year - Zones 1 & 2) =	0.051 acre-feet
Total Detention Basin Volume =	0.109 acre-feet
Initial Surcharge Volume (ISV) =	N/A ft ³
Initial Surcharge Depth (ISD) =	N/A ft
Total Available Detention Depth (H _{total}) =	2.00 ft
Depth of Trickle Channel (H _{TC}) =	N/A ft
Slope of Trickle Channel (S _{TC}) =	N/A ft/ft
Slopes of Main Basin Sides (S _{main}) =	4 H:V
Basin Length-to-Width Ratio (R _{L/W}) =	2

Initial Surcharge Area (A _{ISV}) =	0 ft ²
Surcharge Volume Length (L _{ISV}) =	0.0 ft
Surcharge Volume Width (W _{ISV}) =	0.0 ft
Depth of Basin Floor (H _{FLOOR}) =	0.00 ft
Length of Basin Floor (L _{FLOOR}) =	56.8 ft
Width of Basin Floor (W _{FLOOR}) =	28.4 ft
Area of Basin Floor (A _{FLOOR}) =	1,612 ft ²
Volume of Basin Floor (V _{FLOOR}) =	0 ft ³
Depth of Main Basin (H _{MAIN}) =	2.00 ft
Length of Main Basin (L _{MAIN}) =	72.8 ft
Width of Main Basin (W _{MAIN}) =	44.4 ft
Area of Main Basin (A _{MAIN}) =	3,231 ft ²
Volume of Main Basin (V _{MAIN}) =	4,750 ft ³
Calculated Total Basin Volume (V _{total}) =	0.109 acre-feet

Depth Increment = 0.10 ft

Stage - Storage Description	Stage (ft)	Optional Override Stage (ft)	Length (ft)	Width (ft)	Area (ft ²)	Optional Override Area (ft ²)	Area (acre)	Volume (ft ³)	Volume (ac-ft)
Media Surface	0.00		56.8	28.4	1,612		0.037		
	0.10		57.6	29.2	1,681		0.039	165	0.004
	0.20		58.4	30.0	1,751		0.040	336	0.008
	0.30		59.2	30.8	1,822		0.042	515	0.012
	0.40		60.0	31.6	1,895		0.043	701	0.016
Zone 1 (WQCV)	0.49		60.7	32.3	1,961		0.045	874	0.020
	0.50		60.8	32.4	1,969		0.045	894	0.021
	0.60		61.6	33.2	2,044		0.047	1,094	0.025
	0.70		62.4	34.0	2,120		0.049	1,303	0.030
	0.80		63.2	34.8	2,198		0.050	1,519	0.035
	0.90		64.0	35.6	2,277		0.052	1,742	0.040
	1.00		64.8	36.4	2,357		0.054	1,974	0.045
	1.10		65.6	37.2	2,439		0.056	2,214	0.051
	1.20		66.4	38.0	2,522		0.058	2,462	0.057
Zone 2 (EURV)	1.24		66.7	38.3	2,555		0.059	2,563	0.059
	1.30		67.2	38.8	2,606		0.060	2,718	0.062
	1.40		68.0	39.6	2,691		0.062	2,983	0.068
	1.50		68.8	40.4	2,778		0.064	3,257	0.075
	1.60		69.6	41.2	2,866		0.066	3,539	0.081
	1.70		70.4	42.0	2,955		0.068	3,830	0.088
	1.80		71.2	42.8	3,046		0.070	4,130	0.095
	1.90		72.0	43.6	3,138		0.072	4,439	0.102
Zone 3 (100-year)	2.00		72.8	44.4	3,231		0.074	4,758	0.109
	2.10		73.6	45.2	3,325		0.076	5,085	0.117
	2.20		74.4	46.0	3,421		0.079	5,423	0.124
	2.30		75.2	46.8	3,518		0.081	5,770	0.132
	2.40		76.0	47.6	3,616		0.083	6,126	0.141
	2.50		76.8	48.4	3,715		0.085	6,493	0.149
	2.60		77.6	49.2	3,816		0.088	6,869	0.158
	2.70		78.4	50.0	3,918		0.090	7,256	0.167
	2.80		79.2	50.8	4,022		0.092	7,653	0.176
	2.90		80.0	51.6	4,126		0.095	8,060	0.185
	3.00		80.8	52.4	4,232		0.097	8,478	0.195
	3.10		81.6	53.2	4,339		0.100	8,907	0.204
	3.20		82.4	54.0	4,448		0.102	9,346	0.215
	3.30		83.2	54.8	4,558		0.105	9,796	0.225
	3.40		84.0	55.6	4,669		0.107	10,258	0.235
	3.50		84.8	56.4	4,781		0.110	10,730	0.246
	3.60		85.6	57.2	4,894		0.112	11,214	0.257
	3.70		86.4	58.0	5,009		0.115	11,709	0.269
	3.80		87.2	58.8	5,125		0.118	12,216	0.280
	3.90		88.0	59.6	5,243		0.120	12,734	0.292
	4.00		88.8	60.4	5,362		0.123	13,265	0.305
	4.10		89.6	61.2	5,482		0.126	13,807	0.317
	4.20		90.4	62.0	5,603		0.129	14,361	0.330
	4.30		91.2	62.8	5,725		0.131	14,927	0.343
	4.40		92.0	63.6	5,849		0.134	15,506	0.356
	4.50		92.8	64.4	5,974		0.137	16,097	0.370
	4.60		93.6	65.2	6,101		0.140	16,701	0.383
	4.70		94.4	66.0	6,228		0.143	17,317	0.398
	4.80		95.2	66.8	6,357		0.146	17,947	0.412
	4.90		96.0	67.6	6,487		0.149	18,589	0.427
	5.00		96.8	68.4	6,619		0.152	19,244	0.442
	5.10		97.6	69.2	6,752		0.155	19,913	0.457
	5.20		98.4	70.0	6,886		0.158	20,594	0.473
	5.30		99.2	70.8	7,021		0.161	21,290	0.489
	5.40		100.0	71.6	7,158		0.164	21,999	0.505
	5.50		100.8	72.4	7,296		0.167	22,721	0.522
	5.60		101.6	73.2	7,435		0.171	23,458	0.539
	5.70		102.4	74.0	7,575		0.174	24,208	0.556
	5.80		103.2	74.8	7,717		0.177	24,973	0.573
	5.90		104.0	75.6	7,860		0.180	25,752	0.591
	6.00		104.8	76.4	8,004		0.184	26,545	0.609
	6.10		105.6	77.2	8,150		0.187	27,353	0.628
	6.20		106.4	78.0	8,297		0.190	28,175	0.647
	6.30		107.2	78.8	8,445		0.194	29,012	0.666
	6.40		108.0	79.6	8,594		0.197	29,864	0.686
	6.50		108.8	80.4	8,745		0.201	30,731	0.705
	6.60		109.6	81.2	8,897		0.204	31,613	0.726
	6.70		110.4	82.0	9,050		0.208	32,510	0.746
	6.80		111.2	82.8	9,205		0.211	33,423	0.767
	6.90		112.0	83.6	9,361		0.215	34,351	0.789
	7.00		112.8	84.4	9,518		0.218	35,295	0.810
	7.10		113.6	85.2	9,676		0.222	36,255	0.832
	7.20		114.4	86.0	9,836		0.226	37,231	0.855
	7.30		115.2	86.8	9,997		0.229	38,222	0.877
	7.40		116.0	87.6	10,159		0.233	39,230	0.901
	7.50		116.8	88.4	10,322		0.237	40,254	0.924
	7.60		117.6	89.2	10,487		0.241	41,294	0.948
	7.70		118.4	90.0	10,653		0.245	42,351	0.972
	7.80		119.2	90.8	10,821		0.248	43,425	0.997
	7.90		120.0	91.6	10,989		0.252	44,516	1.022
	8.00		120.8	92.4	11,159		0.256	45,623	1.047
	8.10		121.6	93.2	11,330		0.260	46,747	1.073
	8.20		122.4	94.0	11,503		0.264	47,889	1.099
	8.30		123.2	94.8	11,676		0.268	49,048	1.126
	8.40		124.0	95.6	11,851		0.272	50,224	1.153
	8.50		124.8	96.4	12,028		0.276	51,418	1.180
	8.60		125.6	97.2	12,205		0.280	52,630	1.208
	8.70		126.4	98.0	12,384		0.284	53,859	1.236
	8.80		127.2	98.8	12,564		0.288	55,107	1.265
	8.90		128.0	99.6	12,746		0.293	56,372	1.294
	9.00		128.8	100.4	12,928		0.297	57,656	1.324
	9.10		129.6	101.2	13,112		0.301	58,958	1.353
	9.20		130.4	102.0	13,298		0.305	60,279	1.384
	9.30		131.2	102.8	13,484		0.310	61,618	1.415
	9.40		132.0	103.6	13,672				

DETENTION BASIN STAGE-STORAGE TABLE BUILDER

MHFD-Detention, Version 4.00 (December 2019)

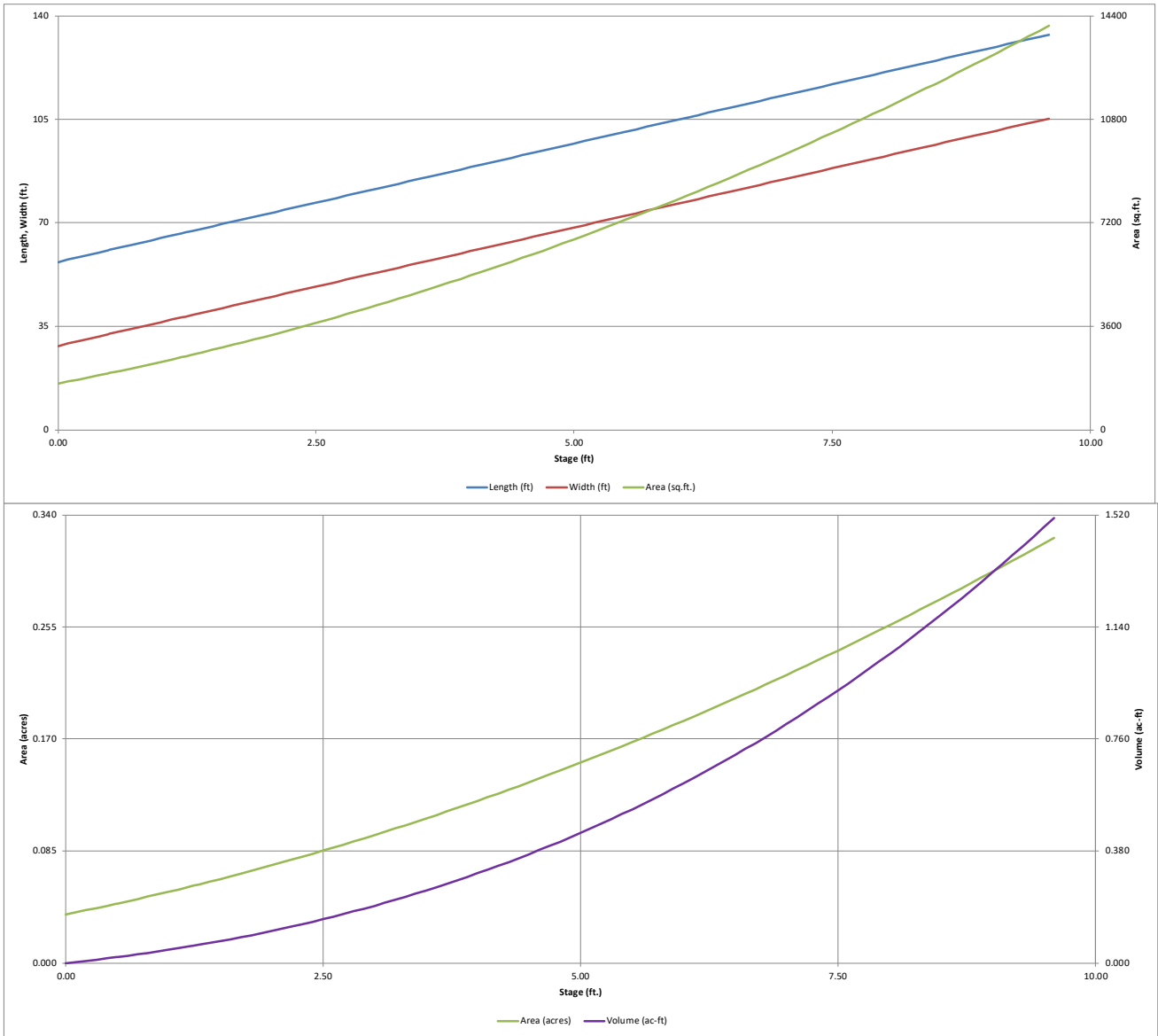

DETENTION BASIN OUTLET STRUCTURE DESIGN

MHFD-Detention, Version 4.00 (December 2019)

Project: Widefield Water and Sanitation District - Rolling Hills Tank

Basin ID: Subbasin C

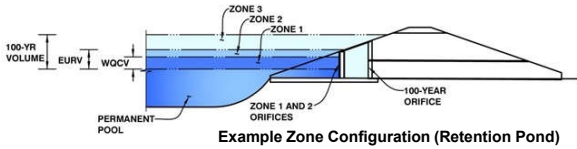

	Estimated Stage (ft)	Estimated Volume (ac-ft)	Outlet Type
Zone 1 (WQCV)	0.49	0.020	Filtration Media
Zone 2 (EURV)	1.24	0.039	Circular Orifice
Zone 3 (100-year)	2.00	0.051	Weir&Pipe (Circular)
Total (all zones)		0.109	

User Input: Orifice at Underdrain Outlet (typically used to drain WQCV in a Filtration BMP)

Underdrain Orifice Invert Depth =	1.83	ft (distance below the filtration media surface)
Underdrain Orifice Diameter =	0.35	inches

Underdrain Orifice Area =	0.0	ft ²
Underdrain Orifice Centroid =	0.01	feet

User Input: Orifice Plate with one or more orifices or Elliptical Slot Weir (typically used to drain WQCV and/or EURV in a sedimentation BMP)

Invert of Lowest Orifice =	N/A	ft (relative to basin bottom at Stage = 0 ft)
Depth at top of Zone using Orifice Plate =	N/A	ft (relative to basin bottom at Stage = 0 ft)
Orifice Plate: Orifice Vertical Spacing =	N/A	inches
Orifice Plate: Orifice Area per Row =	N/A	inches

WQ Orifice Area per Row =	N/A	ft ²
Elliptical Half-Width =	N/A	feet
Elliptical Slot Centroid =	N/A	feet
Elliptical Slot Area =	N/A	ft ²

User Input: Stage and Total Area of Each Orifice Row (numbered from lowest to highest)

	Row 1 (optional)	Row 2 (optional)	Row 3 (optional)	Row 4 (optional)	Row 5 (optional)	Row 6 (optional)	Row 7 (optional)	Row 8 (optional)
Stage of Orifice Centroid (ft)	N/A	N/A	N/A	N/A	N/A	N/A	N/A	N/A
Orifice Area (sq. inches)	N/A	N/A	N/A	N/A	N/A	N/A	N/A	N/A

	Row 9 (optional)	Row 10 (optional)	Row 11 (optional)	Row 12 (optional)	Row 13 (optional)	Row 14 (optional)	Row 15 (optional)	Row 16 (optional)
Stage of Orifice Centroid (ft)	N/A	N/A	N/A	N/A	N/A	N/A	N/A	N/A
Orifice Area (sq. inches)	N/A	N/A	N/A	N/A	N/A	N/A	N/A	N/A

User Input: Vertical Orifice (Circular or Rectangular)

	Zone 2 Circular	Not Selected	
Invert of Vertical Orifice =	0.15	N/A	ft (relative to basin bottom at Stage = 0 ft)
Depth at top of Zone using Vertical Orifice =	0.50	N/A	ft (relative to basin bottom at Stage = 0 ft)
Vertical Orifice Diameter =	3.00	N/A	inches

	Zone 2 Circular	Not Selected	
Vertical Orifice Area =	0.05	N/A	ft ²
Vertical Orifice Centroid =	0.13	N/A	feet

User Input: Overflow Weir (Dropbox with Flat or Sloped Gate and Outlet Pipe OR Rectangular/Trapezoidal Weir (and No Outlet Pipe))

	Zone 3 Weir	Not Selected	
Overflow Weir Front Edge Height, H _o =	0.45	N/A	ft (relative to basin bottom at Stage = 0 ft)
Overflow Weir Front Edge Length =	4.00	N/A	feet
Overflow Weir Gate Slope =	3.00	N/A	H:V
Horiz. Length of Weir Sides =	4.00	N/A	feet
Overflow Gate Open Area % =	70%	N/A	%, gate open area/total area
Debris Clogging % =	0%	N/A	%

	Zone 3 Weir	Not Selected	
Height of Gate Upper Edge, H _t =	1.78	N/A	feet
Overflow Weir Slope Length =	4.22	N/A	feet
Gate Open Area / 100-yr Orifice Area =	86.58	N/A	
Overflow Gate Open Area w/o Debris =	11.81	N/A	ft ²
Overflow Gate Open Area w/ Debris =	11.81	N/A	ft ²

User Input: Outlet Pipe w/ Flow Restriction Plate (Circular Orifice, Restrictor Plate, or Rectangular Orifice)

	Zone 3 Circular	Not Selected	
Depth to Invert of Outlet Pipe =	2.25	N/A	ft (distance below basin bottom at Stage = 0 ft)
Circular Orifice Diameter =	5.00	N/A	inches

	Zone 3 Circular	Not Selected	
Outlet Orifice Area =	0.14	N/A	ft ²
Outlet Orifice Centroid =	0.21	N/A	feet
Half-Central Angle of Restrictor Plate on Pipe =	N/A	N/A	radians

User Input: Emergency Spillway (Rectangular or Trapezoidal)

Spillway Invert Stage =	0.60	ft (relative to basin bottom at Stage = 0 ft)
Spillway Crest Length =	1.00	feet
Spillway End Slopes =	4.00	H:V
Freeboard above Max Water Surface =	1.00	feet

Spillway Design Flow Depth =	0.36	feet
Stage at Top of Freeboard =	1.96	feet
Basin Area at Top of Freeboard =	0.07	acres
Basin Volume at Top of Freeboard =	0.11	acre-ft

Routed Hydrograph Results

The user can override the default CUHP hydrographs and runoff volumes by entering new values in the Inflow Hydrographs table (Columns W through AF).

	WQCV	EURV	2 Year	5 Year	10 Year	25 Year	50 Year	100 Year	500 Year
Design Storm Return Period =									
One-Hour Rainfall Depth (in) =	0.53	1.07	0.69	0.98	1.23	1.58	1.86	2.14	2.84
CUHP Runoff Volume (acre-ft) =	0.020	0.058	0.028	0.048	0.076	0.134	0.174	0.222	0.330
Inflow Hydrograph Volume (acre-ft) =	0.004	0.011	0.006	0.010	0.015	0.027	0.035	0.044	0.066
CUHP Predevelopment Peak Q (cfs) =	0.0	0.0	0.0	0.0	0.1	0.4	0.6	0.8	1.3
OPTIONAL Override Predevelopment Peak Q (cfs) =	0.0	0.0							
Predevelopment Unit Peak Flow, q (cfs/acre) =	0.00	0.00	0.00	0.01	0.07	0.23	0.33	0.47	0.75
Peak Inflow Q (cfs) =	0.1	0.3	0.1	0.3	0.4	0.8	1.1	1.4	2.1
Peak Outflow Q (cfs) =	0.004	0.025	0.0	0.0	0.1	0.2	0.5	0.75	1.2
Ratio Peak Outflow to Predevelopment Q =	N/A	N/A	N/A	1.5	0.4	0.5	0.8	0.9	0.9
Structure Controlling Flow =	Filtration Media	Vertical Orifice 1	Filtration Media	Vertical Orifice 1	Vertical Orifice 1	Overflow Weir 1	Overflow Weir 1	Overflow Weir 1	Spillway
Max Velocity through Gate 1 (fps) =	N/A	N/A	N/A	N/A	N/A	0.0	0.0	0.1	0.1
Max Velocity through Gate 2 (fps) =	N/A	N/A	N/A	N/A	N/A	N/A	N/A	N/A	N/A
Time to Drain 97% of Inflow Volume (hours) =	11	22	15	21	23	22	22	21	19
Time to Drain 99% of Inflow Volume (hours) =	13	23	17	22	24	24	24	23	23
Maximum Ponding Depth (ft) =	0.10	0.27	0.14	0.23	0.33	0.49	0.53	0.57	0.68
Area at Maximum Ponding Depth (acres) =	0.04	0.04	0.04	0.04	0.04	0.04	0.05	0.05	0.05
Maximum Volume Stored (acre-ft) =	0.003	0.010	0.005	0.009	0.013	0.020	0.022	0.024	0.029

DETENTION BASIN OUTLET STRUCTURE DESIGN

MHFD-Detention, Version 4.00 (December 2019)

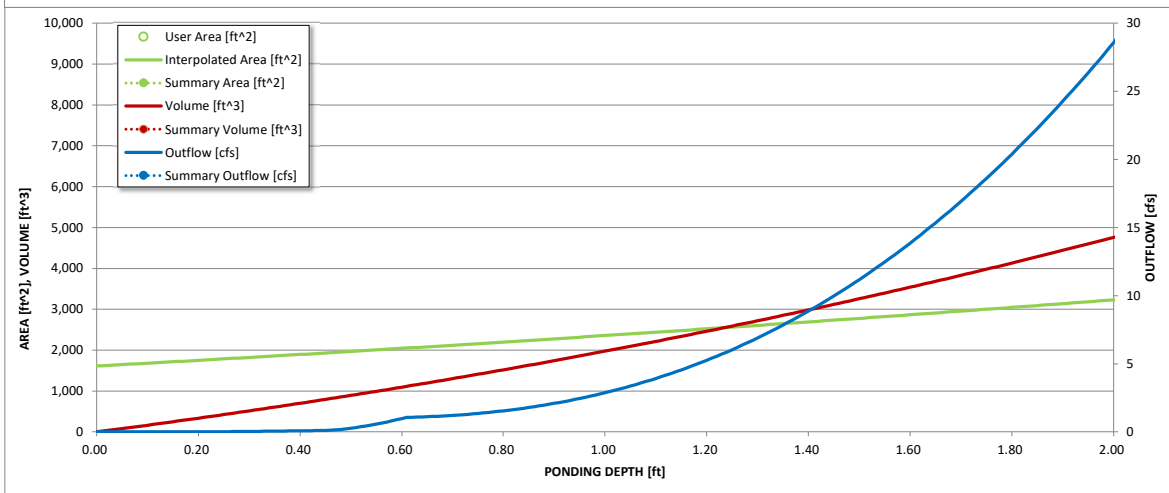
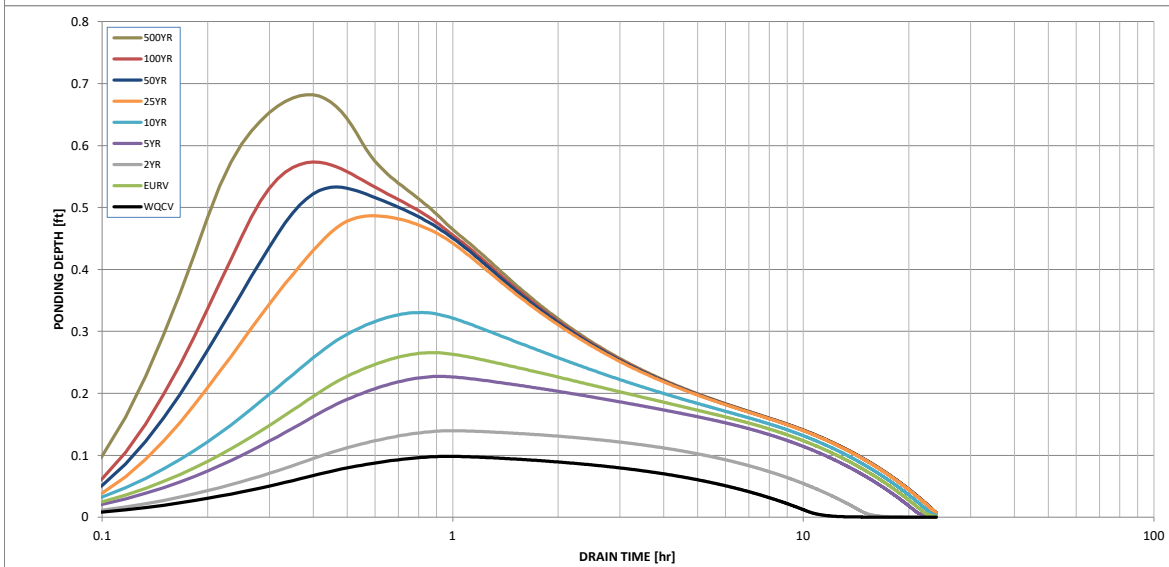
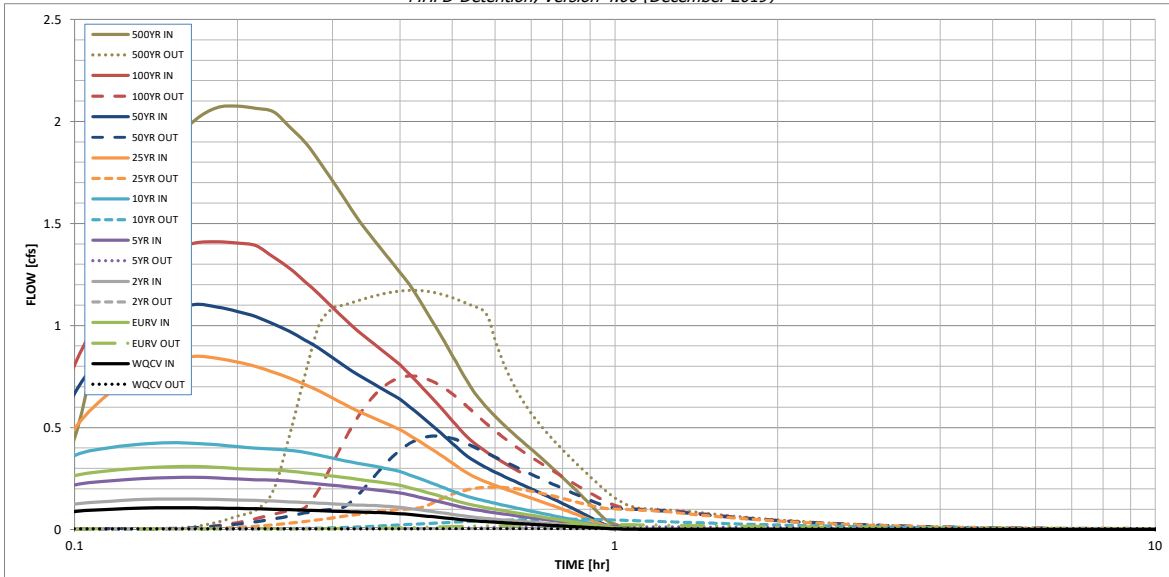

S-A-V-D Chart Axis Override	X-axis	Left Y-Axis	Right Y-Axis
minimum bound			
maximum bound			

GRASS SWALE CALCULATIONS
Widefield Water and Sanitation District
Rolling Hills Tank

Proposed Grass Swale (typ.), Subbasin C Open Channel Flow Evaluation

Manning's Formula

$$Q = (1.486/n)AR_h^{2/3}S^{1/2}$$

$$Q = V \cdot A$$

Q=Discharge, cfs

R=Hydraulic Radius, A/P, ft

A=cross sectional area, ft²

P=wetter perimeter, ft

S=slope of channel

n=Manning's roughness coefficient

z=sideslope

d=Depth, ft

b=Bottom Width, ft

n (grass)=	0.033	Mannings coeff
S=	0.01	in/in
b=	1.0	ft
d=	0.75	ft
z=	3.0	
z=	3.0	

					Solution to Manning's Equation	
Depth, ft	Area, ft ²	Wetted	Hydraulic	Top	Velocity ft/s	Flow cfs
		Perimeter , ft	Radius, ft	Width Width, ft		
0.75	2.44	5.74	0.42	5.50	2.79	6.79

GRASS SWALE CALCULATIONS
Widefield Water and Sanitation District
Rolling Hills Tank

Proposed Grass Swale (typ.), Subbasin D Open Channel Flow Evaluation

Manning's Formula

$$Q = (1.486/n)AR_h^{2/3}S^{1/2}$$

$$Q = V \cdot A$$

Q=Discharge, cfs

R=Hydraulic Radius, A/P, ft

A=cross sectional area, ft²

P=wetter perimeter, ft

S=slope of channel

n=Manning's roughness coefficient

z=sideslope

d=Depth, ft

b=Bottom Width, ft

n (grass)= 0.033 Mannings coeff
 S= 0.02 in/in
 b= 1.0 ft
 d= 0.75 ft
 z= 3.0
 z= 3.0

					Solution to Manning's Equation	
Depth, ft	Area, ft ²	Wetted	Hydraulic	Top	Velocity ft/s	Flow cfs
		Perimeter , ft	Radius, ft	Width Width, ft		
0.75	2.44	5.74	0.42	5.50	3.60	8.77

Appendix E

HY-8 Culvert Analysis Report

Crossing Discharge Data

Discharge Selection Method: Specify Minimum, Design, and Maximum Flow

Minimum Flow: 0 cfs

Design Flow: 1.4 cfs

Maximum Flow: 3.49 cfs

Table 1 - Summary of Culvert Flows at Crossing: Subbasin D - Drennan Rd.

Headwater Elevation	Total Discharge (cfs)	Culvert 1 Discharge (cfs)	Roadway Discharge (cfs)	Iterations
5958.75	0.00	0.00	0.00	1
5959.22	0.35	0.35	0.00	1
5959.31	0.70	0.70	0.00	1
5959.38	1.05	1.05	0.00	1
5959.46	1.40	1.40	0.00	1
5959.55	1.75	1.75	0.00	1
5959.63	2.09	2.09	0.00	1
5959.71	2.44	2.44	0.00	1
5959.79	2.79	2.79	0.00	1
5959.86	3.14	3.14	0.00	1
5959.95	3.49	3.49	0.00	1
5961.25	7.12	7.12	0.00	Overtopping

Rating Curve Plot for Crossing: Subbasin D - Drennan Rd.

Total Rating Curve
Crossing: Subbasin D - Drennan Rd.

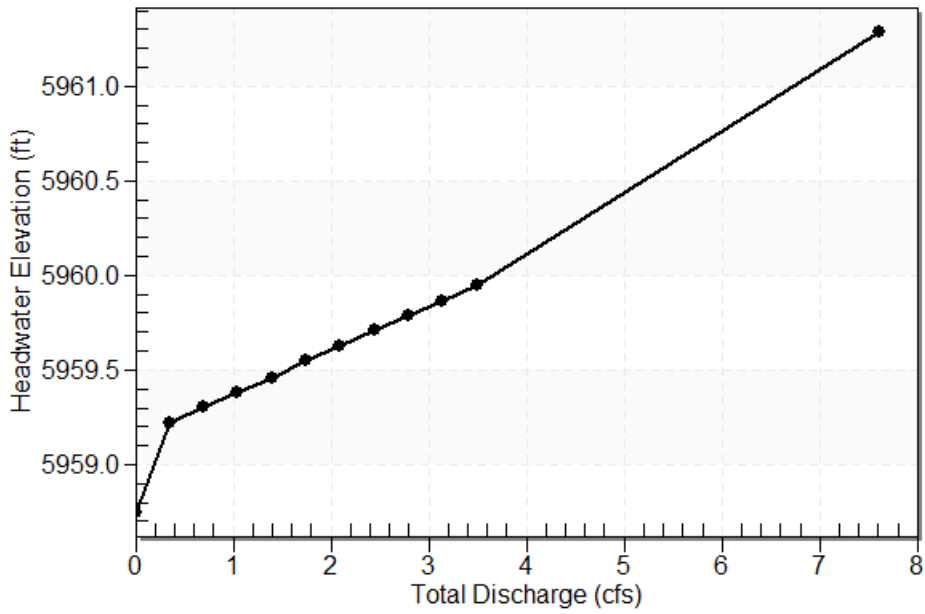

Table 2 - Culvert Summary Table: Culvert 1

Total Discharge (cfs)	Culvert Discharge (cfs)	Headwater Elevation (ft)	Inlet Control Depth (ft)	Outlet Control Depth (ft)	Flow Type	Normal Depth (ft)	Critical Depth (ft)	Outlet Depth (ft)	Tailwater Depth (ft)	Outlet Velocity (ft/s)	Tailwater Velocity (ft/s)
0.00	0.00	5958.74	0.000	0.000	0-NF	0.000	0.000	0.000	0.000	0.000	0.000
0.35	0.35	5959.21	0.466	0.0*	1-S2	0.193	0.229	0.193	0.030	2.907	1.097
0.70	0.70	5959.31	0.558	0.0*	1-S2	0.270	0.326	0.270	0.046	3.571	1.426
1.05	1.05	5959.38	0.635	0.0*	1-S2	0.332	0.402	0.332	0.058	4.014	1.654
1.40	1.40	5959.44	0.707	0.0*	1-S2	0.385	0.468	0.385	0.069	4.357	1.836
1.75	1.75	5959.51	0.797	0.0*	1-S2	0.432	0.525	0.432	0.078	4.636	1.985
2.09	2.09	5959.61	0.880	0.0*	1-S2	0.476	0.577	0.476	0.087	4.874	2.118
2.44	2.44	5959.71	0.958	0.077	1-S2	0.518	0.625	0.518	0.095	5.081	2.234
2.79	2.79	5959.79	1.035	0.184	1-S2	0.558	0.671	0.558	0.103	5.263	2.340
3.14	3.14	5959.86	1.114	0.297	1-S2	0.597	0.713	0.597	0.110	5.426	2.436
3.49	3.49	5959.94	1.196	0.415	1-S2	0.635	0.754	0.635	0.117	5.571	2.522

* Full Flow Headwater elevation is below inlet invert.

Straight Culvert

Inlet Elevation (invert): 5958.75 ft, Outlet Elevation (invert): 5958.00 ft

Culvert Length: 20.02 ft, Culvert Slope: 0.0375

Inlet Throat Elevation: 5958.75 ft, Inlet Crest Elevation: 5959.06 ft

Culvert Performance Curve Plot: Culvert 1

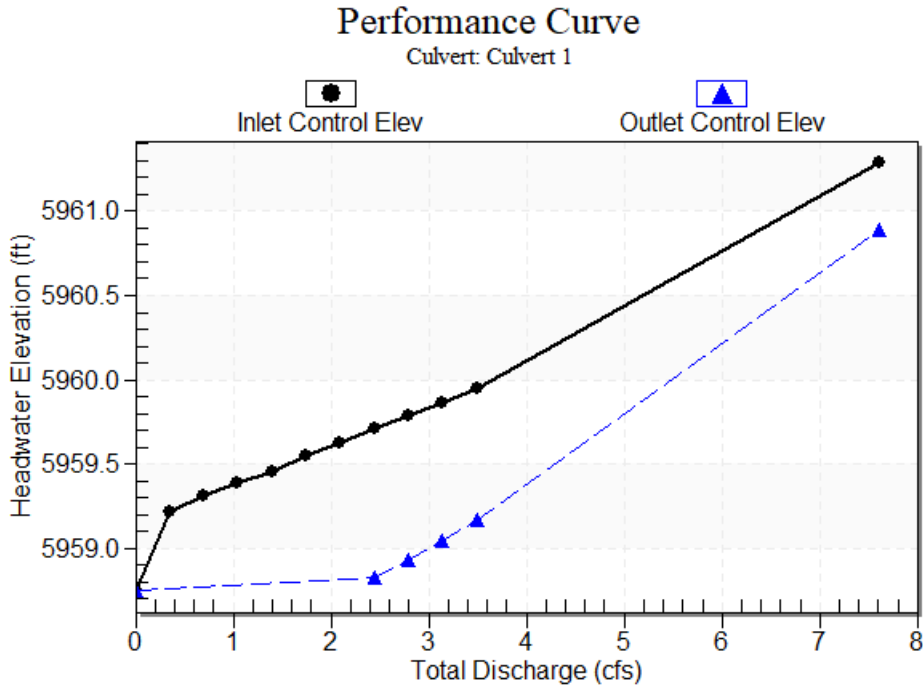

Water Surface Profile Plot for Culvert: Culvert 1

Crossing - Subbasin D - Drennan Rd., Design Discharge - 1.4 cfs

Culvert - Culvert 1, Culvert Discharge - 1.4 cfs

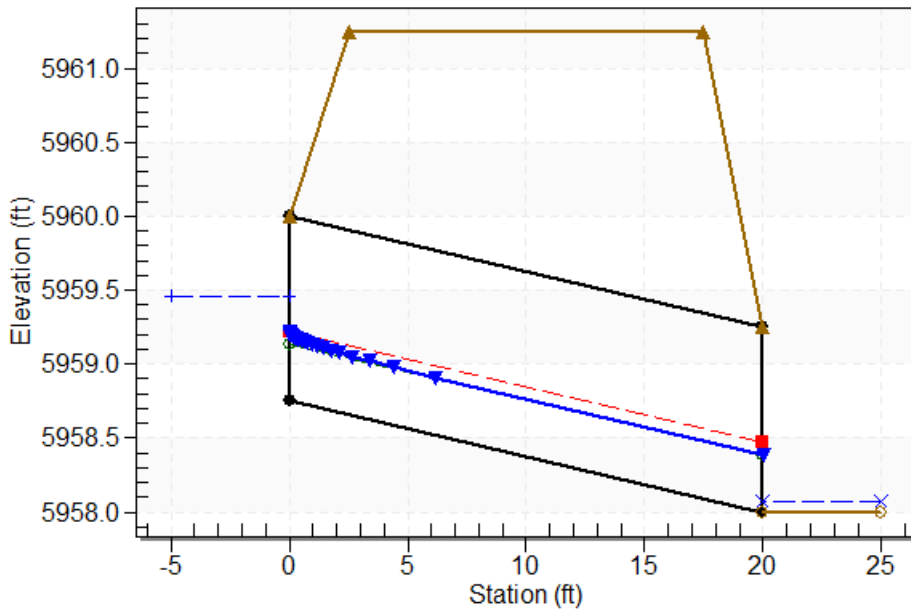

Site Data - Culvert 1

Site Data Option: Culvert Invert Data

Inlet Station: 0.00 ft

Inlet Elevation: 5959.00 ft

Outlet Station: 20.00 ft

Outlet Elevation: 5958.00 ft

Number of Barrels: 1

Culvert Data Summary - Culvert 1

Barrel Shape: Circular

Barrel Diameter: 1.25 ft

Barrel Material: Corrugated Steel

Embedment: 0.00 in

Barrel Manning's n: 0.0240

Culvert Type: Straight

Inlet Configuration: Mitered to Conform to Slope

Inlet Depression: Yes

Table 3 - Downstream Channel Rating Curve (Crossing: Subbasin D - Drennan

Flow (cfs)	Water Surface Elev (ft)	Depth (ft)	Velocity (ft/s)	Shear (psf)	Froude Number
0.00	5958.00	0.00	0.00	0.00	0.00
0.35	5958.03	0.03	1.10	0.13	1.14
0.70	5958.05	0.05	1.43	0.19	1.22
1.05	5958.06	0.06	1.65	0.24	1.26
1.40	5958.07	0.07	1.84	0.29	1.29
1.75	5958.08	0.08	1.98	0.33	1.32
2.09	5958.09	0.09	2.12	0.36	1.34
2.44	5958.09	0.09	2.23	0.40	1.36
2.79	5958.10	0.10	2.34	0.43	1.38
3.14	5958.11	0.11	2.44	0.46	1.39
3.49	5958.12	0.12	2.52	0.49	1.40

Tailwater Channel Data - Subbasin D - Drennan Rd.

Tailwater Channel Option: Trapezoidal Channel

Bottom Width: 10.00 ft

Side Slope (H:V): 16.00 (_:1)

Channel Slope: 0.0670

Channel Manning's n: 0.0330

Channel Invert Elevation: 5958.00 ft

Roadway Data for Crossing: Subbasin D - Drennan Rd.

Roadway Profile Shape: Constant Roadway Elevation

Crest Length: 20.00 ft

Crest Elevation: 5961.25 ft







Roadway Surface: Gravel





Roadway Top Width: 15.00 ft

Appendix F

2020/08/18 4:10 PM By: Shelby West J:\JDS-Hydro\Project Files\102 Widefield Water And San\102.121 Rolling Hills Tank\Drawings\Working\102.121_Drainage.dwg

LEGEND

-  EX CONTOURS—MAJOR
-  EX CONTOURS—MINOR
-  PP CONTOURS—MAJOR
-  PP CONTOURS—MINOR
-  PP FENCE
-  PP WATER LINE ALIGNMENT
-  FLOW PATH

-  PP FIRE HYDRANT
-  PP WATER VALVE
-  RIPRAP (FINAL)
-  PRE-DEVELOPED FLOW DIRECTION
-  DEVELOPED FLOW DIRECTION

-  SUBBASIN A
-  SUBBASIN B
-  SUBBASIN C
-  SUBBASIN D

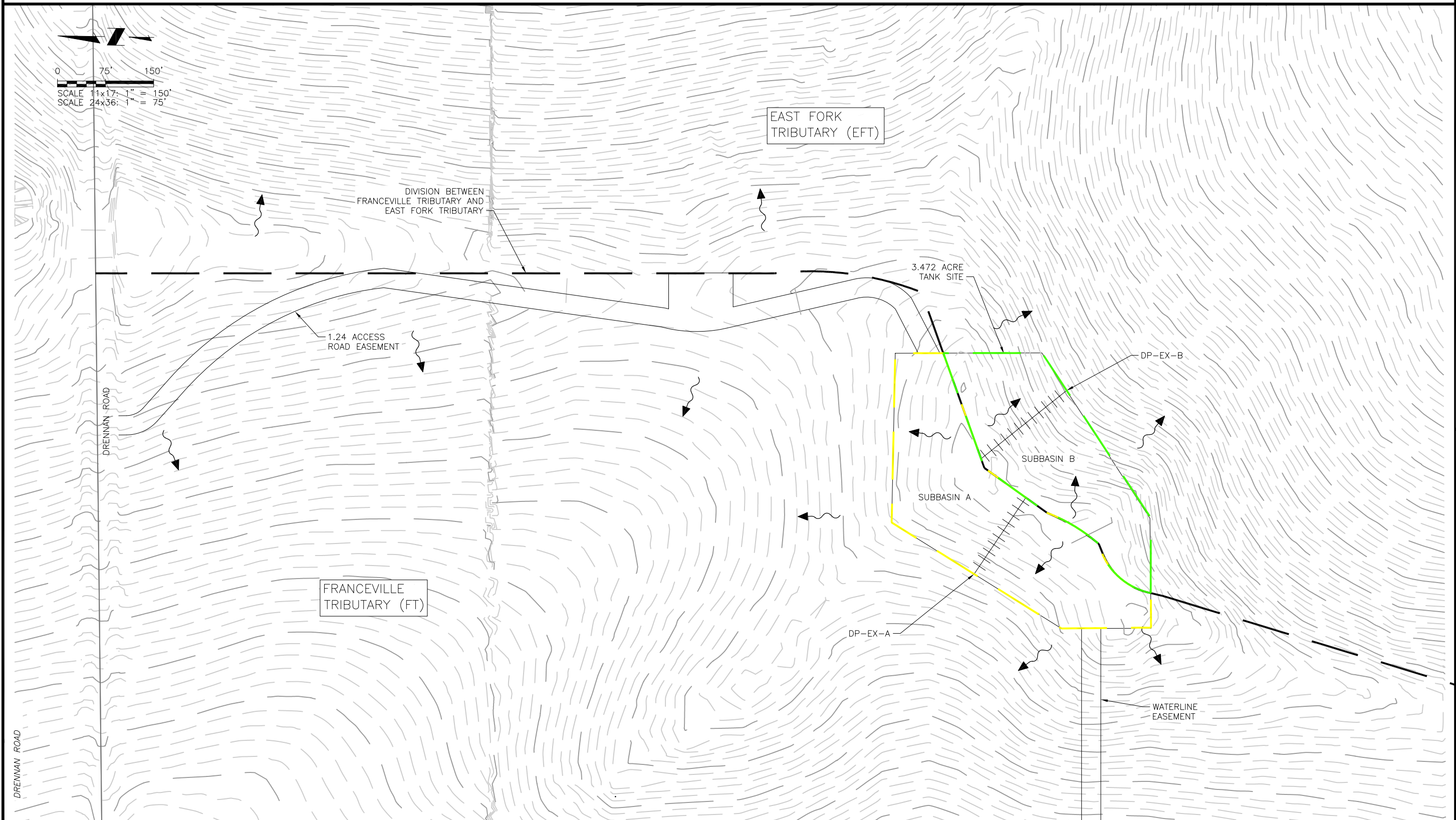
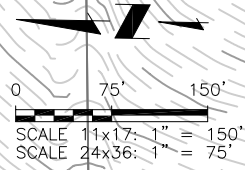

JDS-HYDRO CONSULTANTS, INC.
 5540 TECH CENTER DR., SUITE 100
 COLORADO SPRINGS, COLORADO 80919
 (719) 227-0072
DISCLAIMER: THE CONTRACTOR SHALL VERIFY ALL DIMENSIONS. ANY ERRORS OR OMISSIONS SHALL BE REPORTED TO JDS-HYDRO CONSULTANTS, INC. JDS-HYDRO ASSUMES NO LIABILITY FOR UNAUTHORIZED CHANGES AND/OR REVISIONS MADE TO PLANS.

WIDEFIELD WATER AND SANITATION DISTRICT
ROLLING HILLS 2MG POTABLE WATER TANK AND INLET PIPELINE
SITE DEVELOPMENT PLAN
EXISTING SITE DRAINAGE

NO.	DESCRIPTION	BY	APP.	DATE
1				
2				
3				
4				
5				
6				
7				

EXHIBIT
 Project No.: 102.121
 Date: 07/30/20
 Design: GJD
 Drawn: SNW
 Check: JPM
 SHEET ---- OF

LEGEND

- EX CONTOURS—MAJOR
- - - EX CONTOURS—MINOR
- PP CONTOURS—MAJOR
- - - PP CONTOURS—MINOR
- PP FENCE
- PP WATER LINE ALIGNMENT
- ||| FLOW LINE

- PP FIRE HYDRANT
- ⊗ PP WATER VALVE
- ▨ RIPRAP (FINAL)
- ~ PRE-DEVELOPED FLOW DIRECTION
- DEVELOPED FLOW DIRECTION

- SUBBASIN A
- SUBBASIN B
- SUBBASIN C
- SUBBASIN D

- ▨ GRAVEL ROAD
- ▨ RIPRAP

2020/08/18 4:11 PM By: Shelby West J:\JDS-Hydro\Project Files\102 Widefield Water And San\102.121 Rolling Hills Tank\Drawings\Working\102121_Drainage.dwg

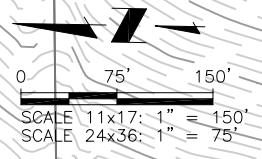

Please indicate how the flow at the drennan road roadside ditch (DP D) compares to the existing/historic flow at this location. Please state whether the flow due to development in basin D is of negligible increase.

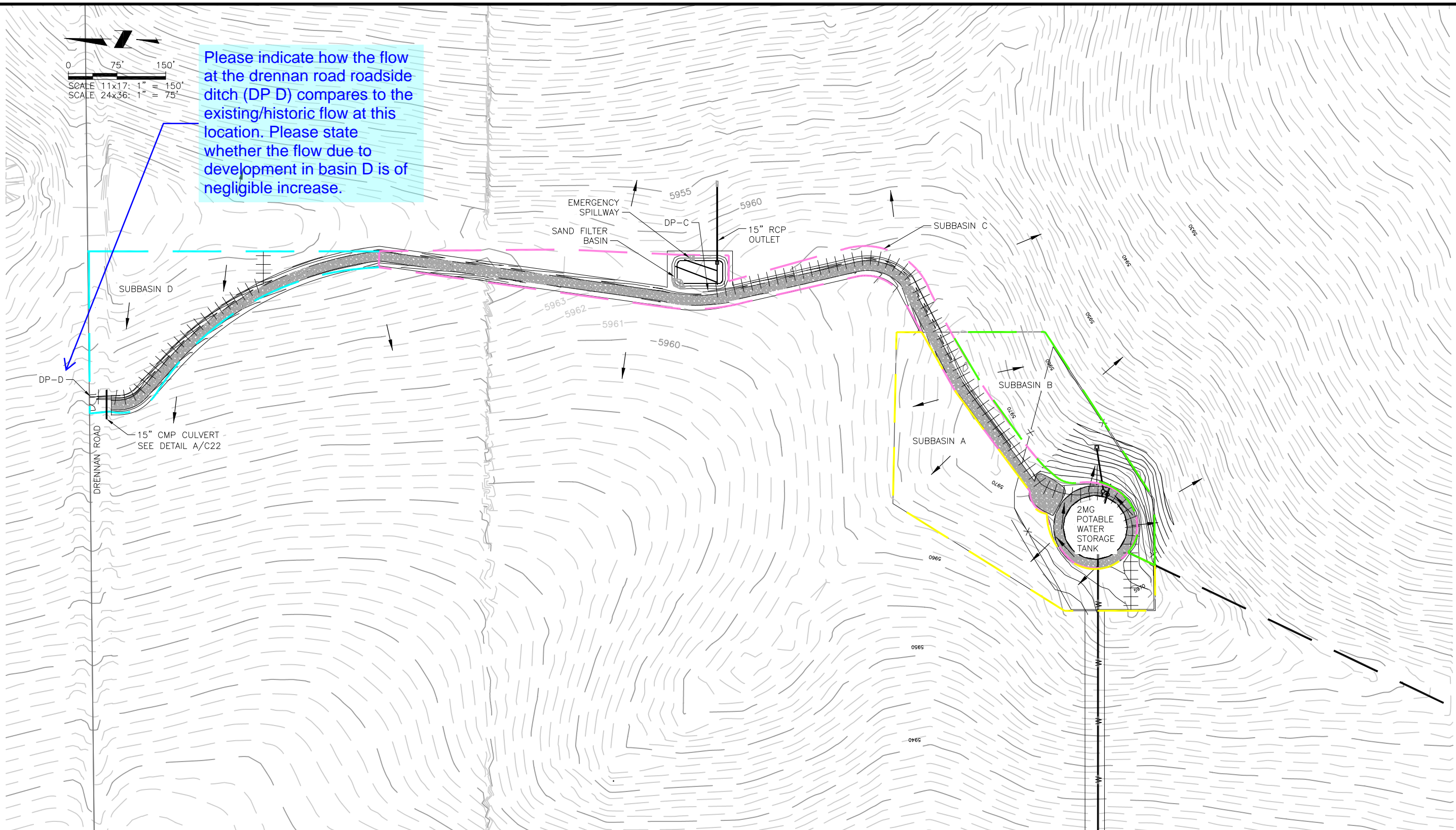

JDS-HYDRO CONSULTANTS, INC.
 5540 TECH CENTER DR., SUITE 100
 COLORADO SPRINGS, COLORADO 80919
 (719) 227-0072

DISCLAIMER: THE CONTRACTOR SHALL VERIFY ALL DIMENSIONS. ANY ERRORS OR OMISSIONS SHALL BE REPORTED TO JDS-HYDRO CONSULTANTS, INC. JDS-HYDRO ASSUMES NO LIABILITY FOR UNAUTHORIZED CHANGES AND/OR REVISIONS MADE TO PLANS.

WIDEFIELD WATER AND SANITATION DISTRICT
 ROLLING HILLS 2MG POTABLE WATER TANK AND INLET PIPELINE
 SITE DEVELOPMENT PLAN
 PROPOSED SITE DRAINAGE

NO.	DESCRIPTION	BY	APP.	DATE
1				
2				
3				
4				
5				
6				
7				

EXHIBIT

Project No.: 102.121
 Date: 07/30/20
 Design: GJD
 Drawn: SNW
 Check: JPM

SHEET ---- OF

2020/08/18 4:12 PM By: Shelby West J:\JDS-Hydro\Project Files\102 Widefield Water And San\102.121 Rolling Hills Tank\Drawings\Working\102.121_Drainage.dwg

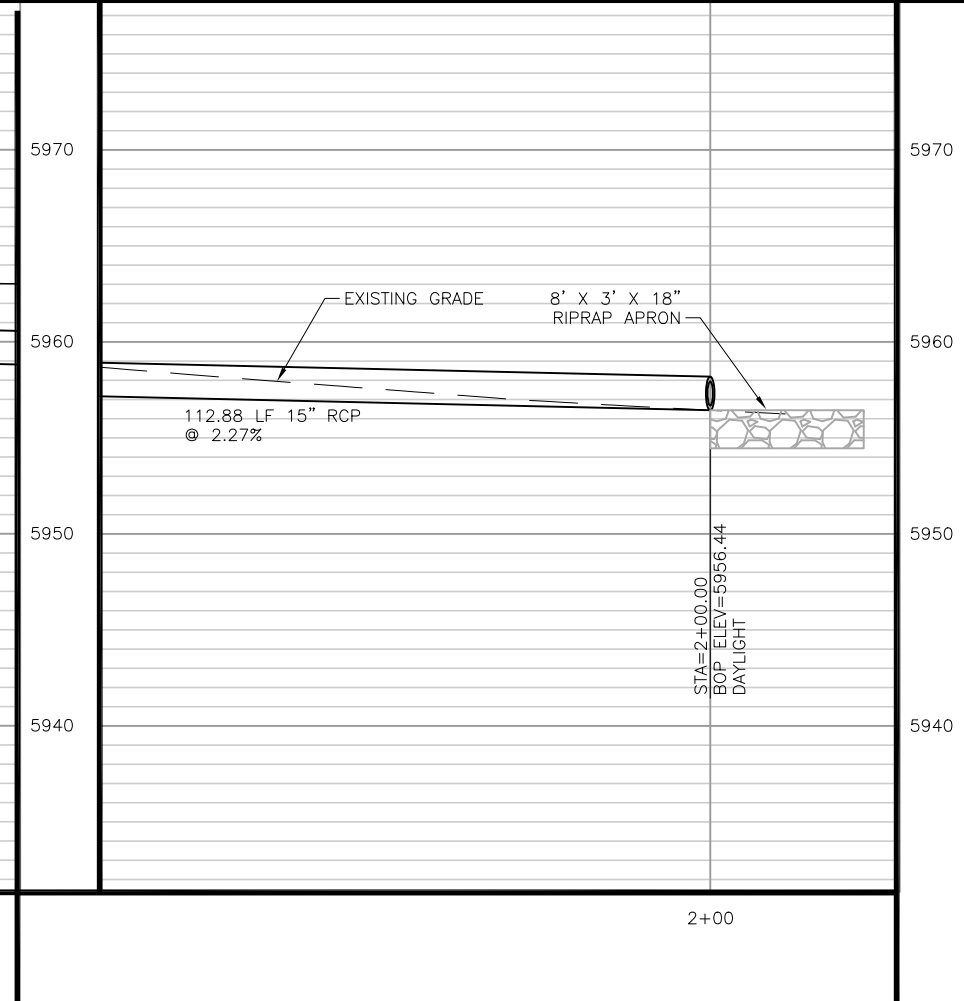
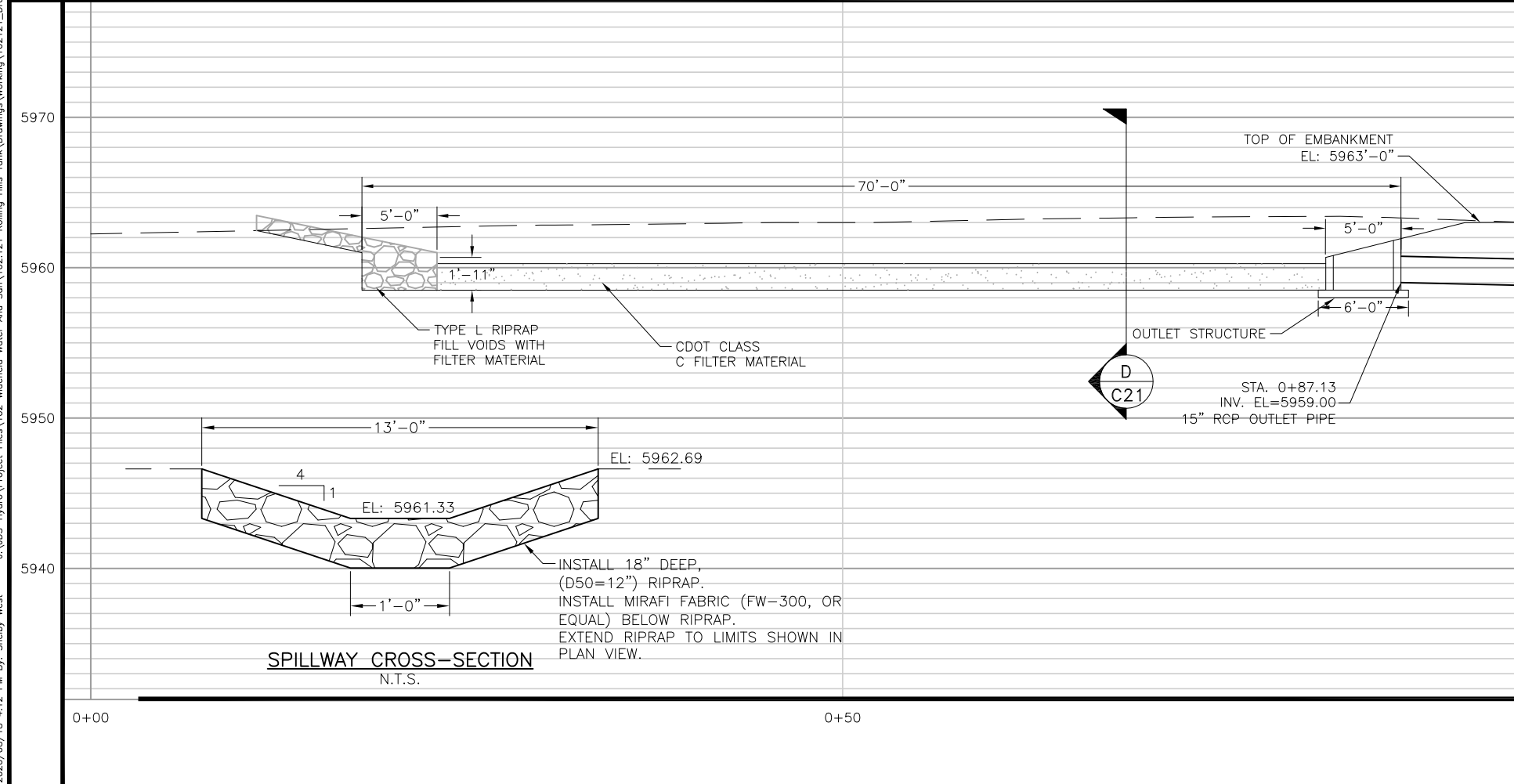
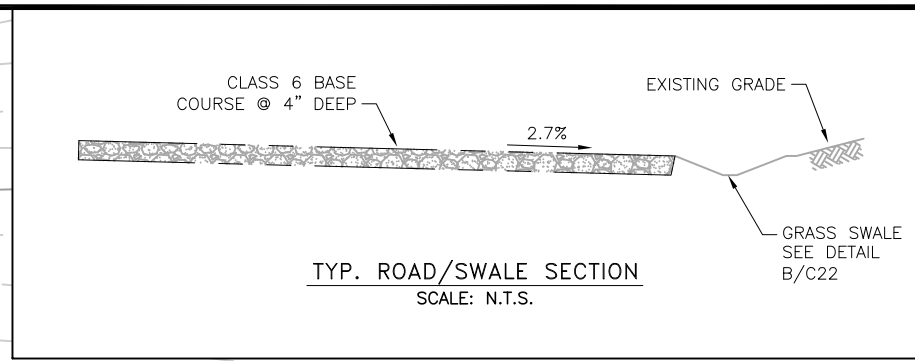
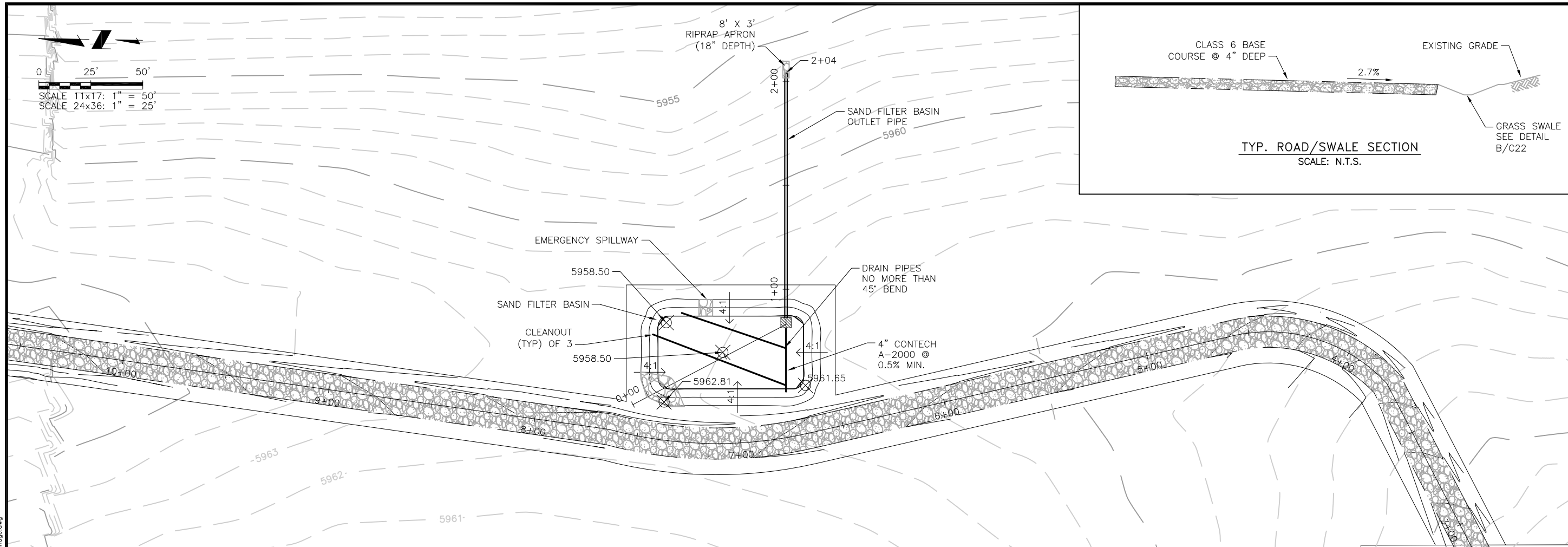

JDS-HYDRO CONSULTANTS, INC.
 5540 TECH CENTER DR., SUITE 100
 COLORADO SPRINGS, COLORADO 80919
 (719) 227-0072

DISCLAIMER: THE CONTRACTOR SHALL VERIFY ALL DIMENSIONS. ANY ERRORS OR OMISSIONS SHALL BE REPORTED TO JDS-HYDRO CONSULTANTS, INC. JDS-HYDRO ASSUMES NO LIABILITY FOR UNAUTHORIZED CHANGES AND/OR REVISIONS MADE TO PLANS.

WIDEFIELD WATER AND SANITATION DISTRICT
 ROLLING HILLS 2MG POTABLE WATER TANK AND INLET PIPELINE
 DRAINAGE BASIN PLAN & PROFILE

NO.	DESCRIPTION	BY	APP.	DATE
1				
2				
3				
4				
5				
6				
7				

EXHIBIT

Project No.: 102.121
 Date: 07/30/20
 Design: GJD
 Drawn: SNW
 Check: JPM

SHEET --- OF

2020/08/18 4:12 PM By: Shelby West J:\05-Hydro\Project Files\102 Widfield Water And San\102.121 Rolling Hills Tank\Drawings\Working\102121_Civil_Details.dwg

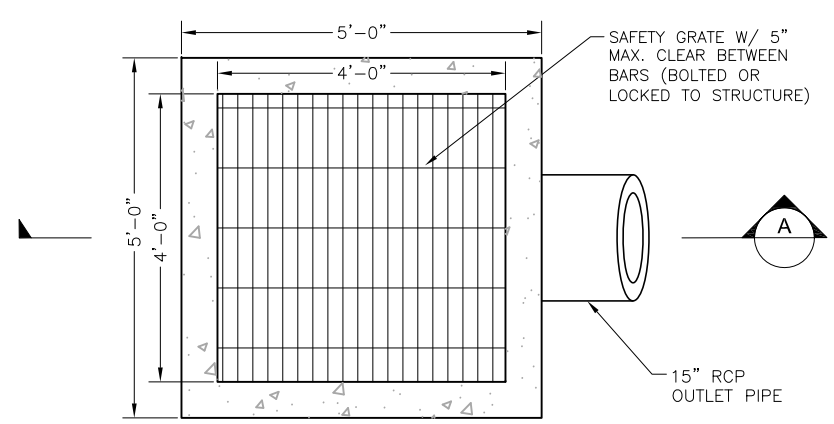

PLAN

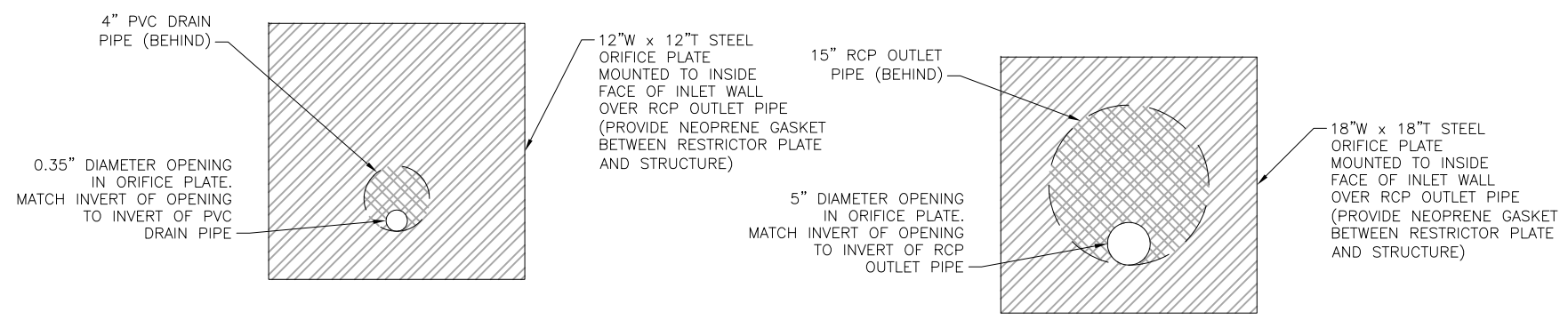

A ORIFICE PLATES
C21 SCALE: N.T.S.

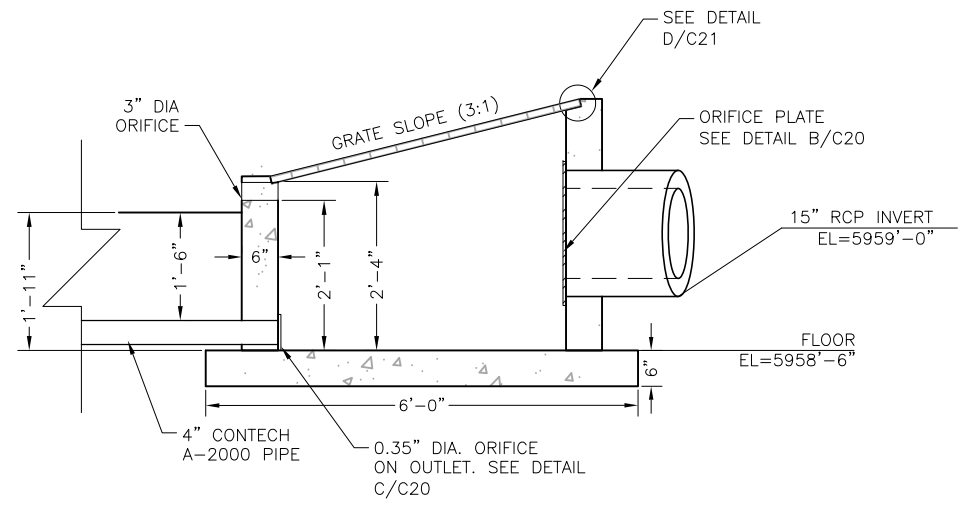

B OUTLET STRUCTURE
C21 SCALE: 3/8" = 1'-0"

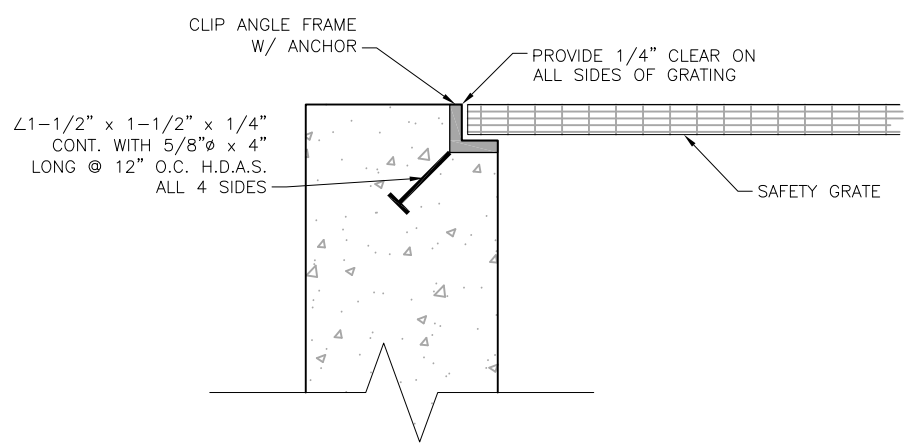

C GRATING DETAIL
C21 SCALE: N.T.S.

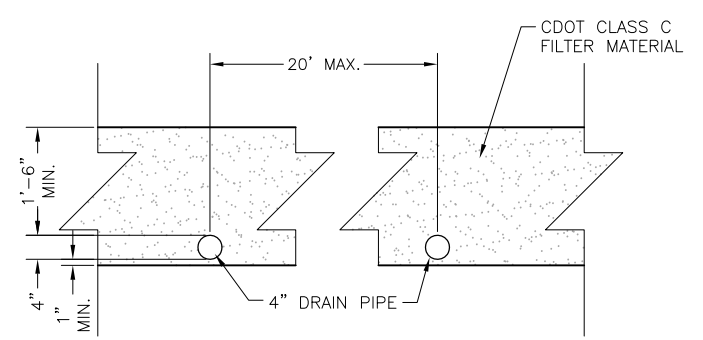

D DRAINAGE BASIN SECTION
C21 SCALE: 3/8" = 1'-0"

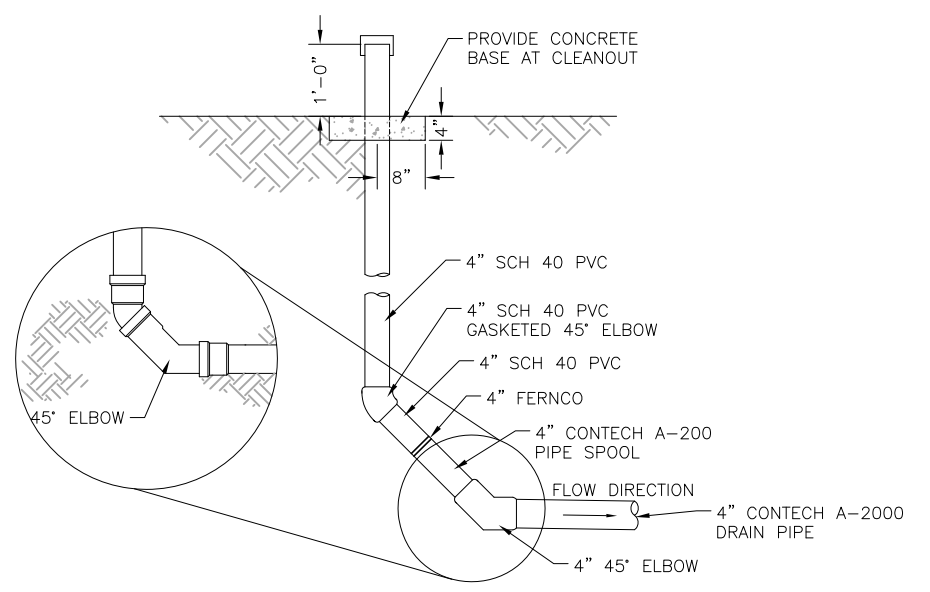

E CLEANOUT
C21 SCALE: N.T.S.

JDS-HYDRO CONSULTANTS, INC.
5640 TECH CENTER DR., SUITE 100
COLORADO SPRINGS, COLORADO 80919
(719) 227-0072
DISCLAIMER: THE CONTRACTOR SHALL VERIFY ALL DIMENSIONS. ANY ERRORS OR OMISSIONS SHALL BE REPORTED TO JDS-HYDRO CONSULTANTS, INC. JDS-HYDRO ASSUMES NO LIABILITY FOR UNAUTHORIZED CHANGES AND/OR REVISIONS MADE TO PLANS.

WIDFIELD WATER AND SANITATION DISTRICT
ROLLING HILLS 2MG POTABLE WATER TANK AND INLET PIPELINE
CIVIL DETAILS

NO.	DESCRIPTION	BY	APP.	DATE
1				
2				
3				
4				
5				
6				
7				

80% DESIGN

Project No.: 102.121
Date: 08/07/20
Design: GJD
Drawn: SNW
Check: JPM

2020/08/18 4:12 PM By: Shelby West J:_JDS-Hydro\Project Files\102 Widefield Water And San\102.121 Rolling Hills Tank\Drawings\Working\102121_Civil_Details.dwg

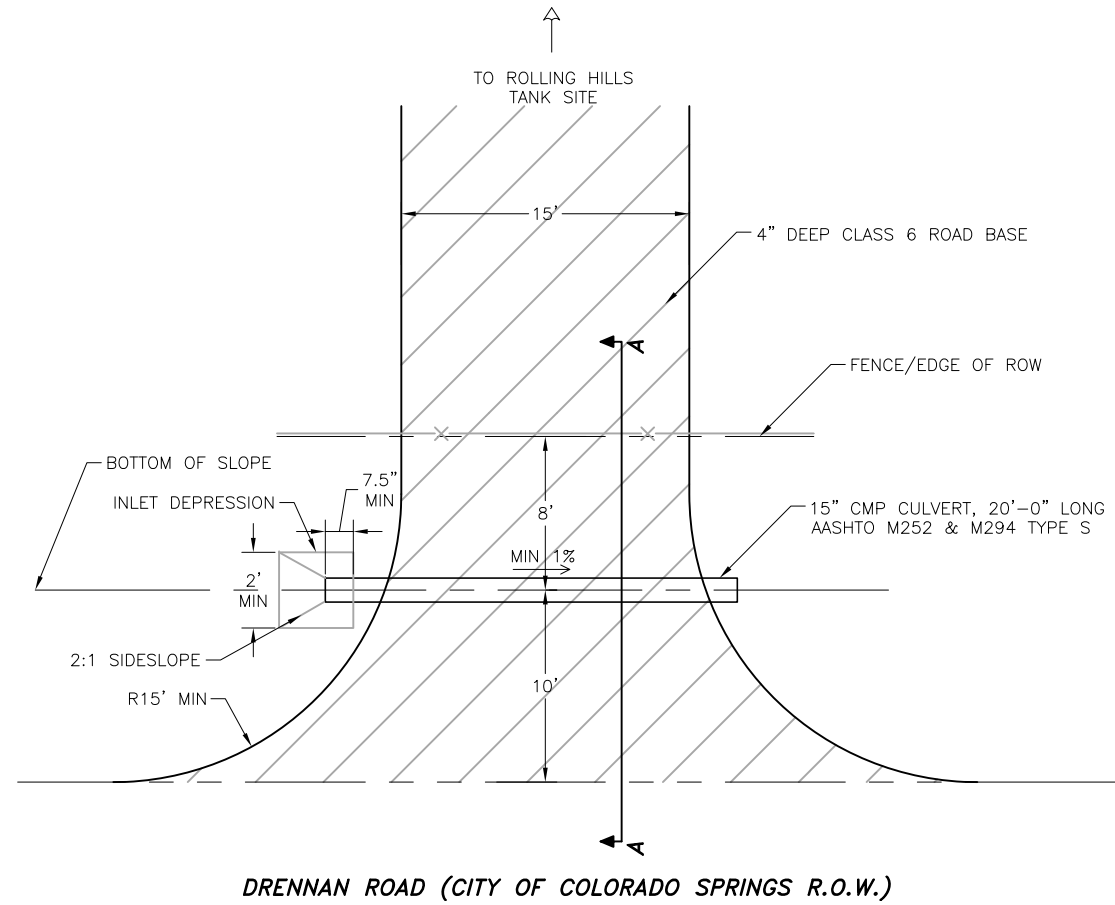

DRENNAN ROAD (CITY OF COLORADO SPRINGS R.O.W.)

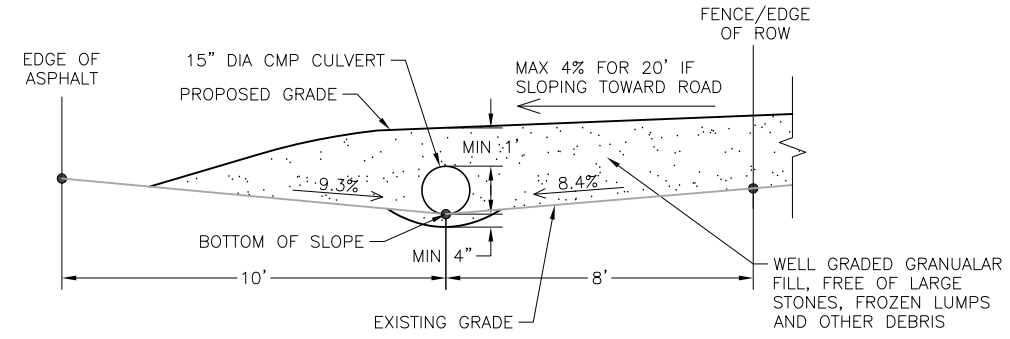

SECTION A-A
SCALE: N.T.S.

- NOTES:**
1. SURFACE TREATMENT OF DRIVEWAY TO BE CLASS 6 ROAD BASE AT 4" DEEP.
 2. DRAIN PIPE TO BE 15" DIAMETER MIN.
 3. PIPE SLOPE TO BE CONSISTANT WITH FLOW LINE OF DITCH, MINIMUM OF 1%.
 4. BACKFILL TO BE PLACED IN 6" LAYERS, DEPOSITED AND COMPACTED ON ALTERNATING SIDES OF THE PIPE.
 5. MEASUREMENTS ARE APPROXIMATE AND SHOULD BE FIELD VERIFIED PRIOR TO COMMENCING CONSTRUCTION.

A
C22 DRIVEWAY ACCESS ROAD
SCALE: N.T.S.

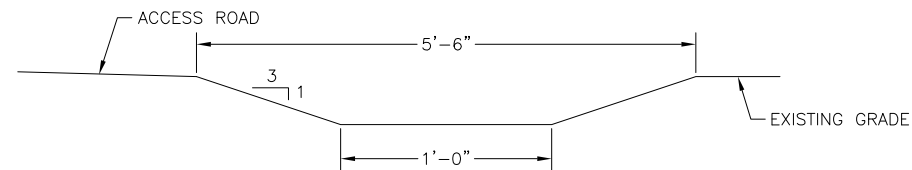

B
C22 TYPICAL GRASS SWALE SECTION
SCALE: N.T.S.

JDS-HYDRO CONSULTANTS, INC.
5640 TECH CENTER DR., SUITE 100
COLORADO SPRINGS, COLORADO 80919
(719) 227-0072

DISCLAIMER: THE CONTRACTOR SHALL VERIFY ALL DIMENSIONS. ANY ERRORS OR OMISSIONS SHALL BE REPORTED TO JDS-HYDRO CONSULTANTS, INC. JDS-HYDRO ASSUMES NO LIABILITY FOR UNAUTHORIZED CHANGES AND/OR REVISIONS MADE TO PLANS.

WIDEFIELD WATER AND SANITATION DISTRICT
ROLLING HILLS 2MG POTABLE WATER TANK AND INLET PIPELINE
CIVIL DETAILS

NO.	DESCRIPTION	BY	APP.	DATE
1				
2				
3				
4				
5				
6				
7				

80% DESIGN

Project No.: 102.121
Date: 08/07/20
Design: GJD
Drawn: SNW
Check: JPM