

**PLANT SCHEDULE**

DECIDUOUS TREES	CODE	QTY	BOTANICAL / COMMON NAME	CONT. SIZE	SIZE/CAL.	WIDTH	HEIGHT
CO	4		CELTIS OCCIDENTALIS / COMMON HACKBERRY	B & B	1.5" CAL MIN	40'-50"	40'-50"
EVERGREEN TREES	CODE	QTY	BOTANICAL / COMMON NAME	CONT. SIZE	SIZE/CAL.	WIDTH	HEIGHT
PE	15		PINUS CEMROIDES EDULIS / PINYON PINE	B & B	1.5" CAL MIN	10'-30"	10'-25"
PP	9		PINUS PONDEROSA / PONDEROSA PINE	B & B	1.5" CAL MIN	20'-30"	50'-60"
DECIDUOUS SHRUBS	CODE	QTY	BOTANICAL / COMMON NAME	CONT. SIZE	SPACING	WIDTH	HEIGHT
BC	13		BERBERIS THUNBERGII / CRIMSON PYGMY / CRIMSON PYGMY JAPANESE BARBERRY	5 GAL	SEE PLAN	2'-3"	1'-2"
PA	20		PEROVSKIA ABROTANOIDES / RUSSIAN SAGE	5 GAL	SEE PLAN	3'-5"	3'-5"
RA	3		RIBES ALPINUM / ALPINE CURRANT	5 GAL	SEE PLAN	3'-6"	3'-6"
VA	4		VIBURNUM X RHYTIPOHYLLOIDES / LANTANAPHYLLUM VIBURNUM	5 GAL	SEE PLAN	6'-10"	6'-10"
EVERGREEN SHRUBS	CODE	QTY	BOTANICAL / COMMON NAME	CONT. SIZE	SPACING	WIDTH	HEIGHT
JH	21		JUNIPERUS HORIZONTALIS / CREEPING JUNIPER	5 GAL	SEE PLAN	6'-8"	8'-12"
PM	5		PINUS MUGO 'MOPS' / MOPS MUGO PINE	5 GAL	SEE PLAN	2'-3"	2'-3"
GRASSES	CODE	QTY	BOTANICAL / COMMON NAME	CONT. SIZE	SPACING	WIDTH	HEIGHT
BB	5		BOUTELOUA GRACILIS 'BLONDE AMBITION' / BLONDE AMBITION BLUE GRAMA	5 GAL	SEE PLAN	2'-3"	2'-3"
HS	38		HELICTOTRICHON SEMPERVIRENS / BLUE OAT GRASS	5 GAL	SEE PLAN	2'-4"	2'-4"
PERENNIALS	CODE	QTY	BOTANICAL / COMMON NAME	CONT. SIZE	SPACING	WIDTH	HEIGHT
AC	8		AGASTACHE CANA / TEXAS HUMMINGBIRD MINT	5 GAL	SEE PLAN	12'-15"	12'-18"
AW	12		ASTER DUMOSUS 'WOOD'S LIGHT BLUE' / WOOD'S LIGHT BLUE ASTER	5 GAL	SEE PLAN	12'-18"	12'-15"
RM	17		RUBEOIDIA PURPUREA / PURPLE CONEFLOWER	5 GAL	SEE PLAN	2'-4"	2'-4"
GROUND COVERS	CODE	QTY	BOTANICAL / COMMON NAME	TYPE	INSTALL RATE	WEED FABRIC	MFR
ROCK	8,076 SF		1-1/2" ROCK MULCH SUBMIT SAMPLE FOR REVIEW AND APPROVAL PRIOR TO INSTALLATION.	ROCK MULCH	4"	YES	
ROCK2	2,396 SF		3/8" ROCK MULCH SUBMIT SAMPLE FOR REVIEW AND APPROVAL PRIOR TO INSTALLATION.	ROCK MULCH	4"	YES	
SEED2	150,949 SF		EPC LOW GROW MIX INSTALL PER TABLE 5-2. SUBMIT SUPPLIER CUT-SHEET FOR REVIEW AND APPROVAL PRIOR TO INSTALLATION.	SEED	PER CHART		PAWNEE BUTTES SEED
SEED3	270,152 SF		EPC ALL PURPOSE MIX INSTALL PER TABLE 5-1. SUBMIT SUPPLIER CUT-SHEET FOR REVIEW AND APPROVAL PRIOR TO INSTALLATION.	SEED	PER CHART		
SOD	41,585 SF		POA PRATENSIS / KENTUCKY BLUEGRASS (BID ALTERNATE #4) INSTALL PER DETAIL.	SOD			GREEN BELT TURF
BOUL	19		DECORATIVE LANDSCAPE BOULDERS. COLOR BY OWNER. UTILIZE ON-SITE MATERIAL IF AVAILABLE.				

Table 5-1. El Paso County Conservation District All-Purpose Mix for Upland, Transition and Permanent Control Measure Areas

Common Name	Scientific Name	Growth Season / Form	% of Mix	Pounds PLS		
				Irrigated broadcast hydroseeded	Non-irrigated broadcast hydroseeded	Non-irrigated drilled
				80 seeds/sq ft	40 seeds/sq ft	20 seeds/sq ft
Bluestem, big	<i>Andropogon gerardii</i>	Warm, sod	20	4.4	2.2	1.1
Grama, blue	<i>Bouteloua gracilis</i>	Warm, bunch	10	0.5	0.25	0.13
Green needlegrass	<i>Nassella viridula</i>	Cool, bunch	10	2	1	0.5
Wheatgrass, western	<i>Pascopyrum smithii</i>	Cool, sod	20	6.4	3.2	1.6
Grama, sideoats	<i>Bouteloua curtipendula</i>	Warm, bunch	10	2	1	0.5
Switchgrass	<i>Panicum virgatum</i>	Warm, bunch/sod	10	0.8	0.4	0.2
Prairie sandreed	<i>Calamovilfa longifolia</i>	Warm, sod	10	1.2	0.6	0.3
Yellow indiagrass	<i>Sorghastrum nutans</i>	Warm, sod	10	2	1	0.5
Seed rate (lbs PLS/acre)				19.3	9.7	4.8

Table 5-2. El Paso County All-Purpose Low Grow Mix for Upland and Transition Areas

Common Name	Scientific Name	Growth Season / Form	% of Mix	Pounds PLS		
				Irrigated broadcast hydroseeded	Non-irrigated broadcast hydroseeded	Non-irrigated drilled
				80 seeds/sq ft	40 seeds/sq ft	20 seeds/sq ft
Buffalograss	<i>Buchloe dactyloides</i>	Warm, sod	25	9.6	4.8	2.4
Grama, blue	<i>Bouteloua gracilis</i>	Warm, bunch	20	10.8	5.4	2.7
Grama, sideoats	<i>Bouteloua curtipendula</i>	Warm, bunch	29	5.6	2.8	1.4
Green needlegrass	<i>Nassella viridula</i>	Cool, bunch	5	3.2	1.6	0.8
Wheatgrass, western	<i>Pascopyrum smithii</i>	Cool, sod	20	12	6	3
Dropsseed, sand	<i>Sporobolus cryptandrus</i>	Warm, bunch	1	0.8	0.4	0.2
Seed rate (lbs PLS/acre)				42	21	10.3

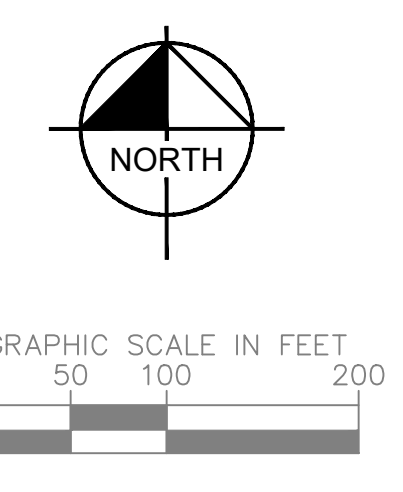



### PLANT SCHEDULE

DECIDUOUS TREES	CODE	QTY	BOTANICAL / COMMON NAME
	CO	4	CELTIS OCCIDENTALIS / COMMON HACKBERRY
EVERGREEN TREES	CODE	QTY	BOTANICAL / COMMON NAME
	PE	15	PINUS CEMEROIDES EDULIS / PINYON PINE
	PP	9	PINUS PONDEROSA / PONDEROSA PINE
DECIDUOUS SHRUBS	CODE	QTY	BOTANICAL / COMMON NAME
	BC	13	BERBERIS THUNBERGII 'CRIMSON PYGMY' / CRIMSON PYGMY JAPANESE BARBERRY
	PA	20	PEROVSKIA ABROTANOIDES / RUSSIAN SAGE
	RA	3	RIBES ALPINUM / ALPINE CURRANT
	VA	4	VIBURNUM X RHYTIDOPHYLLOIDES / LANTANAPHYLLUM VIBURNUM
EVERGREEN SHRUBS	CODE	QTY	BOTANICAL / COMMON NAME
	JH	21	JUNIPERUS HORIZONTALIS / CREEPING JUNIPER
	PM	5	PINUS MUGO 'MOPS' / MOPS MUGO PINE
GRASSES	CODE	QTY	BOTANICAL / COMMON NAME
	BB	5	BOUTELOUA GRACILIS 'BLONDE AMBITION' / BLONDE AMBITION BLUE GRAMA
	HS	38	HELICTOTRICHON SEMPERVIRENS / BLUE OAT GRASS
PERENNIALS	CODE	QTY	BOTANICAL / COMMON NAME
	AC	8	AGASTACHE CANA / TEXAS HUMMINGBIRD MINT
	AW	12	ASTER DUMOSUS 'WOOD'S LIGHT BLUE' / WOOD'S LIGHT BLUE ASTER
	RM	17	RUDBECKIA PURPUREA / PURPLE CONEFLOWER
GROUND COVERS	CODE	QTY	BOTANICAL / COMMON NAME
	ROCK	8,076 SF	1-1/2\"/>

**D49 TRANSPORTATION CENTER**

**SCHOOL DISTRICT NO 49**  
 11971 SWINGLINE ROAD  
 PEYTON, CO 80831

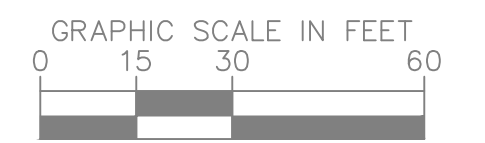
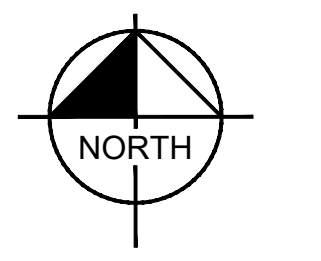

BIM 380 / 2021-041.00 D49 Transportation Center / 2021-041.00 D49 Transportation Center.rvt  
 1/7/2022 3:03:16 PM



**Landscape Plan**

DATE PROJECT NUMBER  
**2021-041.00**  
 DATE  
**05/23/2022**

#	DATE	DESCRIPTION
1	06/29/2022	ADD IT

DESIGNED BY: JH  
 DRAWN BY: AK  
 CHECKED BY: SB

ISSUED FOR:  
**CONSTRUCTION DOCUMENTS**

SHEET NO.  
**L-100**



**PLANT SCHEDULE**

DECIDUOUS TREES	CODE	QTY	BOTANICAL / COMMON NAME
	CO	4	CELTIS OCCIDENTALIS / COMMON HACKBERRY
<b>EVERGREEN TREES</b>	<b>CODE</b>	<b>QTY</b>	<b>BOTANICAL / COMMON NAME</b>
	PE	15	PINUS CEMBOIDES EDULIS / PINYON PINE
	PP	9	PINUS PONDEROSA / PONDEROSA PINE
<b>DECIDUOUS SHRUBS</b>	<b>CODE</b>	<b>QTY</b>	<b>BOTANICAL / COMMON NAME</b>
	BC	13	BERBERIS THUNBERGII 'CRIMSON PYGMY' / CRIMSON PYGMY JAPANESE BARBERRY
	PA	20	PEROVSKIA ABROTANOIDES / RUSSIAN SAGE
	RA	3	RIBES ALPINUM / ALPINE CURRANT
	VA	4	VIBURNUM X RHYTIDOPHYLLOIDES / LANTANAPHYLLUM VIBURNUM
<b>EVERGREEN SHRUBS</b>	<b>CODE</b>	<b>QTY</b>	<b>BOTANICAL / COMMON NAME</b>
	JH	21	JUNIPERUS HORIZONTALIS / CREEPING JUNIPER
	PM	5	PINUS MUGO 'MOPS' / MOPS MUGO PINE
<b>GRASSES</b>	<b>CODE</b>	<b>QTY</b>	<b>BOTANICAL / COMMON NAME</b>
	BB	5	BOUTELOUA GRACILIS 'BLONDE AMBITION' / BLONDE AMBITION BLUE GRAMA
	HS	38	HELICTOTRICHON SEMPERVIRENS / BLUE OAT GRASS
<b>PERENNIALS</b>	<b>CODE</b>	<b>QTY</b>	<b>BOTANICAL / COMMON NAME</b>
	AC	8	AGASTACHE CANA / TEXAS HUMMINGBIRD MINT
	AW	12	ASTER DIMOSUS 'WOOD'S LIGHT BLUE' / WOOD'S LIGHT BLUE ASTER
	RM	17	RUDEBECKIA PURPUREA / PURPLE CONEFLOWER
<b>GROUND COVERS</b>	<b>CODE</b>	<b>QTY</b>	<b>BOTANICAL / COMMON NAME</b>
	ROCK	8,076 SF	1-1/2\"/>

430000017  
DIOCESE OF COLORADO SPRINGS  
12150 FALCON HWY  
ZONE RRR-5

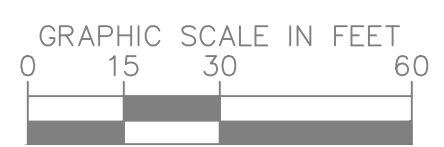
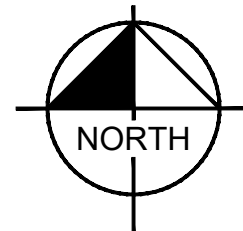

**D49 TRANSPORTATION CENTER**

**SCHOOL DISTRICT NO 49**  
11971 SWINGLINE ROAD  
PEYTON, CO 80831

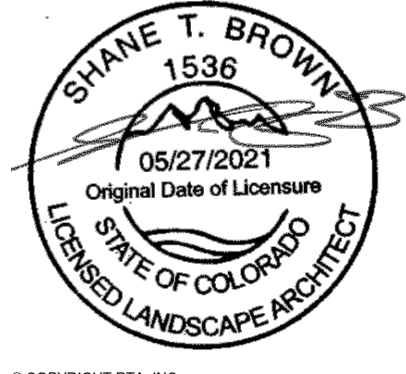

**Landscape Plan**

DATE: 05/23/2022  
PROJECT NUMBER: 2021-041.00

NO.	DATE	DESCRIPTION
1	06/29/2022	ADD IT

ISSUED FOR: CONSTRUCTION DOCUMENTS

MATCHLINE: SEE SHEET L 100

MATCHLINE: SEE SHEET L 102

MATCHLINE: SEE SHEET L 101

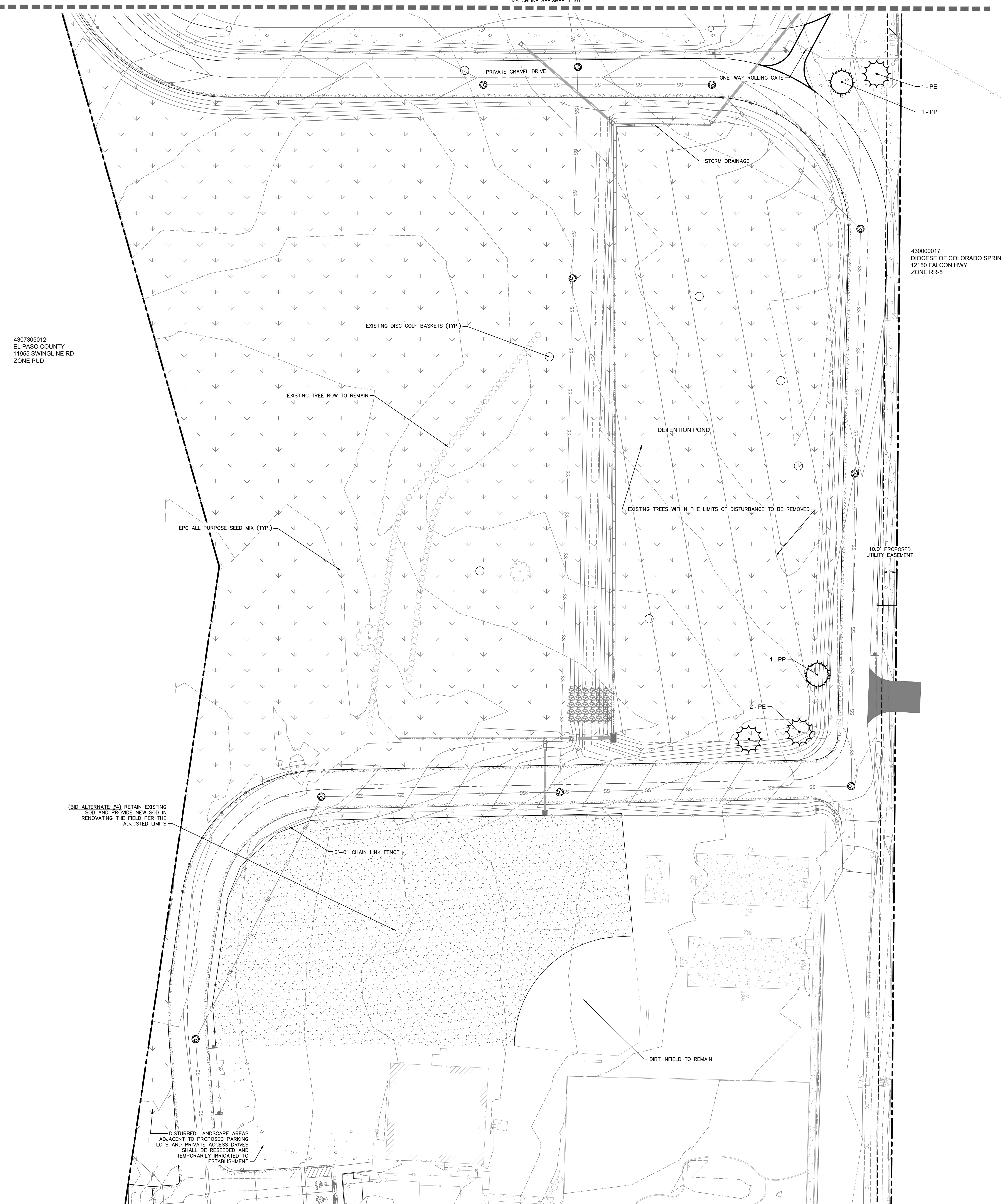

4307305012  
 EL PASO COUNTY  
 11955 SWINGLINE RD  
 ZONE PUD

430000017  
 DIOCESE OF COLORADO SPRINGS  
 12150 FALCON HWY  
 ZONE RR-5

(**BID ALTERNATE #4**) RETAIN EXISTING  
 SOD AND PROVIDE NEW SOD IN  
 RENOVATING THE FIELD PER THE  
 ADJUSTED LIMITS

DISTURBED LANDSCAPE AREAS  
 ADJACENT TO PROPOSED PARKING  
 LOTS AND PRIVATE ACCESS DRIVES  
 SHALL BE RESEEDED AND  
 TEMPORARILY IRRIGATED TO  
 ESTABLISHMENT

### PLANT SCHEDULE

DECIDUOUS TREES	CODE	QTY	BOTANICAL / COMMON NAME
	CO	4	CELTIS OCCIDENTALIS / COMMON HACKBERRY
EVERGREEN TREES	CODE	QTY	BOTANICAL / COMMON NAME
	PE	15	PINUS CEMBRIDGSA / PONDEROSA PINE
	PP	9	PINUS PONDEROSA / PONDEROSA PINE
DECIDUOUS SHRUBS	CODE	QTY	BOTANICAL / COMMON NAME
	BC	13	BERBERIS THUNBERGII / CRIMSON PYGMY / CRIMSON PYGMY JAPANESE BARBERY
	PA	20	PEROVSKIA ABROTANOIDES / RUSSIAN SAGE
	RA	3	RIBES ALPNUM / ALPINE CURRANT
	VA	4	VIBURNUM X RHYTIDOPHYLLOIDES / LANTANAPHYLLUM VIBURNUM
EVERGREEN SHRUBS	CODE	QTY	BOTANICAL / COMMON NAME
	JH	21	JUNIPERUS HORIZONTALIS / CREEPING JUNIPER
	PM	5	PINUS MUGO 'MOPS' / MOPS MUGO PINE
GRASSES	CODE	QTY	BOTANICAL / COMMON NAME
	BB	5	BOUTELOUA GRACILIS 'BLONDE AMBITION' / BLONDE AMBITION BLUE GRAMA
	HS	38	HELICTOTRICHON SEMPERVIRENS / BLUE OAT GRASS
PERENNIALS	CODE	QTY	BOTANICAL / COMMON NAME
	AC	8	AGASTACHE CANA / TEXAS HUMMINGBIRD MINT
	AW	12	ASTER DUMOSUS 'WOODS LIGHT BLUE' / WOODS LIGHT BLUE ASTER
	RM	17	RUDBECKIA PURPUREA / PURPLE CONEFLOWER
GROUND COVERS	CODE	QTY	BOTANICAL / COMMON NAME
	ROCK	8,076 SF	1-1/2" ROCK MULCH SUBMIT SAMPLE FOR REVIEW AND APPROVAL PRIOR TO INSTALLATION.
	ROCK2	2,396 SF	3/8" ROCK MULCH SUBMIT SAMPLE FOR REVIEW AND APPROVAL PRIOR TO INSTALLATION.
	SEED2	150,949 SF	EPC LOW GROW MIX INSTALL PER TABLE S-2. SUBMIT SUPPLIER CUT-SHEET FOR REVIEW AND APPROVAL PRIOR TO INSTALLATION.
	SEED3	270,152 SF	EPC ALL PURPOSE MIX INSTALL PER TABLE S-1. SUBMIT SUPPLIER CUT-SHEET FOR REVIEW AND APPROVAL PRIOR TO INSTALLATION.
	SOD	41,585 SF	POA PRATENSIS / KENTUCKY BLUEGRASS (BID ALTERNATE #4) INSTALL PER DETAIL.
	BOUL	19	DECORATIVE LANDSCAPE BOULDERS. COLOR BY OWNER. UTILIZE ON-SITE MATERIAL IF AVAILABLE.

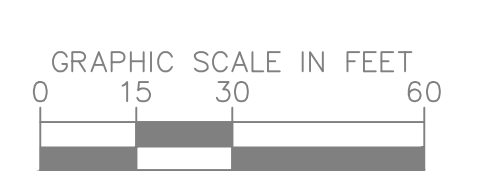
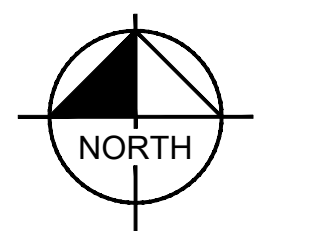

**D49 TRANSPORTATION CENTER**

**SCHOOL DISTRICT NO 49**  
 11971 SWINGLINE ROAD  
 PEYTON, CO 80831

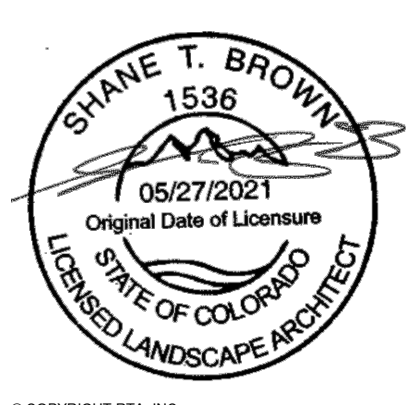

SHEET TITLE  
**Landscape Plan**

DATE PROJECT NUMBER  
**2021-041.00**

DATE  
**05/23/2022**

REVISIONS  
 # DATE DESCRIPTION  
 1 06/20/22 AAK SB

ISSUED FOR  
**CONSTRUCTION DOCUMENTS**

SHEET NO.  
**L-102**

## GENERAL LANDSCAPE SPECIFICATIONS

### A. SCOPE OF WORK

1. THE WORK CONSISTS OF: FURNISHING ALL LABOR, MATERIALS, EQUIPMENT, TOOLS, TRANSPORTATION, AND ANY OTHER APPURTENANCES NECESSARY FOR THE COMPLETION OF THIS PROJECT AS SHOWN ON THE DRAWINGS AND AS SPECIFIED HEREIN.
2. WORK SHALL INCLUDE MAINTENANCE AND WATERING OF ALL CONTRACT PLANTING AREAS UNTIL CERTIFICATION OF ACCEPTANCE BY THE OWNER.

### B. PROTECTION OF EXISTING STRUCTURES

1. ALL EXISTING BUILDINGS, WALKS, WALLS, PAVING, PIPING, OTHER SITE CONSTRUCTION ITEMS, AND PLANTING ALREADY COMPLETED OR ESTABLISHED AND DESIGNATED TO REMAIN SHALL BE PROTECTED FROM DAMAGE BY THE CONTRACTOR UNLESS OTHERWISE SPECIFIED. ALL DAMAGE RESULTING FROM NEGLIGENCE SHALL BE REPAIRED OR REPLACED TO THE SATISFACTION OF THE OWNER, AT NO COST TO THE OWNER.
2. THE CONTRACTOR SHALL BE RESPONSIBLE FOR MAINTAINING ALL NECESSARY BEST MANAGEMENT PRACTICES (BMP) DEVICES ACCORDING TO ALL REGULATORY AGENCY'S STANDARDS THROUGHOUT THE DURATION OF ALL CONSTRUCTION ACTIVITIES.
3. THE CONTRACTOR SHALL BE RESPONSIBLE FOR ANY MAINTENANCE OF TRAFFIC (MOT) THAT MAY BE REQUIRED FOR THE PROJECT.
4. THE CONTRACTOR SHALL BE RESPONSIBLE FOR LOCATING ALL UTILITIES, WHETHER PUBLIC OR PRIVATE, PRIOR TO EXCAVATION. THE OWNER AND DESIGN PROFESSIONAL SHALL NOT BE RESPONSIBLE FOR THE ACCURACY AND COMPLETENESS OF ANY SUCH INFORMATION OR DATA. THE CONTRACTOR SHALL HAVE FULL RESPONSIBILITY FOR REVIEWING AND CHECKING ALL SUCH INFORMATION AND DATA. LOCATING ALL UNDERGROUND FACILITIES DURING CONSTRUCTION, THE SAFETY AND PROTECTION THEREOF; REPAIRING ANY DAMAGE THERE TO RESULTING FROM THE WORK. THE COST OF ALL WILL BE CONSIDERED AS HAVING BEEN INCLUDED IN THE CONTRACT PRICE. THE CONTRACTOR SHALL NOTIFY ANY AFFECTED UTILITY COMPANIES OR AGENCIES IN WRITING AT LEAST 48 HOURS PRIOR TO BEGINNING CONSTRUCTION.

### C. PROTECTION OF EXISTING PLANT MATERIALS

1. THE CONTRACTOR SHALL BE RESPONSIBLE FOR ALL UNAUTHORIZED CUTTING OR DAMAGE TO TREES AND SHRUBS EXISTING OR OTHERWISE CAUSED BY CARELESS EQUIPMENT OPERATION, MATERIAL STOCKPILING, ETC. THIS SHALL INCLUDE COMPACTION BY DRIVING OR PARKING INSIDE THE DRIP-LINE AND SPILLING OIL, GASOLINE, OR OTHER DELETERIOUS MATERIALS WITHIN THE DRIP-LINE. NO MATERIALS SHALL BE BURNED ON SITE. EXISTING TREES KILLED OR DAMAGED SO THAT THEY ARE MISAPPEAR AND/OR UNSUITABLE SHALL BE REPLACED AT THE COST TO THE CONTRACTOR OF FOUR HUNDRED DOLLARS (\$400) PER CALIPER INCH ON AN ESCALATING SCALE WHICH ADDS AN ADDITIONAL TWENTY (20) PERCENT PER INCH OVER FOUR (4) INCHES CALIPER AS FIXED AND AGREED LIQUIDATED DAMAGES. CALIPER SHALL BE MEASURED SIX (6) INCHES ABOVE GROUND LEVEL FOR TREES UP TO AND INCLUDING FOUR (4) INCHES IN CALIPER AND TWELVE (12) INCHES ABOVE GROUND LEVEL FOR TREES OVER FOUR (4) INCHES IN CALIPER.
2. SEE TREE MITIGATION PLAN AND NOTES, IF APPLICABLE.

### D. MATERIALS

#### 1. GENERAL

MATERIAL SAMPLES LISTED BELOW SHALL BE SUBMITTED FOR APPROVAL, ON SITE OR AS DETERMINED BY THE OWNER, UPON APPROVAL, DELIVERY OF MATERIALS MAY COMMENCE.

MATERIAL	SAMPLE SIZE
MULCH	ONE (1) CUBIC FOOT
TOPSOIL MIX	ONE (1) CUBIC FOOT
PLANTS	ONE (1) OF EACH VARIETY (OR TAGGED IN NURSERY)

#### 2. PLANT MATERIALS

1. FURNISH NURSERY-GROWN PLANTS TRUE TO GENUS, SPECIES, VARIETY, CULTIVAR, STEM FORM, SHEARING, AND OTHER FEATURES INDICATED IN PLANT SCHEDULE SHOWN ON DRAWINGS AND COMPLYING WITH ANSI Z60.1 AND THE COLORADO NURSERY ACT, AND WITH HEALTHY ROOT SYSTEMS DEVELOPED BY TRANSPANTING OR ROOT PRUNING. PROVIDE WELL-SHAPED, FULLY BRANCHED, HEALTHY, VIGOROUS STOCK, DENSELY FOLIATED WHEN IN LEAF AND FREE OF DISEASE, PESTS, EGGS, LARVAE, AND DEFECTS SUCH AS KNOTS, SUN SCALD, INJURIES, ABRASIONS, AND DISFIGUREMENT.
2. TREES FOR PLANTING IN ROWS SHALL BE UNIFORM IN SIZE AND SHAPE.
3. NO SUBSTITUTIONS SHALL BE MADE WITHOUT WRITTEN PERMISSION FROM THE PROJECT LANDSCAPE ARCHITECT. ANY ROW TREES MUST BE APPROVED BY OFFICE OF THE CITY FORESTER.
4. PROVIDE PLANTS OF SIZES, GRADES, AND BALL OR CONTAINER SIZES COMPLYING WITH ANSI Z60.1 AND COLORADO NURSERY ACT FOR TYPES AND FORM OF PLANTS REQUIRED. PLANTS OF A LARGER SIZE MAY BE USED IF ACCEPTABLE TO PROJECT LANDSCAPE ARCHITECT WITH A PROPORTIONATE INCREASE IN SIZE OF ROOTS OR BALLS.
5. PLANTS SHALL BE SUBJECT TO INSPECTION AND APPROVAL AT THE PLACE OF GROWTH, OR UPON DELIVERY TO THE SITE, AS DETERMINED BY THE OWNER, FOR QUALITY, SIZE, AND VARIETY. SUCH APPROVAL SHALL NOT IMPAIR THE RIGHT OF INSPECTION AND REJECTION AT THE SITE DURING PROGRESS OF THE WORK OR AFTER COMPLETION FOR SIZE AND CONDITION OF ROOT BALLS OR ROOTS, LATENT DEFECTS OR INJURIES. REJECTED PLANTS SHALL BE REMOVED IMMEDIATELY FROM THE SITE. NOTICE REQUIRING INSPECTION SHALL BE SUBMITTED IN WRITING BY THE CONTRACTOR AT LEAST ONE (1) WEEK PRIOR TO ANTICIPATED DATE.
6. TREES WITH DAMAGED, CROOKED, OR MULTIPLE LEADERS; TIGHT VERTICAL BRANCHES WHERE BARK IS SQUEEZED BETWEEN TWO BRANCHES OR BETWEEN BRANCH AND TRUNK (INCLUDED BARK); CROSSING TRUNKS; CUT-OFF LIMBS MORE THAN 1/2 INCH (19 MM) IN DIAMETER, OR WITH STEM GIRDLING ROOTS WILL BE REJECTED.
7. FURNISH TREES AND SHRUBS WITH ROOT BALLS MEASURED FROM TOP OF ROOT BALL, WHICH SHALL BEGIN AT ROOT FLARE ACCORDING TO ANSI Z60.1 AND COLORADO NURSERY ACT. ROOT FLARE SHALL BE VISIBLE BEFORE PLANTING.
8. LABEL AT LEAST ONE PLANT OF EACH VARIETY, SIZE, AND CALIPER WITH A SECURELY ATTACHED, WATERPROOF TAG BEARING LEGIBLE DESIGNATION OF COMMON NAME AND FULL SCIENTIFIC NAME, INCLUDING GENUS AND SPECIES. INCLUDE NOMENCLATURE FOR HYBRID, VARIETY, OR CULTIVAR, IF APPLICABLE FOR THE PLANT AS SHOWN ON DRAWINGS.
9. IF FORMAL ARRANGEMENTS OR CONSECUTIVE ORDER OF PLANTS IS SHOWN ON DRAWINGS, SELECT STOCK FOR UNIFORM HEIGHT AND SPREAD, AND NUMBER THE LABELS TO ASSURE SYMMETRY IN PLANTING.

### E. SOIL MIXTURE

1. CONTRACTOR SHALL TEST EXISTING SOIL AND AMEND AS NECESSARY IN ACCORDANCE WITH THE GUIDELINES BELOW.
2. SOIL MIXTURE SHALL CONSIST OF TWO PARTS OF TOPSOIL AND ONE PART SAND, AS DESCRIBED BELOW. CONTRACTOR TO SUBMIT SAMPLES AND PH TESTING RESULTS OF SOIL MIXTURE FOR OWNER'S REPRESENTATIVE APPROVAL PRIOR TO PLANT INSTALLATION OPERATIONS COMMENCE.
3. TOPSOIL FOR USE IN PREPARING SOIL MIXTURE FOR BACKFILLING PLANT OPENINGS SHALL BE FERTILE, FRABLE, AND OF A LOAMY CHARACTER, REASONABLY FREE OF SUBSOIL, CLAY LUMPS, BRUSH WEEDS AND OTHER LITTER, FREE OF ROOTS, STUMPS, STONES LARGER THAN 2" IN ANY DIRECTION, AND OTHER EXTRANEOUS OR TOXIC MATTER HARMFUL TO PLANT GROWTH. IT SHALL CONTAIN THREE (3) TO FIVE (5) PERCENT DECOMPOSED ORGANIC MATTER, HAVE A PH BETWEEN 5.5 AND 8.0, AND SOLUBLE SALTS LESS THAN 3.0 MH/SOIL. SUBMIT SOIL SAMPLE AND PH TESTING RESULTS FOR APPROVAL.
4. SAND SHALL BE COARSE, CLEAN, WELL-DRAINING, NATIVE SAND.
5. TREES SHALL BE PLANTED IN THE EXISTING NATIVE SOIL ON SITE, UNLESS DETERMINED TO BE UNSUITABLE - AT WHICH POINT THE CONTRACTOR SHALL CONTACT THE PROJECT LANDSCAPE ARCHITECT TO DISCUSS ALTERNATE RECOMMENDATION PRIOR TO PLANTING.

### F. WATER

1. WATER NECESSARY FOR PLANTING AND MAINTENANCE SHALL BE OF SATISFACTORY QUALITY TO SUSTAIN ADEQUATE PLANT GROWTH AND SHALL NOT CONTAIN HARMFUL, NATURAL OR MAN-MADE ELEMENTS DETRIMENTAL TO PLANTS. WATER MEETING THE ABOVE STANDARD SHALL BE OBTAINED ON THE SITE FROM THE OWNER, IF AVAILABLE, AND THE CONTRACTOR SHALL BE RESPONSIBLE TO MAKE ARRANGEMENTS FOR ITS USE BY HIS TANKS, HOSES, SPRINKLERS, ETC. IF SUCH WATER IS NOT AVAILABLE AT THE SITE, THE CONTRACTOR SHALL PROVIDE SATISFACTORY WATER FROM SOURCES OFF THE SITE AT NO ADDITIONAL COST TO THE OWNER.

\*WATERING/IRRIGATION RESTRICTIONS MAY APPLY - REFER TO PROPERTY'S JURISDICTIONAL AUTHORITY.

### G. FERTILIZER

1. CONTRACTOR SHALL PROVIDE FERTILIZER APPLICATION SCHEDULE TO OWNER, AS APPLICABLE TO SOIL TYPE, PLANT INSTALLATION TYPE, AND SITE'S PROPOSED USE. SUGGESTED FERTILIZER TYPES SHALL BE ORGANIC OR OTHERWISE NATURALLY-DERIVED.
- \*FERTILIZER RESTRICTIONS MAY APPLY - REFER TO PROPERTY'S JURISDICTIONAL AUTHORITY.

### H. MULCH

1. MULCH MATERIAL SHALL BE MOISTENED AT THE TIME OF APPLICATION TO PREVENT WIND DISPLACEMENT, AND APPLIED AT A DEPTH OF THREE (3) INCHES CLEAR MULCH FROM EACH PLANT'S CROWN (BASE) OR AS SHOWN IN PLANTING DETAILS. MULCH SHALL BE DOUBLE SHREDED HARDWOOD MULCH. DYED MULCH IS NOT ACCEPTABLE. SUBMIT SAMPLES TO PROJECT LANDSCAPE ARCHITECT FOR APPROVAL. MULCH SHALL BE PROVIDED OVER THE ENTIRE AREA OF EACH SHRUB BED, GROUND COVER, VINE BED, AND TREE RING (6" MINIMUM) PLANTED UNDER THIS CONTRACT, AS WELL AS FOR ANY EXISTING LANDSCAPE AREAS AS SHOWN ON PLANS.

### I. DIGGING AND HANDLING

1. ALL TREES SPECIFIED SHALL BE BALLED AND BURLAPPED (B&B) UNLESS OTHERWISE APPROVED BY PROJECT LANDSCAPE ARCHITECT.
2. PROTECT ROOTS OR ROOT BALLS OF PLANTS AT ALL TIMES FROM SUN, DRYING WINDS, WATER AND FREEZING, AS NECESSARY UNTIL PLANTING. PLANT MATERIALS SHALL BE ADEQUATELY PACKED TO PREVENT DAMAGE DURING TRANSIT. TREES TRANSPORTED MORE THAN TEN (10) MILES OR WHICH ARE NOT PLANTED WITHIN THREE (3) DAYS OF DELIVERY TO THE SITE SHALL BE SPRAYED WITH AN ANTI-TRANSPIRANT PRODUCT ("WILT-PRUF" OR EQUAL) TO MINIMIZE TRANSPIRATIONAL WATER LOSS.
3. B&B AND FIELD GROWN (FG) PLANTS SHALL BE DUG WITH FIRM, NATURAL BALLS OF SOIL OF SUFFICIENT SIZE TO ENCOMPASS THE FIBROUS AND FEEDING ROOTS OF THE PLANTS. NO PLANTS MOVED WITH A ROOT BALL SHALL BE PLANTED IF THE BALL IS CRACKED OR BROKEN. PLANTS SHALL NOT BE HANDLED BY STEMS.

### J. CONTAINER GROWN STOCK

1. ALL CONTAINER GROWN MATERIAL SHALL BE HEALTHY, VIGOROUS, WELL-ROOTED PLANTS ESTABLISHED IN THE CONTAINER IN WHICH THEY ARE SOLD. THE PLANTS SHALL HAVE TOPS WHICH ARE OF GOOD QUALITY AND ARE IN A HEALTHY GROWING CONDITION.
2. AN ESTABLISHED CONTAINER GROWN PLANT SHALL BE TRANSPLANTED INTO A CONTAINER AND GROWN IN THAT CONTAINER SUFFICIENTLY LONG ENOUGH FOR THE NEW FIBROUS ROOTS TO HAVE DEVELOPED SO THAT THE ROOT MASS WILL RETAIN ITS SHAPE AND HOLD TOGETHER WHEN REMOVED FROM THE CONTAINER. CONTAINER GROWN STOCK SHALL NOT BE HANDLED BY THEIR STEMS.
3. ROOT BOUND PLANTS ARE NOT ACCEPTABLE AND WILL BE REJECTED.

### K. MATERIALS LIST

1. QUANTITIES NECESSARY TO COMPLETE THE WORK ON THE DRAWINGS SHALL BE FURNISHED BY THE CONTRACTOR. QUANTITY ESTIMATES HAVE BEEN MADE CAREFULLY, BUT THE LANDSCAPE ARCHITECT OR OWNER ASSUMES NO LIABILITY FOR OMISSIONS OR ERRORS. SHOULD A DISCREPANCY OCCUR BETWEEN THE PLANS AND THE PLANT LIST QUANTITY, THE PLANS SHALL GOVERN. ALL DIMENSIONS AND/OR SIZES SPECIFIED SHALL BE THE MINIMUM ACCEPTABLE SIZE.

### L. FINE GRADING

1. FINE GRADING UNDER THIS CONTRACT SHALL CONSIST OF FINAL FINISHED GRADING OF LAWN AND PLANTING AREAS THAT HAVE BEEN DISTURBED DURING CONSTRUCTION.
2. THE CONTRACTOR SHALL FINE GRADE THE LAWN AND PLANTING AREAS TO BRING THE ROUGH GRADE UP TO FINAL FINISHED GRADE ALLOWING FOR THICKNESS OF SOIL AND/OR MULCH DEPTH.
3. ALL PLANTING AREAS SHALL BE GRADED AND MAINTAINED FOR POSITIVE DRAINAGE TO SURFACE/SUBSURFACE STORM DRAIN SYSTEMS. AREAS ADJACENT TO BUILDINGS SHALL SLOPE AWAY FROM THE BUILDINGS. REFER TO CIVIL ENGINEER'S PLANS FOR FINAL GRADES, IF APPLICABLE.

### M. PLANTING PROCEDURES

1. THE CONTRACTOR SHALL CLEAN WORK AND SURROUNDING AREAS OF ALL RUBBISH OR OBJECTIONABLE MATTER DAILY. ALL MORTAR, CEMENT, BUILDING MATERIALS, AND TOXIC MATERIAL SHALL BE COMPLETELY REMOVED FROM PLANTING AREAS. THESE MATERIALS SHALL NOT BE MIXED WITH THE SOIL. SHOULD THE CONTRACTOR FIND SUCH SOIL CONDITIONS IN PLANTING AREAS WHICH WILL ADVERSELY AFFECT THE PLANT GROWTH, THE CONTRACTOR SHALL IMMEDIATELY CALL IT TO THE ATTENTION OF THE OWNER'S REPRESENTATIVE. FAILURE TO DO SO BEFORE PLANTING SHALL MAKE THE CORRECTIVE MEASURES THE RESPONSIBILITY OF THE CONTRACTOR.
2. VERIFY LOCATIONS OF ALL UTILITIES, CONDUITS, SUPPLY LINES AND CABLES, INCLUDING BUT NOT LIMITED TO: ELECTRIC, GAS (LINES AND TANKS), WATER, SANITARY SEWER, STORMWATER SYSTEMS, CABLE, AND TELEPHONE. PROPERLY MAINTAIN AND PROTECT EXISTING UTILITIES. CALL COLORADO (811) TO LOCATE UTILITIES AT LEAST 48 HOURS PRIOR TO CONSTRUCTION.
3. CONTRACTOR IS RESPONSIBLE TO REMOVE ALL EXISTING AND IMPORTED LIMESTONE AND LIMESTONE SUB-BASE FROM ALL PLANTING AREAS TO A MINIMUM DEPTH OF 3" OR TO NATIVE SOIL. CONTRACTOR IS RESPONSIBLE TO BACKFILL THESE PLANTING AREAS TO ROUGH FINISHED GRADE WITH CLEAN TOPSOIL FROM AN ON-SITE SOURCE OR AN IMPORTED SOURCE. IF LIMESTONE OR OTHER ADVERSE CONDITIONS OCCUR IN PLANTED AREAS AFTER 36" DEEP EXCAVATION BY THE CONTRACTOR, AND POSITIVE DRAINAGE CAN NOT BE ACHIEVED, CONTRACTOR SHALL UTILIZE POOR DRAINAGE CONDITION PLANTING DETAIL.
4. FURNISH NURSERY'S CERTIFICATE OF COMPLIANCE WITH ALL REQUIREMENTS AS SPECIFIED HEREIN. INSPECT AND SELECT PLANT MATERIALS BEFORE PLANTS ARE DUG AT NURSERY OR GROWING SITE.
5. COMPLY WITH APPLICABLE FEDERAL, STATE, COUNTY, AND LOCAL REGULATIONS GOVERNING LANDSCAPE AND MATERIALS AND WORK. UPON ARRIVAL AT THE SITE, PLANTS SHALL BE THOROUGHLY WATERED AND PROPERLY MAINTAINED UNTIL PLANTED. PLANTS STORED ON-SITE SHALL NOT REMAIN UNPLANTED OR APPROPRIATELY HEADED IN FOR A PERIOD EXCEEDING TWENTY-FOUR (24) HOURS. AT ALL TIMES WORKMANLIKE METHODS CUSTOMARY TO ACCEPTED HORTICULTURAL PRACTICES AS USED IN THE TRADE SHALL BE EXERCISED.
6. WORK SHALL BE COORDINATED WITH OTHER TRADES TO PREVENT CONFLICTS. COORDINATE PLANTING WITH IRRIGATION WORK TO ASSURE AVAILABILITY OF WATER AND PROPER LOCATION OF IRRIGATION APPURTENANCES AND PLANTS.
7. ALL PLANTING OPENINGS SHALL BE EXCAVATED TO SIZE AND DEPTH IN ACCORDANCE WITH ANSI Z60.1-2014 AMERICAN STANDARD FOR NURSERY STOCK.
8. TEST ALL TREE OPENINGS WITH WATER BEFORE PLANTING TO ASSURE PROPER DRAINAGE PERCOLATION IS AVAILABLE. NO ALLOWANCE WILL BE MADE FOR LOST PLANTS DUE TO IMPROPER DRAINAGE. IF POOR DRAINAGE EXISTS, UTILIZE "POOR DRAINAGE CONDITION" PLANTING DETAIL.
9. TREES SHALL BE SET PLUMB AND HELD IN POSITION UNTIL THE PLANTING MIXTURE HAS BEEN FLUSHED INTO PLACE WITH A SLOW, FULL HOSE STREAM. ALL PLANTING SHALL BE PERFORMED BY PERSONNEL FAMILIAR WITH PLANTING PROCEDURES AND UNDER THE SUPERVISION OF A QUALIFIED LANDSCAPE FOREMAN.
10. PRIOR TO EXCAVATION OF TREE OPENINGS, AN AREA EQUAL TO TWO TIMES THE DIAMETER OF THE ROOT BALL SHALL BE ROTO-TILLED TO A DEPTH EQUAL TO THE DEPTH OF THE ROOT BALL.
11. EXCAVATION OF TREE OPENINGS SHALL BE PERFORMED USING EXTREME CARE TO AVOID DAMAGE TO SURFACE AND SUBSURFACE ELEMENTS SUCH AS UTILITIES OR HARDSCAPE ELEMENTS, FOOTERS AND PREPARED SUB-BASES.
12. IN CONTINUOUS SHRUB AND GROUND COVER BEDS, THE ROTO-TILLED PERIMETER SHOULD EXTEND TO A DISTANCE OF ONE FOOT BEYOND THE DIAMETER OF A SINGLE ROOT BALL. THE BED SHALL BE TILLED TO A DEPTH EQUAL TO THE ROOT BALL DEPTH PLUS 6".
13. TREE OPENINGS FOR WELL DRAINED SOILS SHALL BE DUG SO THAT THE BOTTOM OF THE ROOT BALL WILL REST ON UNDISTURBED SOIL AND THE TOP OF THE ROOT BALL WILL BE FLUSH WITH FINISH GRADE. IN POORLY DRAINED SOILS THE TREE OPENING SHALL BE DUG SO THAT THE ROOT BALL RESTS ON UNDISTURBED SOIL AND THE TOP OF THE ROOT BALL IS 1" ABOVE FINISH GRADE. PLANT PIT WALLS SHALL BE SCORED PRIOR TO PLANT INSTALLATION.
14. TAKE ALL NECESSARY PRECAUTIONS TO AVOID DAMAGE TO BUILDINGS AND BUILDING STRUCTURES WHILE INSTALLING TREES.
15. SOIL MIXTURE SHALL BE AS SPECIFIED IN SECTION "E".
16. TREES AND SHRUBS SHALL BE SET STRAIGHT AT AN ELEVATION THAT, AFTER SETTLEMENT, THE PLANT CROWN WILL STAND ONE (1) TO TWO (2) INCHES ABOVE GRADE. EACH PLANT SHALL BE SET IN THE CENTER OF THE PIT. SOIL MIXTURE SHALL BE BACK FILLED, THOROUGHLY TAMPED AROUND THE BALL, AND SETTLED BY WATER (AFTER TAMPING).
17. AMEND PINE AND OAK PLANT OPENINGS WITH ECTOMYCORRHIZAL SOIL APPLICATION PER MANUFACTURER'S RECOMMENDATION. ALL OTHER PLANT OPENINGS SHALL BE AMENDED WITH ENDOMYCORRHIZAL SOIL APPLICATION PER MANUFACTURER'S RECOMMENDATION. PROVIDE PRODUCT INFORMATION SUBMITTAL PRIOR TO INSTALLATION.
18. FILL HOLE WITH SOIL MIXTURE, MAKING CERTAIN ALL SOIL IS SATURATED. TO DO THIS, FILL HOLE WITH WATER AND ALLOW TO SOAK MINIMUM TWENTY (20) MINUTES, STIRRING IF NECESSARY TO GET SOIL THOROUGHLY WET. PACK LIGHTLY WITH FEET, ADD MORE WET SOIL MIXTURE. DO NOT COVER TOP OF BALL WITH SOIL MIXTURE.
19. ALL BURLAP, ROPE, WIRES, BASKETS, ETC., SHALL BE REMOVED FROM THE SIDES AND TOPS OF BALLS, BUT NO BURLAP SHALL BE PULLED FROM UNDERNEATH.
20. TREES SHALL BE PRUNED, IN ACCORDANCE WITH ANSI A-300, TO PRESERVE THE NATURAL CHARACTER OF THE PLANT. ALL SOFT WOOD OR SUCKER GROWTH AND ALL BROKEN OR BADLY DAMAGED BRANCHES SHALL BE REMOVED WITH A CLEAN CUT. ALL PRUNING TO BE PERFORMED BY CERTIFIED ARBORIST.
21. SHRUBS AND GROUND COVER PLANTS SHALL BE EVENLY SPACED IN ACCORDANCE WITH THE DRAWINGS AND AS INDICATED ON THE PLANT LIST. MATERIALS INSTALLED SHALL MEET MINIMUM SPECIFICATION REQUIREMENTS OR QUANTITIES SHOWN ON PLANS, WHICHEVER IS GREATER. CULTIVATE ALL PLANTING AREAS TO A MINIMUM DEPTH OF 6". REMOVE AND DISPOSE ALL DEBRIS. MIX TOP 4" OF THE PLANTING SOIL MIXTURE AS SPECIFIED IN SECTION "E", THOROUGHLY WATER ALL PLANTS AFTER INSTALLATION.
22. TREE GUYING AND BRACING SHALL BE INSTALLED BY THE CONTRACTOR IN ACCORDANCE WITH THE PLANS TO INSURE STABILITY AND MAINTAIN TREES IN AN UPRIGHT POSITION. IF THE CONTRACTOR AND OWNER DECIDE TO WAIVE THE TREE GUYING AND BRACING, THE OWNER SHALL NOTIFY THE PROJECT LANDSCAPE ARCHITECT IN WRITING AND AGREE TO INDEMNIFY AND HOLD HARMLESS THE PROJECT LANDSCAPE ARCHITECT IN THE EVENT UNSUPPORTED TREES PLANTED UNDER THIS CONTRACT FALL AND DAMAGE PERSON OR PROPERTY.
23. ALL PLANT BEDS SHALL BE KEPT FREE OF NOXIOUS WEEDS UNTIL FINAL ACCEPTANCE OF WORK. IF DIRECTED BY THE OWNER, "ROUND-UP" SHALL BE APPLIED FOR WEED CONTROL BY QUALIFIED PERSONNEL TO ALL PLANTING AREAS IN SPOT APPLICATIONS PER MANUFACTURER'S RECOMMENDATIONS. PRIOR TO FINAL INSPECTION, TREAT ALL PLANTING BEDS WITH AN APPROVED PRE-EMERGENT HERBICIDE AT AN APPLICATION RATE RECOMMENDED BY THE MANUFACTURER, (AS ALLOWED BY JURISDICTIONAL AUTHORITY).

### N. LAWN SODDING

1. THE WORK CONSISTS OF LAWN BED PREPARATION, SOIL PREPARATION, AND SODDING COMPLETE, IN STRICT ACCORDANCE WITH THE SPECIFICATIONS AND THE APPLICABLE DRAWINGS TO PRODUCE A "TURF" GRASS LAWN ACCEPTABLE TO THE OWNER.
2. ALL AREAS THAT ARE TO BE SODDED SHALL BE CLEARED OF ANY ROUGH GRASS, WEEDS, AND DEBRIS BY MEANS OF A SOD CUTTER TO A DEPTH OF THREE (3) INCHES, AND THE GROUND BROUGHT TO AN EVEN GRADE. THE ENTIRE SURFACE SHALL BE ROLLED WITH A ROLLER WEIGHING NOT MORE THAN ONE-HUNDRED (100) POUNDS PER FOOT OF WIDTH. DURING THE ROLLING, ALL DEPRESSIONS CAUSED BY SETTLEMENT SHALL BE FILLED WITH ADDITIONAL SOIL, AND THE SURFACE SHALL BE REGRADED AND ROLLED UNTIL PRESENTING A SMOOTH AND EVEN FINISH TO THE REQUIRED GRADE.
3. PREPARE LOOSE BED FOUR (4) INCHES DEEP. HAND RAKE UNTIL ALL BUMPS AND DEPRESSIONS ARE REMOVED. WET PREPARED AREA THOROUGHLY.
4. SODDING
  - a. THE CONTRACTOR SHALL SOD ALL AREAS THAT ARE NOT PAVED OR PLANTED AS DESIGNATED ON THE DRAWINGS WITHIN THE CONTRACT LIMITS, UNLESS SPECIFICALLY NOTED OTHERWISE.
  - b. SOD PANELS SHALL BE LAID TIGHTLY TOGETHER SO AS TO MAKE A SOLID SODDED LAWN AREA. SOD SHALL BE LAID UNIFORMLY AGAINST THE EDGES OF ALL CURBS AND OTHER HARDSCAPE ELEMENTS, PAVED AND PLANTED AREAS, ADJACENT TO BUILDINGS. A 24 INCH STONE MULCH STRIP SHALL BE PROVIDED, IMMEDIATELY FOLLOWING SOD LAYING. THE LAWN AREAS SHALL BE ROLLED WITH A LAWN ROLLER CUSTOMARILY USED FOR SUCH PURPOSES, AND THEN THOROUGHLY IRRIGATED. IF, IN THE OPINION OF THE OWNER, TOP-DRESSING IS NECESSARY AFTER ROLLING TO FILL THE VOIDS BETWEEN THE SOD PANELS AND TO EVEN OUT INCONSISTENCIES IN THE SOD, CLEAN SAND, AS APPROVED BY THE OWNER'S REPRESENTATIVE, SHALL BE UNIFORMLY SPREAD OVER THE ENTIRE SURFACE OF THE SOD AND THOROUGHLY WATERED IN. FERTILIZE INSTALLED SOD AS ALLOWED BY PROPERTY'S JURISDICTIONAL AUTHORITY.
5. DURING DELIVERY, PRIOR TO, AND DURING THE PLANTING OF THE LAWN AREAS, THE SOD PANELS SHALL AT ALL TIMES BE PROTECTED FROM EXCESSIVE DRYING AND UNNECESSARY EXPOSURE OF THE ROOTS TO THE SUN. ALL SOD SHALL BE STACKED SO AS NOT TO BE DAMAGED BY SWEATING OR EXCESSIVE HEAT AND MOISTURE.
6. LAWN MAINTENANCE
  - a. WITHIN THE CONTRACT LIMITS, THE CONTRACTOR SHALL PRODUCE A DENSE, WELL ESTABLISHED LAWN. THE CONTRACTOR SHALL BE RESPONSIBLE FOR THE REPAIR AND RE-SODDING OF ALL ERODED, SUNKEN OR BARE SPOTS (LARGER THAN 12"x12") UNTIL CERTIFICATION OF ACCEPTANCE BY THE OWNER'S REPRESENTATIVE. REPAIRED SODDING SHALL BE ACCOMPLISHED AS IN THE ORIGINAL WORK, INCLUDING REGRADING IF NECESSARY.
  - b. CONTRACTOR SHALL BE RESPONSIBLE FOR ESTABLISHING AND MAINTAINING SOD LAWN UNTIL ACCEPTANCE BY THE OWNER'S REPRESENTATIVE. PRIOR TO AND UPON ACCEPTANCE, CONTRACTOR TO PROVIDE WATERING/IRRIGATION SCHEDULE TO OWNER. OBSERVE ALL APPLICABLE WATERING RESTRICTIONS AS SET FORTH BY THE PROPERTY'S JURISDICTIONAL AUTHORITY.

### O. EDGING

- a. CONTRACTOR SHALL INSTALL 4"x4" ROLLED TOP STEEL EDGING BETWEEN ALL SODDISED AREAS AND PLANTING BEDS.

### P. CLEANUP

1. UPON COMPLETION OF ALL PLANTING WORK AND BEFORE FINAL ACCEPTANCE, THE CONTRACTOR SHALL REMOVE ALL MATERIAL, EQUIPMENT, AND DEBRIS RESULTING FROM CONTRACTORS WORK. ALL PAVED AREAS SHALL BE CLEANED AND THE SITE LEFT IN A NEAT AND ACCEPTABLE CONDITION AS APPROVED BY THE OWNER'S REPRESENTATIVE.

### Q. PLANT MATERIAL MAINTENANCE

1. ALL PLANTS AND PLANTING INCLUDED UNDER THIS CONTRACT SHALL BE MAINTAINED BY WATERING, CULTIVATING, SPRAYING, PRUNING, AND ALL OTHER OPERATIONS (SUCH AS RE-STAKING OR REPAIRING GUY SUPPORTS) NECESSARY TO INSURE A HEALTHY PLANT CONDITION BY THE CONTRACTOR UNTIL CERTIFICATION OF ACCEPTANCE BY THE OWNER'S REPRESENTATIVE.

### R. FINAL INSPECTION AND ACCEPTANCE OF WORK

1. FINAL INSPECTION AT THE END OF THE WARRANTY PERIOD SHALL BE ON PLANTING, CONSTRUCTION AND ALL OTHER INCIDENTAL WORK PERTAINING TO THIS CONTRACT. ANY REPLACEMENT AT THIS TIME SHALL BE SUBJECT TO THE SAME ONE (1) YEAR WARRANTY (OR AS SPECIFIED BY THE LANDSCAPE ARCHITECT OR OWNER IN WRITING) BEGINNING WITH THE TIME OF REPLACEMENT AND ENDING WITH THE SAME INSPECTION AND ACCEPTANCE HEREIN DESCRIBED.

### S. WARRANTY

1. THE LIFE AND SATISFACTORY CONDITION OF ALL PLANT MATERIAL INSTALLED (INCLUDING SOD) BY THE LANDSCAPE CONTRACTOR SHALL BE WARRANTED BY THE CONTRACTOR FOR A MINIMUM OF ONE (1) CALENDAR YEAR COMMENCING AT THE TIME OF CERTIFICATION OF ACCEPTANCE BY THE OWNER'S REPRESENTATIVE.
2. ANY PLANT NOT FOUND IN A HEALTHY GROWING CONDITION AT THE END OF THE WARRANTY PERIOD SHALL BE REMOVED FROM THE SITE AND REPLACED AS SOON AS WEATHER CONDITIONS PERMIT. ALL REPLACEMENTS SHALL BE PLANTS OF THE SAME KIND AND SIZE AS SPECIFIED IN THE PLANT LIST. THEY SHALL BE FURNISHED PLANTED AND MULCHED AS SPECIFIED AT NO ADDITIONAL COST TO THE OWNER.
3. IN THE EVENT THE OWNER DOES NOT CONTRACT WITH THE CONTRACTOR FOR LANDSCAPE AND IRRIGATION MAINTENANCE, THE CONTRACTOR SHOULD VISIT THE PROJECT SITE PERIODICALLY DURING THE ONE (1) YEAR WARRANTY PERIOD TO EVALUATE MAINTENANCE PROCEDURES BEING PERFORMED BY THE OWNER. CONTRACTOR SHALL NOTIFY THE OWNER IN WRITING OF MAINTENANCE PROCEDURES OR CONDITIONS WHICH THREATEN VIGOROUS AND HEALTHY PLANT GROWTH.

### NOTES:

1. LANDSCAPE IMPROVEMENTS AND MAINTENANCE SHALL BE THE RESPONSIBILITY OF OWNER, AND/ OR THEIR ASSIGNS.
2. ALL STREET TREES AND STREETSCAPE IMPROVEMENTS LOCATED IN THE ROW WILL BE MAINTAINED BY THE ABUTTING PROPERTY OWNER.

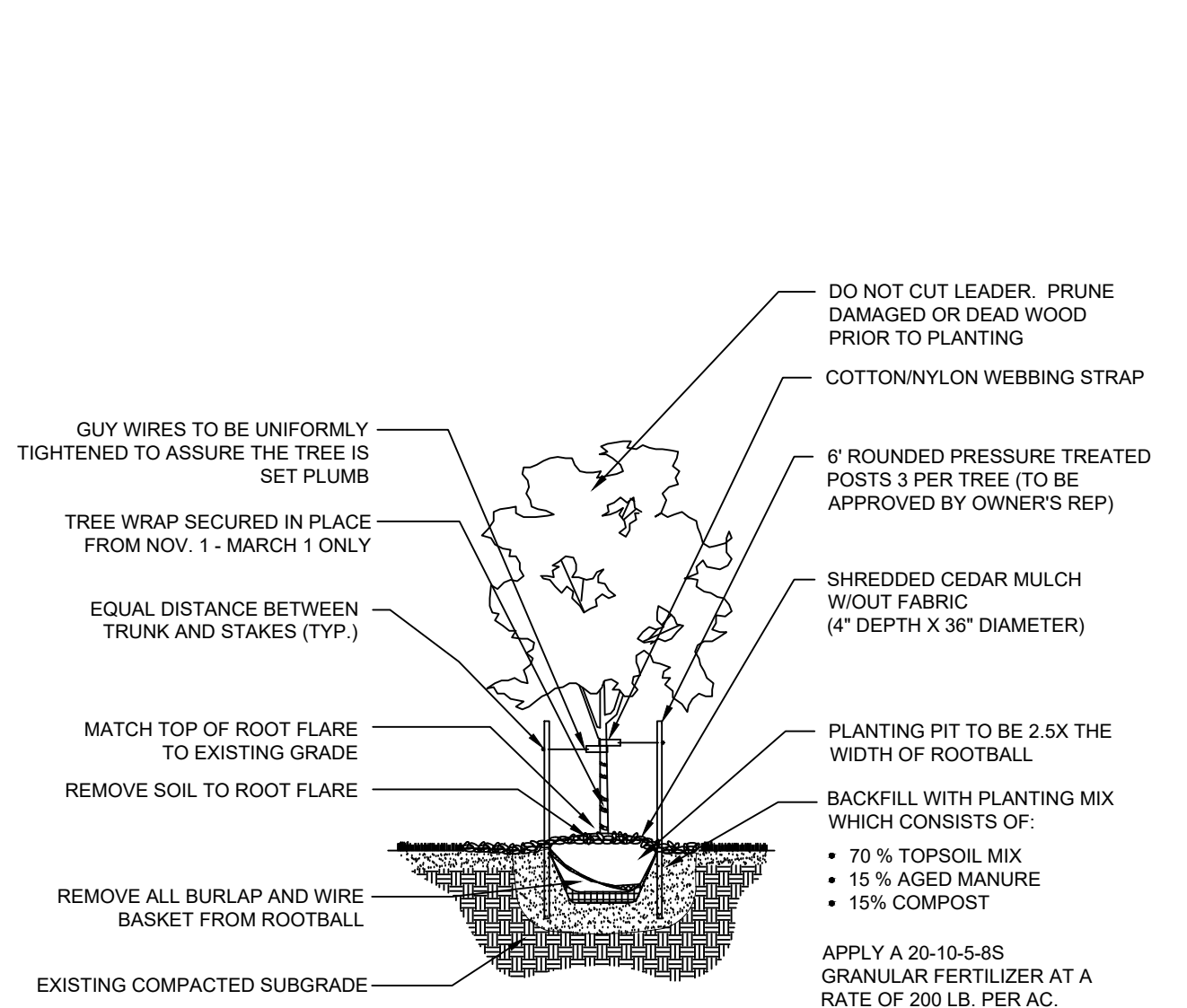

**1 DECIDUOUS TREE PLANTING**  
NTS 096-636-005-02

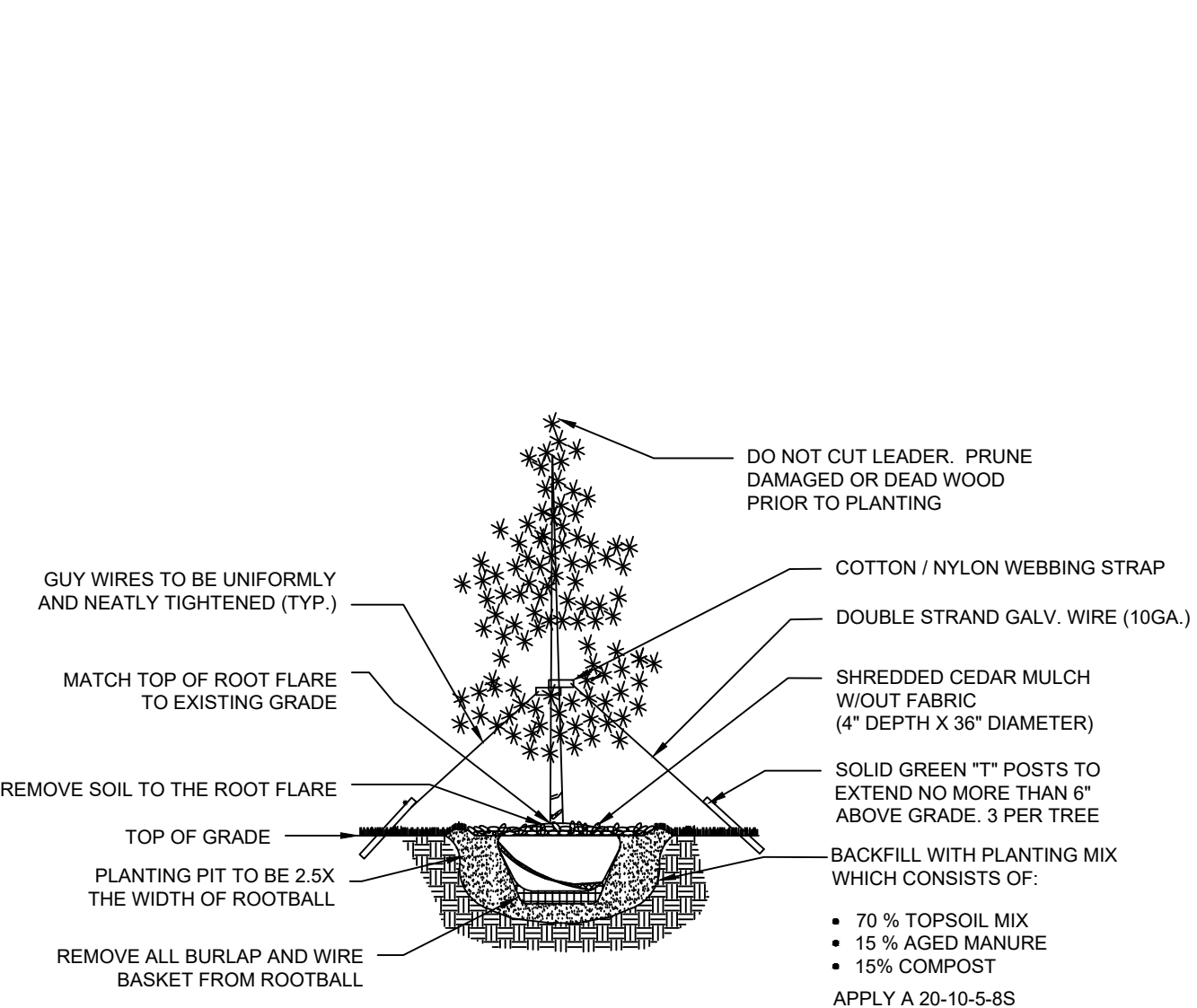

**2 EVERGREEN TREE PLANTING**  
NTS 096-636-005-03

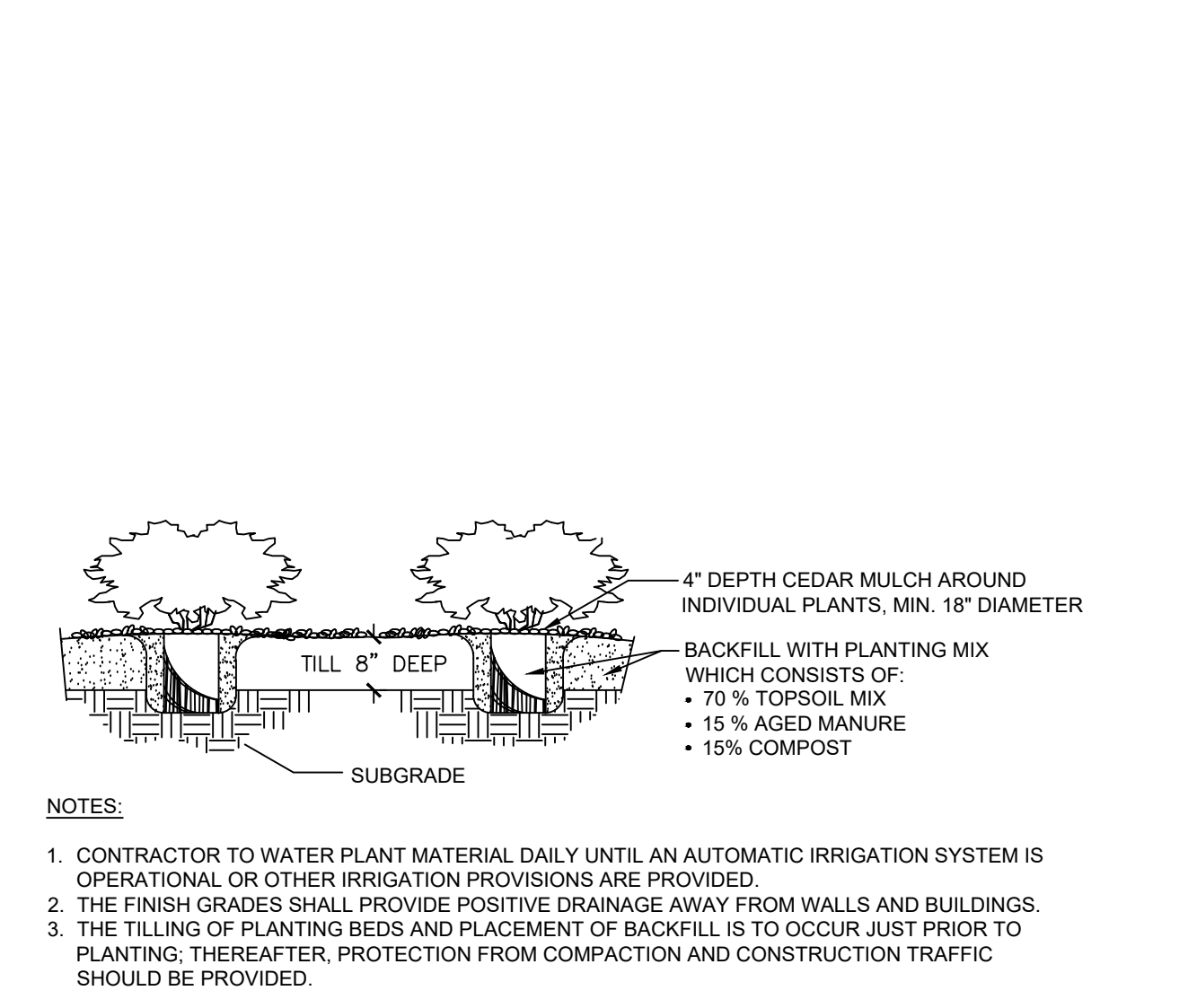

**3 SHRUB PLANTING**  
NTS 096-636-005-05

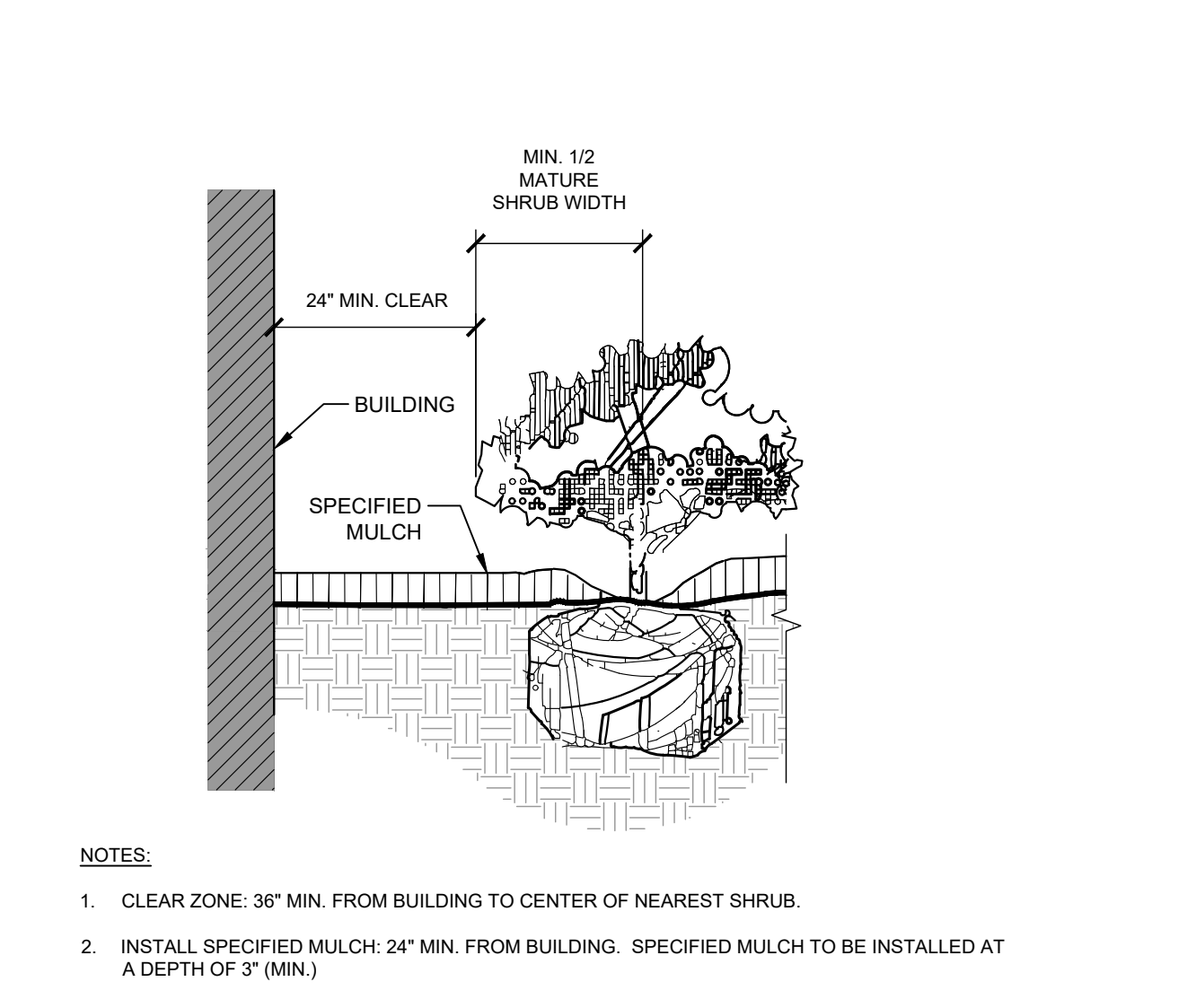

**4 PLANTINGS ADJACENT TO BUILDINGS**  
NTS 096-636-005-07

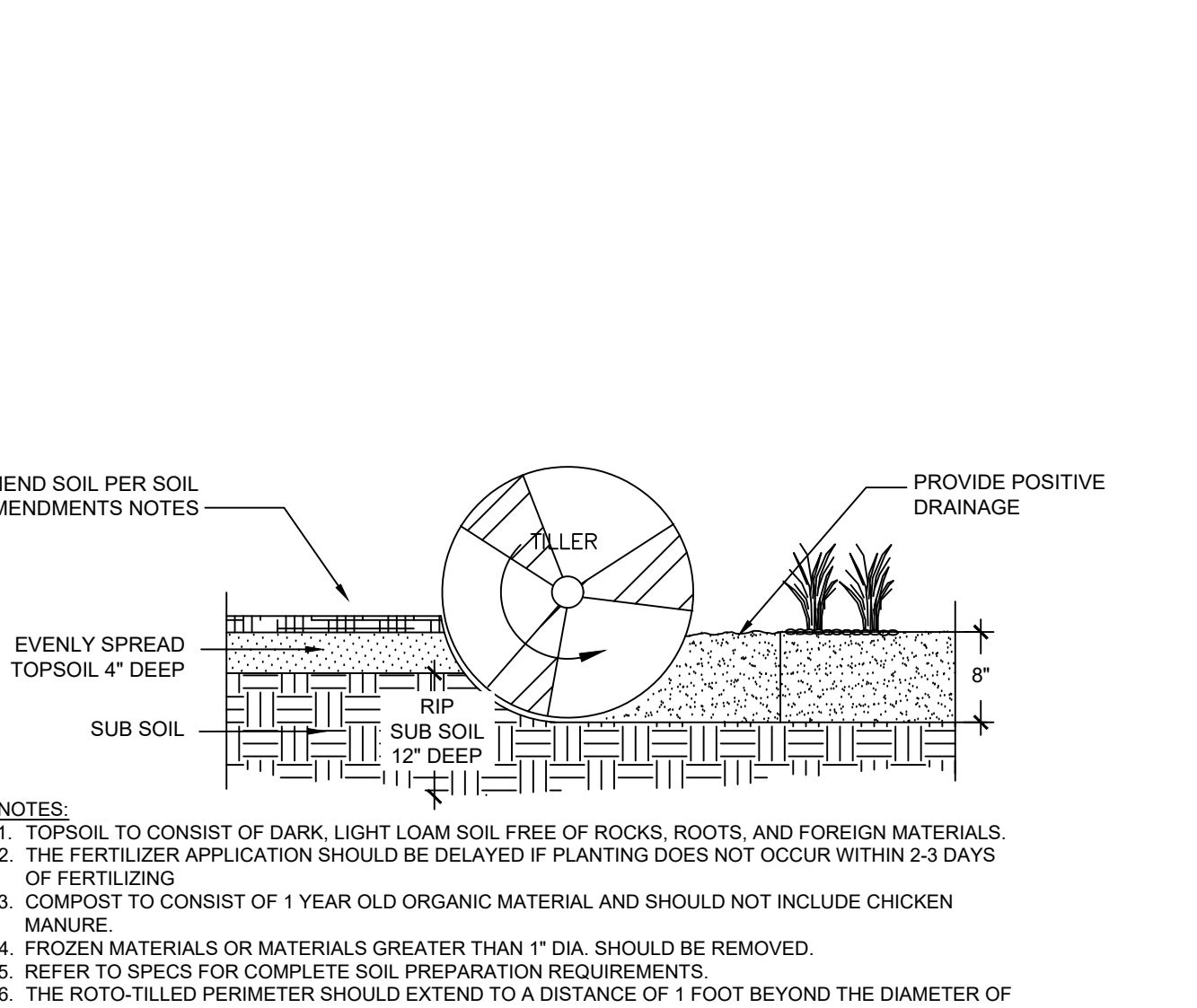

**5 SOIL PREP**  
NTS 096-636-005-01

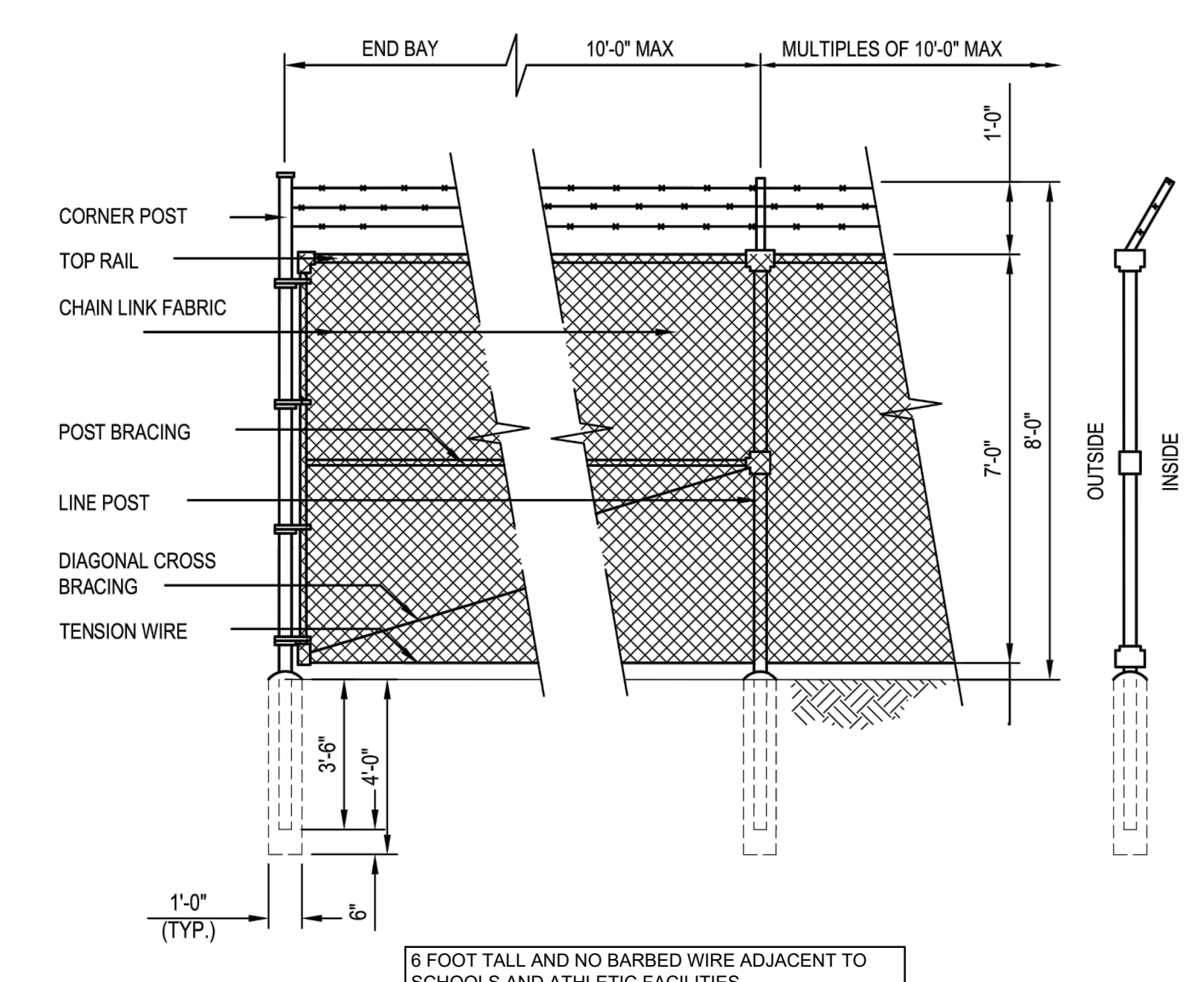

**1 FENCE DETAIL**  
 NTS

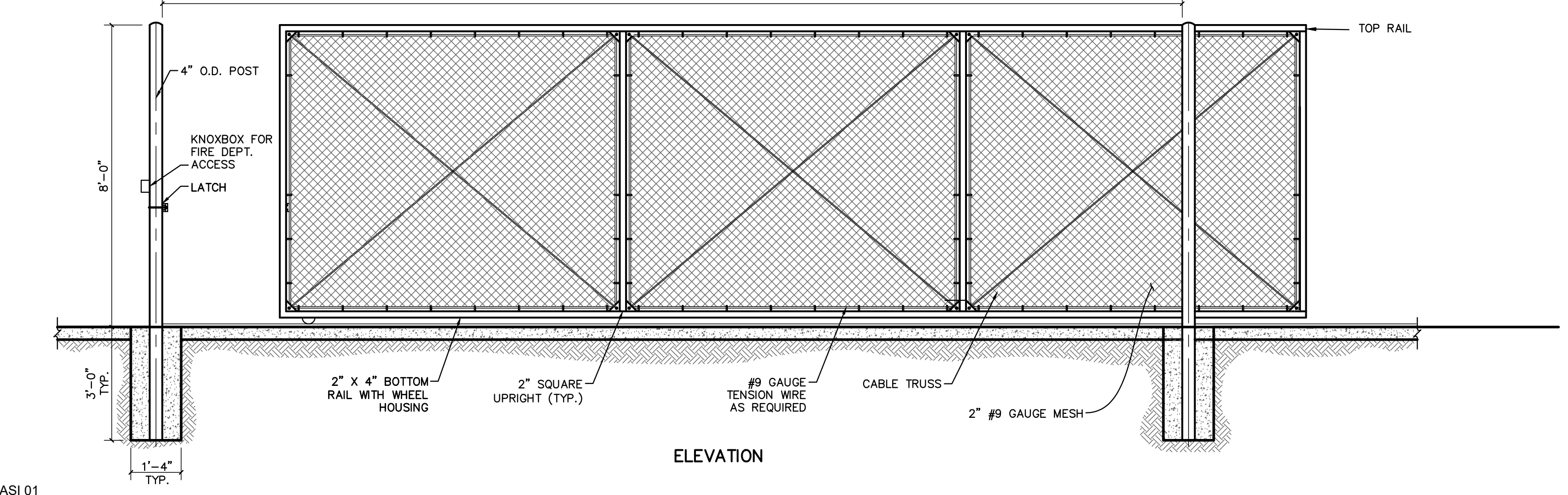
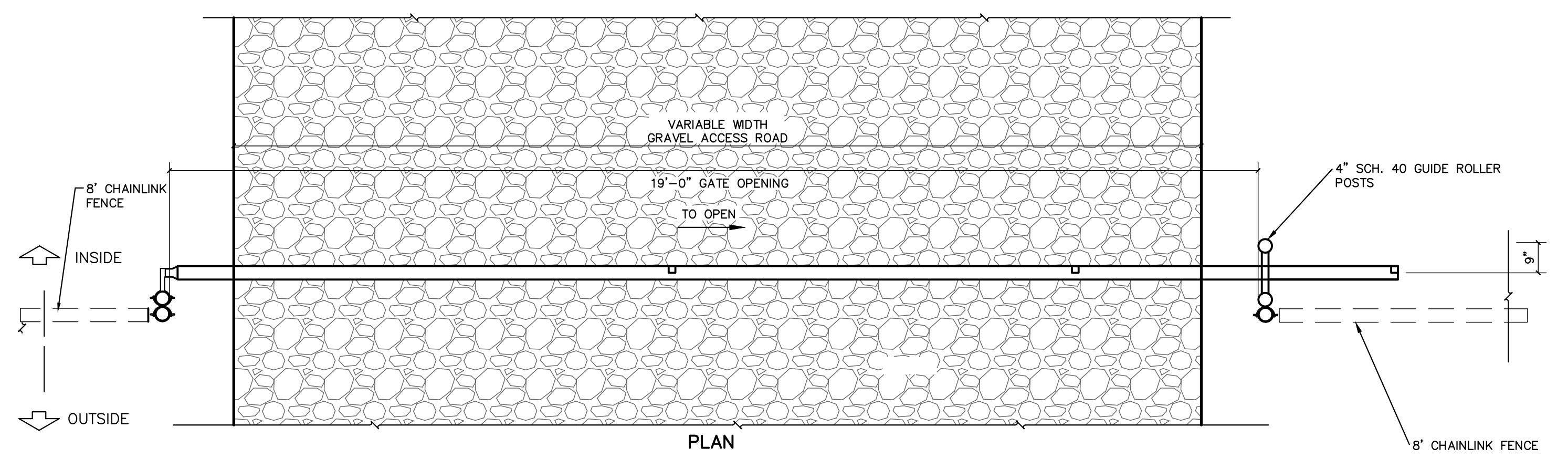

**2 ONE-WAY ROLLING GATE**  
 NTS

**NOTE:**

1. SLIDING ENTRY SHALL BE MANUALLY OPERATED AND LOCKABLE. CONTRACTOR SHALL BE RESPONSIBLE FOR SELECTING HARDWARE BASED ON 19-FOOT OPENING WIDTH AND GATE WEIGHT.
2. SLIDE GATE SHALL HAVE "GATE WARNING" PLACARDS FULLY VISIBLE TO THE APPROACH ON BOTH SIDES OF THE GATE PER UL-325.
3. 19-FOOT GATE OPENING SHALL BE CENTERED ON GRAVEL ACCESS ROAD.
4. CONTRACTOR SHALL SUBMIT SHOP DRAWING OF SLIDING GATE TO LANDSCAPE ARCHITECT FOR APPROVAL PRIOR TO CONSTRUCTION.

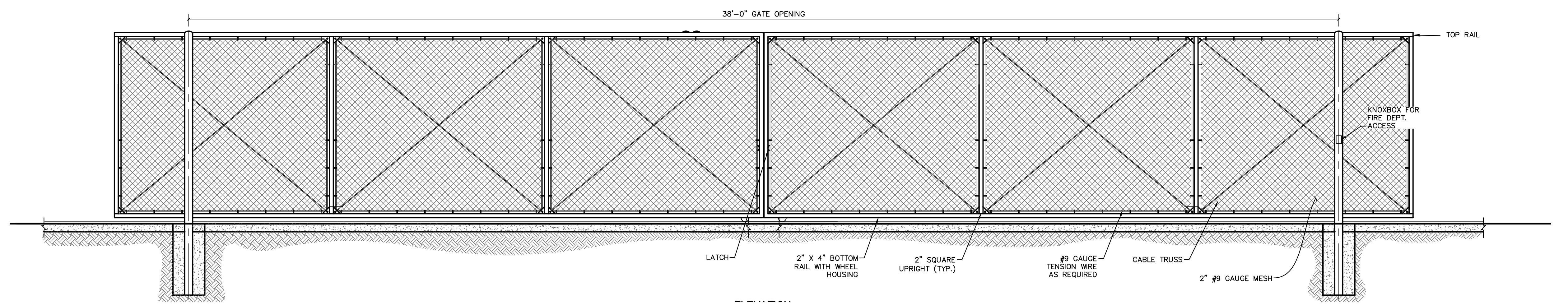
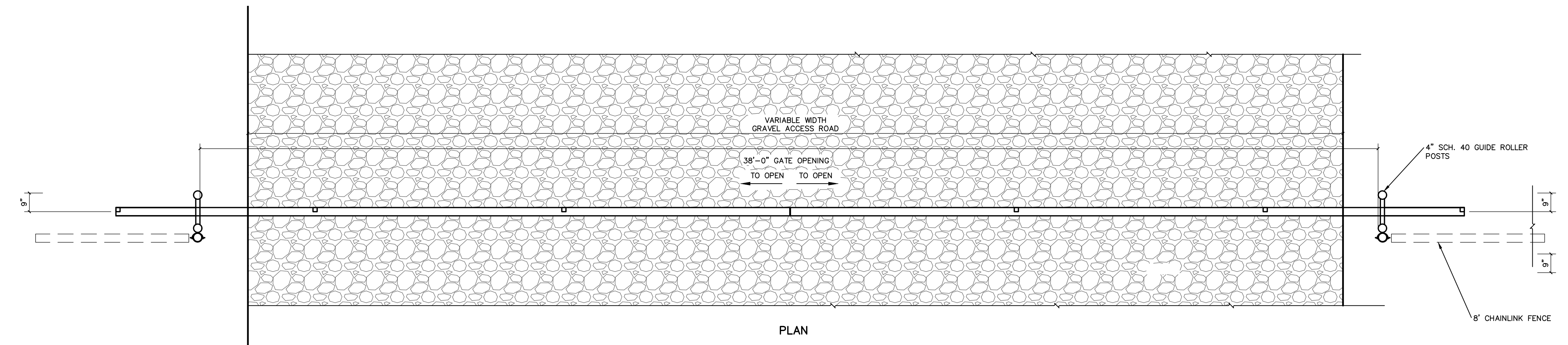

**3 TWO-WAY ROLLING GATE DETAIL**  
 NTS

**NOTE:**

1. SLIDING ENTRY SHALL BE MOTOR OPERATED. CONTRACTOR SHALL BE RESPONSIBLE FOR SIZING MOTOR BASED ON 38-FOOT OPENING WIDTH AND GATE WEIGHT.
2. NO DEVICE DESIGNED TO PROVIDE ACTIVATION FOR THE AUTOMATED GATE OPERATOR IS TO BE INSTALLED WITHIN 6-FEET OF THE HORIZONTAL PLANE OF THE GATE PANEL PER UL-325.
3. SLIDE GATE SHALL HAVE "GATE WARNING PLACARDS" FULLY VISIBLE TO THE APPROACH ON BOTH SIDES OF THE GATE PER UL-325.
4. 38-FOOT GATE OPENING SHALL BE CENTERED ON GRAVEL ACCESS ROAD.
5. CONTRACTOR TO VERIFY ALL ELECTRICAL REQUIREMENTS FOR GATE OPERATOR AND KEYPAD.
6. CONTRACTOR SHALL SUBMIT SHOP DRAWING OF SLIDING GATE TO LANDSCAPE ARCHITECT FOR APPROVAL PRIOR TO CONSTRUCTION.

**D49 TRANSPORTATION CENTER**

**SCHOOL DISTRICT NO 49**  
 11971 SWINGLINE ROAD  
 PEYTON, CO 80831

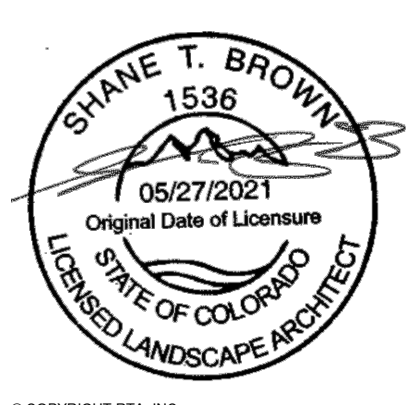

**LANDSCAPE DETAILS**

DATE PROJECT NUMBER  
 05/23/2022 2021-041.00

REVISIONS

#	DATE	DESCRIPTION	ADD IT
1	06/02/2022		

DESIGNED BY: JH  
 DRAWN BY: AK  
 CHECKED BY: SB

ISSUED FOR: CONSTRUCTION DOCUMENTS

SHEET NO. L-104

### IRRIGATION SCHEDULE

SYMBOL	MANUFACTURER/MODEL/DESCRIPTION	QTY	PSI	GPM	RADIUS
↔	RAIN BIRD RWS M-B-C W/ RWS-SOCK 1401 MINI ROOT WATERING SYSTEM WITH 4" DIAMETER X 18" LONG WITH LOCKING GRATE, SEMI-RIGID MESH TUBE AND RAIN BIRD 1401 0.25 GPM OR 1402 0.5 GPM BUBBLER AS INDICATED. WITH CHECK VALVE, AND SAND SOCK FOR SANDY SOIL.	46	30		
⊗	HUNTER I-25-04-SS 08 TURF ROTOR, 4" POP-UP, ADJUSTABLE AND FULL CIRCLE. STAINLESS STEEL RISER, DRAIN CHECK VALVE, STANDARD NOZZLE.	32	40	7.7	47'
■	RAIN BIRD XCZ-100-PRB-COM WIDE FLOW DRIP CONTROL KIT FOR COMMERCIAL APPLICATIONS. 1" BALL VALVE WITH 1" PRESSURE REGULATING 40PSI QUICK-CHECK BASKET FILTER. 0.3 GPM-20 GPM	2			
+	AREA TO RECEIVE DRIP EMITTERS RAIN BIRD XB-PC SINGLE OUTLET, PRESSURE COMPENSATING DRIP EMITTERS. FLOW RATES OF 0.5 GPH-BLUE, 1.0 GPH-BLACK, AND 2.0 GPH-RED. COMES WITH A SELF-PIERCING BARB INLET X BARB OUTLET. Emitter Notes: 1.0 GPH emitters (2 assigned to each 5 GAL plant)	3,894 S.F.			
⊕	RAIN BIRD PEB (2) 1", 1-1/2", 2" PLASTIC INDUSTRIAL VALVES. LOW FLOW OPERATING CAPABILITY, GLOBE CONFIGURATION.	6			
⊕	RAIN BIRD 44-LRC-OC 1" BRASS QUICK-COUPLING VALVE, WITH CORROSION-RESISTANT STAINLESS STEEL SPRING, LOCKING THERMOPLASTIC RUBBER COVER, AND 2-PIECE BODY.	9			
⊕	RAIN BIRD PEB 1" 1", 1-1/2", 2" PLASTIC INDUSTRIAL VALVES. LOW FLOW OPERATING CAPABILITY, GLOBE CONFIGURATION.	1			
⊕	FEBCO 825Y 1" REDUCED PRESSURE BACKFLOW PREVENTER	1			
⊕	RAIN BIRD ESP12LXMEF-LXMMSS 12 STATION, TRADITIONALLY-WIRED, FLOW SMART (MODULE INCLUDED), COMMERCIAL CONTROLLER. INDOOR/OUTDOOR, PLASTIC WALL-MOUNT ENCLOSURE. INSTALL IN LXMMSS STAINLESS STEEL, WALL-MOUNTED CABINET.	1			
⊕	RAIN BIRD WR2-RFS WIRELESS RAIN/FREEZE SENSOR	1			
⊕	RAIN BIRD FS-100-B 1" FLOW SENSOR FOR USE WITH RAIN BIRD MAXICOM, SITECONTROL, AND ESP-LXD CENTRAL CONTROL SYSTEMS. BRASS MODEL, SUGGESTED OPERATING RANGE OF 2.0 GPM TO 40.0 GPM. SENSORS SHOULD BE SIZED FOR FLOW RATHER THAN PIPE SIZE.	1			
⊕	WATER METER 1-1/2"	1			
⊕	POINT OF CONNECTION 1 1/2" (EXISTING- CONTRACTOR TO LOCATE AND VERIFY)	1			
---	IRRIGATION LATERAL LINE: PVC CLASS 200 SDR 21 PVC CLASS 200 IRRIGATION PIPE. ONLY LATERAL TRANSITION PIPE SIZES 3.387 L.F. 1" AND ABOVE ARE INDICATED ON THE PLAN, WITH ALL OTHERS BEING 3/4" IN SIZE.	3,387 L.F.			
---	IRRIGATION MAINLINE: PVC SCHEDULE 40	2,576 L.F.			
---	PIPE SLEEVE: PVC SCHEDULE 40	262.1 L.F.			

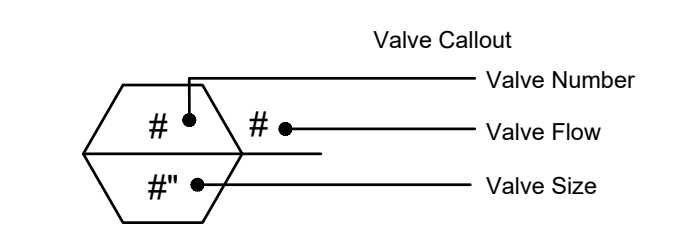

### CRITICAL ANALYSIS

Generated: 2022-09-27 15:58

P.O.C. NUMBER: 01  
 Water Source Information:

FLOW AVAILABLE  
 Point of Connection Size: 1 1/2"  
 Flow Available: 46.59 GPM

PRESSURE AVAILABLE  
 Static Pressure at POC: 80 PSI  
 Pressure Available: 80 PSI

DESIGN ANALYSIS  
 Maximum Station Flow: 11.5 GPM  
 Flow Available at POC: 46.59 GPM  
 Residual Flow Available: 35.09 GPM

Critical Station: 1  
 Design Pressure: 30 PSI  
 Friction Loss: 1.54 PSI  
 Fittings Loss: 0.19 PSI  
 Elevation Loss: 0 PSI  
 Loss through Valve: 9.01 PSI  
 Pressure Req. at Critical Station: 40.71 PSI  
 Loss for Fittings: 1.97 PSI  
 Loss for Main Line: 19.74 PSI  
 Loss for POC to Valve Elevation: 0 PSI  
 Loss for Backflow: 9.85 PSI  
 Critical Station Pressure at POC: 72.27 PSI  
 Pressure Available: 80 PSI  
 Residual Pressure Available: 7.73 PSI

P.O.C. NUMBER: 02  
 Water Source Information:

FLOW AVAILABLE  
 Water Meter Size: 1-1/2"  
 Flow Available: 75 GPM

PRESSURE AVAILABLE  
 Static Pressure at POC: 80 PSI  
 Elevation Change: 5.00 ft  
 Service Line Size: 3"  
 Length of Service Line: 20 ft  
 Pressure Available: 78 PSI

DESIGN ANALYSIS  
 Maximum Station Flow: 46.2 GPM  
 Flow Available at POC: 75 GPM  
 Residual Flow Available: 28.8 GPM

Critical Station: 7  
 Design Pressure: 40 PSI  
 Friction Loss: 2.68 PSI  
 Fittings Loss: 0.27 PSI  
 Elevation Loss: 0 PSI  
 Loss through Valve: 0 PSI  
 Pressure Req. at Critical Station: 42.95 PSI  
 Loss for Fittings: 0.64 PSI  
 Loss for Main Line: 0.64 PSI  
 Loss for POC to Valve Elevation: 0 PSI  
 Loss for Backflow: 0 PSI  
 Loss for Water Meter: 4.25 PSI  
 Critical Station Pressure at POC: 54.2 PSI  
 Pressure Available: 78 PSI  
 Residual Pressure Available: 23.8 PSI

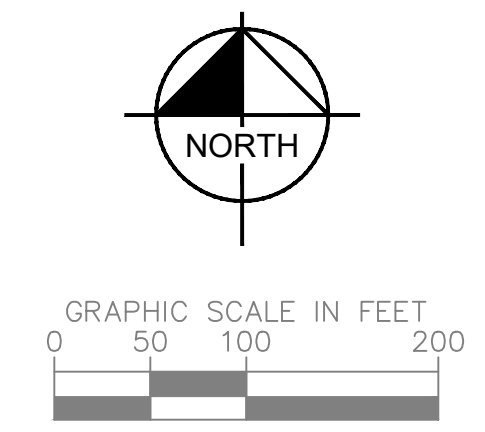

# SHEET IR-100

# SHEET IR-101

### VALVE SCHEDULE

NUMBER	MODEL	SIZE	TYPE	GPM	WIRE	PSI	PSI @ POC	PRECIP
1	RAIN BIRD XCZ-100-PRB-COM	1"	BUBBLER	11.5	504.0	40.7	72.3	0.86 in/h
2	RAIN BIRD XCZ-100-PRB-COM	1"	AREA FOR DRIP EMITTERS	6.07	317.1	34.9	47.5	0.39 in/h
3	RAIN BIRD PEB (2)	1-1/2"	TURF ROTOR	46.2		43.8	51.7	0.99 in/h
4	RAIN BIRD PEB (2)	1-1/2"	TURF ROTOR	38.5		42.7	49.4	0.9 in/h
5	RAIN BIRD PEB (2)	1-1/2"	TURF ROTOR	38.5		42.6	49.8	0.48 in/h
6	RAIN BIRD PEB (2)	1-1/2"	TURF ROTOR	38.5		42.6	50.4	0.52 in/h
7	RAIN BIRD PEB (2)	1-1/2"	TURF ROTOR	46.2		42.9	54.2	0.42 in/h
8	RAIN BIRD PEB (2)	1-1/2"	TURF ROTOR	38.5		43.7	51.9	0.85 in/h



### IRRIGATION SCHEDULE

SYMBOL	MANUFACTURER/MODEL/DESCRIPTION	QTY	PSI		
1401	RAIN BIRD RWS M-B-C W/ RWS-SOCK 1401 MINI ROOT WATERING SYSTEM WITH 4" DIAMETER X 18" LONG WITH LOCKING GRATE, SEMI-RIGID MESH TUBE AND RAIN BIRD 1401 0.25 GPM OR 1402 0.5 GPM BUBBLER AS INDICATED. WITH CHECK VALVE, AND SAND SOCK FOR SANDY SOIL.	46	30		
SYMBOL	MANUFACTURER/MODEL/DESCRIPTION	QTY	PSI	GPM	RADIUS
108	HUNTER I-25-04-SS 08 TURF ROTOR, 4" POP-UP, ADJUSTABLE AND FULL CIRCLE. STAINLESS STEEL RISER, DRAIN CHECK VALVE, STANDARD NOZZLE.	32	40	7.7	47"
SYMBOL	MANUFACTURER/MODEL/DESCRIPTION	QTY			
1402	RAIN BIRD XCZ-100-PRB-COM WIDE FLOW DRIP CONTROL KIT FOR COMMERCIAL APPLICATIONS. 1" BALL VALVE WITH 1" PEBB VALVE AND 1" PRESSURE REGULATING 40PSI QUICK-CHECK BASKET FILTER. 0.3 GPM-20 GPM	2			
+	AREA TO RECEIVE DRIP EMITTERS RAIN BIRD XB-PC SINGLE OUTLET, PRESSURE COMPENSATING DRIP EMITTERS. FLOW RATES OF 0.5 GPH-BLUE, 1.0 GPH-BLACK, AND 2.0 GPH-RED. COMES WITH A SELF-PIERCING BARB INLET X BARB OUTLET. Emitter Notes: 1.0 GPH emitters (2 assigned to each 5 GAL plant)	3,894 S.F.	292		
SYMBOL	MANUFACTURER/MODEL/DESCRIPTION	QTY			
1	RAIN BIRD PEB (2) 1", 1-1/2", 2" PLASTIC INDUSTRIAL VALVES. LOW FLOW OPERATING CAPABILITY, GLOBE CONFIGURATION.	6			
1	RAIN BIRD 44-LRC-CC 1" BRASS QUICK-COUPLING VALVE, WITH CORROSION-RESISTANT STAINLESS STEEL SPRING, LOCKING THERMOPLASTIC RUBBER COVER, AND 2-PIECE BODY.	9			
1	RAIN BIRD PEB 1" 1", 1-1/2", 2" PLASTIC INDUSTRIAL VALVES. LOW FLOW OPERATING CAPABILITY, GLOBE CONFIGURATION.	1			
1	FEBCO 825Y 1" REDUCED PRESSURE BACKFLOW PREVENTER	1			
1	RAIN BIRD ESP12LXMEF-LXMMSS 12 STATION, TRADITIONALLY WIRED, FLOW SMART (MODULE INCLUDED), COMMERCIAL CONTROLLER. INDOOR/OUTDOOR, PLASTIC WALL-MOUNT ENCLOSURE. INSTALL IN LXMMSS STAINLESS STEEL, WALL-MOUNTED CABINET.	1			
1	RAIN BIRD WR2-RFS WIRELESS RAIN/FREEZE SENSOR	1			
1	RAIN BIRD FS-100-B 1" FLOW SENSOR FOR USE WITH RAIN BIRD MAXICOM, SITECONTROL, AND ESP-LXD CENTRAL CONTROL SYSTEMS. BRASS MODEL, SUGGESTED OPERATING RANGE OF 2.0 GPM TO 40.0 GPM. SENSORS SHOULD BE SIZED FOR FLOW RATHER THAN PIPE SIZE.	1			
1	WATER METER 1-1/2"	1			
1	POINT OF CONNECTION 1 1/2" (EXISTING- CONTRACTOR TO LOCATE AND VERIFY)	1			
---	IRRIGATION LATERAL LINE: PVC CLASS 200 SDR 21	3,387 L.F.			
---	PVC CLASS 200 IRRIGATION PIPE, ONLY LATERAL TRANSITION PIPE SIZES 1" AND ABOVE ARE INDICATED ON THE PLAN, WITH ALL OTHERS BEING 3/4" IN SIZE.	2,576 L.F.			
---	IRRIGATION MAINLINE: PVC SCHEDULE 40	262.1 L.F.			
---	PIPE SLEEVE: PVC SCHEDULE 40				

### CRITICAL ANALYSIS

Generated: 2022-09-27 15:58

P.O.C. NUMBER: 01  
 Water Source Information:

FLOW AVAILABLE  
 Point of Connection Size: 1 1/2"  
 Flow Available: 46.59 GPM

PRESSURE AVAILABLE  
 Static Pressure at POC: 80 PSI  
 Pressure Available: 80 PSI

DESIGN ANALYSIS  
 Maximum Station Flow: 11.5 GPM  
 Flow Available at POC: 46.59 GPM  
 Residual Flow Available: 35.09 GPM

Critical Station: 1  
 Design Pressure: 30 PSI  
 Friction Loss: 1.54 PSI  
 Fittings Loss: 0.15 PSI  
 Elevation Loss: 0 PSI  
 Loss through Valve: 9.01 PSI  
 Pressure Req. at Critical Station: 40.71 PSI  
 Loss for Fittings: 1.97 PSI  
 Loss for Main Line: 19.74 PSI  
 Loss for POC to Valve Elevation: 0 PSI  
 Loss for Backflow: 9.85 PSI  
 Critical Station Pressure at POC: 72.27 PSI  
 Pressure Available: 80 PSI  
 Residual Pressure Available: 7.73 PSI

P.O.C. NUMBER: 02  
 Water Source Information:

FLOW AVAILABLE  
 Water Meter Size: 1-1/2"  
 Flow Available: 75 GPM

PRESSURE AVAILABLE  
 Static Pressure at POC: 80 PSI  
 Elevation Change: 5.00 ft  
 Service Line Size: 3"  
 Length of Service Line: 20 ft  
 Pressure Available: 78 PSI

DESIGN ANALYSIS  
 Maximum Station Flow: 46.2 GPM  
 Flow Available at POC: 75 GPM  
 Residual Flow Available: 28.8 GPM

Critical Station: 7  
 Design Pressure: 40 PSI  
 Friction Loss: 2.58 PSI  
 Fittings Loss: 0.27 PSI  
 Elevation Loss: 0 PSI  
 Loss through Valve: 0 PSI  
 Pressure Req. at Critical Station: 42.95 PSI  
 Loss for Fittings: 0.64 PSI  
 Loss for Main Line: 6.36 PSI  
 Loss for POC to Valve Elevation: 0 PSI  
 Loss for Backflow: 0 PSI  
 Loss for Water Meter: 4.25 PSI  
 Critical Station Pressure at POC: 54.2 PSI  
 Pressure Available: 78 PSI  
 Residual Pressure Available: 23.8 PSI

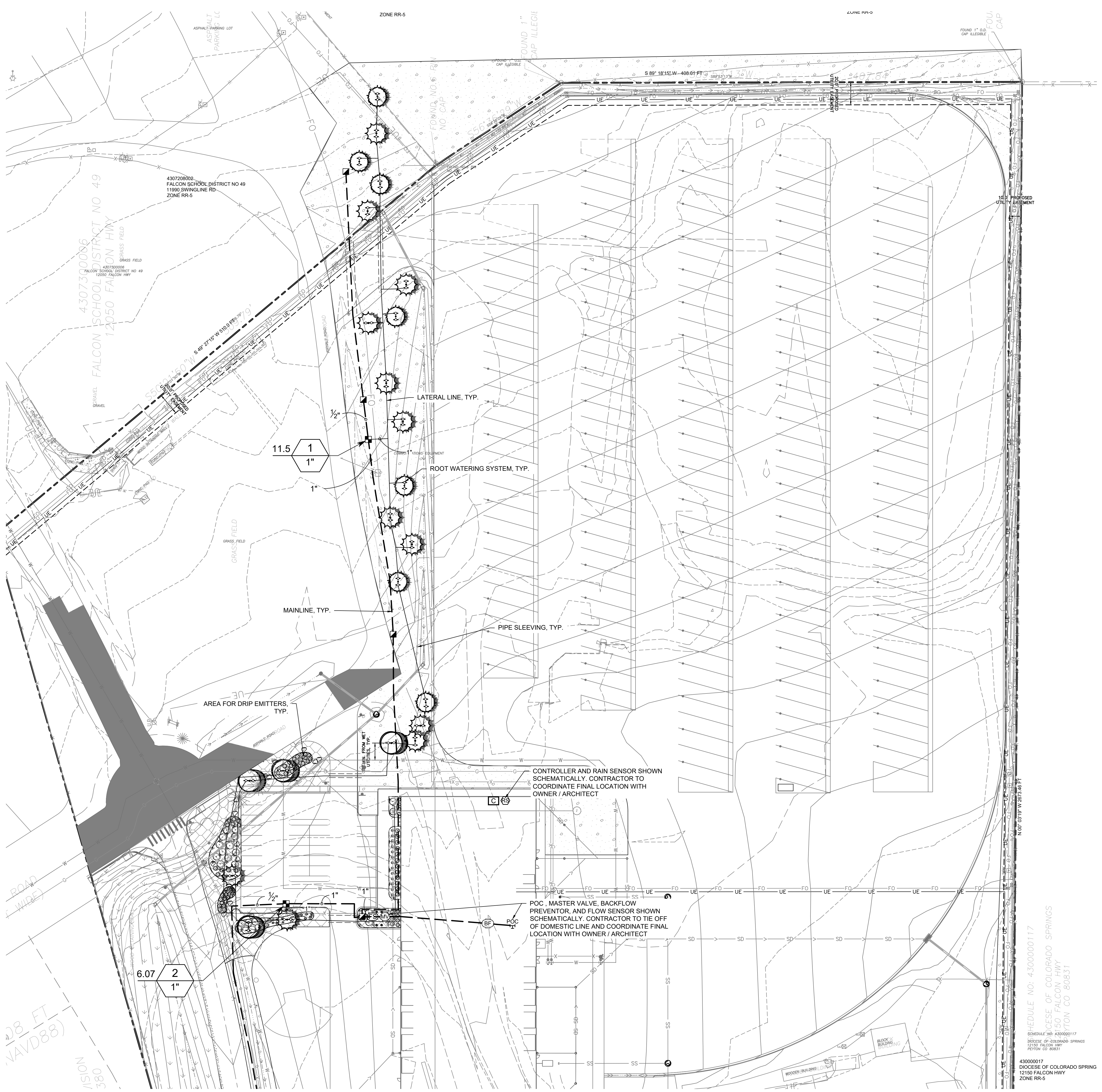

### VALVE SCHEDULE

NUMBER	MODEL	SIZE	TYPE	GPM	WIRE	PSI	PSI @ POC	PRECIP
1	RAIN BIRD XCZ-100-PRB-COM	1"	BUBBLER	11.5	504.0	40.7	72.3	0.86 in/h
2	RAIN BIRD XCZ-100-PRB-COM	1"	AREA FOR DRIP EMITTERS	6.07	317.1	34.9	47.5	0.39 in/h
3	RAIN BIRD PEB (2)	1-1/2"	TURF ROTOR	46.2		43.8	51.7	0.99 in/h
4	RAIN BIRD PEB (2)	1-1/2"	TURF ROTOR	38.5		42.7	49.4	0.9 in/h
5	RAIN BIRD PEB (2)	1-1/2"	TURF ROTOR	38.5		42.6	49.8	0.48 in/h
6	RAIN BIRD PEB (2)	1-1/2"	TURF ROTOR	38.5		42.6	50.4	0.52 in/h
7	RAIN BIRD PEB (2)	1-1/2"	TURF ROTOR	46.2		42.9	54.2	0.42 in/h
8	RAIN BIRD PEB (2)	1-1/2"	TURF ROTOR	38.5		43.2	51.9	0.85 in/h
	Common Wire				2,576			

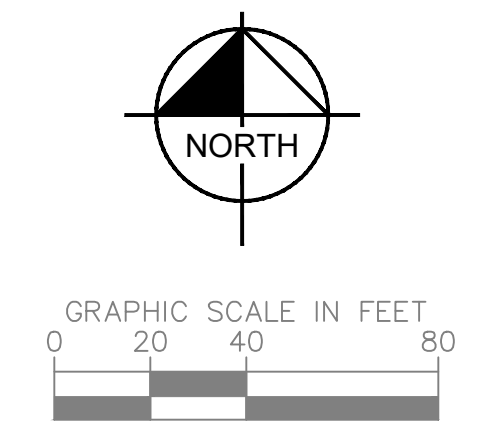



## IRRIGATION SCHEDULE

SYMBOL	MANUFACTURER/MODEL/DESCRIPTION	QTY	PSI		
1401 1402	RAIN BIRD RWS-M-5-C W/ RWS-SOCK 1401 MINI ROOT WATERING SYSTEM WITH 4" DIAMETER X 18" LONG WITH LOCKING GRATE, SEMI-RIGID MESH TUBE AND RAIN BIRD 1401 0.25 GPM OR 1402 0.5 GPM BUBBLER AS INDICATED. WITH CHECK VALVE, AND SAND SOCK FOR SANDY SOIL.	46	30		
SYMBOL	MANUFACTURER/MODEL/DESCRIPTION	QTY	PSI	GPM	RADIUS
1401	HUNTER I-25-04-SS 08 TURF ROTOR, 4" POP-UP, ADJUSTABLE AND FULL CIRCLE. STAINLESS STEEL RISER, DRAIN CHECK VALVE, STANDARD NOZZLE.	32	40	7.7	47"
SYMBOL	MANUFACTURER/MODEL/DESCRIPTION	QTY	PSI		
1401	RAIN BIRD XC2-100-PRB-COM WIDE FLOW DRIP CONTROL KIT FOR COMMERCIAL APPLICATIONS. 1" BALL VALVE WITH 1" PESB VALVE AND 1" PRESSURE REGULATING 40PSI QUICK-CHECK BASKET FILTER. 0.3 GPM-20 GPM	2			
+	AREA TO RECEIVE DRIP EMITTERS RAIN BIRD XB-CP SINGLE OUTLET, PRESSURE COMPENSATING DRIP EMITTERS. FLOW RATES OF 0.5 GPH=BLUE, 1.0 GPH=BLACK, AND 2.0 GPH=RED. COMES WITH A SELF-PIERCING BARB INLET X BARB OUTLET. Emitter Notes: 1.0 GPH emitters (2 assigned to each 5 GAL plant)	3,894 S.F.	292		
SYMBOL	MANUFACTURER/MODEL/DESCRIPTION	QTY	PSI		
1401	RAIN BIRD PEB (2) 1" - 1-1/2" 2" PLASTIC INDUSTRIAL VALVES. LOW FLOW OPERATING CAPABILITY, GLOBE CONFIGURATION.	6			
1401	RAIN BIRD 44-LRC-OC 1" BRASS QUICK-COUPLING VALVE, WITH CORROSION-RESISTANT STAINLESS STEEL SPRING, LOCKING THERMOPLASTIC RUBBER COVER, AND 2-PIECE BODY.	9			
1401	RAIN BIRD PEB 1" 1" - 1-1/2" 2" PLASTIC INDUSTRIAL VALVES. LOW FLOW OPERATING CAPABILITY, GLOBE CONFIGURATION.	1			
1401	FEB00 825Y 1" REDUCED PRESSURE BACKFLOW PREVENTER	1			
1401	RAIN BIRD ESP12LXMEF-LXMMSS 12 STATION, TRADITIONALLY WIRED, FLOW SMART (MODULE INCLUDED), COMMERCIAL CONTROLLER, INDOOR/OUTDOOR, PLASTIC WALL-MOUNT ENCLOSURE. INSTALL IN LXMMSS STAINLESS STEEL, WALL-MOUNTED CABINET.	1			
1401	RAIN BIRD WR2-RFS WIRELESS RAIN/FREEZE SENSOR.	1			
1401	RAIN BIRD FS-100-B 1" FLOW SENSOR FOR USE WITH RAIN BIRD MAXICOM, SITECONTROL, AND ESP-LXD CENTRAL CONTROL SYSTEMS. BRASS MODEL. SUGGESTED OPERATING RANGE OF 2.0 GPM TO 40.0 GPM. SENSORS SHOULD BE SIZED FOR FLOW RATHER THAN PIPE SIZE.	1			
1401	WATER METER 1-1/2"	1			
1401	POINT OF CONNECTION 1 1/2" (EXISTING- CONTRACTOR TO LOCATE AND VERIFY)	1			
IRRIGATION LATERAL LINE: PVC CLASS 200 SDR 21 PVC CLASS 200 IRRIGATION PIPE, ONLY LATERAL TRANSITION PIPE SIZES 1" AND ABOVE ARE INDICATED ON THE PLAN, WITH ALL OTHERS BEING 3/4" IN SIZE.		3,387 L.F.			
IRRIGATION MAINLINE: PVC SCHEDULE 40		2,576 L.F.			
PIPE SLEEVE: PVC SCHEDULE 40		262.1 L.F.			

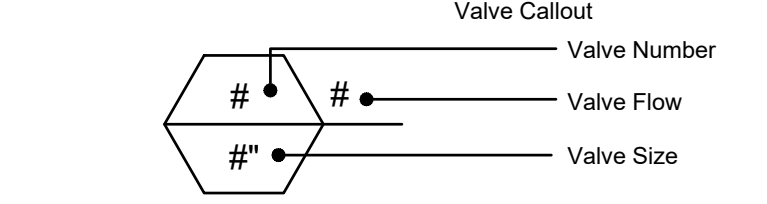

## CRITICAL ANALYSIS

Generated: 2022-09-27 15:58

P.O.C. NUMBER: 01  
 Water Source Information:

FLOW AVAILABLE  
 Point of Connection Size: 1 1/2"  
 Flow Available: 46.59 GPM

PRESSURE AVAILABLE  
 Static Pressure at POC: 80 PSI  
 Pressure Available: 80 PSI

DESIGN ANALYSIS  
 Maximum Station Flow: 11.5 GPM  
 Flow Available at POC: 46.59 GPM  
 Residual Flow Available: 35.09 GPM

Critical Station:  
 Design Pressure: 30 PSI  
 Friction Loss: 1.54 PSI  
 Fittings Loss: 0.15 PSI  
 Elevation Loss: 0 PSI  
 Loss through Valve: 9.01 PSI  
 Pressure Req. at Critical Station: 40.71 PSI  
 Loss for Fittings: 1.97 PSI  
 Loss for Main Line: 19.74 PSI  
 Loss for POC to Valve Elevation: 0 PSI  
 Loss for Backflow: 9.85 PSI  
 Critical Station Pressure at POC: 72.27 PSI  
 Pressure Available: 80 PSI  
 Residual Pressure Available: 7.73 PSI

P.O.C. NUMBER: 02  
 Water Source Information:

FLOW AVAILABLE  
 Water Meter Size: 1-1/2"  
 Flow Available: 75 GPM

PRESSURE AVAILABLE  
 Static Pressure at POC: 80 PSI  
 Elevation Change: 5.00 ft  
 Service Line Size: 3"  
 Length of Service Line: 20 ft  
 Pressure Available: 78 PSI

DESIGN ANALYSIS  
 Maximum Station Flow: 46.2 GPM  
 Flow Available at POC: 75 GPM  
 Residual Flow Available: 28.8 GPM

Critical Station:  
 Design Pressure: 7  
 Friction Loss: 40 PSI  
 Fittings Loss: 2.68 PSI  
 Elevation Loss: 0.27 PSI  
 Loss through Valve: 0 PSI  
 Pressure Req. at Critical Station: 42.95 PSI  
 Loss for Fittings: 0.64 PSI  
 Loss for Main Line: 6.36 PSI  
 Loss for POC to Valve Elevation: 0 PSI  
 Loss for Backflow: 0 PSI  
 Loss for Water Meter: 4.25 PSI  
 Critical Station Pressure at POC: 54.2 PSI  
 Pressure Available: 78 PSI  
 Residual Pressure Available: 23.8 PSI

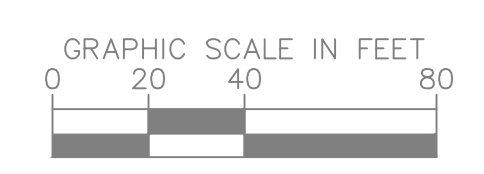
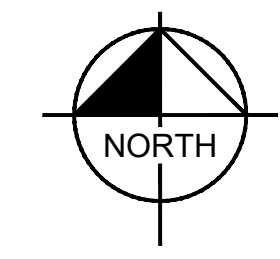

## VALVE SCHEDULE

NUMBER	MODEL	SIZE	TYPE	GPM	WIRE	PSI	PSI @ POC	PRECIP
1	RAIN BIRD XC2-100-PRB-COM	1"	BUBBLER	11.5	504.0	40.7	72.3	0.86 in/h
2	RAIN BIRD XC2-100-PRB-COM	1"	AREA FOR DRIP EMITTERS	6.07	317.1	34.9	47.5	0.39 in/h
3	RAIN BIRD PEB (2)	1-1/2"	TURF ROTOR	46.2		43.8	51.7	0.99 in/h
4	RAIN BIRD PEB (2)	1-1/2"	TURF ROTOR	38.5		42.7	49.4	0.9 in/h
5	RAIN BIRD PEB (2)	1-1/2"	TURF ROTOR	38.5		42.6	49.8	0.48 in/h
6	RAIN BIRD PEB (2)	1-1/2"	TURF ROTOR	38.5		42.6	50.4	0.52 in/h
7	RAIN BIRD PEB (2)	1-1/2"	TURF ROTOR	46.2		42.9	54.2	0.42 in/h
8	RAIN BIRD PEB (2)	1-1/2"	TURF ROTOR	38.5		43.2	51.9	0.85 in/h
Common Wire					2,576			

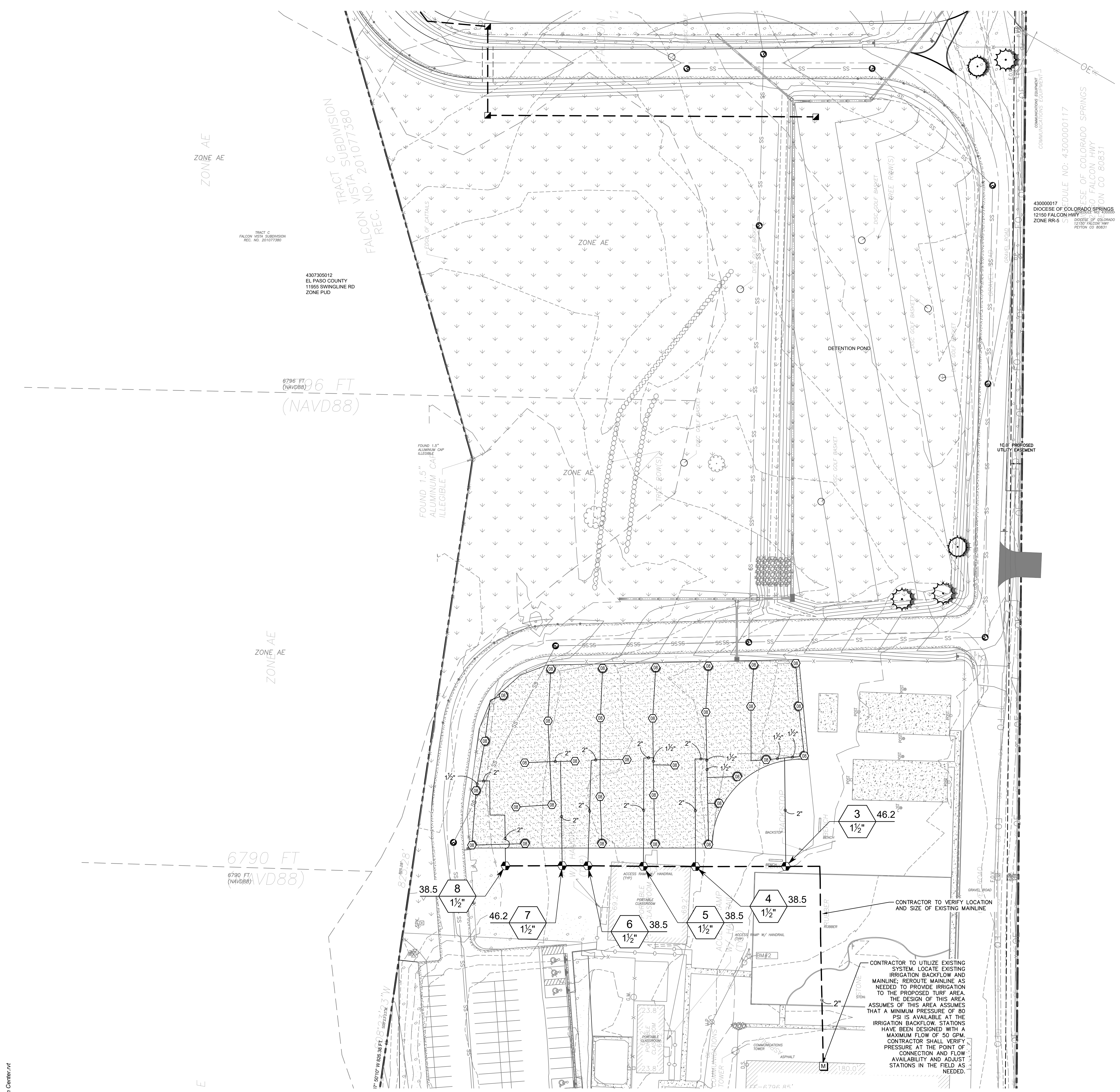

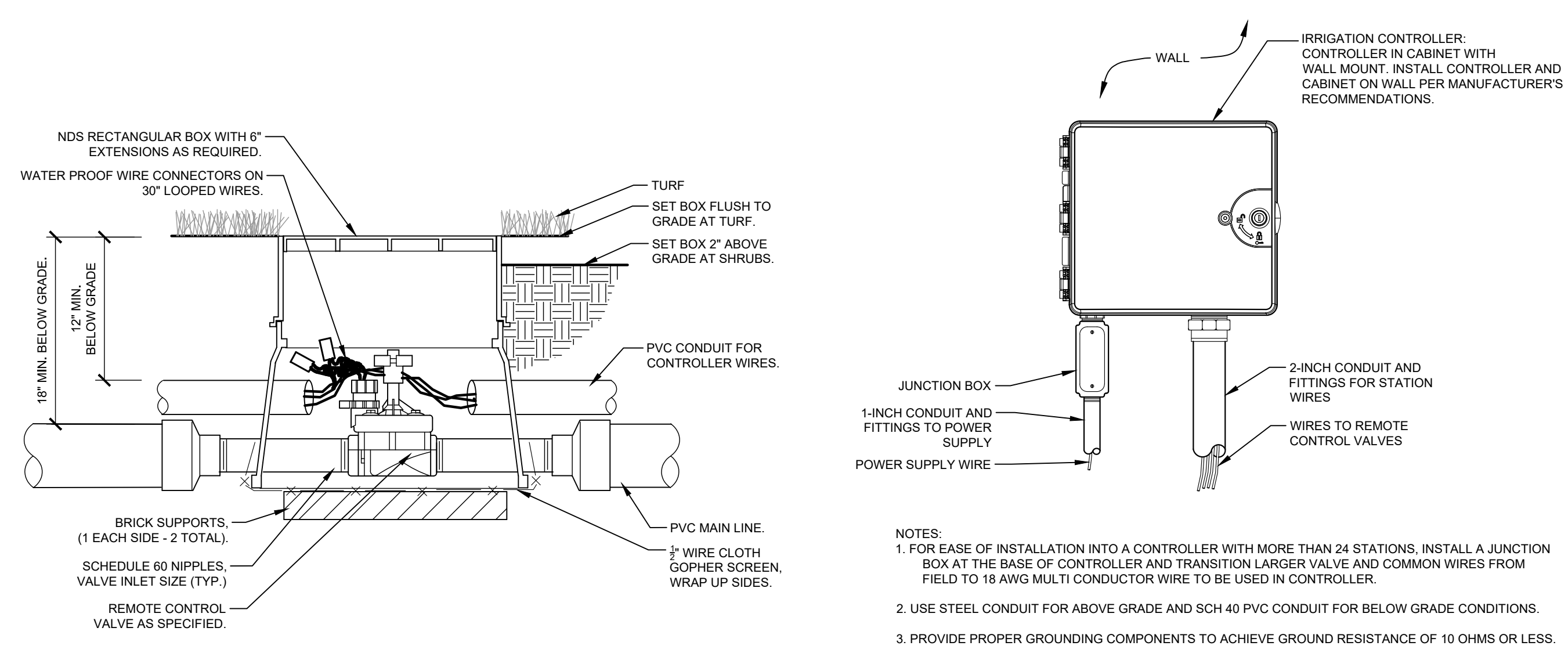

**1** REMOTE CONTROL VALVE  
 IR-102 SECTION NTS

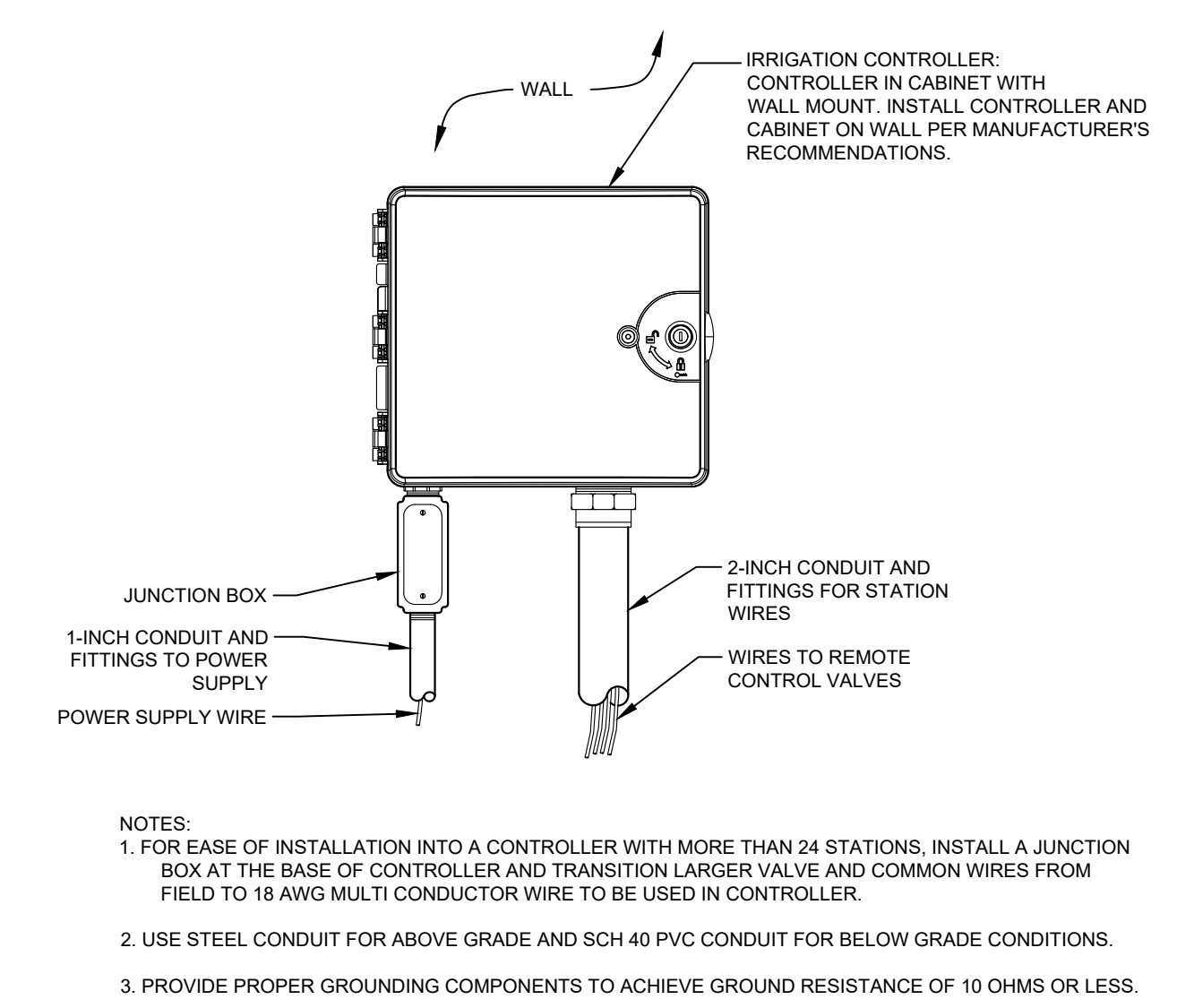

**2** IRRIGATION CONTROLLER - WALL MOUNT  
 IR-102 ELEVATION NTS

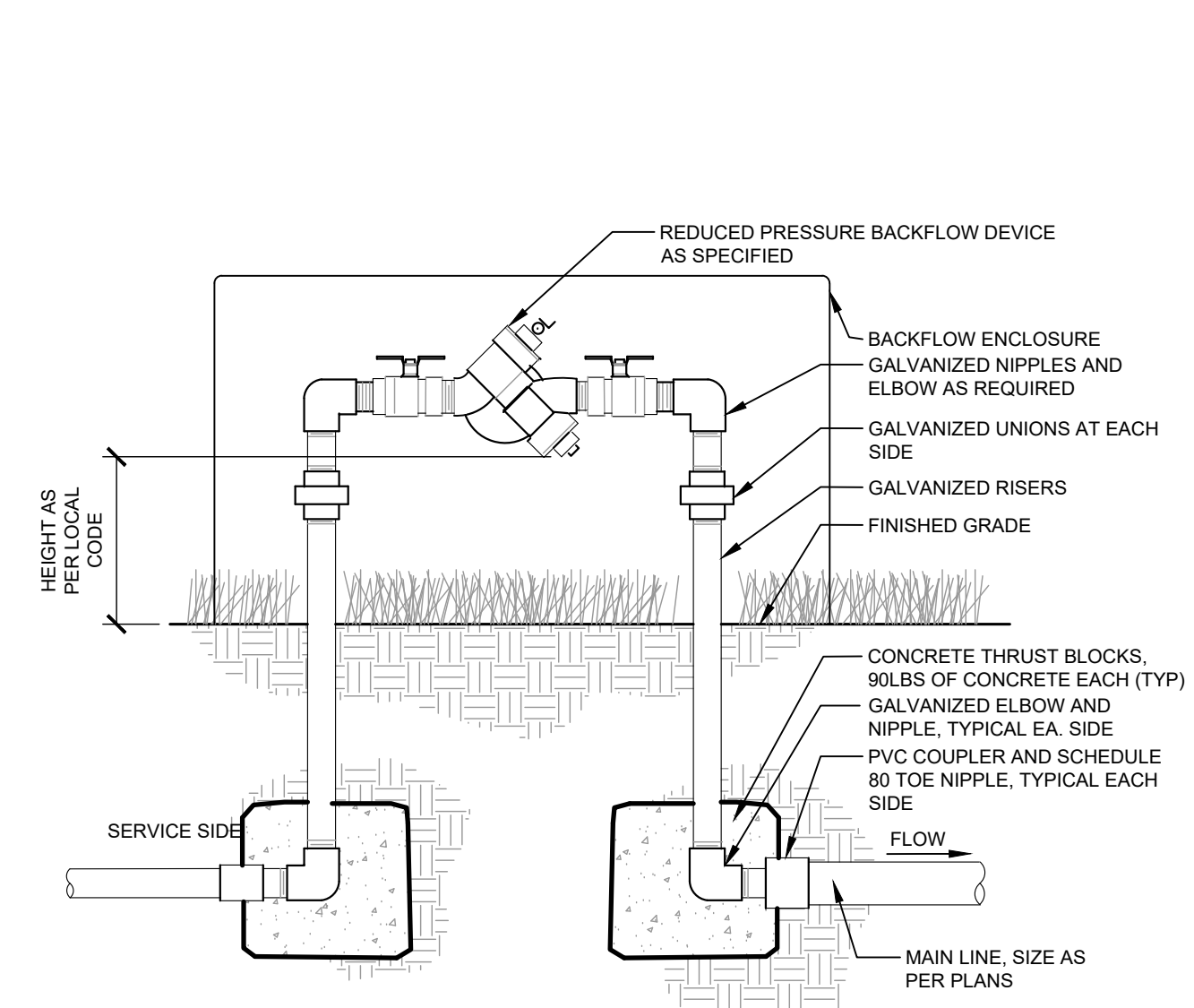

**3** BACKFLOW PREVENTER  
 IR-102 SECTION NTS

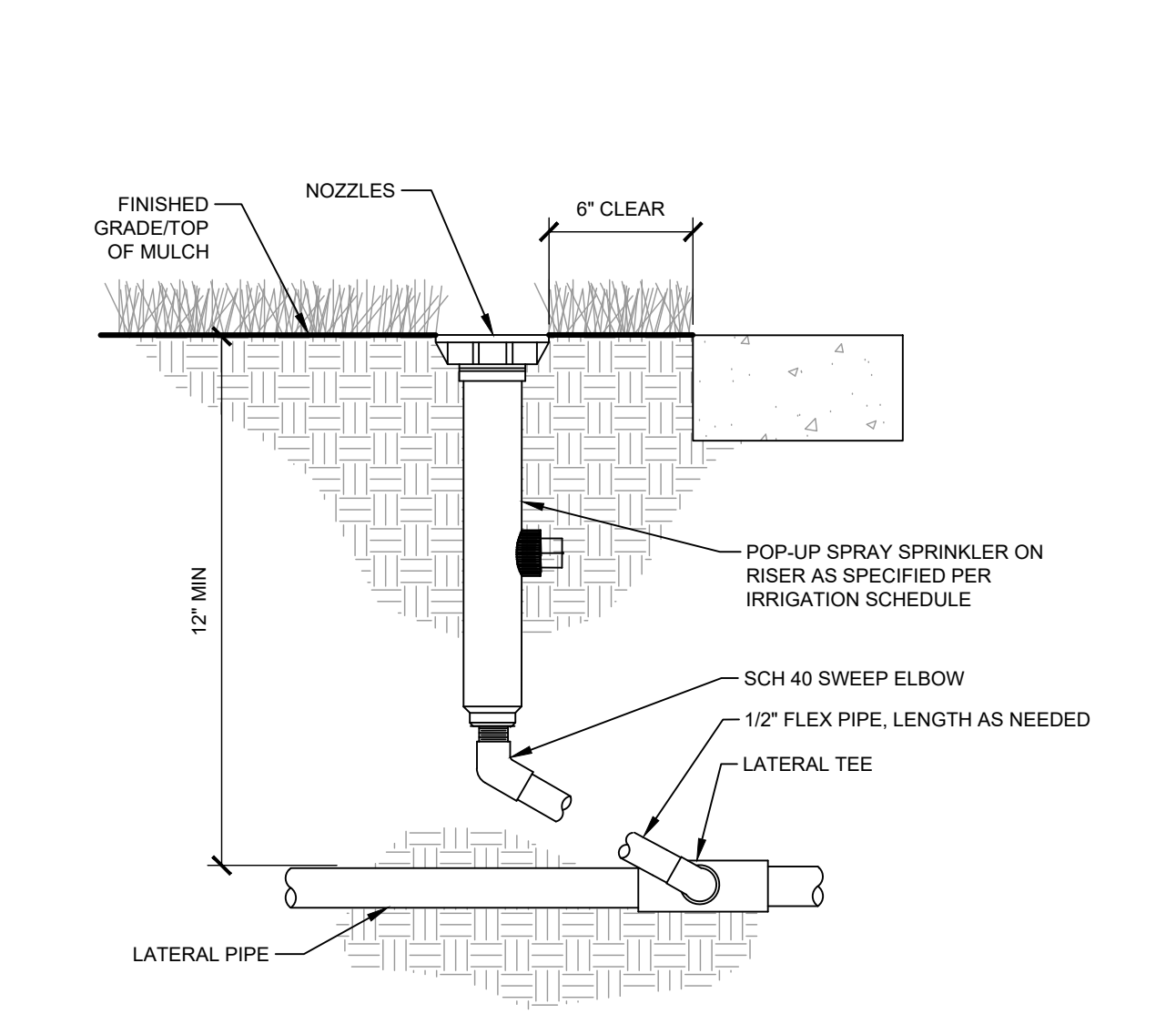

**4** TYPICAL SPRAY / ROTAR HEAD  
 IR-102 SECTION NTS

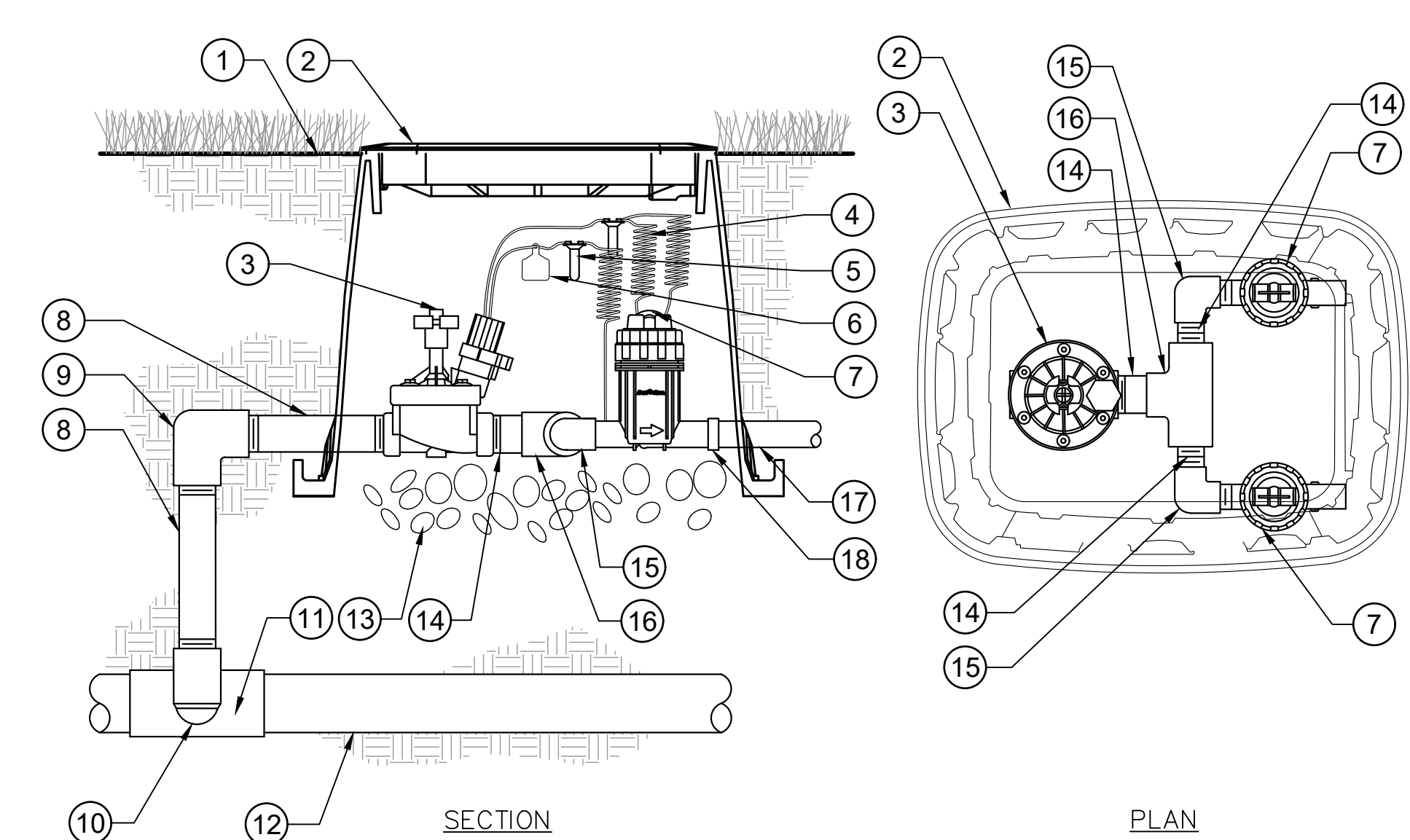

**5** DRIP ZONE VALVE KIT  
 IR-102 SECTION / PLAN NTS

- 1 FINISH GRADE/TOP OF MULCH
- 2 VALVE BOX WITH LOCKING COVER
- 3 REMOTE CONTROL VALVE
- 4 35-INCH LINEAR LENGTH OF WIRE, COILED
- 5 WATERPROOF CONNECTION
- 6 ID TAG
- 7 PRESSURE REGULATING QUICK CHECK BASKET FILTER
- 8 PVC SCH 80 NIPPLE (LENGTH AS REQUIRED)
- 9 PVC SCH 40 ELL
- 10 PVC SCH 80 NIPPLE (2-INCH LENGTH, HIDDEN) AND PVC SCH 40 ELL
- 11 PVC SCH 40 TEE OR ELL
- 12 MAINLINE PIPE
- 13 6-INCH MINIMUM DEPTH OF 3/4-INCH WASHED GRAVEL
- 14 PVC SCH 80 NIPPLE, CLOSE
- 15 PVC SCH 40 ELL
- 16 PVC SCH 40 TEE
- 17 LATERAL PIPE
- 18 PVC SCH 40 FEMALE ADAPTOR

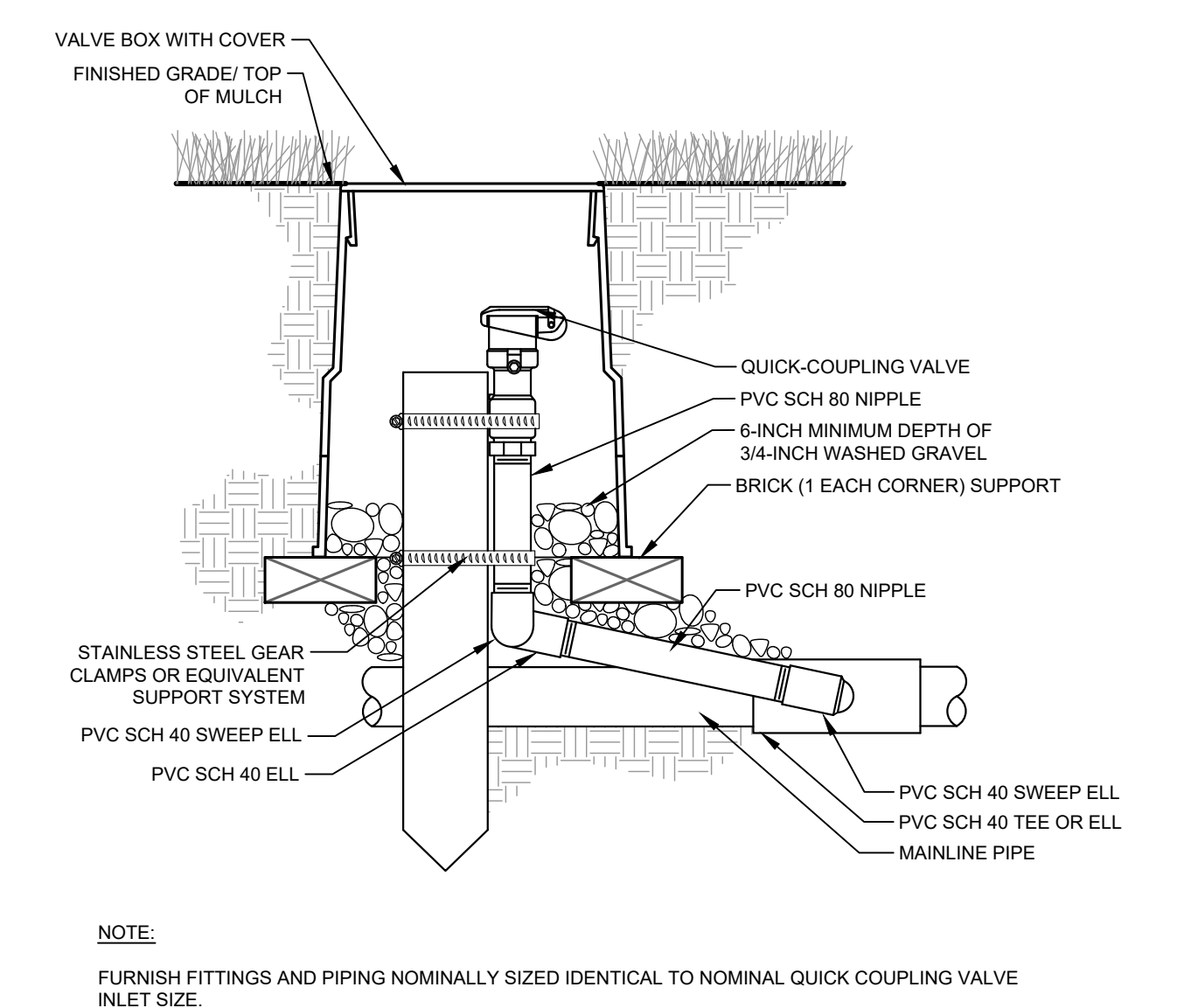

**6** TYPICAL QUICK COUPLER  
 IR-102 SECTION NTS

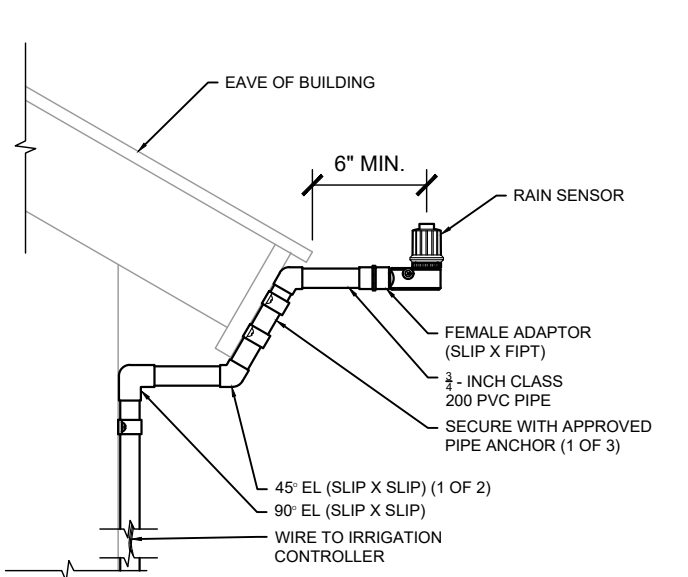

**7** RAIN SENSOR - BUILDING MOUNT  
 IR-102 SECTION NTS

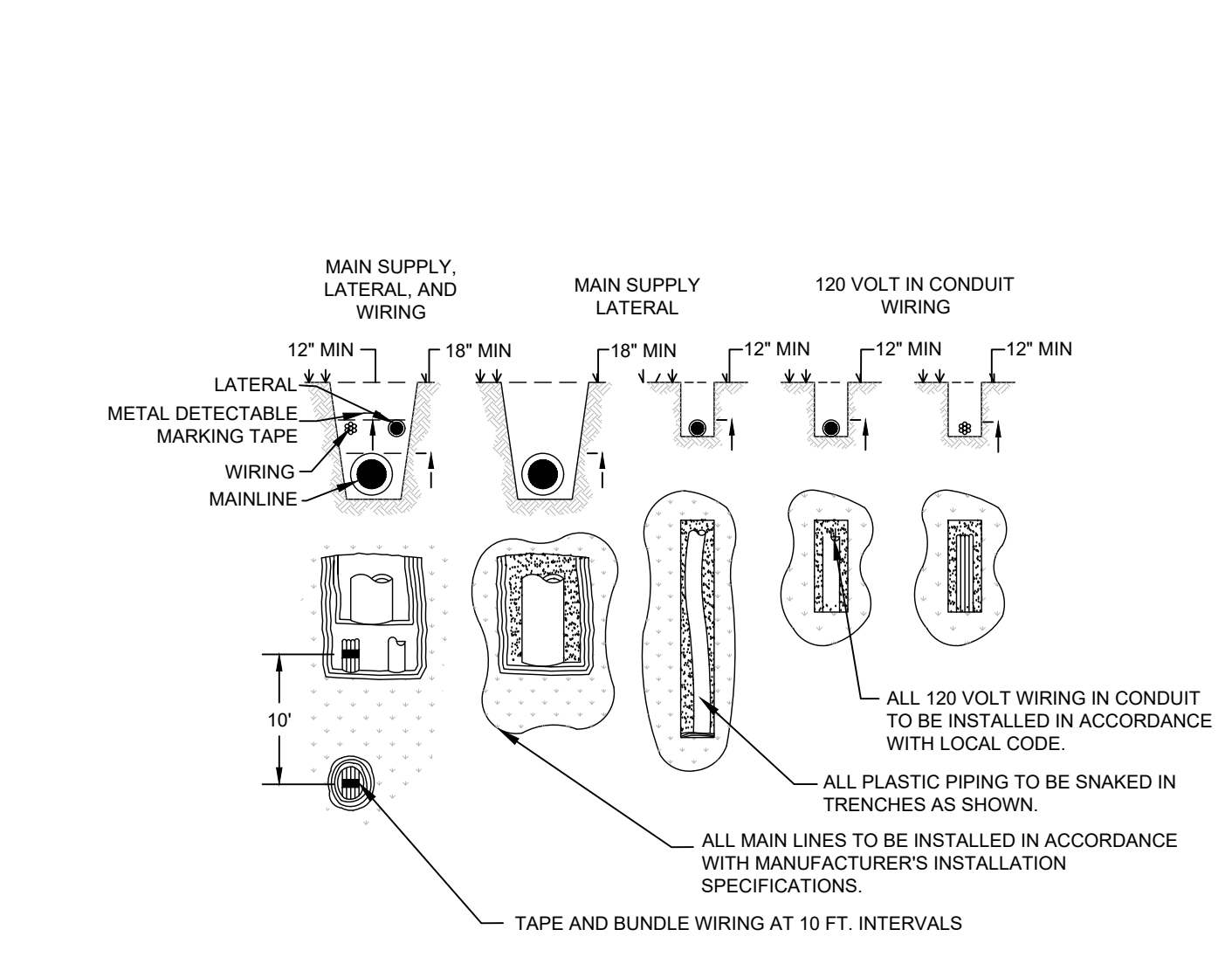

**8** TYPICAL TRENCHING  
 IR-102 SECTION NTS

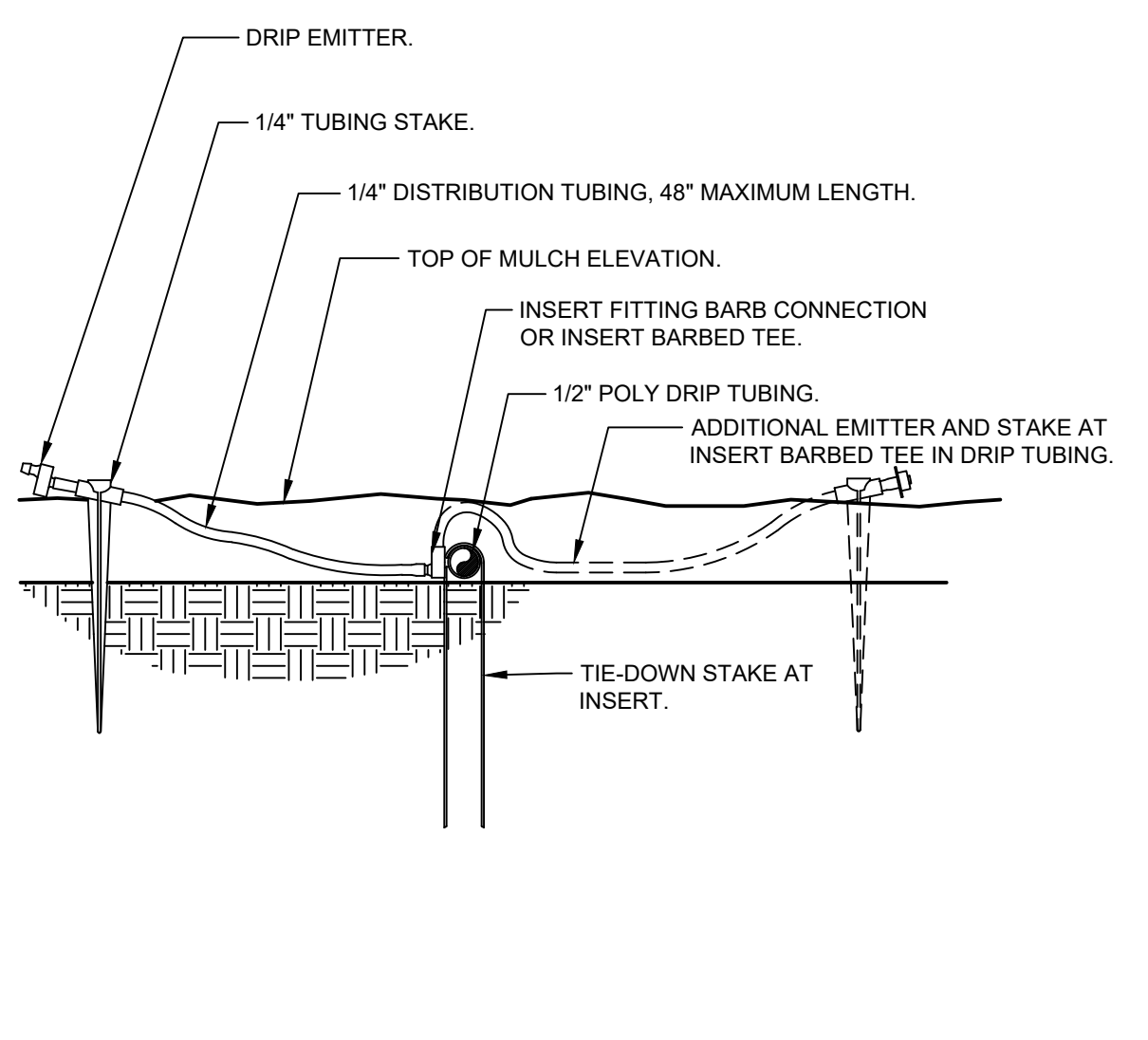

**9** DRIP EMITTER AT 1/4\"/>
 3\"/>

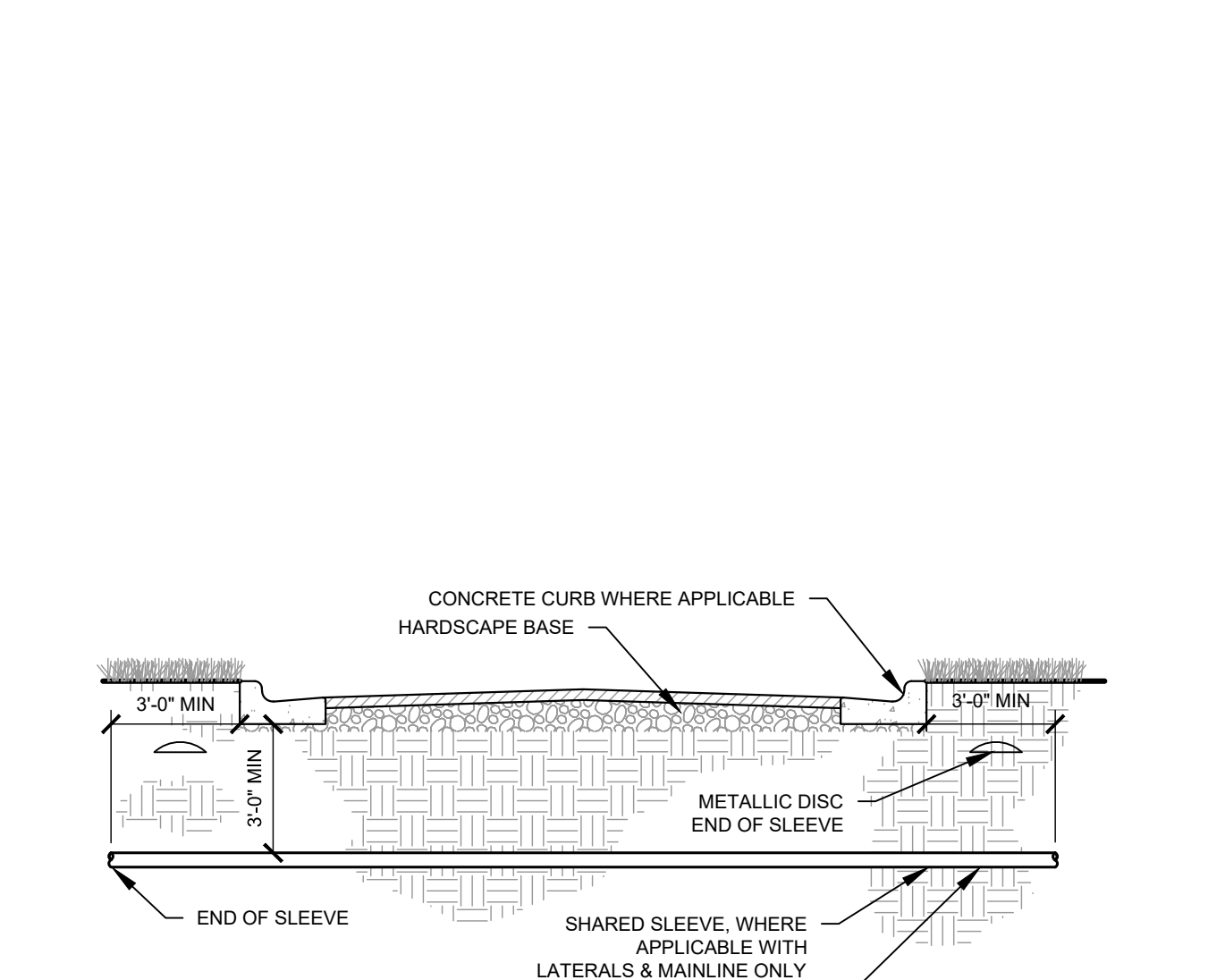

**10** TYPICAL SLEEVING  
 IR-102 SECTION NTS

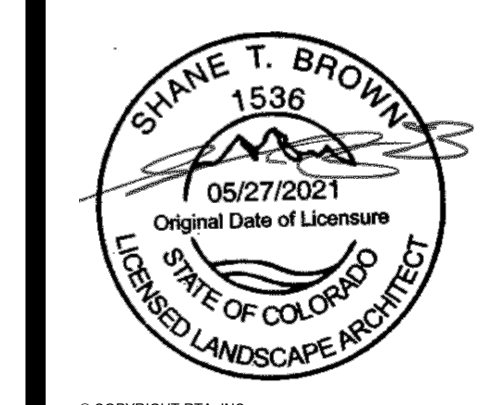

**Irrigation Details**

RTA PROJECT NUMBER  
**2021-041.00**  
 DATE  
**05/23/2022**  
 REVISIONS

#	DATE	DESCRIPTION
1	06/09/2022	ASB 01

ISSUES FOR  
**CONSTRUCTION DOCUMENTS**  
 SHEET NO.

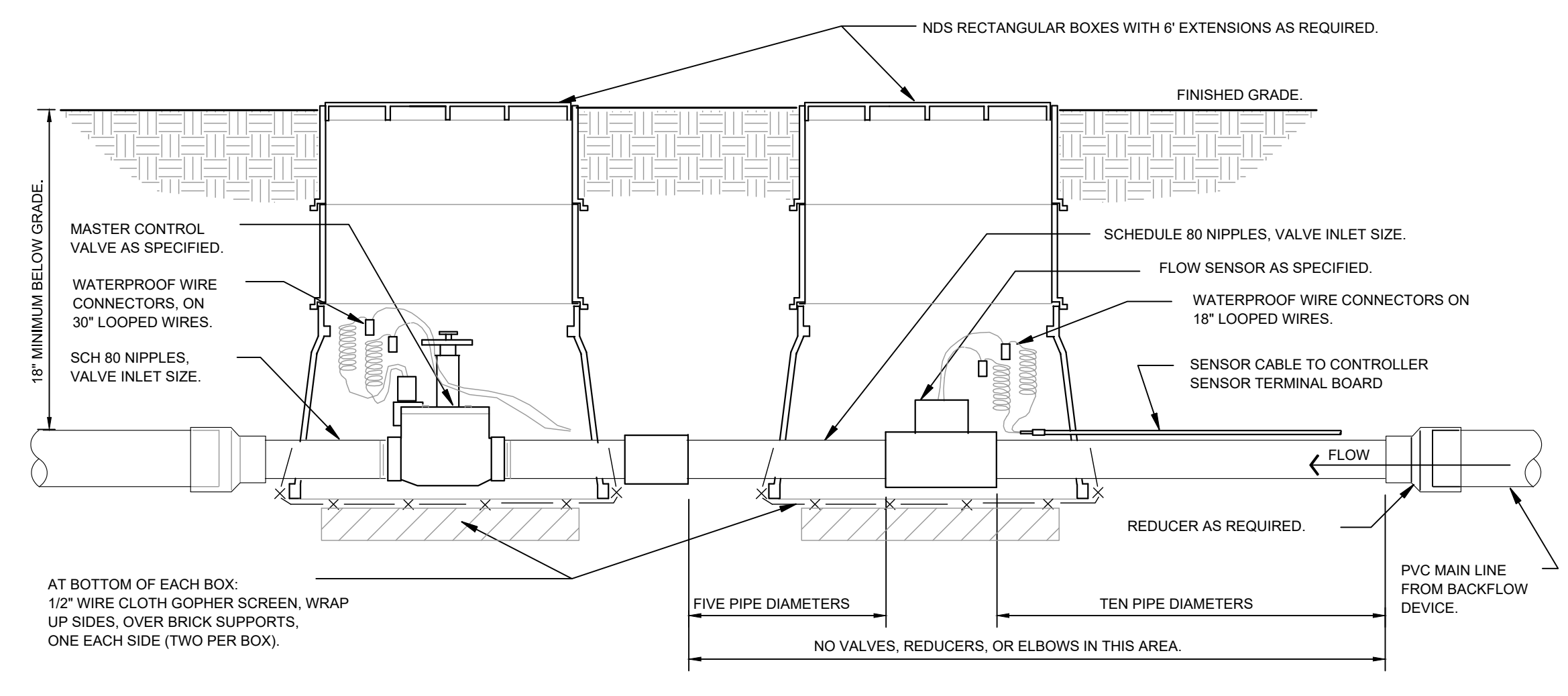

**1** MASTER CONTROL VALVE / FLOW SENSOR ASSEMBLY  
SECTION

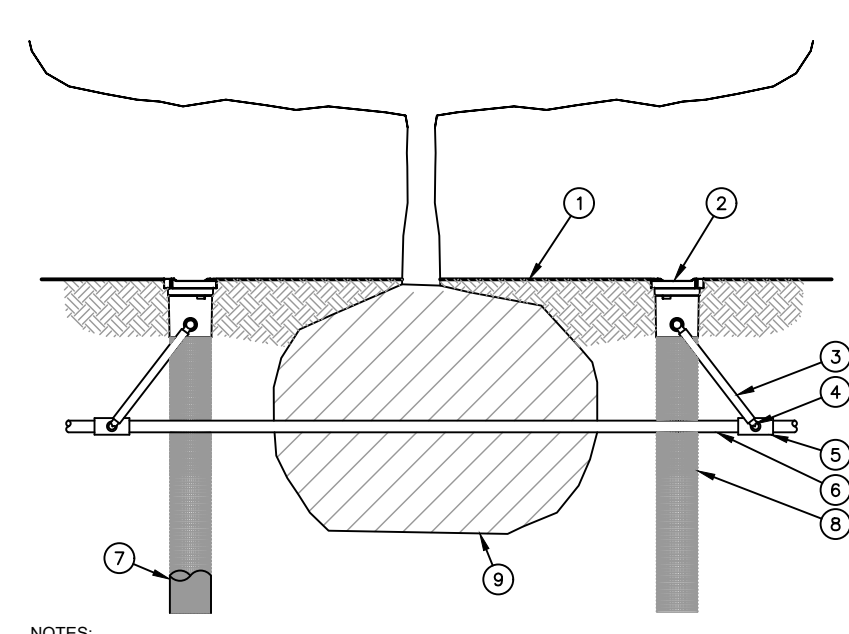

- NOTES:**
- POSITION 2-3 UNITS (OR MORE) EVENLY SPACED AROUND PLANT. FOR NEW TREES PLACE NEAR ROOT BALL. FOR EXISTING TREES PLACE HALF THE DISTANCE BETWEEN CANOPY EDGE AND TREE TRUNK.
  - INSTALL PRODUCT WITH TOP EVEN WITH GROUND SURFACE.
  - RWS SERIES AVAILABLE IN THE FOLLOWING MODELS:  
RWS-B-1401 0.25 GPM (0.95 L/M), CHECK VALVE  
RWS-B-1401 0.25 GPM (0.95 L/M)  
RWS-B-1401 0.25 GPM (0.95 L/M), 1\"/>

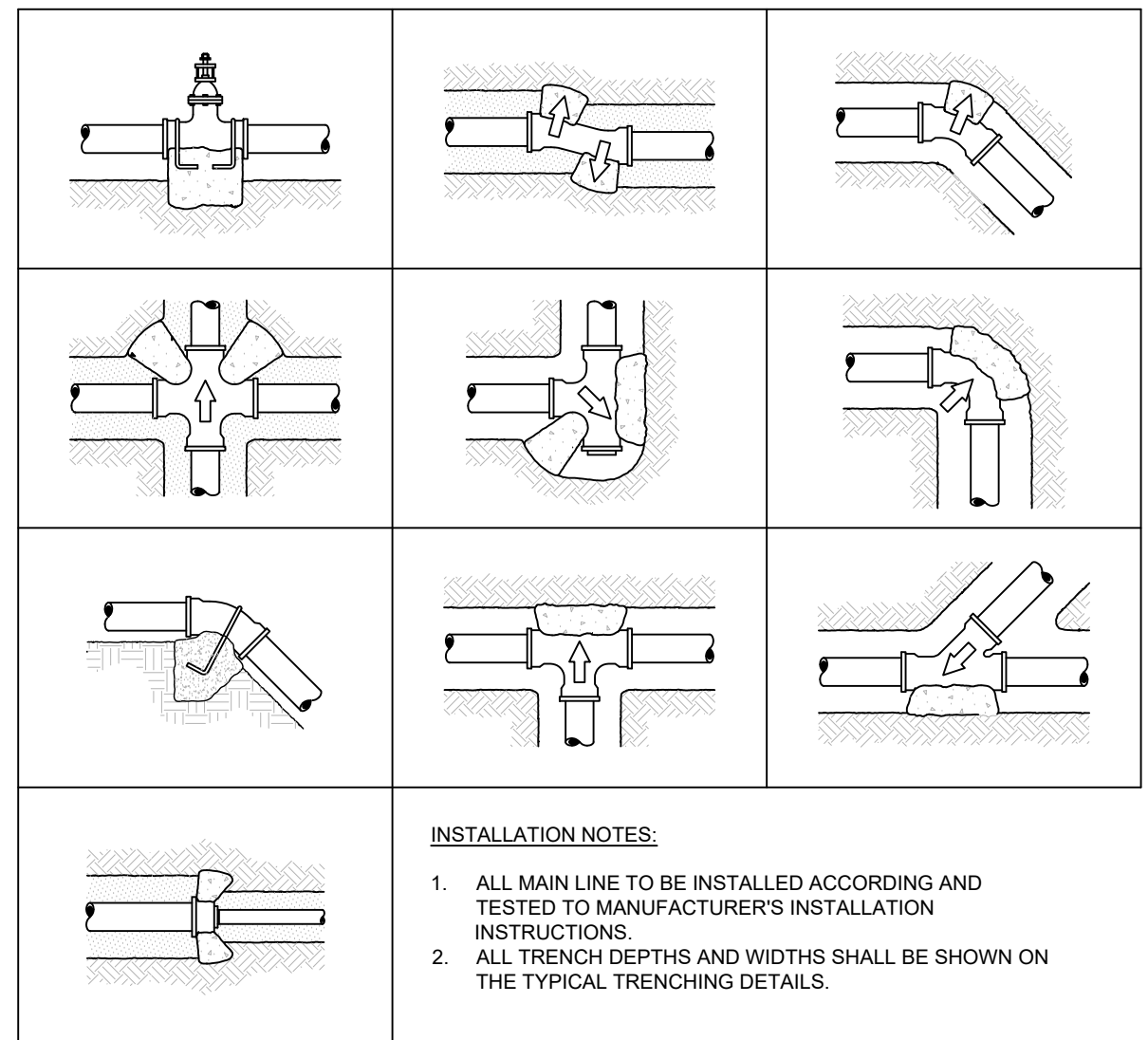

**3** TYPICAL THRUST BLOCK  
SECTION

**GENERAL IRRIGATION SPECIFICATIONS AND NOTES**

- THE SYSTEM SHALL BE DESIGNED TO PROVIDE 100% COVERAGE. ANY CHANGES MADE IN THE LAYOUT DUE TO FIELD CONDITIONS SHALL BE IN ACCORDANCE WITH THESE STANDARDS. CONTRACTOR SHALL NOTIFY LANDSCAPE ARCHITECT OF ANY DISCREPANCIES IN PLANS OR SPECIFICATIONS PRIOR TO BEGINNING OR CONTINUING WORK. THIS PLAN IS SCHEMATIC AND DUE TO THE NATURE OF CONSTRUCTION SLIGHT FIELD MODIFICATIONS MAY BE NECESSARY TO IMPLEMENT PLAN.
- THE CONTRACTOR SHALL MAKE NO SUBSTITUTIONS, DELETIONS, OR ADDITIONS TO THIS PLAN WITHOUT APPROVAL OF THE LANDSCAPE ARCHITECT.
- ALL CONSTRUCTION SHALL CONFORM TO TOWN, COUNTY, STATE, AND FEDERAL REQUIREMENTS. IT SHALL BE THE RESPONSIBILITY OF THE IRRIGATION CONTRACTOR TO ENSURE THAT ALL IRRIGATION EQUIPMENT MEETS GOVERNMENT REGULATIONS. CONTRACTOR SHALL ALSO BE RESPONSIBLE FOR OBTAINING ANY NECESSARY PERMITS OR APPROVALS.
- VERIFY LOCATIONS OF ALL UNDERGROUND UTILITIES PRIOR TO INSTALLATION OF IRRIGATION SYSTEM. ALL UTILITIES AND STRUCTURES MAY NOT BE SHOWN ON THESE PLANS-CONTRACTOR SHALL FIELD VERIFY.
- CONTRACTOR TO VERIFY ACTUAL AVAILABLE WATER PRESSURE BEFORE BEGINNING INSTALLATION. CONTRACTOR SHALL NOTIFY LANDSCAPE ARCHITECT IF AVAILABLE WATER PRESSURE EXCEEDS 5 PSI HIGHER OR LOWER THAN AVAILABLE WATER PRESSURE. REFER TO CRITICAL ANALYSIS FOR ASSUMED STATIC PRESSURE.
- CONTRACTOR TO FIELD VERIFY ALL POINT OF CONNECTION SOURCE INFORMATION INCLUDING PSI AND GPM PRIOR TO CONSTRUCTION.
- IRRIGATION DESIGN IS SCHEMATIC ONLY. FULL AND COMPLETE SHOP DRAWINGS SHALL BE SUBMITTED FOR REVIEW BY THE OWNER'S REPRESENTATIVE.
- CONTRACTOR SHALL COORDINATE WITH THE PLANTING PLAN FOR PLANTER BED AND TREE LOCATIONS TO ENSURE ALL PLANT MATERIAL IS COVERED BY 100% HEAD-TO-HEAD IRRIGATION.
- CONTRACTOR SHALL PROVIDE "AS-BUILT" DRAWINGS OF THE FINAL INSTALLATION TO OWNER AT SUBSTANTIAL COMPLETION BEFORE RECEIVING FINAL PAYMENT.
- IRRIGATION CONTRACTOR TO COORDINATE POWER SUPPLY TO ELECTRIC CONTROLLERS WITH ELECTRICAL CONTRACTOR.
- IRRIGATION CONTRACTOR SHALL SECURE ANY AND ALL NECESSARY PERMITS FOR THE WORK PRIOR TO COMMENCEMENT OF HIS OPERATIONS ON-SITE. COPIES OF THE PERMITS SHALL BE SENT TO THE OWNER/GENERAL CONTRACTOR. WORK IN THE P.O.W. SHALL CONFORM TO THE STANDARDS AND SPECIFICATIONS OF LOCAL AND/OR STATE JURISDICTION.
- IRRIGATION LATERAL LINES, MAIN LINES AND EQUIPMENT MAY BE SHOWN OUTSIDE PROPERTY LINES ON THIS PLAN. ALL IRRIGATION LINES AND EQUIPMENT ARE TO BE WITHIN AND INSTALLED WITHIN THE LIMITS OF THE PROPERTY LINE.
- LOCATE ALL IRRIGATION LINES WITHIN LANDSCAPED AREAS WHENEVER POSSIBLE. ALL LINES UNDER PAVEMENT MUST BE SLEEVED. ALL VALVES SHALL BE LOCATED WITHIN LANDSCAPED AREAS, AS SPECIFIED.
- IRRIGATION SYSTEMS CONNECTED TO POTABLE WATER SUPPLY, SHALL HAVE A BACKFLOW PREVENTER INSTALLED.
- SUPPLY LINE AND METER TO BE PROVIDED BY GENERAL CONTRACTOR. BACKFLOW PREVENTER TO BE PROVIDED BY IRRIGATION CONTRACTOR. IRRIGATION CONTRACTOR'S POINT OF CONNECTION TO BEGIN AFTER THE IRRIGATION WATER METER.
- INSTALL ALL BACKFLOW PREVENTION DEVICES AND ALL PIPING BETWEEN THE POINT OF CONNECTION AND THE BACKFLOW PREVENTER AS PER LOCAL CODES. FINAL LOCATION SHALL BE DETERMINED BY THE OWNER'S AUTHORIZED REPRESENTATIVE.
- CONTRACTOR TO COORDINATE LOCATION OF ALL METERS AND BACKFLOW ASSEMBLIES WITH PROJECT OWNER.
- THE IRRIGATION CONTRACTOR SHALL BE DIRECTLY RESPONSIBLE FOR SLEEVEING AND DIRECTIONAL BORES.
- EXISTING TREES TO REMAIN ARE TO BE PROTECTED FROM DAMAGE. DO NOT TRENCH OR EXCAVATE WITHIN THE CRITICAL ROOT ZONE OF ANY TREE.
- ALL SLEEVES UTILIZED BY THE IRRIGATION CONTRACTOR WHETHER INSTALLED BY HIM OR NOT, SHALL BE LOCATED ON THE "AS-BUILT" DRAWINGS. THE DEPTH BELOW FINISH GRADE, TO THE NEAREST FOOT OF EACH END OF THE SLEEVE SHALL BE NOTED AT EACH SLEEVE LOCATION ON THE "AS-BUILT" DRAWINGS. ALL SLEEVES ON PLAN FOR WALL PENETRATIONS AND UNDER SIDEWALKS SHALL BE SIZED TWO PIPE SIZES GREATER THAN THE PIPE IT CARRIES. ALL IRRIGATION SLEEVING TO BE THE RESPONSIBILITY OF THE IRRIGATION CONTRACTOR. ELECTRICAL WIRES FOR IRRIGATION VALVES AND IRRIGATION LINES ARE TO BE PLACED IN SEPARATE SLEEVES. SEE SLEEVEING DETAIL.
- ALL PRESSURIZED MAINLINES AND LATERALS UNDER PAVEMENT SHALL BE WITHIN SLEEVES AS NOTED. WHERE ELECTRIC OR HYDRAULIC VALVE CONTROL LINES PASS THROUGH A SLEEVE WITH OTHER MAIN OR LATERAL LINES THEY SHALL BE CONTAINED WITHIN A SEPARATE, SMALLER CONDUIT.
- SLEEVES UNDER EXISTING PAVEMENT MUST BE DIRECTIONAL BORE. OPEN CUT IS NOT AN OPTION.
- NUMBER THE TOP OF ALL VALVE BOX LIDS WITH MINIMUM 1" HEIGHT BLACK LETTERS TO CORRESPOND TO AUTOMATIC AND GATE VALVE DESIGNATIONS. ALL HOSE BIBB VALVE BOXES SHALL BE LABELED IN A SIMILAR MANNER WITH THE DESIGNATION "HB". LETTER OUTSIDE OF TIME CLOCK CABINETS TO CORRESPOND WITH IRRIGATION CLOCK PROGRAM DESIGNATION.
- THE IRRIGATION CONTRACTOR SHALL INSTALL A COLOR CODED METAL DETECTABLE MARKING TAPE WHICH CLEARLY NOTES: "CAUTION: IRRIGATION LINE BURIED BELOW." THE TAPE SHALL BE INSTALLED THE FULL LENGTH OF THE IRRIGATION MAINLINE.
- ALL VALVES, SPLICES WITHIN CONTROL LINES, AND QUICK COUPLERS SHALL BE LOCATED WITHIN VALVE BOXES.
- ALL UNSIZED PIPE SHALL BE 3/4" UNLESS OTHERWISE NOTED ON PLAN. SEE LATERAL PIPE SIZING REQUIREMENTS.
- LOCATE ALL VALVES IN PLANTING BEDS WITH A MINIMUM OF 3'-0" FROM BACK OF CURB OR EDGE OF PAVEMENT. UNLESS OTHERWISE NOTED, PIPE SIZES ON EITHER SIDE OF SECTION VALVES CONNECTING MAINLINE TO SECTION LATERAL SHALL BE ONE (1) PIPE SIZE LARGER THAN VALVE SIZE. WHERE MAINLINES RUN PARALLEL TO PAVEMENT OR CURBING, THE MAINLINE SHALL BE OFFSET 2'-0" FROM THE EDGE OF PAVEMENT OR CURB.
- IRRIGATION ZONES SHALL BE SEPARATED FOR HIGH AND LOW WATER USE REQUIREMENTS AND OPERATED ON DIFFERENT WATERING CYCLES. BUBBLERS, DRIPLINE, AND SPRAY HEADS SHALL BE SEPARATED ON DIFFERENT VALVES. AT NO TIME SHALL MULTIPLE IRRIGATION HEAD TYPES BE LOCATED ON THE SAME VALVE.
- ALL DRIP ZONES SHALL BE INSTALLED WITH A FLUSH VALVE AND DRIP INDICATOR.
- IRRIGATION CONTRACTOR TO COORDINATE WITH OWNER FOR FINAL CONTROLLER AND RAIN SENSOR LOCATIONS. THE CONTROLLER SHALL BE PLACED IN A LOCKING CABINET APPROPRIATE FOR ITS LOCATION (INDOOR VS. OUTDOOR USE).
- IRRIGATION CONTRACTOR SHALL REVIEW WINTERIZATION PROCEDURES FOR IRRIGATION SYSTEM WITH OWNERS REPRESENTATIVE.
- LOCATE THE AUTOMATIC RAIN / FREEZE SENSOR SHUTOFF DEVICE IN AN AREA THAT IS UNOBTURSCURED BY TREES, ROOF OVERHANGS, OR ANY OTHER OVERHEAD OBJECT. THE SENSOR SHALL NOT BE PLACED WITHIN THE SPRAY ZONE OF ANY SPRINKLER HEAD, INCLUDING OFF-SITE IRRIGATION. CONTRACTOR SHALL LOCATE SENSOR WITHIN CLOSE PROXIMITY TO THE IRRIGATION CONTROLLER.
- CONTRACTOR SHALL PERFORM HYDRO-TESTING OF MAIN LINES.  
HYDRO-TESTING TO BE PERFORMED AS LISTED:  
THE CONTRACTOR SHALL NOTIFY THE OWNER'S REPRESENTATIVE FORTY-EIGHT (48) HOURS IN ADVANCE OF TESTING. PRIOR TO BACKFILLING, CONTRACTOR SHALL FILL PIPING WITH WATER, IN THE PRESENCE OF THE OWNER'S REPRESENTATIVE, TAKING CARE TO PURGE THE AIR FROM IT. A SMALL, HIGH PRESSURE PUMP OR OTHER MEANS OF MAINTAINING A CONTINUOUS WATER SUPPLY SHALL BE CONNECTED TO THE PIPING AND SET SO AS TO MAINTAIN 125 PSI FOR TWO (2) HOURS WITHOUT INTERRUPTION. CONTRACTOR SHALL MAKE ANY NECESSARY CORRECTIONS AND RETEST THE SYSTEM UNTIL THE OWNER'S REPRESENTATIVE IS SATISFIED THAT THE SYSTEM IS REASONABLY SOUND.
- ALL WIRING FOR CONNECTION OF THE VALVES TO THE CONTROLLER SHALL FOLLOW MANUFACTURERS' SPECIFICATIONS.
- ALL CONTROL WIRE SHALL BE INSTALLED IN A 1 1/2" ELECTRICAL CONDUIT.
- CONTRACTOR TO MINIMIZE IRRIGATION OVERTHROW TO IMPERVIOUS AND NATURAL AREAS THROUGH FIELD ADJUSTMENTS TO INDIVIDUAL HEADS.
- ALL UNIMPROVED AREAS DISTURBED DURING CONSTRUCTION SHALL BE RESTORED TO THEIR ORIGINAL CONDITION BY THE CONTRACTOR.
- ALL PLANT MATERIAL IN TREE HOLDING AREAS SHALL BE MANUALLY WATERED/IRRIGATED TO KEEP MOIST UNTIL PLANTED.

8 RAIN BIRD PEB (2)  
Common Wire 1-1/2" TUI

THE CITY OF COLORADO SPRINGS HAS ADOPTED PERMANENT WATER-WISE REGULATIONS AT THE START OF 2020 WHICH WILL AFFECT THE OVERALL OPERATION OF THE IRRIGATION SYSTEM.

- WATERING IS LIMITED TO THREE DAYS A WEEK (DRIP IRRIGATION IS ALLOWED AT ANY TIME)
- ESTABLISHMENT PERMITS ARE REQUIRED FROM COLORADO SPRINGS UTILITIES FOR CUSTOMERS WHO NEED TO TEMPORARILY WATER MORE THAN THREE DAYS A WEEK TO ESTABLISH NEW LANDSCAPES.
- FROM MAY 1 TO OCTOBER 15, SPRINKLERS CAN BE OPERATED BEFORE 10 A.M. AND AFTER 6 P.M. SPRINKLERS CAN BE OPERATED AT ANY TIME OF DAY BEFORE MAY 1 AND AFTER OCTOBER 15.
- ALLOCATION PLANS ARE AVAILABLE FOR CUSTOMERS WHO NEED MORE WATERING SCHEDULE FLEXIBILITY FROM COLORADO SPRINGS UTILITIES.

NOTE: THE WATERING SCHEDULE PROVIDED IS CONCEPTUAL. IT IS DISPLAYED TO SHOW COMPLIANCE WITH THE CITY OF COLORADO SPRINGS WATER-WISE ORDINANCE. CONTRACTOR SHALL VERIFY AND SET A COMPLIANT WATERING SCHEDULE WITH THE PROPERTY OWNER AND/OR THEIR ASSIGNED.

**D49 TRANSPORTATION CENTER**  
**SCHOOL DISTRICT NO 49**  
 11971 SWINGLINE ROAD  
 PEYTON, CO 80831

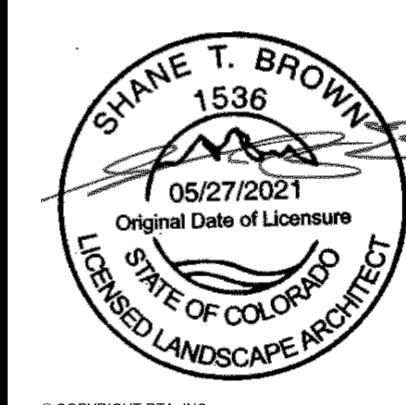

© COPYRIGHT 2022, INC.

SHEET TITLE  
**Irrigation Details**

RTA PROJECT NUMBER  
**2021-041.00**  
DATE  
**05/23/2022**  
REVISIONS

#	DATE	DESCRIPTION
1	06/09/2022	ASB 01

DATE APPROVAL: JH  
DRAWN BY: AK  
CHECKED BY: SB

ISSUES FOR  
CONSTRUCTION DOCUMENTS

SHEET NO.  
**IR-103**