

Please see and address all comments listed in the FDR V1 for PPR2256 SDP submittal and email sent on 8 DEC 2022 addressing questions. The same FDR should be submitted for both the Plat and Site Dev Plan

**Final Drainage Report
U-Haul at Falcon
Falcon U-Haul Filing 1
El Paso County, Colorado**

Please add PCD File #s
SF-22-40
PPR-22-56

Prepared for:
Amerco Real Estate Company
2727 N Central Avenue
Phoenix, AZ 85004

Prepared by:

Kiowa
Engineering Corporation

7175 West Jefferson Avenue, Suite 2200
Lakewood, Colorado 80235
Ph: (303)692-0369

Kiowa Project No. 21061

September 6, 2022

TABLE OF CONTENTS

Table of Contents i

Statements and Approvals ii

I. General Location and Description..... 1

II. Major Drainage Basins and Subbasins 1

III. Existing Drainage Patterns..... 2

IV. Drainage Design Criteria..... 3

V. Drainage Facility Design 3

A. Proposed Drainage Patterns 4

B. Stormwater Quality Design..... 6

C. Cost of Proposed Drainage Facilities 6

D. Drainage and Bridge Fees 6

VI. Conclusions 6

VII. References..... 7

Appendix Table of Contents..... 8

STATEMENTS AND APPROVALS

ENGINEER'S STATEMENT:

The attached drainage plan and report were prepared under my direction and supervision and are correct to the best of my knowledge and belief. Said drainage report has been prepared according to the criteria established by the City/County for drainage reports and said report is in conformity with the master plan of the drainage basin. I accept responsibility for any liability caused by any negligent acts, errors or omissions on my part in preparing this report.

Kiowa Engineering Corporation, 7175 West Jefferson Ave, Suite 2200, Lakewood, CO 80235

Matthew W. Erichsen, P.E. (PE #36713)
For and on Behalf of Kiowa Engineering Corporation

Date

DEVELOPER'S STATEMENT:

I, the Developer, have read and will comply with all of the requirements specified in this drainage report and plan.

By: _____
Amerco Real Estate Company

Date

Print Name: _____

Address: Amerco Real Estate Company
2727 North Central Ave
Phoenix, AZ 85004

EL PASO COUNTY:

Filed in accordance with the requirements of the Drainage Criteria Manual, Volumes 1 & 2, El Paso County Engineering Criteria Manual, and Land Development Code, as amended.

~~Interim~~ El Paso County Engineer/ECM Administrator

Date

I. GENERAL LOCATION AND DESCRIPTION

The Falcon U-Haul Filing No. 1 property will be developed as a commercial development including two main buildings on the site for self storage, U-Box warehouse, showroom, vehicle sharing and retail area. The subject property is located along the south side of Rolling Thunder Way, west of Meridian Road and north of Tamlin Road in Falcon, Colorado. The site is located in the east half of Section 12, Township 13 South, Range 65 West of the 6th Principal Meridian, in El Paso County, Colorado. The site is bounded to the west by Falcon Highlands Filing No. 2, future Falcon Highlands Filing No. 3, to the south by Tamlin Road, east by Meridian Road and north by Rolling Thunder Way. The Unnamed West Tributary to Black Squirrel Creek No. 2 (West Tributary) is a drainageway along the west side of the property which includes a regulated FEMA Zone AE floodplain. The drainageway and floodplain is located outside the subject property. The property covers approximately 11.50 acres and is currently undeveloped. The property is planned to be developed in two phases. The northern portion which is described in this drainage report and the southern portion will be developed in the future. The southern portion is planned to be developed as mini self storage and RV storage. A vicinity map of the site is shown on Figure 1 included in the Appendix.

The existing vegetative cover within the development is in fair condition with grasses throughout the site. The existing ground slopes within the property range from 1 to 6 percent typical with areas of vertical slopes along the edges. Soils within the subject site are classified to be within Hydrologic Soil Group A as shown in the El Paso County Soils Survey, see Appendix for the Soil Map. Specifically the site includes Blakeland Fluvaquentic Haplaquolls soil. For the purposes of computing the existing and proposed hydrology for the site, Hydrologic Soil Group AB was used.

There are no active irrigation ditches or facilities within or adjacent to the site.

II. MAJOR DRAINAGE BASINS AND SUBBASINS

The site lies within the Falcon drainage basin. The majority of the site drains by sheet flow southwest into the West Tributary near the south end of the property before flowing into Detention Pond WU. The property has been included in multiple drainage studies. The *Falcon Drainage Basin Planning Study (DBPS) (2015)* shows overall Falcon drainage basin and the West Tributary. The U-Haul site is located in Drainage Basin WT240 and the portion of the West Tributary adjacent to the site Element RWT240. The *DBPS* includes the stormwater detention values for Regional Pond WU and identifies improvements to the Pond.

The Bent Grass Development FDR, MDDP & DBPS Amendment provides the design of the improvements including water quality facilities. For the West Tributary, the *DBPS* indicates “Protect in Place” which is described as “There are several relatively pristine reaches of channel throughout the Falcon Watershed that are currently in a stable condition. Additionally, there are several reaches throughout the Falcon Watershed that have already been improved and appear to be stable. Preserving both of these reach conditions would not require a direct reach improvement cost. However, upstream detention improvements may be required depending on the location of the reach.”. The *DBPS* does not identify any improvements to the West Tributary or include any improvements costs for it.

The Bent Grass Development includes an FDR and MDDP & DBPS Amendment (2021). The reports and associated construction plans show improvements to Detention Pond WU including water quality improvements. Those improvements have been completed. The design accounted for the future development of the U-Haul site as a commercial development.

The Falcon Highlands Market Place Filing No. 1 Preliminary and Final Drainage Report (2005) studied the area directly north of Pond WU including the U-Haul site. This study includes the runoff

calculations for the area upstream tributary to the existing 42-inch storm sewer crossing under Rolling Thunder Way at the northeast corner of the property. The report describes the existing drainage channel downstream of the 42-inch pipe and the expectation the channel will be replaced with a pipe with the development of the subject property to convey the flows through the site to the West Tributary and Pond WU. The report identifies this public/private storm sewer system however it is not included in the DBPS and the DBPS schedule of improvement costs. This should be a reimbursable cost and as such a cost estimate is provided in the Appendix. Refer to the Drainage and Bridge Fees section. This report assumed a fully developed property for the subject site with runoff coefficients of $C_5=0.90$ and $C_{100}=0.95$.

The subject property is not located within a FEMA regulated floodplain. The West Tributary is located adjacent to the site and does include a Zone AE FEMA regulated floodplain based on Flood Insurance Rate Map 08041C0561G, effective dated December 7, 2018. A copy of the FIRM panel is provided in the Appendix.

III. EXISTING DRAINAGE PATTERNS

The existing drainage patterns for the property include mainly sheet flow to the south where the flows will drain into the West Tributary which is connected to Regional Detention Pond WU. Following is a description of the existing drainage patterns, refer to the Drainage Plan – Existing Conditions for the basin locations and the Appendix for the runoff calculations.

Design Point 23: This Design Point is from the Falcon Highlands Market Place Filing No. 1 PDR and FDR. The DP includes the flows being conveyed through the existing 42-inch storm sewer under Rolling Thunder Way at the northeast corner of the property. The flow assumes a fully developed tributary area upstream of the DP including both the streets and properties.

Basin OS-1: The drainage basin is located along Rolling Thunder Way street section to the north of the site. The basin includes mainly paved area with the sidewalk and tree lawn. The runoff from the basin sheet flows to the south street curb line and drains into Basin EX-B in the subject site through the north driveway access.

Basin EX-A: The drainage basin is located at the northwest corner of the property. The runoff from the basin sheet flows southwest to the property line where it will continue west into the West Tributary.

Basin EX-B: The drainage basin includes most of the property. The runoff sheet flows south into the existing drainage swale downstream of the existing 42-inch storm sewer. The swale conveys the flows south off the property at future Tamlin Road where the flows continue into the West Tributary and then Pond WU. The existing 42-inch storm sewer described in DP 23 drains into this basin and is conveyed by the existing drainage swale.

Basin EX-C: The drainage basin is located at the northeast corner of the property. The runoff from the basin sheet flows east onto Meridian Road gutter where the flows will continue south to Tamlin Road.

Regional Detention Pond WU: Pond WU is located south of the site and is an in-line regional detention basin with stormwater quality facilities. The current design of the Pond and facilities is described in the Bent Grass MDDP/DBPS Amendment. The detention basin is designed to have an embankment on the upstream end across the West Tributary at future Tamlin Road. The embankment includes an 18-inch culvert at the upstream low point to capture and convey the minor flows from the West Tributary. Larger storm events will pond upstream of the embankment until reaching the spillway crest elevation at a depth of roughly 8.4-ft. The flows will then overtop the embankment and drain into Pond WU. To the east of this embankment are twin 18-inch storm sewer pipes which have an

invert roughly 1.0-ft below the spillway crest. These pipes drain to a side “diversion” channel and it appears these flows are meant to provide moisture for the vegetation in this side channel. The DBPS indicates the future/proposed Tamlin Road crossing of the West Tributary will replace the existing 18-inch storm sewer with a 12’(W) x 6’(H) box culvert and removal of the existing embankment. Pond WU does not currently include a concrete trickle channel to convey flows. Based on the Falcon Highlands Filing No. 3 PDR, a concrete trickle channel will be constructed as part of that development. This development will not include any improvements to Pond WU.

IV. DRAINAGE DESIGN CRITERIA

Hydrologic and hydraulic calculations for the site were performed using the methods outlined in the *El Paso County Drainage Criteria Manual*. Topography for the site is presented on the Drainage Plan. The hydrologic calculations were made for the existing and proposed site conditions. The Drainage Plan presents the drainage patterns for the site, including the drainage basins. The peak flow rates for the drainage basins were estimated using the Rational Method. The 5-year (Minor Storm) and 100-year (Major Storm) recurrence intervals were determined. The one-hour rainfall depth was determined from Table 6-2 of the *Drainage Criteria Manual*. The peak flow data generated using the rational method was used to size inlets and storm sewers within the site. The drainage basin area, time of concentration, and rainfall intensity were determined for each of the drainage basins within the property. The onsite soils were assumed to be Hydrologic Soil Group AB, based on the *Soil Survey*.

The onsite hydraulic structures were sized using the methods outlined in the *El Paso County Drainage Criteria Manual*. The hydraulic capacities of the curb inlets were determined using the MHFD-Inlet spreadsheet developed by the MHFD. Colorado Department of Transportation (CDOT) Type R curb inlets, Type 13 valley inlets and Type C grated inlets will be used within the site. Storm sewer pipes were initially sized based on their full-flow capacity using the Manning’s equation. The UDSewer program was then used to verify storm sewer pipe sizes and perform hydraulic grade line (HGL) and energy grade line (EGL) calculations for the 5-year and 100-year storm events. Hydraulic calculations are provided in the Appendix for the proposed inlet and pipe capacities.

The subject site is tributary to Regional Detention Pond WU which is located directly downstream of the site along Unnamed West Tributary to Black Squirrel Creek No. 2. Stormwater quality and detention for the property is provided in Detention Pond WU, so no on site water quality or detention improvements will be required.

V. DRAINAGE FACILITY DESIGN

The drainage of the site will be accomplished through a combination of sheet flow, gutter flow and storm sewer flow. The site has been graded to convey runoff to low points on the site where drainage inlets, curb openings or pipes are located to capture the 100 year flow and direct it into a storm sewer which will discharge to the West Tributary upstream of Detention Pond WU. The proposed drainage patterns for the site are shown on the Drainage Plan – Proposed Conditions (Exhibit B) provided in the map pocket at the end of this report. The hydrologic and hydraulic calculations are provided in the Appendix.

The on-site drainage system will include a couple storm sewer systems. The main system will be Storm Sewer System A (Storm A) which is located along the east side of the site conveying flows from discharged into the northeast corner of the site by an existing 42-inch RCP storm sewer. Storm A will also be used to convey on site runoff through the site and into Pond WU. A forebay with energy dissipator will constructed on the end of Storm A for energy dissipation, water quality and erosion protection. Tributary A is considered Waters of the State, for that reason Storm A has been extended past Tributary A to outfall directly to Pond WU. If Storm A connected to Tributary A, then the County

requires water quality to be provided for the storm water runoff being discharging to Waters of the State, in this case Tributary A. Pond WU was designed to provide stormwater quality for the area tributary to Storm Sewer A.

The County requires a Four Step Process for selection of appropriate permanent BMPs for the site. In this development following are the steps taken to meet this process.

Step 1-Employ Runoff Reduction Practices: Runoff from a portion of the site along the west side will be routed through a grass lined swale before reaching the drainage inlets. The middle and east portions of the site have less opportunity to use Minimizing Directly Connected Impervious Areas (MDCIA) due to required vehicle turning movements and layout of the facilities. The site ultimately drains to Regional Detention Pond WU which includes a pervious bottom for stormwater infiltration and runoff reduction.

Step 2-Stabilize Drainageways: The West Tributary is located adjacent to the site to the west. The West Tributary was analyzed as part of the *DBPS* and the selected plan is to “Protect in Place” which is described as “There are several relatively pristine reaches of channel throughout the Falcon Watershed that are currently in a stable condition. Additionally, there are several reaches throughout the Falcon Watershed that have already been improved and appear to be stable. Preserving both of these reach conditions would not require a direct reach improvement cost. However, upstream detention improvements may be required depending on the location of the reach.”. The *DBPS* does not identify any improvements to the West Tributary or include any improvements costs for it. The proposed development does not discharge developed flows into Tributary A until Pond WU which is stabilized.

Step 3-Provide Water Quality Capture Volume (WQCV): Regional Detention Pond WU is located downstream of the site and will provide the WQCV as shown in the Bent Grass Development MDDP & *DBPS* Amendment and the Falcon Highlands Market Place Filing No. 1 PDR/FDR.

Step 4-Consider Need for Industrial and Commercial BMPs: The potential pollutant sources for a commercial development like this one include: parked vehicles, deicing chemicals/snow storage, waste storage/disposal practices and landscapes (fertilizers, herbicides, pesticides, excessive irrigation). Some of the planned source control BMPs for the development include the following: No vehicle maintenance is allowed on the site. The property owner provides trash collection and full landscape maintenance for the development. The application of fertilizers, pesticides and other chemicals is planned to be done per manufacturer’s recommendations. The owner will ensure proper use, storage and disposal of materials on site. Material and equipment necessary for spill cleanup will be kept on the site.

A. PROPOSED DRAINAGE PATTERNS

Following is a description of the proposed condition drainage basins and the main storm sewer system which conveys flows through the site (Storm Sewer System A or Storm A).

Drainage Basin A: The basin is located along the northwest corner of the property. It includes pavement and landscape areas. The runoff from the basin will sheet flow southwest to the curb line or drain pan which will direct the flows to a curb opening in sump condition at the southwest corner of the paved lot. The flows will continue into Basin D in a grass lined swale.

Drainage Basin B: The basin is located in the north central portion of the site. It includes mainly pavement areas. The runoff from Basin OS-1 will enter this basin at the north end. The runoff from the basin will sheet flow south to a low point in the paved area between the buildings where a grated valley inlet in sump condition with 100-year capacity will be

located. A pipe will extend out of the inlet south and be routed to Storm A which drains to the West Tributary.

Drainage Basin C: The basin is located in the northeast portion of the site. It includes pavement and landscape areas. The runoff from the basin will sheet flow to the proposed drain pan or curb line which will convey the flows to a low point and curb opening at the northeast corner of the paved area. A storm sewer flared end section will be located behind the curb opening to capture the 100-year flows and convey to Storm A.

Drainage Basin D: The basin is located to the west of Building B. It includes landscape area. The runoff from the basin will sheet flow to a swale which will drain the flows to a proposed Type C Inlet in sump condition with 100-year capacity. A pipe will convey the flows from the inlet to the West Tributary. A low tailwater riprap basin will be located at the end of the pipe to dissipate the flows and minimize erosion in the channel.

Drainage Basin E: The basin is located on the west side of the site and includes the roof of Building B. The runoff from the roof will drain to the west side where a gutter and downspouts will convey the flows down to the ground surface and into Basin D.

Drainage Basin F.1: The basin is located on the east side of the site and includes the north portion of the Building A roof. The runoff from the roof will drain to the east side where a gutter and downspouts will convey the flows down to the paved ground surface and into Basin C.

Drainage Basin F.2: The basin is located on the east side of the site and includes the north portion of the Building A roof. The runoff from the roof will drain to the east side where a gutter and downspouts will convey the flows down to the paved ground surface and into Basin G.

Drainage Basin G: The basin is located to the east of Building A. It includes paved and landscaped areas. The runoff from the basin will sheet flow to the gutter line which will convey the flows to a low point where a curb inlet will be located in sump condition with 100-year capacity. A pipe will convey the flows from the inlet to Storm A.

Drainage Basin H: The basin is located on the west side of the site and includes the Building A loading dock ramp. The runoff from the ramp will drain to a trench drain in sump condition and 100 year capacity. A storm sewer pipe will extend from the trench drain to the storm sewer from Basin B

Drainage Basin I: The basin is located to the south of Building A. It includes paved and landscaped areas. The runoff from the basin will sheet flow to the gutter line which will convey the flows to a low point where a curb inlet will be located in sump condition with 100-year capacity. A pipe will convey the flows from the inlet to Storm A. In the future the area to the south will be developed.

Drainage Basin K: The basin is located in the southwest portion of the site. It currently includes grassed areas and a paved access drive. The runoff from the basin will sheet flow to the south end of the site where a low point is located with a “temporary” storm sewer pipe to capture the flows and convey to Storm A. In the future, the area within the basin will be developed. Drainage Basin K-Dev assumes a developed percent impervious. The runoff from the developed basin will also connect to Storm A.

Drainage Basin L: The basin is located in the southeast portion of the site. It currently includes grassed areas. The runoff from the basin will sheet flow to the east of the access drive and south end of the site where a low point is located with a “temporary” storm sewer pipe

to capture the flows and convey to Storm A. In the future, the area within the basin will be developed. Drainage Basin L-Dev assumes a developed percent impervious. The runoff from the developed basin will also connect to Storm A.

Storm Sewer System A (Storm A): The storm sewer system is located along the east side of the development. Storm A will connect to the existing 42-inch storm sewer which conveys off site flows onto the site from under Rolling Thunder Way at the northeast corner of the property. The on-site storm sewer will connect to Storm A which is designed to convey the 100-year storm through the site to Pond WU. Refer to previous discussion regarding Waters of the State and the West Tributary. A forebay will be located at the end of the storm sewer pipe to dissipate the flows, minimize erosion and provide pre-sedimentation for water quality.

B. STORMWATER QUALITY DESIGN

Storm water quality improvements for the site will be provided in the existing Detention Pond WU. The WQCV is provided in Pond WU and it accounted for the proposed development of the subject site. The original design of Pond WU was completed as part of the Falcon Highlands Filing No. 2 MDDP/PDR/FDR. Water quality improvements were made to Pond WU as part of Bent Grass Development MDDP & DBPS Amendment, FDR and Construction Plans.

C. COST OF PROPOSED DRAINAGE FACILITIES

Table 2 presents a cost estimate for the construction of drainage improvements (public and private) for development. The subject development requires the construction of a 42-inch storm sewer through the property to convey off site public and private flows to the West Tributary and Pond WU. The cost associated with this storm sewer extension is not included in the DBPS as a reimbursable cost, however as part of this report, it is requested the cost for these improvements be reimbursed. The costs for this storm sewer extension has been broken out separately in Table 2.1.

D. DRAINAGE AND BRIDGE FEES

The site lies within the Falcon Drainage Basin. The DBPS was completed in 2015. No drainage improvements were identified for the West Tributary adjacent to the site or for the storm sewer extension through the property. The 2022 drainage basin fee is \$34,117 per impervious acre and the bridge fee is \$4,687 per impervious acre. The Falcon U-Haul property encompasses 11.50 acres. Table 1 details the fees due as part of this development. Table 2 includes an opinion of cost for the storm sewer extension noted in the previous section. This amount has been added to Table 1 for the calculation of Drainage Fees. The developer will follow the procedures for drainage improvement credits and reimbursements as outlined in EPC DCM Chapter 3, Section 3.3 to determine the final reimbursement.

VI. CONCLUSIONS

The U-Haul at Falcon development will be a commercial development with two buildings and associated paved and landscaped areas on approximately 11.50 acres. The buildings and site will provide self storage, U-Box warehouse, showroom, vehicle sharing and retail area. This phase includes the development of the north side of the property. A future phase is planned to develop the south side of the property with self mini storage and RV storage. The on site drainage will be conveyed and captured by a combination of sheet flow, gutter flow, swale flow, inlets and storm sewers draining directly to Pond WU through Storm Sewer System A which includes on-site and off-

site flows. The off-site storm sewer enters the site at the northeast corner which will be extended along the east side of the site to the south end outfalling into regional Pond WU, benefitting the upstream properties and the subject site by draining directly to Pond WU instead of the West Tributary which is Waters of the State. Regional Detention Pond WU provides stormwater quality and detention for the site. No onsite stormwater quality or detention will be required. The Unnamed West Tributary to Black Squirrel Creek No. 2 (West Tributary) is located adjacent to the site on the west side and is described in the Falcon DBPS. The DBPS does not identify any required improvements to the West Tributary or Detention Pond WU.

VII. REFERENCES

- 1) Falcon Highlands Market Place, Filing No. 1 Preliminary and Final Drainage Report, prepared by URS, dated December 22, 2005.
- 2) Market Place Filing No. 2, Final Drainage Letter, prepared by Springs Engineering, dated November 2008.
- 3) Falcon Drainage Basin Planning Study, Selected Plan Report, prepared by Matrix Design Group, dated September 2015.
- 4) Final Drainage Report, Bent Grass Residential Subdivision Filing No. 2, prepared by Galloway, dated March 2020.
- 5) MDDP and DBPS Amendment, Bent Grass Development, prepared by Galloway, dated September 2021.
- 6) Final Grading & Erosion Control Plans, Bent Grass Residential Filing No. 2, prepared by Galloway, dated 3/4/2021.
- 7) Falcon Highlands Filing No. 3 Preliminary Drainage Report, prepared by Atwell, LLC, dated March 24, 2022.
- 8) El Paso County, Colorado, Flood Insurance Study, prepared by the Federal Emergency Management Agency, dated December 7, 2018.
- 9) El Paso County Drainage Criteria Manual (Volumes 1 and 2) and Engineering Criteria Manual, current editions.
- 10) Urban Storm Drainage Criteria Manual (USDCM) Volumes 1, 2 and 3, Mile High Flood District, Current Editions
- 11) Soil Survey of El Paso County Area, Colorado, prepared by United States Department of Agriculture Soil Conservation Service.

APPENDIX TABLE OF CONTENTS

APPENDIX A

- Figure 1: Vicinity Map
- Soils Map
- FEMA Flood Insurance Rate Map
- Table 1: Drainage Basin & Bridge Fee Calc
- Table 2: Opinion of Cost – Drainage Facilities

APPENDIX B

- Hydrologic Calculations
 - Runoff Coef, Time of Concentration and Runoff Calcs

APPENDIX B.1

- Supporting Tables and Figures

APPENDIX C

- Hydraulic Calculations
 - Inlet Summary and Capacity Calculations – UD-Inlet
 - Pipe Sizing Calculations

APPENDIX D

- Pages from Relevant Previous Studies
 - Falcon Highlands Market Place Flg No. 1 FDR
 - Market Place Flg No. 2 Final Drainage Letter
 - Bent Grass Development MDDP & DBPS Amendment
 - Falcon Drainage Basin Planning Study

APPENDIX E

- Exhibit A: Drainage Plan – Existing Conditions
- Exhibit B: Drainage Plan – Proposed Conditions

APPENDIX A

Figure 1: Vicinity Map

Soils Map

FEMA Flood Insurance Rate Map

Table 1: Drainage Basin & Bridge Fee Calc

Table 2: Opinion of Cost – Drainage Facilities

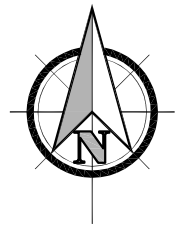

SCALE: NTS

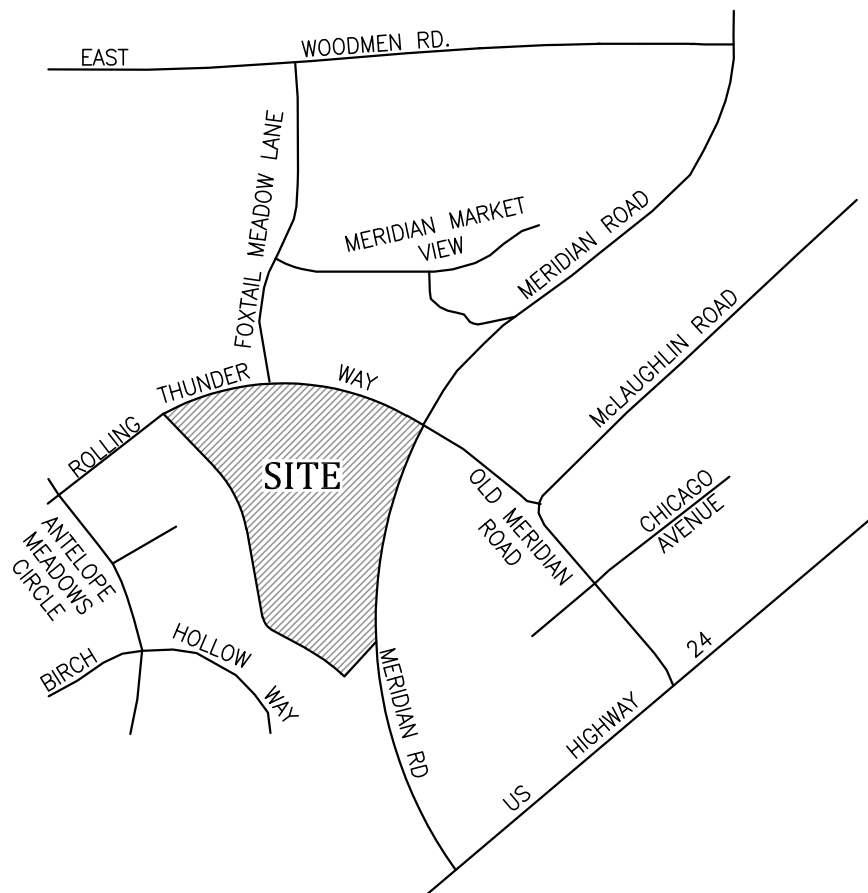
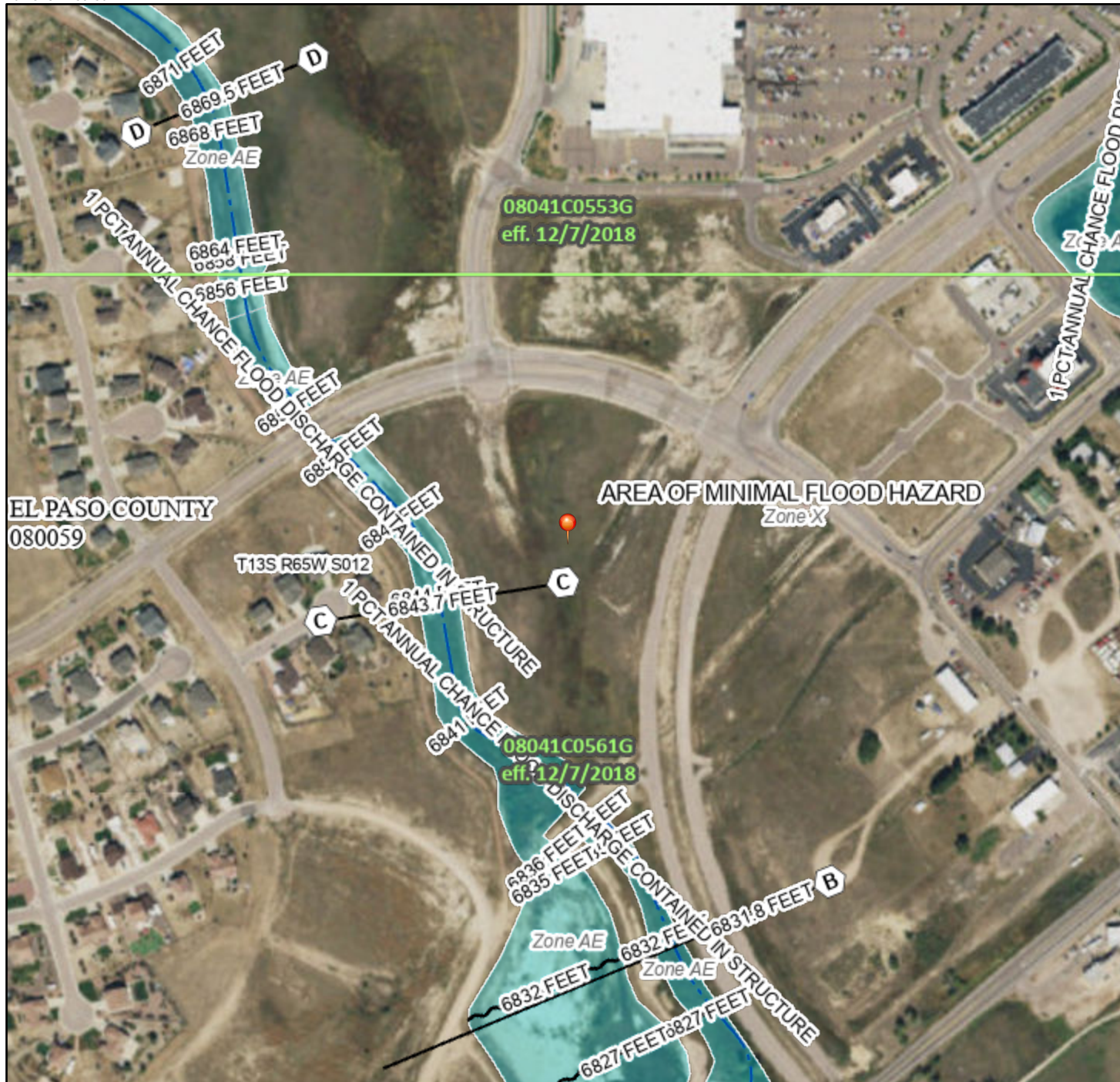

FIGURE 1
VICINITY MAP
U-HAUL FALCON

National Flood Hazard Layer FIRMMette



104°37'9"W 38°56'22"N



EL PASO COUNTY
080059

08041C0553G
eff. 12/7/2018

08041C0561G
eff. 12/7/2018

0 250 500 1,000 1,500 2,000 Feet 1:6,000 104°36'31"W 38°55'54"N

Basemap: USGS National Map: Orthoimagery: Data refreshed October, 2020

Legend

SEE FIS REPORT FOR DETAILED LEGEND AND INDEX MAP FOR FIRM PANEL LAYOUT

SPECIAL FLOOD HAZARD AREAS		Without Base Flood Elevation (BFE) Zone A, V, A99
		With BFE or Depth Zone AE, AO, AH, VE, AR
		Regulatory Floodway
OTHER AREAS OF FLOOD HAZARD		0.2% Annual Chance Flood Hazard, Areas of 1% annual chance flood with average depth less than one foot or with drainage areas of less than one square mile Zone X
		Future Conditions 1% Annual Chance Flood Hazard Zone X
		Area with Reduced Flood Risk due to Levee. See Notes. Zone X
		Area with Flood Risk due to Levee Zone D
OTHER AREAS		NO SCREEN Area of Minimal Flood Hazard Zone X
		Effective LOMRs
GENERAL STRUCTURES		Area of Undetermined Flood Hazard Zone D
		Channel, Culvert, or Storm Sewer
		Levee, Dike, or Floodwall
OTHER FEATURES		20.2 Cross Sections with 1% Annual Chance
		17.5 Water Surface Elevation
		Coastal Transect
		Base Flood Elevation Line (BFE)
		Limit of Study
		Jurisdiction Boundary
MAP PANELS		Digital Data Available
		No Digital Data Available
		Unmapped

The pin displayed on the map is an approximate point selected by the user and does not represent an authoritative property location.

This map complies with FEMA's standards for the use of digital flood maps if it is not void as described below. The basemap shown complies with FEMA's basemap accuracy standards

The flood hazard information is derived directly from the authoritative NFHL web services provided by FEMA. This map was exported on **11/30/2021 at 11:28 AM** and does not reflect changes or amendments subsequent to this date and time. The NFHL and effective information may change or become superseded by new data over time.

This map image is void if the one or more of the following map elements do not appear: basemap imagery, flood zone labels, legend, scale bar, map creation date, community identifiers, FIRM panel number, and FIRM effective date. Map images for unmapped and unmodernized areas cannot be used for regulatory purposes.

Hydrologic Soil Group—El Paso County Area, Colorado



Map Scale: 1:2,820 if printed on A portrait (8.5" x 11") sheet.



Map projection: Web Mercator Corner coordinates: WGS84 Edge tics: UTM Zone 13N WGS84



MAP LEGEND

Area of Interest (AOI)









 Area of Interest (AOI)

Soils

Soil Rating Polygons





 A
 A/D
 B
 B/D
 C
 C/D
 D
 Not rated or not available

Soil Rating Lines

 A
 A/D
 B
 B/D
 C
 C/D
 D
 Not rated or not available

Soil Rating Points





 A
 A/D
 B
 B/D

 C
 C/D
 D
 Not rated or not available

Water Features

 Streams and Canals

Transportation

 Rails
 Interstate Highways
 US Routes
 Major Roads
 Local Roads

Background

 Aerial Photography

MAP INFORMATION

The soil surveys that comprise your AOI were mapped at 1:24,000.

Warning: Soil Map may not be valid at this scale.

Enlargement of maps beyond the scale of mapping can cause misunderstanding of the detail of mapping and accuracy of soil line placement. The maps do not show the small areas of contrasting soils that could have been shown at a more detailed scale.

Please rely on the bar scale on each map sheet for map measurements.

Source of Map: Natural Resources Conservation Service
 Web Soil Survey URL:
 Coordinate System: Web Mercator (EPSG:3857)

Maps from the Web Soil Survey are based on the Web Mercator projection, which preserves direction and shape but distorts distance and area. A projection that preserves area, such as the Albers equal-area conic projection, should be used if more accurate calculations of distance or area are required.

This product is generated from the USDA-NRCS certified data as of the version date(s) listed below.

Soil Survey Area: El Paso County Area, Colorado
 Survey Area Data: Version 19, Aug 31, 2021

Soil map units are labeled (as space allows) for map scales 1:50,000 or larger.

Date(s) aerial images were photographed: Sep 11, 2018—Oct 20, 2018

The orthophoto or other base map on which the soil lines were compiled and digitized probably differs from the background imagery displayed on these maps. As a result, some minor shifting of map unit boundaries may be evident.

Hydrologic Soil Group

Map unit symbol	Map unit name	Rating	Acres in AOI	Percent of AOI
9	Blakeland-Fluvaquentic Haplaquolls	A	21.2	97.0%
19	Columbine gravelly sandy loam, 0 to 3 percent slopes	A	0.6	3.0%
Totals for Area of Interest			21.9	100.0%

Description

Hydrologic soil groups are based on estimates of runoff potential. Soils are assigned to one of four groups according to the rate of water infiltration when the soils are not protected by vegetation, are thoroughly wet, and receive precipitation from long-duration storms.

The soils in the United States are assigned to four groups (A, B, C, and D) and three dual classes (A/D, B/D, and C/D). The groups are defined as follows:

Group A. Soils having a high infiltration rate (low runoff potential) when thoroughly wet. These consist mainly of deep, well drained to excessively drained sands or gravelly sands. These soils have a high rate of water transmission.

Group B. Soils having a moderate infiltration rate when thoroughly wet. These consist chiefly of moderately deep or deep, moderately well drained or well drained soils that have moderately fine texture to moderately coarse texture. These soils have a moderate rate of water transmission.

Group C. Soils having a slow infiltration rate when thoroughly wet. These consist chiefly of soils having a layer that impedes the downward movement of water or soils of moderately fine texture or fine texture. These soils have a slow rate of water transmission.

Group D. Soils having a very slow infiltration rate (high runoff potential) when thoroughly wet. These consist chiefly of clays that have a high shrink-swell potential, soils that have a high water table, soils that have a claypan or clay layer at or near the surface, and soils that are shallow over nearly impervious material. These soils have a very slow rate of water transmission.

If a soil is assigned to a dual hydrologic group (A/D, B/D, or C/D), the first letter is for drained areas and the second is for undrained areas. Only the soils that in their natural condition are in group D are assigned to dual classes.

U-Haul at Falcon
Drainage Basin and Bridge Fees

Please see comments in FDR V1 for PPR2256 and address needed corrections.

Table 1: Impervious Area and Drainage & Bridge Fee Calculation

U-haul at Falcon

Drainage and bridge fees require correction

Total Site/Platted Area = 11.50 ac
Effective % Impervious = 54.4 %

Falcon Drainage Basin: Drainage Fee and Bridge Fee Calculations			
			Property
Drainage Fee =	\$15,720 / ac	Drainage Fee* =	\$ 98,413
Bridge Fee =	\$4,762 / ac	Bridge Fee* =	\$ 29,812

	Drainage Fee =	\$ 98,413
Reimbursable	Storm Sewer Extension thru Property Expense =	\$ 404,717
	Drainage Fee Due** =	\$ 0
	Bridge Fee Due =	\$ 29,812

**Reimbursable Expenses applied to drainage fees due

The Reimbursable Storm Sewer Extension thru Property (42" RCP storm sewer) is not shown as reimbursable expense in the Falcon DBPS, however the storm sewer is required to convey public and private off site flows through this property and should be a reimbursable expense. The developer will follow the procedures for drainage improvement credits and reimbursements as outlined in EPC DCM Chapter 3, Section 3.3 to determine the final reimbursement.



Table 2: Engineer's Opinion of Cost - Proposed Drainage Facilities

Item	Quantity	Unit	Unit Price	Totals
On-Site Drainage Facilities				
Inlet - Triple Type 13 Valley Inlet	1	EA	\$ 6,500	\$ 6,500.00
Inlet - 5' Curb Inlet	2	EA	\$ 7,059	\$ 14,118.00
18" RCP Storm Sewer	110	LF	\$ 70	\$ 7,700.00
24" RCP Storm Sewer	770	LF	\$ 83	\$ 63,910.00
18" RCP FES	1	EA	\$ 420	\$ 420.00
24" RCP FES	1	EA	\$ 498	\$ 498.00
Manhole - Storm Sewer - 4' Diameter	1	EA	\$ 6,500	\$ 6,500.00
Manhole - Storm Sewer - 5' Diameter	1	EA	\$ 7,082	\$ 7,082.00
Manhole - Storm Sewer - 6' Diameter	1	EA	\$ 12,876	\$ 12,876.00
Subtotal (On-Site Drainage Facilities):				\$ 119,604.00
Engineering (10%):				\$ 11,960.40
Contingency (5%):				\$ 5,980.20
Total				\$ 137,544.60
Storm Sewer Extention (Reimbursable)				
42" RCP Storm Sewer	369	LF	\$ 171	\$ 63,099.00
48" RCP Storm Sewer	797	LF	\$ 209	\$ 166,573.00
Manhole - Storm Sewer - 6' Diameter	6	EA	\$ 12,876	\$ 77,256.00
Forebay into Pond WU	1	LS	\$ 45,000	\$ 45,000.00
				\$ -
Subtotal (Storm Sewer Extension):				\$ 351,928.00
Engineering (10%):				\$ 35,192.80
Contingency (5%):				\$ 17,596.40
Total (Storm Sewer Extension):				\$ 404,717.20
Total (Overall):				\$ 542,261.80

(Reimbursable)

please remove reimburseable and add a separate note that a request will be submitted to the Drainage Board. Until adjudicated it cannot be listed as reiumburseable

APPENDIX B
Hydrologic Calculations
Runoff Coef, Time of Concentration and Runoff Calcs

U-Haul at Falcon
Runoff Coefficient and Percent Impervious Calculation

Basin / DP	Basin or DP Area (DP contributing basins)		Soil Type	PV	Area 1 Land Use			LA	Area 2 Land Use			RO	Area 3 Land Use			US1	Area 4 Land Use			Basin % Imperv	Basin Runoff Coef	
				% Imperv	Land Use Area	% Area	Comp Land Use % Imp	% Imperv	Land Use Area	% Area	Comp Land Use % Imp	% Imperv	Land Use Area	% Area	Comp Land Use % Imp	% Imperv	Land Use Area	% Area	Comp Land Use % Imp		C ₅	C ₁₀₀
EX-A	52,605 sf	1.21ac	AB	100%	-	0%	0%	2%	1.21ac	100%	2%	90%		0%	0%	85%		0%	0%	2.0%	0.08	0.36
EX-B	450,432 sf	10.34ac	AB	100%	0.06ac	1%	1%	2%	10.28ac	99%	2%	90%		0%	0%	85%		0%	0%	2.6%	0.08	0.37
EX-C	5,167 sf	0.12ac	AB	100%	-	0%	0%	2%	0.12ac	100%	2%	90%		0%	0%	85%		0%	0%	2.0%	0.08	0.36
OS-1	14,267 sf	0.33ac	AB	100%	0.33ac	100%	100%	2%		0%	0%	90%		0%	0%	85%		0%	0%	100.0%	0.90	0.96
DP 23	Falcon High Mkt	16.71ac	AB	100%	-	0%	0%	2%		0%	0%	90%		0%	0%	85%	16.71ac	100%	85%	85.0%	0.66	0.75
A	63,770 sf	1.46ac	AB	100%	1.19ac	82%	82%	2%	0.27ac	18%	0%	90%		0%	0%	85%		0%	0%	82.0%	0.62	0.72
B	88,406 sf	2.03ac	AB	100%	2.00ac	99%	99%	2%	0.03ac	1%	0%	90%		0%	0%	85%		0%	0%	98.6%	0.87	0.93
C	39,564 sf	0.91ac	AB	100%	0.62ac	68%	68%	2%	0.29ac	32%	1%	90%		0%	0%	85%		0%	0%	68.8%	0.48	0.61
D	6,867 sf	0.16ac	AB	100%	-	0%	0%	2%	0.16ac	100%	2%	90%		0%	0%	85%		0%	0%	2.0%	0.08	0.36
E	17,012 sf	0.39ac	AB	100%	-	0%	0%	2%		0%	0%	90%	0.39ac	100%	90%	85%		0%	0%	90.0%	0.73	0.81
F.1	12,132 sf	0.28ac	AB	100%	-	0%	0%	2%		0%	0%	90%	0.28ac	100%	90%	85%		0%	0%	90.0%	0.73	0.81
F.2	25,596 sf	0.59ac	AB	100%	-	0%	0%	2%		0%	0%	90%	0.59ac	100%	90%	85%		0%	0%	90.0%	0.73	0.81
G	25,629 sf	0.59ac	AB	100%	0.37ac	63%	63%	2%	0.22ac	37%	1%	90%		0%	0%	85%		0%	0%	63.6%	0.44	0.58
H	2,688 sf	0.06ac	AB	100%	0.06ac	100%	100%	2%		0%	0%	90%		0%	0%	85%		0%	0%	100.0%	0.90	0.96
J	28,188 sf	0.65ac	AB	100%	0.27ac	42%	42%	2%		0%	0%	90%	0.38ac	58%	53%	85%		0%	0%	94.2%	0.79	0.87
K	138,058 sf	3.17ac	AB	100%	0.62ac	19%	19%	2%	2.55ac	81%	2%	90%		0%	0%	85%		0%	0%	21.0%	0.20	0.44
K-Dev	138,058 sf	3.17ac	AB	100%	-	0%	0%	2%		0%	0%	90%		0%	0%	85%	3.17ac	100%	85%	85.0%	0.66	0.75
L	49,551 sf	1.14ac	AB	100%	-	0%	0%	2%	1.14ac	100%	2%	90%		0%	0%	85%		0%	0%	2.0%	0.08	0.36
L-Dev	49,551 sf	1.14ac	AB	100%	-	0%	0%	2%		0%	0%	90%		0%	0%	85%	1.14ac	100%	85%	85.0%	0.66	0.75
Property	501,112 sf	11.50ac	AB	100%	5.13ac	45%	45%	0%	5.12ac	44%	0%	90%	1.26ac	11%	10%	85%	-	0%	0%	54.4%	0.38	0.54

Basin Runoff Coefficient is based on % Imperviousness Calculation

Runoff Coefficients and Percents Impervious						
Hydrologic Soil Type:	AB	Runoff Coef Method			%Imp	
Land Use	Abb	%	C ₅	C ₁₀	C ₁₀₀	
Commercial Area	CO	95%	0.81	0.83	0.88	Weighted %Imp
Drives and Walks	DR	100%	0.90	0.92	0.96	
Streets - Gravel (Packed)	GR	80%	0.59	0.63	0.70	
Historic Flow Analysis	HI	2%	0.09	0.17	0.36	
Lawns	LA	2%	0.08	0.17	0.36	
Off-site flow-Undeveloped	OF	45%	0.32	0.38	0.51	
Park	PA	7%	0.12	0.20	0.39	
Streets - Paved	PV	100%	0.90	0.92	0.96	
Roofs	RO	90%	0.73	0.75	0.81	
User Input 1	US1	85%	0.66	0.69	0.75	
User Input 2	US2	65%	0.45	0.49	0.59	

Based on Table 6-6: Runoff Coefficients for Rational Method from City of Colo Springs DCM

U-Haul at Falcon
Time of Concentration Calculation

Sub-Basin Data				Time of Concentration Estimate										Min. Tc in Urban		Final t _c
Basin / Design Point	Contributing Basins	Area	C ₅	Initial/Overland Time (t _i)			Travel Time (t _t)					Comp.	Tc Check (urban)			
				Length	Slope	t _i	Length	Slope	Land Type	Cv	Velocity	t _t	t _c	Total Length	t _c Check	
EX-A		1.21ac	0.08	150lf	3.5%	15.0 min.	100lf	2.6%	SP	7	1.1ft/sec	1.5min.	16.5 min.	250lf	11.4 min.	11.4 min.
EX-B		10.34ac	0.08	150lf	1.3%	20.9 min.	940lf	1.3%	SP	7	0.8ft/sec	19.6min.	40.5 min.	1090lf	16.1 min.	16.1 min.
EX-C		0.12ac	0.08	40lf	1.0%	11.8 min.	150lf	1.5%	SP	7	0.9ft/sec	2.9min.	14.7 min.	190lf	11.1 min.	11.1 min.
OS-1		0.33ac	0.90	35lf	2.0%	1.8 min.	160lf	0.1%	PV	20	0.6ft/sec	4.2min.	6.0 min.	195lf	11.1 min.	6.0 min.
DP 23		16.71ac														10.5 min.
-		-	-			-										
A		1.46ac	0.62	40lf	5.0%	3.3 min.	410lf	2.0%	PV	20	2.8ft/sec	2.4min.	5.7 min.	450lf	12.5 min.	5.7 min.
B		2.03ac	0.87	60lf	2.2%	2.5 min.	320lf	2.2%	PV	20	3.0ft/sec	1.8min.	5.0 min.	380lf	12.1 min.	5.0 min.
C		0.91ac	0.48	60lf	4.2%	5.4 min.	370lf	1.7%	PV	20	2.6ft/sec	2.4min.	7.8 min.	430lf	12.4 min.	7.8 min.
D		0.16ac	0.08	20lf	7.5%	4.3 min.	110lf	1.0%	SP	7	0.7ft/sec	2.6min.	6.9 min.	130lf	10.7 min.	6.9 min.
E		0.39ac	0.73	60lf	1.0%	5.3 min.	50lf	1.0%	PV	20	2.0ft/sec	0.4min.	5.7 min.	110lf	10.6 min.	5.7 min.
F.1		0.28ac	0.73	70lf	1.0%	5.7 min.	60lf	1.0%	PV	20	2.0ft/sec	0.5min.	6.2 min.	130lf	10.7 min.	6.2 min.
F.2		0.59ac	0.73	70lf	1.0%	5.7 min.	60lf	1.0%	PV	20	2.0ft/sec	0.5min.	6.2 min.	130lf	10.7 min.	6.2 min.
G		0.59ac	0.44	35lf	1.4%	6.4 min.	150lf	0.8%	PV	20	1.8ft/sec	1.4min.	7.8 min.	185lf	11.0 min.	7.8 min.
H		0.06ac	0.90	25lf	6.2%	1.0 min.	75lf	1.0%	PV	20	2.0ft/sec	0.6min.	5.0 min.	100lf	10.6 min.	5.0 min.
J		0.65ac	0.79	50lf	1.8%	3.3 min.	130lf	1.3%	PV	20	2.3ft/sec	1.0min.	5.0 min.	180lf	11.0 min.	5.0 min.
K		3.17ac	0.20	40lf	3.8%	6.7 min.	650lf	1.4%	SP	7	0.8ft/sec	13.1min.	19.7 min.	690lf	13.8 min.	13.8 min.
K-Dev		3.17ac	0.66	40lf	3.8%	3.3 min.	650lf	1.4%	PV	20	2.4ft/sec	4.6min.	7.9 min.	690lf	13.8 min.	7.9 min.
L		1.14ac	0.08	70lf	3.0%	10.8 min.	360lf	2.2%	SP	7	1.0ft/sec	5.8min.	16.6 min.	430lf	12.4 min.	12.4 min.
L-Dev		1.14ac	0.66	70lf	3.0%	4.7 min.	360lf	2.2%	PV	20	3.0ft/sec	2.0min.	6.7 min.	430lf	12.4 min.	6.7 min.
-		-	-			-										

Equations:

$$t_i (\text{Overland}) = 0.395(1.1 - C_5)L^{0.5} S^{-0.333}$$

C₅ = Runoff coefficient for 5-year

L = Length of overland flow (ft)

S = Slope of flow path (ft/ft)

t_c Check = (L/180)+10 (Developed Cond. Only)

L = Overall Length

$$\text{Velocity (Travel Time)} = C_v S^{0.5}$$

C_v = Conveyance Coef (see table)

S = Watercourse slope (ft/ft)

Table 6-7: Conveyance Coef (City CS DCM, Vol 1)

Type of Land Surface	Land Type	Cv
Grassed Waterway	GW	15
Heavy Meadow	HM	2.5
Nearly Bare Ground	NBG	10
Paved Area	PV	20
Riprap (Not Buried)	RR	6.5
Short Pasture/Lawns	SP	7
Tillage/Fields	TF	5

**U-Haul at Falcon
Runoff Calculation**

Design Storm: 5 Year

Design Point	Direct Runoff							Total Runoff				Street/Chan		Pipe			Travel Time			Remarks
	Area Designation	Area	C	T _c	C*A (acre)	i (in/hr)	Q	T _c	Sum C*A	i (in/hr)	Q	Slope	Q	Q	Slope	Pipe Size	L (ft)	Vel (ft/s)	T _t	
DP 23 E1	EX-A	1.21ac	0.08	11.4min	0.10	3.9	0.4 cfs												---	
	EX-B	10.34ac	0.08	16.1min	0.86	3.4	3.0 cfs												---	
	EX-C	0.12ac	0.08	11.1min	0.01	4.0	0.0 cfs												---	
	OS-1	0.33ac	0.90	6.0min	0.29	4.9	1.4 cfs					1.8%	1.4 cfs				1125'	2.6	7.2min	to E1
	OS-1											2.9%	1.4 cfs				420'	5.8	1.2min	to DP2
			16.71ac		10.5min	9.86	4.1	40.0 cfs					0.7%	40.0 cfs			980'	4.3	3.8min	to E1
		23, EX-B, OS-1	10.67ac						16.1min	11.02	3.4	37.7 cfs								---
		A	1.46ac	0.62	5.7min	0.90	5.0	4.5 cfs				2.3%	4.5 cfs				20'	7.4	0.0min	to DP1
		B	2.03ac	0.87	5.0min	1.76	5.2	9.1 cfs												---
		C	0.91ac	0.48	7.8min	0.44	4.5	2.0 cfs												---
		D	0.16ac	0.08	6.9min	0.01	4.7	0.1 cfs												---
		E	0.39ac	0.73	5.7min	0.28	5.0	1.4 cfs				2.3%	1.4 cfs				30'	5.3	0.1min	to DP1
		F.1	0.28ac	0.73	6.2min	0.20	4.8	1.0 cfs				1.7%	1.0 cfs				95'	4.3	0.4min	to DP4
		F.2	0.59ac	0.73	6.2min	0.43	4.8	2.1 cfs				2.7%	2.1 cfs				65'	6.3	0.2min	to DP5
		G	0.59ac	0.44	7.8min	0.26	4.5	1.2 cfs												---
		H	0.06ac	0.90	5.0min	0.06	5.2	0.3 cfs												---
		J	0.65ac	0.79	5.0min	0.51	5.2	2.6 cfs												---
	K	3.17ac	0.20	13.8min	0.64	3.6	2.3 cfs												---	
	K-Dev	3.17ac	0.66	7.9min	2.08	4.5	9.3 cfs												---	
	L	1.14ac	0.08	12.4min	0.09	3.8	0.4 cfs												---	
	L-Dev	1.14ac	0.66	6.7min	0.75	4.7	3.5 cfs												---	
1	A, D, E	2.01ac						6.9min	1.20	4.7	5.6 cfs						195'	4.6	0.7min	DP1A
1A	H,DP1	2.07ac						7.6min	1.26	4.5	5.7 cfs						260'	4.7	0.9min	DP3
2	OS-1, B	2.36ac						7.2min	2.06	4.6	9.5 cfs		9.5 cfs	0.6%	18-in	152'	4.6	0.6min	S11	
3	DP1A, DP2	4.43ac						8.5min	3.31	4.4	14.5 cfs		14.5 cfs	0.6%	24-in	171'	5.6	0.5min	S13	
4	C, F.1	1.19ac						7.8min	0.64	4.5	2.9 cfs		2.9 cfs	0.8%	42-in	123'	9.1	0.2min	S15	
5	F.2, G	1.18ac						7.8min	0.69	4.5	3.1 cfs								---	
6	K, L	4.31ac						13.8min	0.73	3.6	2.7 cfs								---	
24	DP4, DP23	17.90ac						10.5min	10.50	4.1	42.6 cfs		42.6 cfs	0.8%	42-in	123'	9.1	0.2min	DP25	
25	DP5, DP24	19.07ac						10.7min	11.18	4.0	45.0 cfs		45.0 cfs	0.8%	42-in	258'	9.4	0.5min	DP26	
26	J, DP3, DP25	24.15ac						11.2min	15.01	4.0	59.5 cfs						410'	9	0.8min	DP27
27	L,DP26	25.29ac						11.9min	15.10	3.9	58.3 cfs						150'	9	0.3min	DP28
27-Dev	L-Dev,DP26	25.29ac						11.9min	15.76	3.9	60.9 cfs						150'	9	0.3min	DP28-Dev
28	K, DP27	28.46ac						12.2min	15.75	3.8	60.3 cfs								---	
28-Dev	K-Dev, DP27	28.46ac						12.2min	17.84	3.8	68.3 cfs								---	

Equations (taken from Fig 6-5, City of Colorado Springs DCM):

$$i_2 = -1.19 \ln(T_c) + 6.035$$

$$i_5 = -1.50 \ln(T_c) + 7.583$$

$$i_{10} = -1.75 \ln(T_c) + 8.847$$

$$i_{100} = -2.52 \ln(T_c) + 12.735$$

Q = CiA

Q = Peak Runoff Rate (cubic feet/second)

C = Runoff coef representing a ration of peak runoff rate to ave rainfall intensity for a duration equal to the runoff time of concentration.

i = average rainfall intensity in inches per hour

A = Drainage area in acres

**U-Haul at Falcon
Runoff Calculation**

Design Storm: 100 Yr

Design Point	Direct Runoff							Total Runoff				Street/Chan		Pipe			Travel Time			Remarks	
	Area Designation	Area	C	T _c	C*A (acre)	i (in/hr)	Q	T _c	C*A	i (in/hr)	Q	Slope	Q	Q	Slope	Pipe Size	L (ft)	Vel (ft/s)	T _t		
DP 23 E1	EX-A	1.21ac	0.36	11.4min	0.44	6.6	2.9 cfs												---		
	EX-B	10.34ac	0.37	16.1min	3.78	5.7	21.7 cfs												---		
	EX-C	0.12ac	0.36	11.1min	0.04	6.7	0.3 cfs												---		
	OS-1	0.33ac	0.96	6.0min	0.31	8.2	2.6 cfs					1.8%	2.6 cfs				1125'	2.6	7.2min	to E1	
												2.9%	2.6 cfs				420'	5.8	1.2min	to DP2	
			16.71ac		10.5min	10.41	6.8	70.9 cfs	Falcon Highlands Markt Place Flg 1				0.7%	70.9 cfs				980'	4.3	3.8min	to E1
		23, EX-B, OS-1	10.67ac					16.1min	14.51	5.7	83.3 cfs									---	
		A	1.46ac	0.72	5.7min	1.05	8.4	8.8 cfs				2.3%	8.8 cfs				20'	7.4	0.0min	to DP1	
		B	2.03ac	0.93	5.0min	1.89	8.7	16.4 cfs												---	
		C	0.91ac	0.61	7.8min	0.56	7.6	4.2 cfs												---	
		D	0.16ac	0.36	6.9min	0.06	7.9	0.4 cfs												---	
		E	0.39ac	0.81	5.7min	0.32	8.3	2.6 cfs				2.3%	2.6 cfs				30'	5.3	0.1min	to DP1	
		F.1	0.28ac	0.81	6.2min	0.23	8.1	1.8 cfs				1.7%	1.8 cfs				95'	4.3	0.4min	to DP4	
		F.2	0.59ac	0.81	6.2min	0.48	8.1	3.9 cfs				2.7%	3.9 cfs				65'	6.3	0.2min	to DP5	
		G	0.59ac	0.58	7.8min	0.34	7.6	2.6 cfs												---	
		H	0.06ac	0.96	5.0min	0.06	8.7	0.5 cfs												---	
		J	0.65ac	0.87	5.0min	0.56	8.7	4.9 cfs												---	
	K	3.17ac	0.44	13.8min	1.41	6.1	8.6 cfs												---		
	K-Dev	3.17ac	0.75	7.9min	2.38	7.5	17.9 cfs												---		
	L	1.14ac	0.36	12.4min	0.41	6.4	2.6 cfs												---		
	L-Dev	1.14ac	0.75	6.7min	0.85	7.9	6.8 cfs												---		
1	A, D, E	2.01ac					6.9min	1.43	7.9	11.2 cfs						195'	4.6	0.7min	DP1A		
1A	H,DP1	2.07ac					7.6min	1.49	7.6	11.3 cfs						260'	4.7	0.9min	DP3		
2	OS-1, B	2.36ac					7.2min	2.20	7.8	17.1 cfs			17.1 cfs	0.6%	18-in	152'	4.6	0.6min	S11		
3	DP1A, DP2	4.43ac					7.7min	3.69	7.6	28.0 cfs			28.0 cfs	0.6%	24-in	171'	5.6	0.5min	S13		
4	C, F.1	1.19ac					7.8min	0.78	7.6	5.9 cfs			5.9 cfs	0.8%	42-in	123'	9.1	0.2min	S15		
5	F.2, G	1.18ac					7.8min	0.82	7.6	6.2 cfs									---		
6	K, L	4.31ac					13.8min	1.82	6.1	11.1 cfs									---		
24	DP4, DP23	17.90ac					10.5min	11.19	6.8	76.2 cfs			76.2 cfs	0.8%	42-in	123'	9.1	0.2min	DP25		
25	DP5, DP24	19.07ac					10.7min	12.01	6.8	81.1 cfs			81.1 cfs	0.8%	42-in	258'	9.4	0.5min	DP26		
26	J, DP3, DP25	24.15ac					11.2min	16.26	6.7	108.1 cfs						410'	9	0.8min	DP27		
27	L, DP26	25.29ac					11.9min	16.67	6.5	108.1 cfs						150'	9	0.3min	DP28		
27-Dev	L-Dev, DP26	25.29ac					11.9min	17.53	6.5	113.7 cfs						150'	9	0.3min	DP28-Dev		
28	K, DP27	28.46ac					12.2min	18.08	6.4	116.2 cfs									---		
28-Dev	K-Dev, DP27	28.46ac					12.2min	19.91	6.4	127.9 cfs									---		

Equations (taken from Fig 6-5, City of Colorado Springs DCM):

$$i_2 = -1.19 \ln(T_c) + 6.035$$

$$i_5 = -1.50 \ln(T_c) + 7.583$$

$$i_{10} = -1.75 \ln(T_c) + 8.847$$

$$i_{100} = -2.52 \ln(T_c) + 12.735$$

Q = CiA

Q = Peak Runoff Rate (cubic feet/second)

C = Runoff coef representing a ration of peak runoff rate to ave rainfall intensity for a duration equal to the runoff time of concentration.

i = average rainfall intensity in inches per hour

A = Drainage area in acres

APPENDIX B.1
Supporting Tables and Figures

Table 6-6. Runoff Coefficients for Rational Method
(Source: UDFCD 2001)

Land Use or Surface Characteristics	Percent Impervious	Runoff Coefficients											
		2-year		5-year		10-year		25-year		50-year		100-year	
		HSG A&B	HSG C&D	HSG A&B	HSG C&D	HSG A&B	HSG C&D	HSG A&B	HSG C&D	HSG A&B	HSG C&D	HSG A&B	HSG C&D
Business													
Commercial Areas	95	0.79	0.80	0.81	0.82	0.83	0.84	0.85	0.87	0.87	0.88	0.88	0.89
Neighborhood Areas	70	0.45	0.49	0.49	0.53	0.53	0.57	0.58	0.62	0.60	0.65	0.62	0.68
Residential													
1/8 Acre or less	65	0.41	0.45	0.45	0.49	0.49	0.54	0.54	0.59	0.57	0.62	0.59	0.65
1/4 Acre	40	0.23	0.28	0.30	0.35	0.36	0.42	0.42	0.50	0.46	0.54	0.50	0.58
1/3 Acre	30	0.18	0.22	0.25	0.30	0.32	0.38	0.39	0.47	0.43	0.52	0.47	0.57
1/2 Acre	25	0.15	0.20	0.22	0.28	0.30	0.36	0.37	0.46	0.41	0.51	0.46	0.56
1 Acre	20	0.12	0.17	0.20	0.26	0.27	0.34	0.35	0.44	0.40	0.50	0.44	0.55
Industrial													
Light Areas	80	0.57	0.60	0.59	0.63	0.63	0.66	0.66	0.70	0.68	0.72	0.70	0.74
Heavy Areas	90	0.71	0.73	0.73	0.75	0.75	0.77	0.78	0.80	0.80	0.82	0.81	0.83
Parks and Cemeteries	7	0.05	0.09	0.12	0.19	0.20	0.29	0.30	0.40	0.34	0.46	0.39	0.52
Playgrounds	13	0.07	0.13	0.16	0.23	0.24	0.31	0.32	0.42	0.37	0.48	0.41	0.54
Railroad Yard Areas	40	0.23	0.28	0.30	0.35	0.36	0.42	0.42	0.50	0.46	0.54	0.50	0.58
Undeveloped Areas													
Historic Flow Analysis-- Greenbelts, Agriculture	2	0.03	0.05	0.09	0.16	0.17	0.26	0.26	0.38	0.31	0.45	0.36	0.51
Pasture/Meadow	0	0.02	0.04	0.08	0.15	0.15	0.25	0.25	0.37	0.30	0.44	0.35	0.50
Forest	0	0.02	0.04	0.08	0.15	0.15	0.25	0.25	0.37	0.30	0.44	0.35	0.50
Exposed Rock	100	0.89	0.89	0.90	0.90	0.92	0.92	0.94	0.94	0.95	0.95	0.96	0.96
Offsite Flow Analysis (when landuse is undefined)	45	0.26	0.31	0.32	0.37	0.38	0.44	0.44	0.51	0.48	0.55	0.51	0.59
Streets													
Paved	100	0.89	0.89	0.90	0.90	0.92	0.92	0.94	0.94	0.95	0.95	0.96	0.96
Gravel	80	0.57	0.60	0.59	0.63	0.63	0.66	0.66	0.70	0.68	0.72	0.70	0.74
Drive and Walks	100	0.89	0.89	0.90	0.90	0.92	0.92	0.94	0.94	0.95	0.95	0.96	0.96
Roofs	90	0.71	0.73	0.73	0.75	0.75	0.77	0.78	0.80	0.80	0.82	0.81	0.83
Lawns	0	0.02	0.04	0.08	0.15	0.15	0.25	0.25	0.37	0.30	0.44	0.35	0.50

3.2 Time of Concentration

One of the basic assumptions underlying the Rational Method is that runoff is a function of the average rainfall rate during the time required for water to flow from the hydraulically most remote part of the drainage area under consideration to the design point. However, in practice, the time of concentration can be an empirical value that results in reasonable and acceptable peak flow calculations.

For urban areas, the time of concentration (t_c) consists of an initial time or overland flow time (t_i) plus the travel time (t_t) in the storm sewer, paved gutter, roadside drainage ditch, or drainage channel. For non-urban areas, the time of concentration consists of an overland flow time (t_i) plus the time of travel in a concentrated form, such as a swale or drainageway. The travel portion (t_t) of the time of concentration can be estimated from the hydraulic properties of the storm sewer, gutter, swale, ditch, or drainageway. Initial time, on the other hand, will vary with surface slope, depression storage, surface cover, antecedent rainfall, and infiltration capacity of the soil, as well as distance of surface flow. The time of concentration is represented by Equation 6-7 for both urban and non-urban areas.

For Colorado Springs and much of the Fountain Creek watershed, the 1-hour depths are fairly uniform and are summarized in Table 6-2. Depending on the location of the project, rainfall depths may be calculated using the described method and the NOAA Atlas maps shown in Figures 6-6 through 6-17.

Table 6-2. Rainfall Depths for Colorado Springs

Return Period	1-Hour Depth	6-Hour Depth	24-Hour Depth
2	1.19	1.70	2.10
5	1.50	2.10	2.70
10	1.75	2.40	3.20
25	2.00	2.90	3.60
50	2.25	3.20	4.20
100	2.52	3.50	4.60

Where $Z = 6,840 \text{ ft}/100$

These depths can be applied to the design storms or converted to intensities (inches/hour) for the Rational Method as described below. However, as the basin area increases, it is unlikely that the reported point rainfalls will occur uniformly over the entire basin. To account for this characteristic of rain storms an adjustment factor, the Depth Area Reduction Factor (DARF) is applied. This adjustment to rainfall depth and its effect on design storms is also described below. The UDFCD UD-Rain spreadsheet, available on UDFCD's website, also provides tools to calculate point rainfall depths and Intensity-Duration-Frequency curves² and should produce similar depth calculation results.

2.2 Design Storms

Design storms are used as input into rainfall/runoff models and provide a representation of the typical temporal distribution of rainfall events when the creation or routing of runoff hydrographs is required. It has long been observed that rainstorms in the Front Range of Colorado tend to occur as either short-duration, high-intensity, localized, convective thunderstorms (cloud bursts) or longer-duration, lower-intensity, broader, frontal (general) storms. The significance of these two types of events is primarily determined by the size of the drainage basin being studied. Thunderstorms can create high rates of runoff within a relatively small area, quickly, but their influence may not be significant very far downstream. Frontal storms may not create high rates of runoff within smaller drainage basins due to their lower intensity, but tend to produce larger flood flows that can be hazardous over a broader area and extend further downstream.

- **Thunderstorms:** Based on the extensive evaluation of rain storms completed in the Carlton study (Carlton 2011), it was determined that typical thunderstorms have a duration of about 2 hours. The study evaluated over 300,000 storm cells using gage-adjusted NEXRAD data, collected over a 14-year period (1994 to 2008). Storms lasting longer than 3 hours were rarely found. Therefore, the results of the Carlton study have been used to define the shorter duration design storms.

To determine the temporal distribution of thunderstorms, 22 gage-adjusted NEXRAD storm cells were studied in detail. Through a process described in a technical memorandum prepared by the City of Colorado Springs (City of Colorado Springs 2012), the results of this analysis were interpreted and normalized to the 1-hour rainfall depth to create the distribution shown in Table 6-3 with a 5 minute time interval for drainage basins up to 1 square mile in size. This distribution represents the rainfall

Figure 6-5. Colorado Springs Rainfall Intensity Duration Frequency

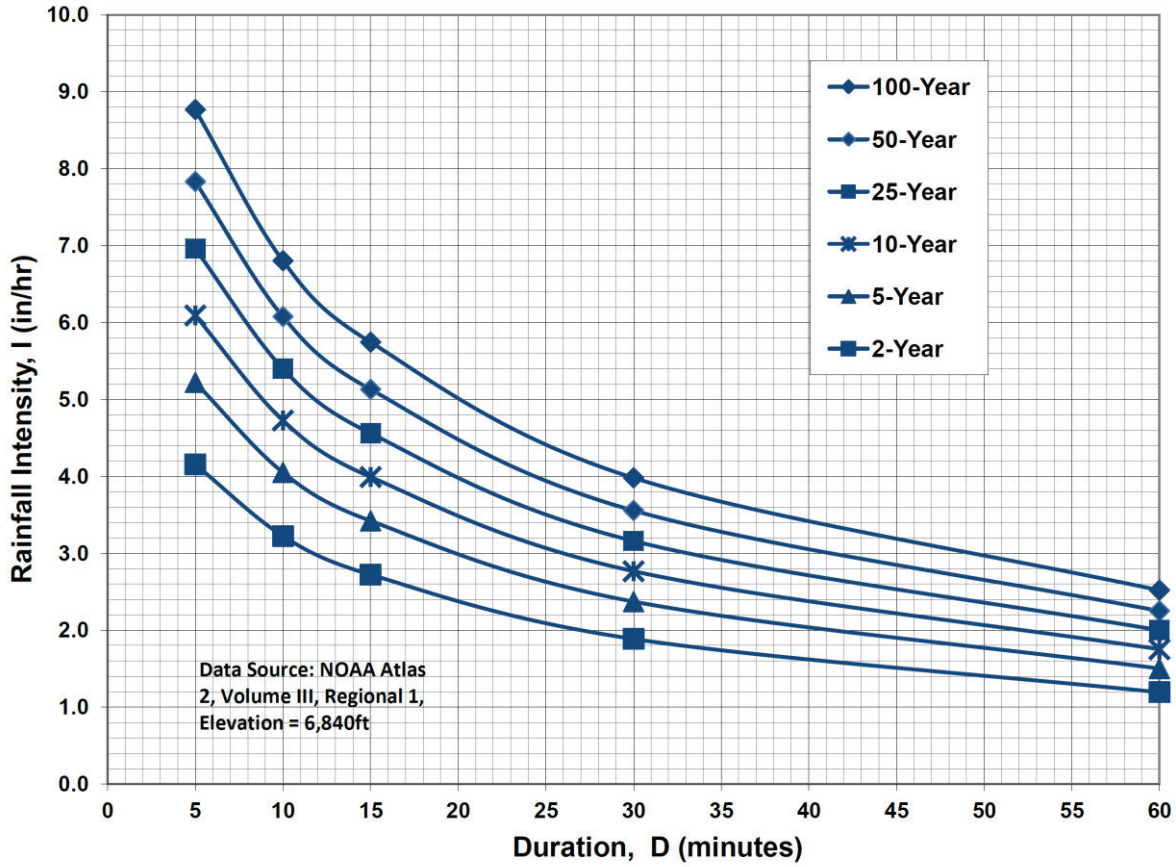

IDF Equations

$$I_{100} = -2.52 \ln(D) + 12.735$$

$$I_{50} = -2.25 \ln(D) + 11.375$$

$$I_{25} = -2.00 \ln(D) + 10.111$$

$$I_{10} = -1.75 \ln(D) + 8.847$$

$$I_5 = -1.50 \ln(D) + 7.583$$

$$I_2 = -1.19 \ln(D) + 6.035$$

Note: Values calculated by equations may not precisely duplicate values read from figure.

APPENDIX C
Hydraulic Calculations
Inlet Summary and Capacity Calculations – UD-Inlet
Pipe Sizing Calculations

INLET MANAGEMENT

Worksheet Protected

INLET NAME	Inlet 10	Inlet 11	Inlet 16
Site Type (Urban or Rural)	URBAN	URBAN	URBAN
Inlet Application (Street or Area)	AREA	STREET	STREET
Hydraulic Condition	Swale	In Sump	In Sump
Inlet Type	CDOT Type C	CDOT/Denver 13 Valley Grate	CDOT/Denver 13 Combination

USER-DEFINED INPUT

User-Defined Design Flows

Minor Q_{known} (cfs)	5.9	9.5	3.1
Major Q_{known} (cfs)	11.8	17.1	6.2

Bypass (Carry-Over) Flow from Upstream

Receive Bypass Flow from:	No Bypass Flow Received	No Bypass Flow Received	No Bypass Flow Received
Minor Bypass Flow Received, Q_b (cfs)	0.0	0.0	0.0
Major Bypass Flow Received, Q_b (cfs)	0.0	0.0	0.0

Watershed Characteristics

Subcatchment Area (acres)			
Percent Impervious			
NRCS Soil Type			

Watershed Profile

Overland Slope (ft/ft)			
Overland Length (ft)			
Channel Slope (ft/ft)			
Channel Length (ft)			

Minor Storm Rainfall Input

Design Storm Return Period, T_r (years)			
One-Hour Precipitation, P_1 (inches)			

Major Storm Rainfall Input

Design Storm Return Period, T_r (years)			
One-Hour Precipitation, P_1 (inches)			

CALCULATED OUTPUT

Minor Total Design Peak Flow, Q (cfs)	5.9	9.5	3.1
Major Total Design Peak Flow, Q (cfs)	11.8	17.1	6.2
Minor Flow Bypassed Downstream, Q_b (cfs)	0.0	N/A	N/A
Major Flow Bypassed Downstream, Q_b (cfs)	0.0	N/A	N/A

INLET MANAGEMENT

Worksheet Protected

INLET NAME	Inlet 17
Site Type (Urban or Rural)	URBAN
Inlet Application (Street or Area)	STREET
Hydraulic Condition	In Sump
Inlet Type	CDOT/Denver 13 Combination

USER-DEFINED INPUT

User-Defined Design Flows	
Minor Q_{Known} (cfs)	17.3
Major Q_{Known} (cfs)	32.5
Bypass (Carry-Over) Flow from Upstream	
Receive Bypass Flow from:	No Bypass Flow Received
Minor Bypass Flow Received, Q_b (cfs)	0.0
Major Bypass Flow Received, Q_b (cfs)	0.0
Watershed Characteristics	
Subcatchment Area (acres)	
Percent Impervious	
NRCS Soil Type	
Watershed Profile	
Overland Slope (ft/ft)	
Overland Length (ft)	
Channel Slope (ft/ft)	
Channel Length (ft)	
Minor Storm Rainfall Input	
Design Storm Return Period, T_r (years)	
One-Hour Precipitation, P_1 (inches)	
Major Storm Rainfall Input	
Design Storm Return Period, T_r (years)	
One-Hour Precipitation, P_1 (inches)	

CALCULATED OUTPUT

Minor Total Design Peak Flow, Q (cfs)	17.3
Major Total Design Peak Flow, Q (cfs)	32.5
Minor Flow Bypassed Downstream, Q_b (cfs)	N/A
Major Flow Bypassed Downstream, Q_b (cfs)	N/A

MHFD-Inlet, Version 5.01 (April 2021)
AREA INLET IN A SWALE

**U-Haul Falcon
 Inlet 10**

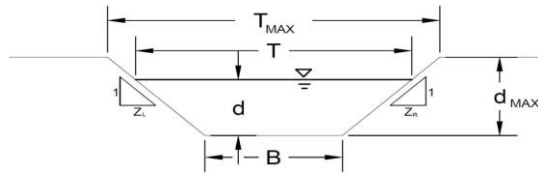

This worksheet uses the NRCS vegetal retardance method to determine Manning's n.
 For more information see Section 7.2.3 of the USDCM.

Analysis of Trapezoidal Grass-Lined Channel Using SCS Method														
NRCS Vegetal Retardance (A, B, C, D, or E)														
Manning's n (Leave cell D16 blank to manually enter an n value)														
Channel Invert Slope														
Bottom Width														
Left Side Slope														
Right Side Slope														
Check one of the following soil types:														
Soil Type:	Max. Velocity (V _{MAX})	Max Froude No. (F _{MAX})												
Non-Cohesive	5.0 fps	0.60												
Cohesive	7.0 fps	0.80												
Paved	N/A	N/A												
<table border="1"> <tr> <td>A, B, C, D, or E =</td> <td></td> </tr> <tr> <td>n =</td> <td>0.035</td> </tr> <tr> <td>S₀ =</td> <td>0.0150 ft/ft</td> </tr> <tr> <td>B =</td> <td>2.00 ft</td> </tr> <tr> <td>Z1 =</td> <td>4.00 ft/ft</td> </tr> <tr> <td>Z2 =</td> <td>4.00 ft/ft</td> </tr> </table>			A, B, C, D, or E =		n =	0.035	S ₀ =	0.0150 ft/ft	B =	2.00 ft	Z1 =	4.00 ft/ft	Z2 =	4.00 ft/ft
A, B, C, D, or E =														
n =	0.035													
S ₀ =	0.0150 ft/ft													
B =	2.00 ft													
Z1 =	4.00 ft/ft													
Z2 =	4.00 ft/ft													
Choose One:														
<input type="radio"/> Non-Cohesive <input checked="" type="radio"/> Cohesive <input type="radio"/> Paved														
<table border="1"> <tr> <td></td> <td>Minor Storm</td> <td>Major Storm</td> </tr> <tr> <td>T_{MAX} =</td> <td>8.00</td> <td>10.00</td> </tr> <tr> <td>d_{MAX} =</td> <td>0.55</td> <td>1.00</td> </tr> </table>				Minor Storm	Major Storm	T _{MAX} =	8.00	10.00	d _{MAX} =	0.55	1.00			
	Minor Storm	Major Storm												
T _{MAX} =	8.00	10.00												
d _{MAX} =	0.55	1.00												
<table border="1"> <tr> <td></td> <td>Minor Storm</td> <td>Major Storm</td> </tr> <tr> <td>Q_{allow} =</td> <td>6.0</td> <td>21.9</td> </tr> <tr> <td>d_{allow} =</td> <td>0.55</td> <td>1.00</td> </tr> </table>				Minor Storm	Major Storm	Q _{allow} =	6.0	21.9	d _{allow} =	0.55	1.00			
	Minor Storm	Major Storm												
Q _{allow} =	6.0	21.9												
d _{allow} =	0.55	1.00												
<table border="1"> <tr> <td></td> <td>Minor Storm</td> <td>Major Storm</td> </tr> <tr> <td>Q_o =</td> <td>5.9</td> <td>11.8</td> </tr> <tr> <td>d =</td> <td>0.54</td> <td>0.76</td> </tr> </table>				Minor Storm	Major Storm	Q _o =	5.9	11.8	d =	0.54	0.76			
	Minor Storm	Major Storm												
Q _o =	5.9	11.8												
d =	0.54	0.76												
Allowable Channel Capacity Based On Channel Geometry MINOR STORM Allowable Capacity is based on Depth Criterion MAJOR STORM Allowable Capacity is based on Depth Criterion														
Water Depth in Channel Based On Design Peak Flow Design Peak Flow Water Depth														
<p>Minor storm max. allowable capacity GOOD - greater than the design flow given on sheet 'Inlet Management' Major storm max. allowable capacity GOOD - greater than the design flow given on sheet 'Inlet Management'</p>														

MHFD-Inlet, Version 5.01 (April 2021)
AREA INLET IN A SWALE

U-Haul Falcon
Inlet 10

Inlet Design Information (Input)																					
Type of Inlet	CDOT Type C																				
Inlet Type =	CDOT Type C																				
Angle of Inclined Grate (must be ≤ 30 degrees)	$\theta = 0.00$ degrees																				
Width of Grate	$W = 3.00$ ft																				
Length of Grate	$L = 3.00$ ft																				
Open Area Ratio	$A_{RATIO} = 0.70$																				
Height of Inclined Grate	$H_B = 0.00$ ft																				
Clogging Factor	$C_f = 0.50$																				
Grate Discharge Coefficient	$C_d = 0.96$																				
Orifice Coefficient	$C_o = 0.64$																				
Weir Coefficient	$C_w = 2.05$																				
	<table border="1"> <thead> <tr> <th></th> <th>MINOR</th> <th>MAJOR</th> <th></th> </tr> </thead> <tbody> <tr> <td>$d =$</td> <td>0.54</td> <td>0.76</td> <td></td> </tr> <tr> <td>$Q_a =$</td> <td>7.4</td> <td>12.1</td> <td>cfs</td> </tr> <tr> <td>$Q_b =$</td> <td>0.0</td> <td>0.0</td> <td>cfs</td> </tr> <tr> <td>$C\% =$</td> <td>100</td> <td>100</td> <td>%</td> </tr> </tbody> </table>		MINOR	MAJOR		$d =$	0.54	0.76		$Q_a =$	7.4	12.1	cfs	$Q_b =$	0.0	0.0	cfs	$C\% =$	100	100	%
	MINOR	MAJOR																			
$d =$	0.54	0.76																			
$Q_a =$	7.4	12.1	cfs																		
$Q_b =$	0.0	0.0	cfs																		
$C\% =$	100	100	%																		
Water Depth at Inlet (for depressed inlets, 1 foot is added for depression)																					
Total Inlet Interception Capacity (assumes clogged condition)																					
Bypassed Flow																					
Capture Percentage = Q_a/Q_o																					

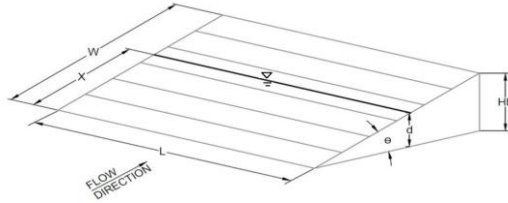

ALLOWABLE CAPACITY FOR ONE-HALF OF STREET (Minor & Major Storm)
 (Based on Regulated Criteria for Maximum Allowable Flow Depth and Spread)

Project: U-Haul Falcon
 Inlet ID: Inlet 11

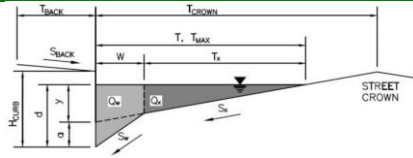

Gutter Geometry:																	
Maximum Allowable Width for Spread Behind Curb	$T_{BACK} = 20.0$ ft																
Side Slope Behind Curb (leave blank for no conveyance credit behind curb)	$S_{BACK} = 0.020$ ft/ft																
Manning's Roughness Behind Curb (typically between 0.012 and 0.020)	$n_{BACK} = 0.015$																
Height of Curb at Gutter Flow Line	$H_{CURB} = 0.00$ inches																
Distance from Curb Face to Street Crown	$T_{CROWN} = 30.0$ ft																
Gutter Width	$W = 2.00$ ft																
Street Transverse Slope	$S_x = 0.025$ ft/ft																
Gutter Cross Slope (typically 2 inches over 24 inches or 0.083 ft/ft)	$S_y = 0.040$ ft/ft																
Street Longitudinal Slope - Enter 0 for sump condition	$S_o = 0.000$ ft/ft																
Manning's Roughness for Street Section (typically between 0.012 and 0.020)	$n_{STREET} = 0.015$																
	<table border="1"> <tr> <td></td> <td>Minor Storm</td> <td>Major Storm</td> <td></td> </tr> <tr> <td>$T_{MAX} =$</td> <td>15.0</td> <td>20.0</td> <td>ft</td> </tr> <tr> <td>$d_{MAX} =$</td> <td>6.0</td> <td>12.0</td> <td>inches</td> </tr> <tr> <td></td> <td><input type="checkbox"/></td> <td><input type="checkbox"/></td> <td></td> </tr> </table>		Minor Storm	Major Storm		$T_{MAX} =$	15.0	20.0	ft	$d_{MAX} =$	6.0	12.0	inches		<input type="checkbox"/>	<input type="checkbox"/>	
	Minor Storm	Major Storm															
$T_{MAX} =$	15.0	20.0	ft														
$d_{MAX} =$	6.0	12.0	inches														
	<input type="checkbox"/>	<input type="checkbox"/>															
Max. Allowable Spread for Minor & Major Storm																	
Max. Allowable Depth at Gutter Flowline for Minor & Major Storm																	
Check boxes are not applicable in SUMP conditions																	
MINOR STORM Allowable Capacity is based on Depth Criterion																	
MAJOR STORM Allowable Capacity is based on Depth Criterion																	
	<table border="1"> <tr> <td></td> <td>Minor Storm</td> <td>Major Storm</td> <td></td> </tr> <tr> <td>$Q_{allow} =$</td> <td>SUMP</td> <td>SUMP</td> <td>cfs</td> </tr> </table>		Minor Storm	Major Storm		$Q_{allow} =$	SUMP	SUMP	cfs								
	Minor Storm	Major Storm															
$Q_{allow} =$	SUMP	SUMP	cfs														

Warning 02

INLET IN A SUMP OR SAG LOCATION

MHFD-Inlet, Version 5.01 (April 2021)

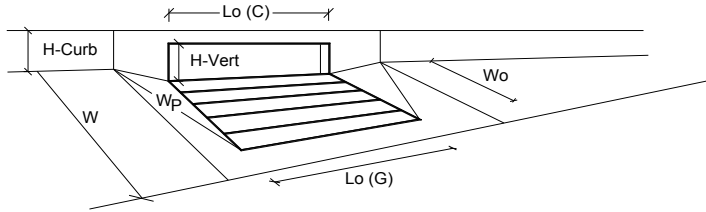

Design Information (Input)	MINOR	MAJOR	
Type of Inlet	CDOT/Denver 13 Valley Grate		
Local Depression (additional to continuous gutter depression 'a' from above)	2.00	2.00	inches
Number of Unit Inlets (Grate or Curb Opening)	3	3	
Water Depth at Flowline (outside of local depression)	8.0	10.3	inches
Grate Information			
Length of a Unit Grate	3.00	3.00	feet
Width of a Unit Grate	1.73	1.73	feet
Area Opening Ratio for a Grate (typical values 0.15-0.90)	0.43	0.43	
Clogging Factor for a Single Grate (typical value 0.50 - 0.70)	0.50	0.50	
Grate Weir Coefficient (typical value 2.15 - 3.60)	3.30	3.30	
Grate Orifice Coefficient (typical value 0.60 - 0.80)	0.60	0.60	
Curb Opening Information			
Length of a Unit Curb Opening	N/A	N/A	feet
Height of Vertical Curb Opening in Inches	N/A	N/A	inches
Height of Curb Orifice Throat in Inches	N/A	N/A	inches
Angle of Throat (see USDCM Figure ST-5)	N/A	N/A	degrees
Side Width for Depression Pan (typically the gutter width of 2 feet)	N/A	N/A	feet
Clogging Factor for a Single Curb Opening (typical value 0.10)	N/A	N/A	
Curb Opening Weir Coefficient (typical value 2.3-3.7)	N/A	N/A	
Curb Opening Orifice Coefficient (typical value 0.60 - 0.70)	N/A	N/A	
Low Head Performance Reduction (Calculated)			
Depth for Grate Midwidth	0.727	0.918	ft
Depth for Curb Opening Weir Equation	N/A	N/A	ft
Combination Inlet Performance Reduction Factor for Long Inlets	N/A	N/A	
Curb Opening Performance Reduction Factor for Long Inlets	N/A	N/A	
Grated Inlet Performance Reduction Factor for Long Inlets	0.75	0.97	
Total Inlet Interception Capacity (assumes clogged condition)			
Inlet Capacity IS GOOD for Minor and Major Storms(>Q PEAK)	9.5	17.4	cfs
Q _{PEAK REQUIRED}	9.5	17.1	cfs

ALLOWABLE CAPACITY FOR ONE-HALF OF STREET (Minor & Major Storm)
 (Based on Regulated Criteria for Maximum Allowable Flow Depth and Spread)

Project: U-Haul Falcon
 Inlet ID: Inlet 16

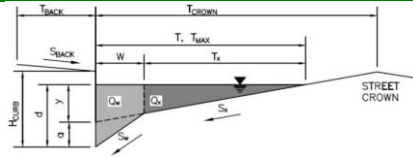

Gutter Geometry:													
Maximum Allowable Width for Spread Behind Curb	$T_{BACK} = 30.0$ ft												
Side Slope Behind Curb (leave blank for no conveyance credit behind curb)	$S_{BACK} = 0.020$ ft/ft												
Manning's Roughness Behind Curb (typically between 0.012 and 0.020)	$n_{BACK} = 0.015$												
Height of Curb at Gutter Flow Line	$H_{CURB} = 6.00$ inches												
Distance from Curb Face to Street Crown	$T_{CROWN} = 60.0$ ft												
Gutter Width	$W = 1.73$ ft												
Street Transverse Slope	$S_x = 0.020$ ft/ft												
Gutter Cross Slope (typically 2 inches over 24 inches or 0.083 ft/ft)	$S_g = 0.040$ ft/ft												
Street Longitudinal Slope - Enter 0 for sump condition	$S_o = 0.000$ ft/ft												
Manning's Roughness for Street Section (typically between 0.012 and 0.020)	$n_{STREET} = 0.015$												
Max. Allowable Spread for Minor & Major Storm	<table border="1"> <tr> <th></th> <th>Minor Storm</th> <th>Major Storm</th> <th></th> </tr> <tr> <td>T_{MAX}</td> <td>10.0</td> <td>40.0</td> <td>ft</td> </tr> <tr> <td>d_{MAX}</td> <td>6.0</td> <td>12.0</td> <td>inches</td> </tr> </table>		Minor Storm	Major Storm		T_{MAX}	10.0	40.0	ft	d_{MAX}	6.0	12.0	inches
	Minor Storm	Major Storm											
T_{MAX}	10.0	40.0	ft										
d_{MAX}	6.0	12.0	inches										
Max. Allowable Depth at Gutter Flowline for Minor & Major Storm													
Check boxes are not applicable in SUMP conditions	<input type="checkbox"/> <input type="checkbox"/>												
MINOR STORM Allowable Capacity is based on Depth Criterion													
MAJOR STORM Allowable Capacity is based on Depth Criterion													
	<table border="1"> <tr> <th></th> <th>Minor Storm</th> <th>Major Storm</th> <th></th> </tr> <tr> <td>Q_{allow}</td> <td>SUMP</td> <td>SUMP</td> <td>cfs</td> </tr> </table>		Minor Storm	Major Storm		Q_{allow}	SUMP	SUMP	cfs				
	Minor Storm	Major Storm											
Q_{allow}	SUMP	SUMP	cfs										

INLET IN A SUMP OR SAG LOCATION

MHFD-Inlet, Version 5.01 (April 2021)

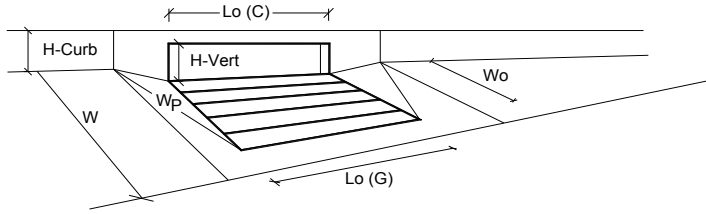

Design Information (Input)	MINOR	MAJOR	
Type of Inlet	CDOT/Denver 13 Combination		
Local Depression (additional to continuous gutter depression 'a' from above)	2.00	2.00	inches
Number of Unit Inlets (Grate or Curb Opening)	1	1	
Water Depth at Flowline (outside of local depression)	5.3	10.0	inches
Grate Information			
Length of a Unit Grate	3.00	3.00	feet
Width of a Unit Grate	1.73	1.73	feet
Area Opening Ratio for a Grate (typical values 0.15-0.90)	0.43	0.43	
Clogging Factor for a Single Grate (typical value 0.50 - 0.70)	0.50	0.50	
Grate Weir Coefficient (typical value 2.15 - 3.60)	3.30	3.30	
Grate Orifice Coefficient (typical value 0.60 - 0.80)	0.60	0.60	
Curb Opening Information			
Length of a Unit Curb Opening	3.00	3.00	feet
Height of Vertical Curb Opening in Inches	6.50	6.50	inches
Height of Curb Orifice Throat in Inches	5.25	5.25	inches
Angle of Throat (see USDCM Figure ST-5)	0.00	0.00	degrees
Side Width for Depression Pan (typically the gutter width of 2 feet)	1.00	1.00	feet
Clogging Factor for a Single Curb Opening (typical value 0.10)	0.10	0.10	
Curb Opening Weir Coefficient (typical value 2.3-3.7)	3.70	3.70	
Curb Opening Orifice Coefficient (typical value 0.60 - 0.70)	0.66	0.66	
Low Head Performance Reduction (Calculated)			
Depth for Grate Midwidth	0.490	0.883	ft
Depth for Curb Opening Weir Equation	0.37	0.77	ft
Combination Inlet Performance Reduction Factor for Long Inlets	0.83	1.00	
Curb Opening Performance Reduction Factor for Long Inlets	1.00	1.00	
Grated Inlet Performance Reduction Factor for Long Inlets	0.83	1.00	
Total Inlet Interception Capacity (assumes clogged condition)			
Inlet Capacity IS GOOD for Minor and Major Storms(>Q PEAK)	3.2	8.4	cfs
Warning 1: Dimension entered is not a typical dimension for inlet type specified.	Q _{PEAK} REQUIRED = 3.1	6.2	cfs

ALLOWABLE CAPACITY FOR ONE-HALF OF STREET (Minor & Major Storm)
 (Based on Regulated Criteria for Maximum Allowable Flow Depth and Spread)

Project: U-Haul Falcon
 Inlet ID: Inlet 17

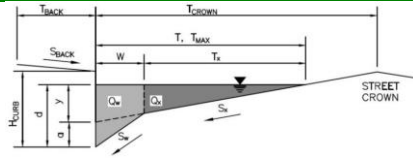

Gutter Geometry:													
Maximum Allowable Width for Spread Behind Curb	$T_{BACK} = 50.0$ ft												
Side Slope Behind Curb (leave blank for no conveyance credit behind curb)	$S_{BACK} = 0.020$ ft/ft												
Manning's Roughness Behind Curb (typically between 0.012 and 0.020)	$n_{BACK} = 0.015$												
Height of Curb at Gutter Flow Line	$H_{CURB} = 6.00$ inches												
Distance from Curb Face to Street Crown	$T_{CROWN} = 50.0$ ft												
Gutter Width	$W = 1.73$ ft												
Street Transverse Slope	$S_x = 0.020$ ft/ft												
Gutter Cross Slope (typically 2 inches over 24 inches or 0.083 ft/ft)	$S_w = 0.040$ ft/ft												
Street Longitudinal Slope - Enter 0 for sump condition	$S_o = 0.000$ ft/ft												
Manning's Roughness for Street Section (typically between 0.012 and 0.020)	$n_{STREET} = 0.015$												
Max. Allowable Spread for Minor & Major Storm	<table border="1"> <tr> <th></th> <th>Minor Storm</th> <th>Major Storm</th> <th></th> </tr> <tr> <td>T_{MAX}</td> <td>10.0</td> <td>50.0</td> <td>ft</td> </tr> <tr> <td>d_{MAX}</td> <td>6.0</td> <td>12.0</td> <td>inches</td> </tr> </table>		Minor Storm	Major Storm		T_{MAX}	10.0	50.0	ft	d_{MAX}	6.0	12.0	inches
	Minor Storm	Major Storm											
T_{MAX}	10.0	50.0	ft										
d_{MAX}	6.0	12.0	inches										
Max. Allowable Depth at Gutter Flowline for Minor & Major Storm													
Check boxes are not applicable in SUMP conditions	<input type="checkbox"/> <input type="checkbox"/>												
MINOR STORM Allowable Capacity is based on Depth Criterion													
MAJOR STORM Allowable Capacity is based on Depth Criterion													
	<table border="1"> <tr> <th></th> <th>Minor Storm</th> <th>Major Storm</th> <th></th> </tr> <tr> <td>Q_{allow}</td> <td>SUMP</td> <td>SUMP</td> <td>cfs</td> </tr> </table>		Minor Storm	Major Storm		Q_{allow}	SUMP	SUMP	cfs				
	Minor Storm	Major Storm											
Q_{allow}	SUMP	SUMP	cfs										

INLET IN A SUMP OR SAG LOCATION

MHFD-Inlet, Version 5.01 (April 2021)

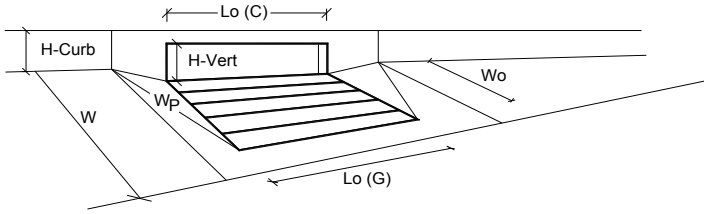

Design Information (Input)	MINOR	MAJOR	
Type of Inlet	CDOT/Denver 13 Combination		
Local Depression (additional to continuous gutter depression 'a' from above)	2.00	2.00	inches
Number of Unit Inlets (Grate or Curb Opening)	3	3	
Water Depth at Flowline (outside of local depression)	8.1	12.0	inches
Grate Information			
Length of a Unit Grate	3.00	3.00	feet
Width of a Unit Grate	1.73	1.73	feet
Area Opening Ratio for a Grate (typical values 0.15-0.90)	0.43	0.43	
Clogging Factor for a Single Grate (typical value 0.50 - 0.70)	0.50	0.50	
Grate Weir Coefficient (typical value 2.15 - 3.60)	3.30	3.30	
Grate Orifice Coefficient (typical value 0.60 - 0.80)	0.60	0.60	
Curb Opening Information			
Length of a Unit Curb Opening	3.00	3.00	feet
Height of Vertical Curb Opening in Inches	6.50	6.50	inches
Height of Curb Orifice Throat in Inches	5.25	5.25	inches
Angle of Throat (see USDCM Figure ST-5)	0.00	0.00	degrees
Side Width for Depression Pan (typically the gutter width of 2 feet)	1.00	1.00	feet
Clogging Factor for a Single Curb Opening (typical value 0.10)	0.10	0.10	
Curb Opening Weir Coefficient (typical value 2.3-3.7)	3.70	3.70	
Curb Opening Orifice Coefficient (typical value 0.60 - 0.70)	0.66	0.66	
Low Head Performance Reduction (Calculated)			
Depth for Grate Midwidth	0.724	1.049	ft
Depth for Curb Opening Weir Equation	0.61	0.93	ft
Combination Inlet Performance Reduction Factor for Long Inlets	0.76	1.00	
Curb Opening Performance Reduction Factor for Long Inlets	1.00	1.00	
Grated Inlet Performance Reduction Factor for Long Inlets	0.76	1.00	
Total Inlet Interception Capacity (assumes clogged condition)			
	Q_s = 17.3	34.8	cfs
	Q _{PEAK REQUIRED} = 17.3	32.5	cfs

Warning 1

WARNING: Inlet Capacity less than Q Peak for Minor Storm

Warning 1: Dimension entered is not a typical dimension for inlet type specified.

U-Haul at Falcon
Pipe Diameter Calculations

Pipe #	5yr Flow	100yr Flow (Design)	Contributing Flows	Manning 'n'	Pipe Slope	Calculated Pipe Diameter	Pipe Diameter	Minimum Slope of Pipe	Full Pipe Flow Velocity	Mannings Pipe Capacity	Capacity Check
S10	5.6 cfs	11.2 cfs	DP1	0.013	0.80%	19-inch	24-inch	0.25%	6.5 ft/sec	20.3 cfs	OK
S11	9.5 cfs	17.1 cfs	DP2	0.013	0.60%	24-inch	24-inch	0.57%	5.6 ft/sec	17.6 cfs	OK
S12	5.7 cfs	11.3 cfs	DP1A	0.013	0.60%	20-inch	24-inch	0.25%	5.6 ft/sec	17.6 cfs	OK
S13	14.5 cfs	28.0 cfs	DP3	0.013	0.60%	29-inch	30-inch	0.47%	6.5 ft/sec	31.9 cfs	OK
S15	2.9 cfs	5.9 cfs	DP4	0.013	0.80%	15-inch	18-inch	0.32%	5.3 ft/sec	9.4 cfs	OK
S16	3.1 cfs	6.2 cfs	DP5	0.013	0.75%	16-inch	18-inch	0.35%	5.2 ft/sec	9.1 cfs	OK
S17	2.6 cfs	4.9 cfs	J	0.013	0.80%	14-inch	18-inch	0.21%	5.3 ft/sec	9.4 cfs	OK
S20	42.6 cfs	76.2 cfs	DP24	0.013	0.75%	40-inch	42-inch	0.57%	9.1 ft/sec	87.4 cfs	OK
S21	45.0 cfs	81.1 cfs	DP25	0.013	0.81%	40-inch	42-inch	0.65%	9.4 ft/sec	90.8 cfs	OK
S22	59.5 cfs	108.1 cfs	DP26	0.013	0.60%	47-inch	48-inch	0.57%	8.9 ft/sec	111.6 cfs	OK
S23	60.9 cfs	113.7 cfs	DP27-Dev	0.013	0.80%	46-inch	48-inch	0.63%	10.3 ft/sec	128.8 cfs	OK
S24	68.3 cfs	127.9 cfs	DP28-Dev	0.013	1.00%	46-inch	48-inch	0.79%	11.5 ft/sec	144.0 cfs	OK
S30	0.4 cfs	2.6 cfs	L	0.022	1.7%	12-inch	18-inch	0.18%	4.6 ft/sec	8.1 cfs	OK
S31	2.7 cfs	11.1 cfs	DP6	0.013	1.5%	17-inch	18-inch	1.12%	7.3 ft/sec	12.9 cfs	OK

Equations:

$$\text{Pipe Dia} = ((2.16Qn)/(S^{0.5}))^{0.375}$$

Q = Discharge in cubic feet per second

n = Manning's roughness coefficient

RCP=0.013, CMP=0.024, HDPE (smooth)=0.012

S = Slope of the pipe

R_h = Hydraulic Radius

$$\text{Flow Velocity} = (1.49/n)R_h^{2/3} S^{1/2}$$

$$\text{Pipe Capacity} = (1.49/n)AR_h^{2/3} S^{1/2}$$

A = Cross-sectional area of pipe

$$A = p(D^2/4)$$

D = Inside Diameter of Pipe

$$R_h = A_w/W_p$$

$$A_w = p(d^2/4)$$

A_w = Water Cross Sectional Area

d = Water (Flow) Depth Within Pipe

W_p = pd (For Capacity Calculation)

W_p = Wetted Perimeter of Pipe

<p>Program: UDSEWER Math Model Interface 2.1.1.4</p> <p>Run Date: 9/7/2022 5:20:21 PM</p>	<h2 style="margin: 0;">UDSewer Results Summary</h2> <p>Project Title: U-Haul Falcon Main Project Description: 100-yr</p>
---	--

System Input Summary

Rainfall Parameters

Rainfall Return Period: 100
Rainfall Calculation Method: Formula

One Hour Depth (in):
Rainfall Constant "A": 28.5
Rainfall Constant "B": 10
Rainfall Constant "C": 0.786

Rational Method Constraints

Minimum Urban Runoff Coeff.: 0.20
Maximum Rural Overland Len. (ft): 500
Maximum Urban Overland Len. (ft): 300
Used UDFCD Tc. Maximum: Yes

Sizer Constraints

Minimum Sewer Size (in): 18.00
Maximum Depth to Rise Ratio: 0.90
Maximum Flow Velocity (fps): 18.0
Minimum Flow Velocity (fps): 2.0

Backwater Calculations:

Tailwater Elevation (ft): 6828.00

Manhole Input Summary:

		Given Flow		Sub Basin Information						
Element Name	Ground Elevation (ft)	Total Known Flow (cfs)	Local Contribution (cfs)	Drainage Area (Ac.)	Runoff Coefficient	5yr Coefficient	Overland Length (ft)	Overland Slope (%)	Gutter Length (ft)	Gutter Velocity (fps)
OUTFALL 1	6832.60	0.00	0.00	0.00	0.00	0.00	0.00	0.00	0.00	0.00
S24A	6840.00	127.90	0.00	0.00	0.00	0.00	0.00	0.00	0.00	0.00

S24	6839.61	127.90	0.00	0.00	0.00	0.00	0.00	0.00	0.00	0.00
S23	6840.61	113.70	0.00	0.00	0.00	0.00	0.00	0.00	0.00	0.00
S22	6846.00	108.10	0.00	0.00	0.00	0.00	0.00	0.00	0.00	0.00
S21	6847.36	81.10	0.00	0.00	0.00	0.00	0.00	0.00	0.00	0.00
S16	6847.50	6.20	0.00	0.00	0.00	0.00	0.00	0.00	0.00	0.00
S20	6850.20	76.20	0.00	0.00	0.00	0.00	0.00	0.00	0.00	0.00
E1	6851.00	70.90	0.00	0.00	0.00	0.00	0.00	0.00	0.00	0.00
S15	6848.40	5.90	0.00	0.00	0.00	0.00	0.00	0.00	0.00	0.00
S13	6847.72	28.00	0.00	0.00	0.00	0.00	0.00	0.00	0.00	0.00
S11	6845.75	17.10	0.00	0.00	0.00	0.00	0.00	0.00	0.00	0.00
S12	6848.33	11.30	0.00	0.00	0.00	0.00	0.00	0.00	0.00	0.00
S10A	6847.73	11.20	0.00	0.00	0.00	0.00	0.00	0.00	0.00	0.00
S10	6848.00	11.20	0.00	0.00	0.00	0.00	0.00	0.00	0.00	0.00
S17	6846.50	4.90	0.00	0.00	0.00	0.00	0.00	0.00	0.00	0.00
S30	6840.20	6.80	0.00	0.00	0.00	0.00	0.00	0.00	0.00	0.00
S31	6838.50	17.90	0.00	0.00	0.00	0.00	0.00	0.00	0.00	0.00

Manhole Output Summary:

Element Name	Local Contribution					Total Design Flow				Comment
	Overland Time (min)	Gutter Time (min)	Basin Tc (min)	Intensity (in/hr)	Local Contrib (cfs)	Coeff. Area	Intensity (in/hr)	Manhole Tc (min)	Peak Flow (cfs)	
OUTFALL 1	0.00	0.00	0.00	0.00	0.00	0.00	0.00	0.00	0.00	
S24A	0.00	0.00	0.00	0.00	0.00	0.00	0.00	0.00	127.90	
S24	0.00	0.00	0.00	0.00	0.00	0.00	0.00	0.00	127.90	
S23	0.00	0.00	0.00	0.00	0.00	0.00	0.00	0.00	113.70	
S22	0.00	0.00	0.00	0.00	0.00	0.00	0.00	0.00	108.10	
S21	0.00	0.00	0.00	0.00	0.00	0.00	0.00	0.00	81.10	
S16	0.00	0.00	0.00	0.00	0.00	0.00	0.00	0.00	6.20	
S20	0.00	0.00	0.00	0.00	0.00	0.00	0.00	0.00	76.20	
E1	0.00	0.00	0.00	0.00	0.00	0.00	0.00	0.00	70.90	
S15	0.00	0.00	0.00	0.00	0.00	0.00	0.00	0.00	5.90	Surface Water Present (Upstream)
S13	0.00	0.00	0.00	0.00	0.00	0.00	0.00	0.00	28.00	
S11	0.00	0.00	0.00	0.00	0.00	0.00	0.00	0.00	17.10	Surface Water Present (Upstream)
S12	0.00	0.00	0.00	0.00	0.00	0.00	0.00	0.00	11.30	
S10A	0.00	0.00	0.00	0.00	0.00	0.00	0.00	0.00	11.20	
S10	0.00	0.00	0.00	0.00	0.00	0.00	0.00	0.00	11.20	
S17	0.00	0.00	0.00	0.00	0.00	0.00	0.00	0.00	4.90	
S30	0.00	0.00	0.00	0.00	0.00	0.00	0.00	0.00	6.80	
S31	0.00	0.00	0.00	0.00	0.00	0.00	0.00	0.00	17.90	Surface Water Present (Upstream)

Sewer Input Summary:

Element Name	Sewer Length (ft)	Elevation			Loss Coefficients			Given Dimensions		
		Downstream Invert (ft)	Slope (%)	Upstream Invert (ft)	Mannings n	Bend Loss	Lateral Loss	Cross Section	Rise (ft or in)	Span (ft or in)
S24A	116.42	6827.60	2.1	6830.00	0.013	0.03	1.00	CIRCULAR	48.00 in	48.00 in
S24	121.78	6830.20	1.9	6832.50	0.013	0.14	1.00	CIRCULAR	48.00 in	48.00 in
S23	121.14	6833.00	1.1	6834.30	0.013	0.05	0.25	CIRCULAR	48.00 in	48.00 in
S22	438.12	6834.50	0.8	6837.90	0.015	0.30	0.30	CIRCULAR	48.00 in	48.00 in
S21	237.58	6838.97	1.1	6841.58	0.013	0.05	0.25	CIRCULAR	42.00 in	42.00 in
S16	13.00	6843.18	1.5	6843.38	0.013	1.00	0.00	CIRCULAR	18.00 in	18.00 in
S20	123.08	6841.58	0.7	6842.50	0.013	0.05	0.25	CIRCULAR	42.00 in	42.00 in
E1	7.67	6843.98	0.4	6844.01	0.013	0.14	0.26	CIRCULAR	42.00 in	42.00 in
S15	22.00	6845.50	5.0	6846.60	0.013	0.29	0.00	CIRCULAR	18.00 in	18.00 in
S13	119.34	6839.90	0.7	6840.70	0.013	0.82	0.00	CIRCULAR	30.00 in	30.00 in
S11	186.45	6840.90	0.5	6841.90	0.013	0.26	0.00	CIRCULAR	24.00 in	24.00 in
S12	259.38	6840.90	0.6	6842.50	0.013	0.18	0.29	CIRCULAR	24.00 in	24.00 in
S10A	73.14	6842.70	1.5	6843.80	0.013	0.05	1.00	CIRCULAR	24.00 in	24.00 in
S10	131.43	6844.03	1.5	6846.00	0.013	1.00	1.00	CIRCULAR	24.00 in	24.00 in
S17	10.00	6840.90	1.0	6841.00	0.013	1.00	0.00	CIRCULAR	18.00 in	18.00 in
S30	20.00	6837.00	8.5	6838.70	0.015	1.00	0.00	CIRCULAR	18.00 in	18.00 in
S31	42.20	6835.00	4.7	6837.00	0.015	0.44	0.00	CIRCULAR	18.00 in	18.00 in

Sewer Flow Summary:

Element Name	Full Flow Capacity		Critical Flow		Normal Flow				Flow (cfs)	Surcharged Length (ft)	Comment
	Flow (cfs)	Velocity (fps)	Depth (in)	Velocity (fps)	Depth (in)	Velocity (fps)	Froude Number	Flow Condition			
S24A	206.79	16.46	40.66	11.27	27.31	17.32	2.24	Supercritical	127.90	0.00	
S24	197.93	15.75	40.66	11.27	28.08	16.75	2.12	Supercritical	127.90	0.00	
S23	149.19	11.87	38.63	10.49	31.36	13.07	1.52	Pressurized	113.70	121.14	
S22	109.96	8.75	37.74	10.20	38.63	9.97	0.95	Pressurized	108.10	438.12	
S21	105.80	11.00	33.74	9.79	27.56	12.12	1.51	Pressurized	81.10	237.58	
S16	12.90	7.30	11.55	5.18	8.79	7.23	1.68	Pressurized	6.20	13.00	
S20	87.21	9.06	32.77	9.46	30.40	10.22	1.17	Pressurized	76.20	123.08	
E1	63.80	6.63	42.00	7.37	42.00	7.37	0.00	Pressurized	70.90	7.67	
S15	23.55	13.33	11.25	5.08	6.14	11.09	3.19	Pressurized	5.90	22.00	
S13	33.68	6.86	21.65	7.38	20.89	7.67	1.07	Pressurized	28.00	119.34	
S11	16.61	5.29	24.00	5.44	24.00	5.44	0.00	Pressurized	17.10	186.45	
S12	17.82	5.67	14.47	5.71	13.88	6.00	1.08	Pressurized	11.30	259.38	
S10A	27.78	8.84	14.41	5.69	10.60	8.37	1.80	Pressurized	11.20	73.14	

S10	27.78	8.84	14.41	5.69	10.60	8.37	1.80	Supercritical Jump	11.20	62.39	
S17	10.53	5.96	10.21	4.73	8.63	5.85	1.38	Pressurized	4.90	10.00	
S30	26.61	15.06	12.11	5.38	6.20	12.60	3.61	Supercritical Jump	6.80	18.49	
S31	19.87	11.25	17.40	10.23	13.36	12.73	2.17	Pressurized	17.90	42.20	

- A Froude number of 0 indicates that pressured flow occurs (adverse slope or undersized pipe).
- If the sewer is not pressurized, full flow represents the maximum gravity flow in the sewer.
- If the sewer is pressurized, full flow represents the pressurized flow conditions.

Sewer Sizing Summary:

Element Name	Peak Flow (cfs)	Cross Section	Existing		Calculated		Used			Comment
			Rise	Span	Rise	Span	Rise	Span	Area (ft ²)	
S24A	127.90	CIRCULAR	48.00 in	48.00 in	42.00 in	42.00 in	48.00 in	48.00 in	12.57	
S24	127.90	CIRCULAR	48.00 in	48.00 in	42.00 in	42.00 in	48.00 in	48.00 in	12.57	
S23	113.70	CIRCULAR	48.00 in	48.00 in	48.00 in	48.00 in	48.00 in	48.00 in	12.57	
S22	108.10	CIRCULAR	48.00 in	48.00 in	48.00 in	48.00 in	48.00 in	48.00 in	12.57	
S21	81.10	CIRCULAR	42.00 in	42.00 in	42.00 in	42.00 in	42.00 in	42.00 in	9.62	
S16	6.20	CIRCULAR	18.00 in	18.00 in	18.00 in	18.00 in	18.00 in	18.00 in	1.77	
S20	76.20	CIRCULAR	42.00 in	42.00 in	42.00 in	42.00 in	42.00 in	42.00 in	9.62	
E1	70.90	CIRCULAR	42.00 in	42.00 in	48.00 in	48.00 in	42.00 in	42.00 in	9.62	Existing height is smaller than the suggested height. Existing width is smaller than the suggested width. Exceeds max. Depth/Rise
S15	5.90	CIRCULAR	18.00 in	18.00 in	18.00 in	18.00 in	18.00 in	18.00 in	1.77	
S13	28.00	CIRCULAR	30.00 in	30.00 in	30.00 in	30.00 in	30.00 in	30.00 in	4.91	
S11	17.10	CIRCULAR	24.00 in	24.00 in	27.00 in	27.00 in	24.00 in	24.00 in	3.14	Existing height is smaller than the suggested height. Existing width is smaller than the suggested width. Exceeds max. Depth/Rise
S12	11.30	CIRCULAR	24.00 in	24.00 in	21.00 in	21.00 in	24.00 in	24.00 in	3.14	
S10A	11.20	CIRCULAR	24.00 in	24.00 in	18.00 in	18.00 in	24.00 in	24.00 in	3.14	
S10	11.20	CIRCULAR	24.00 in	24.00 in	18.00 in	18.00 in	24.00 in	24.00 in	3.14	
S17	4.90	CIRCULAR	18.00 in	18.00 in	18.00 in	18.00 in	18.00 in	18.00 in	1.77	
S30	6.80	CIRCULAR	18.00 in	18.00 in	18.00 in	18.00 in	18.00 in	18.00 in	1.77	
S31	17.90	CIRCULAR	18.00 in	18.00 in	18.00 in	18.00 in	18.00 in	18.00 in	1.77	

- Calculated diameter was determined by sewer hydraulic capacity rounded up to the nearest commercially available size.
- Sewer sizes should not decrease downstream.
- All hydraulics were calculated using the 'Used' parameters.

Grade Line Summary:

Tailwater Elevation (ft): 6828.00

Element Name	Invert Elev.		Downstream Manhole Losses		HGL		EGL		
	Downstream (ft)	Upstream (ft)	Bend Loss (ft)	Lateral Loss (ft)	Downstream (ft)	Upstream (ft)	Downstream (ft)	Friction Loss (ft)	Upstream (ft)
S24A	6827.60	6830.00	0.00	0.00	6829.88	6833.39	6834.54	0.82	6835.36
S24	6830.20	6832.50	0.23	0.00	6833.61	6835.89	6836.89	0.96	6837.86
S23	6833.00	6834.30	0.06	1.29	6837.94	6838.70	6839.21	0.75	6839.97
S22	6834.50	6837.90	0.34	0.93	6840.09	6843.38	6841.24	3.29	6844.53
S21	6838.97	6841.58	0.06	0.87	6844.35	6845.89	6845.45	1.54	6846.99
S16	6843.18	6843.38	0.19	0.00	6846.99	6847.04	6847.18	0.05	6847.23
S20	6841.58	6842.50	0.05	0.86	6846.92	6847.63	6847.90	0.70	6848.60
E1	6843.98	6844.01	0.12	0.75	6848.63	6848.67	6849.47	0.04	6849.51
S15	6845.50	6846.60	0.05	0.00	6848.48	6848.55	6848.65	0.07	6848.72
S13	6839.90	6840.70	0.41	0.00	6844.44	6844.99	6844.94	0.55	6845.49
S11	6840.90	6841.90	0.12	0.00	6845.15	6846.21	6845.61	1.06	6846.67
S12	6840.90	6842.50	0.04	0.45	6845.78	6846.42	6845.98	0.64	6846.62
S10A	6842.70	6843.80	0.01	0.00	6846.44	6846.61	6846.63	0.18	6846.81
S10	6844.03	6846.00	0.20	0.00	6846.81	6847.20	6847.01	0.69	6847.70
S17	6840.90	6841.00	0.12	0.00	6844.53	6844.55	6844.65	0.02	6844.67
S30	6837.00	6838.70	0.23	0.00	6839.97	6840.04	6840.20	0.10	6840.30
S31	6835.00	6837.00	0.70	0.00	6836.97	6838.59	6838.56	1.62	6840.18

- Bend and Lateral losses only apply when there is an outgoing sewer. The system outfall, sewer #0, is not considered a sewer.
- Bend loss = Bend K * V_{fi} ^ 2/(2*g)
- Lateral loss = V_{fo} ^ 2/(2*g)- Junction Loss K * V_{fi} ^ 2/(2*g).
- Friction loss is always Upstream EGL - Downstream EGL.

Excavation Estimate:

The trench side slope is 1.0 ft/ft

The minimum trench width is 2.00 ft

Element Name	Length (ft)	Wall (in)	Bedding (in)	Bottom Width (ft)	Downstream			Upstream			Volume (cu. yd)	Comment
					Top Width (ft)	Trench Depth (ft)	Cover (ft)	Top Width (ft)	Trench Depth (ft)	Cover (ft)		
S24A	116.42	5.00	6.00	7.83	0.00	5.92	0.58	17.00	10.92	5.58	319.72	Sewer Too Shallow
S24	121.78	5.00	6.00	7.83	16.60	10.72	5.38	11.22	8.03	2.69	380.90	
S23	121.14	5.00	6.00	7.83	10.22	7.53	2.19	9.62	7.23	1.89	264.24	Sewer Too Shallow
S22	438.12	5.00	6.00	7.83	9.22	7.03	1.69	13.20	9.02	3.68	1081.94	Sewer Too Shallow
S21	237.58	4.50	6.00	7.25	11.57	7.91	3.16	9.06	6.66	1.91	488.63	Sewer Too Shallow

S16	13.00	2.50	4.00	4.92	7.86	4.72	2.47	7.75	4.67	2.42	12.12	
S20	123.08	4.50	6.00	7.25	9.06	6.65	1.90	12.90	8.58	3.83	271.73	Sewer Too Shallow
E1	7.67	4.50	6.00	7.25	9.94	7.10	2.35	11.48	7.87	3.12	16.30	
S15	22.00	2.50	4.00	4.92	8.90	5.24	2.99	4.92	2.34	0.09	16.62	Sewer Too Shallow
S13	119.34	3.50	6.00	6.08	10.70	6.89	3.31	12.54	7.81	4.23	232.49	
S11	186.45	3.00	4.00	5.50	12.64	7.40	4.57	6.70	4.43	1.60	270.03	Sewer Too Shallow
S12	259.38	3.00	4.00	5.50	12.64	7.40	4.57	10.66	6.41	3.58	458.21	
S10A	73.14	3.00	4.00	5.50	10.25	6.21	3.38	6.86	4.51	1.68	88.17	Sewer Too Shallow
S10	131.43	3.00	4.00	5.50	6.40	4.28	1.45	5.50	2.58	0.00	92.44	Sewer Too Shallow
S17	10.00	2.50	4.00	4.92	9.70	5.64	3.39	10.50	6.04	3.79	13.14	
S30	20.00	2.50	4.00	4.92	6.72	4.15	1.90	4.92	2.04	0.00	11.58	Sewer Too Shallow
S31	42.20	2.50	4.00	4.92	8.72	5.15	2.90	4.92	2.04	0.00	30.46	Sewer Too Shallow

Total earth volume for sewer trenches = 4049 cubic yards.

- The trench was estimated to have a bottom width equal to the outer pipe diameter plus 36 inches.
- If the calculated width of the trench bottom is less than the minimum acceptable width, the minimum acceptable width was used.
- The sewer wall thickness is equal to: $(\text{equivalent diameter in inches}/12)+1$ inches
- The sewer bedding thickness is equal to:
 - Four inches for pipes less than 33 inches.
 - Six inches for pipes less than 60 inches.
 - Eight inches for all larger sizes.

Storm A

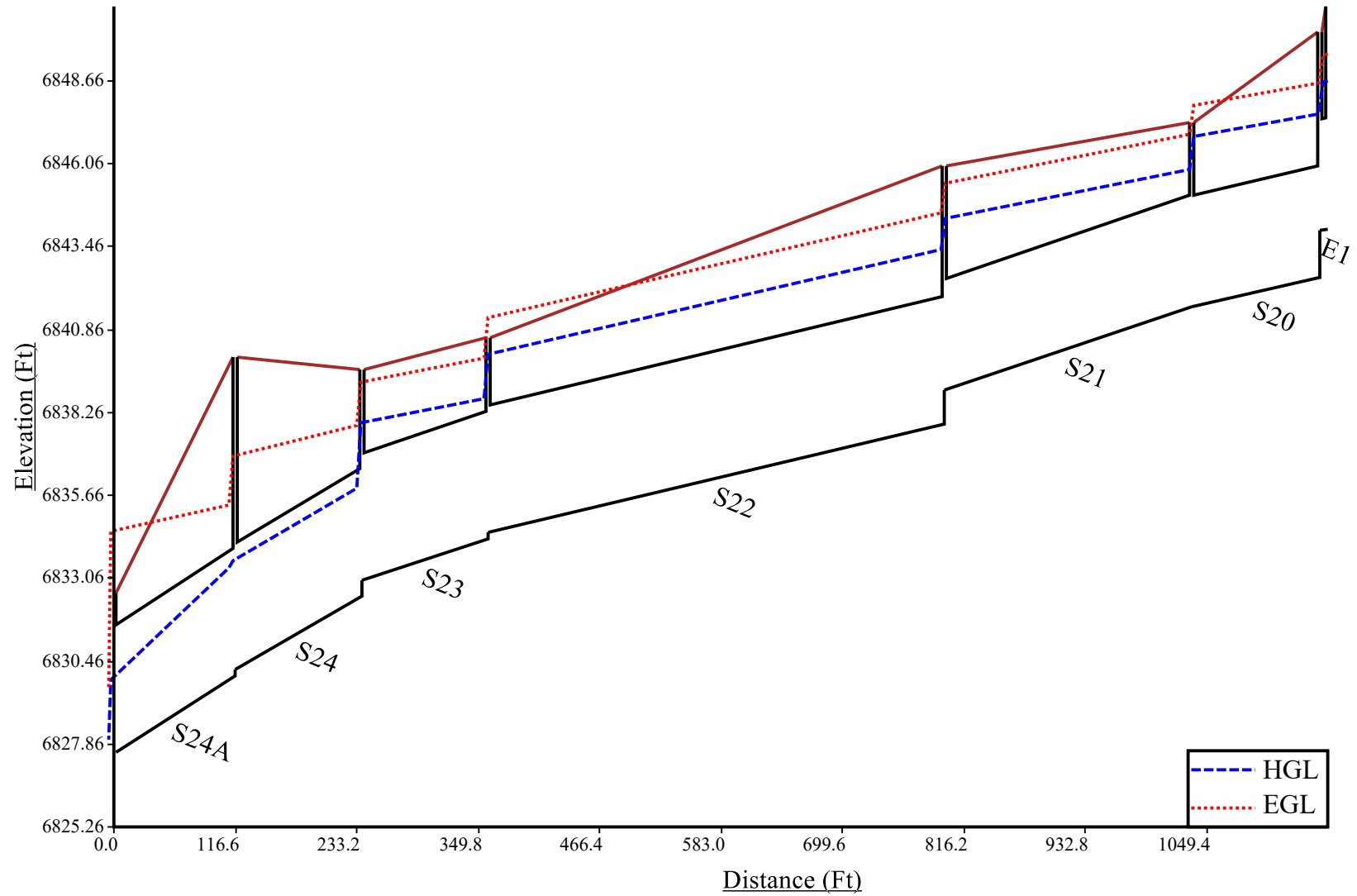

Storm B

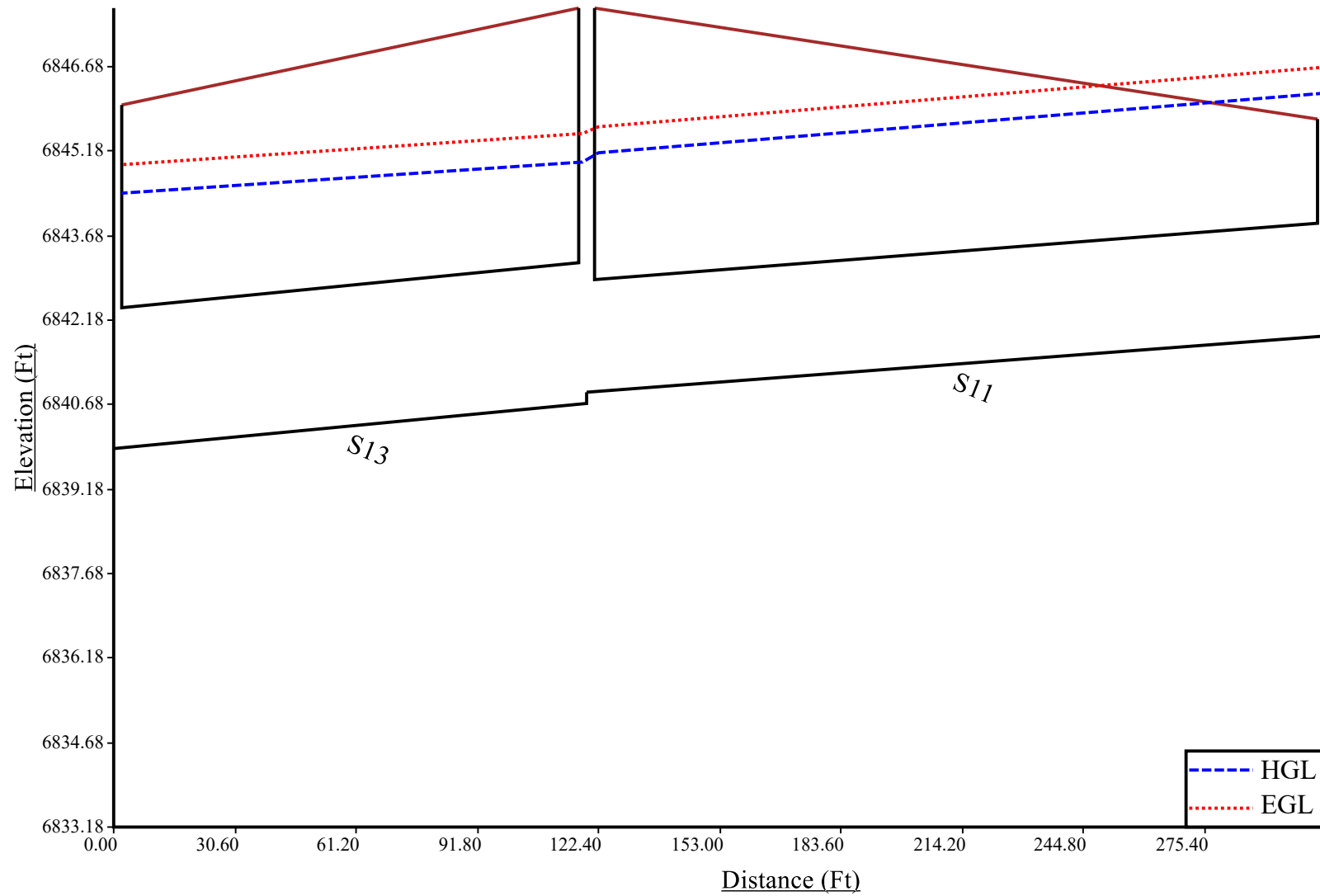

Storm C

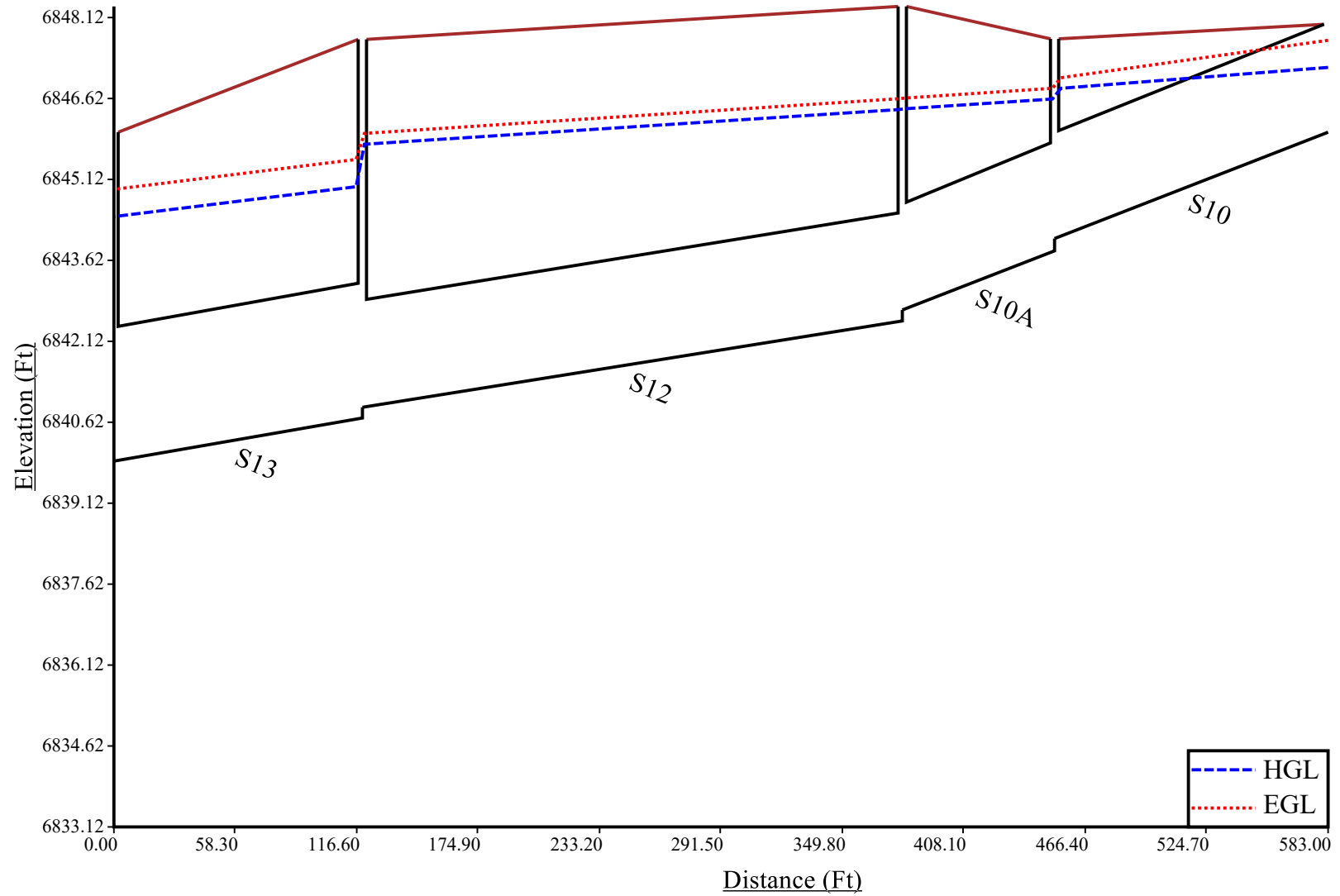

CULVERT SIZING (INLET vs. OUTLET CONTROL WITH TAILWATER EFFECTS)

MHFD-Culvert, Version 4.00 (May 2020)

Project: U-Haul Falcon

ID: Pipe S10 (DP 1) (Q100=11.2cfs)

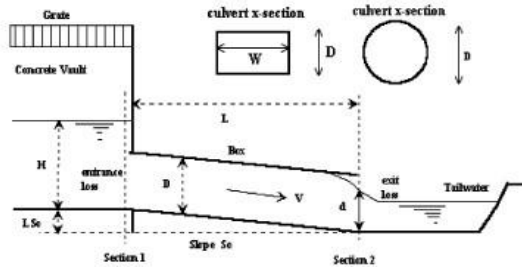

Design Information (Input):

Circular Culvert: Barrel Diameter in Inches Inlet Edge Type (Choose from pull-down list)	D = <input type="text" value="24"/> inches Grooved Edge Projecting
OR:	
Box Culvert: Barrel Height (Rise) in Feet Barrel Width (Span) in Feet Inlet Edge Type (Choose from pull-down list)	H (Rise) = <input type="text"/> ft W (Span) = <input type="text"/> ft
Number of Barrels Inlet Elevation at Culvert Invert Outlet Elevation OR Slope Culvert Length Manning's Roughness Bend Loss Coefficient Exit Loss Coefficient	# Barrels = <input type="text" value="1"/> Elev IN = <input type="text" value="100"/> ft So = <input type="text" value="0.005"/> ft/ft L = <input type="text" value="150"/> ft n = <input type="text" value="0.012"/> Kb = <input type="text" value="0"/> Kx = <input type="text" value="1"/>

Design Information (calculated):

Entrance Loss Coefficient	Ke = <input type="text" value="0.20"/>
Friction Loss Coefficient	Kf = <input type="text" value="1.58"/>
Sum of All Loss Coefficients	Ks = <input type="text" value="2.78"/>
Minimum Energy Condition Coefficient	KElow = <input type="text" value="-0.0028"/>
Orifice Inlet Condition Coefficient	Cd = <input type="text" value="0.67"/>

Calculations of Culvert Capacity (output):

Headwater Surface Elevation (ft)	Tailwater Surface Elevation (ft)	Inlet Control Equation Used	Inlet Control Flowrate (cfs)	Outlet Control Flowrate (cfs)	Controlling Culvert Flowrate (cfs)	Flow Control Used
101.50	101.00	Regression Eqn.	8.64	10.70	8.64	INLET
101.60	101.00	Regression Eqn.	9.71	11.72	9.71	INLET
101.70	101.00	Regression Eqn.	10.74	12.66	10.74	INLET
101.80	101.00	Regression Eqn.	11.82	13.53	11.82	INLET
101.90	101.00	Regression Eqn.	12.91	14.35	12.91	INLET
102.00	101.00	Regression Eqn.	13.97	15.13	13.97	INLET
102.10	101.00	Regression Eqn.	15.01	15.87	15.01	INLET
102.20	101.00	Regression Eqn.	16.01	16.58	16.01	INLET
102.30	101.00	Regression Eqn.	16.94	17.25	16.94	INLET
102.40	101.00	Regression Eqn.	17.85	17.83	17.83	OUTLET
102.50	101.00	Regression Eqn.	18.71	18.40	18.40	OUTLET

Processing Time: **01.34 Seconds**

APPENDIX D

Pages from Relevant Previous Studies
Falcon Highlands Market Place Flg No. 1 FDR
Market Place Flg No. 2 Final Drainage Letter
Bent Grass Development MDDP & DBPS Amendment
Falcon Drainage Basin Planning Study

FALCON HIGHLANDS
MARKET PLACE FILING NO. 1
PRELIMINARY AND
FINAL DRAINAGE REPORT
EL PASO COUNTY, COLORADO

December 22, 2005

PREPARED FOR:

Falcon Highlands Metropolitan District
24 N. Tejon St
Colorado Springs, CO 80903

And

Regency Centers
1873 South Bellaire St, Suite 600
Denver, CO 80222

PREPARED BY:

URS

9960 Federal Drive, Suite 300
Colorado Springs, CO 80921
719.531.0001

URS PROJECT NO. 21711426

- Basin D-28 (0.47 acres) is the south half of Rolling Thunder Way between Foxtail Meadow Lane and the West Tributary Channel. Curb and gutter conveys this flow to an existing sump inlet on Rolling Thunder Way at the West Tributary Channel. An at-grade inlet will be installed to intercept a portion of these flows. The flow-by will continue to the existing sump inlet in Rolling Thunder Way via curb and gutter. From the Falcon Highlands MDDP/FDR, the existing inlet was designed to intercept 4.8 cfs and 8.2 cfs for the 5-year and 100-year storms from this basin. Basin D-28 generates 1.7 cfs and 3.2 cfs for the 5-year and 100-year storms. The existing inlet is adequately sized for these flows.

U-Haul Site

- Basin D-29 (11.14 acres) is a proposed commercial development south of the proposed Rolling Thunder Way and between Meridian Road and the West Tributary Channel. Runoff in this basin flows towards the south and discharges directly into the West Tributary Channel upstream of Tamlin Road and detention pond WU. This basin generates 28.4 cfs and 53.4 cfs for the 5-year and 100-year storms.
- Basin D-30 (9.41 acres) consists of an undeveloped native area just east and south of the Falcon Highlands detention pond (Pond WU). Runoff from this basin combines with flows from design point 18 and the detention pond outlet and crosses under US Highway 24 through existing culverts at design point 25. Basin D-30 generates 12.1 cfs and 27.8 cfs for the 5-year and 100-year storms.
- Basin Offsite (13.96 acres) consists of an area north east of existing Meridian and McLaughlin Roads in the "Town of Falcon". The flow from this basin will be directed towards the intersection of SH 24 and Meridian Road, where it is then conveyed under an existing culvert under "old" Meridian Road. This flow will be directed towards the proposed structure at Design Point 17. The basin generates 16.4 cfs and 37.5 cfs for the 5-year and 100-year storms.

Design Point Discussion

- Design Point 1 ($Q_5=7.1$ cfs, $Q_{100}=13.2$ cfs) includes Basin D-1. This flow will be intercepted by a sump inlet, which connects directly to the 8x8 rcbc parallel to Meridian Road. This inlet will be included in the internal plans for the commercial development.
- Design Point 2 ($Q_5=6.8$ cfs, $Q_{100}=12.6$ cfs) includes Basin D-2. A 15' at-grade inlet, to keep flows from entering the Beckett at Woodmen Hills Filing No. 3 site, intercepts flow at this design point. This flow will be released directly into detention pond MN.
- Design Point 3 ($Q_5=6.0$ cfs, $Q_{100}=11.1$ cfs) contains Basin D-4. This design point is a 10' sump inlet, which intercepts the curb and gutter flow. This inlet will connect with design point DP-5 through an 18" rcp.

- Design Point 5 ($Q_5=6.4$ cfs, $Q_{100}=11.7$ cfs) contains Basin D-5. This design point is a 10' sump inlet, which intercepts curb and gutter flow along the east side of Meridian Road. The outflow at this point is 22.8 cfs, the combined intercepted flows from DP-3 and DP-5. This flow is released directly into detention pond MN through an 18" rcp.
- Design Point 6 ($Q_5=9.4$ cfs, $Q_{100}=17.4$ cfs) contains Basin D-7. A 15' on-grade inlet will intercept curb and gutter flow. This design point will release through an 18" rcp into a temporary roadside ditch along the north side of Rolling Thunder Way.
- Design Point 7 ($Q_5=40.8$ cfs, $Q_{100}=76.5$ cfs) contains Basin D-16 and flow-by from Inlet DP-6. This design point collects curb and gutter flow along the east side of Meridian Road from the access point south to Rolling Thunder Way. An existing temporary culvert is located at this design point to intercept the street flow from D-7 and the sheet/channel flow from D-16 and convey the flow under the existing section of Rolling Thunder Way.
- Design Point 10 ($Q_5=9.5$ cfs, $Q_{100}=17.5$ cfs) contains Basin D-6. This design point collects the curb and gutter flow along the west side of Meridian Road, between the access point and Rolling Thunder Way. A 15' on-grade inlet will collect the majority of this flow just upstream of Rolling Thunder Way and will be piped to Design Point 21 via an 18" rcp. The by-pass flow will continue as curb and gutter flow west along Rolling Thunder Way, where the sump inlet at Design Point 21 will intercept it.
- Design Point 11 ($Q_5=38.7$ cfs, $Q_{100}=71.4$ cfs) contains Basins D-19 and D-25. This design point is a 42" rcp stub used to temporarily intercept the flow from these two basins. The stub will connect to the proposed sump inlet in Rolling Thunder Way at design point 21. Once these basins develop, an internal storm system will need to be designed to convey the developed flow.
- Design Point 13 ($Q_5=9.4$ cfs, $Q_{100}=17.2$ cfs) contains Basin D-12. This flow combines with the flow from the temporary culvert at design point 7. A temporary vegetated v-ditch conveys the flow to design point 17, until further development occurs.
- Design Point 14 ($Q_5=9.2$ cfs, $Q_{100}=17.0$ cfs) contains Basin D-11. This design point collects curb and gutter flow along the west side of Meridian Road between Rolling Thunder Way and the access point north of Highway 24. This flow will release directly into the water quality area of the West Tributary Channel.
- Design Point 15 ($Q_5=10.6$ cfs, $Q_{100}=19.6$ cfs) contains Basin D-15. This design point collects curb and gutter flow along the east side of Meridian Road between the access point north of Highway 24 to Highway 24. This flow is intercepted by a 20' sump inlet, which connects to the box culvert crossing under Meridian Road, just north of Highway 24.

- Design Point 16 ($Q_5=11.7$ cfs, $Q_{100}=21.5$ cfs) contains Basin D-14. This design point is a 25' sump inlet, which collects the street flow between an access drive and Highway 24. A 24" rcp will connect this inlet to the proposed box culvert under Meridian Road.
- Design Point 17 ($Q_5=157.9$ cfs, $Q_{100}=300.6$ cfs) combines flow from design points 7 and 13 and flow from Basin D-17 and Basin Offsite. A 12'(w) x 3' (h) reinforced concrete box will convey this flow under Meridian Road to the west, where the flow combines with the intercepted street flow from the sump inlets at design points 15 and 16.
- Design Point 18 ($Q_5=181.2$ cfs, $Q_{100}=345.5$ cfs) combines the culvert flow from design point 17 with the intercepted street flow from design points 15 and 16. At this location, a channel is graded to convey this flow to design point 25 at Highway 24, where the flow exits the Falcon Highlands development area under an existing bridge.
- Design Point 19 ($Q_5=3.6$ cfs, $Q_{100}=6.7$ cfs) is the street flow from Foxtail Meadow Lane between Woodmen Road and Shopping Center Drive. A 5' at-grade inlet intercepts 0.4 cfs for the 5 and 100-year storms. The remaining flow will continue as street flow to design point 21. The inlet flow combines with the flow from Basin D-23 and is conveyed through a 36" rcp storm system in Foxtail Meadow Lane and Rolling Thunder Way to the West Tributary Channel.
- Design Point 20 ($Q_5=74.2$ cfs, $Q_{100}=136.9$ cfs) contains Basin D-24. Currently, this flow will continue through natural drainage swales, but upon development, an internal storm system will connect to a proposed 42" rcp stub, which connects to the major storm system (8x8 box culverts) along the west side of Meridian Road.
- Design Point 21 ($Q_5=10.2$ cfs, $Q_{100}=12.3$ cfs) combines curb and gutter flow from Basins D-21 and D-26 with the street flow from design points 10 and 19. A 25' sump inlet will intercept this flow. The 100-year flow will overtop the crown and will be intercepted by the inlet at design point 22. The inlet will connect to the sump inlet at design point 22 through a 42" rcp.
- Design Point 22 ($Q_5=3.3$ cfs, $Q_{100}=6.1$ cfs) contains curb and gutter flow from Basin D-27 and 100-year overtopping flow from inlet DP-21. A 5' sump inlet intercepts the flow. A 42" rcp will continue to design point 23.
- Design Point 23 ($Q_5=39.2$ cfs, $Q_{100}=72.2$ cfs) combines the intercepted flows from design points 11, 21 and 22. A temporary 42" rcp stub will release the flow onto Basin D-29, where a temporary swale will continue to carry the flow until the channel matches existing ground. At this point, the flow will continue as sheet flow until it reaches the West Tributary Channel. Upon development of Basin D-29, an internal storm conveyance system will be designed to carry this flow, which will also release into the West Tributary Channel. The temporary stub and channel can be removed once the storm system is built.

- Design Point 25 ($Q_5=221.91$ cfs, $Q_{100}=1479.1$ cfs) combines Basin D-30 with flows from design points 14, 18 and detention pond WU. This is where the flow leaves the Falcon Highlands development via the existing bridge at Highway 24.
- Design Point 26 ($Q_5=160.9$ cfs, $Q_{100}=788.5$) combines the intercepted street flow of design points 2, 3 and 5 with the flow from design point 20 and pipe flow from off-site points MN1 and MN2. This flow is released directly into Pond MN through an 8x8 RCBC and two sets of 18" rcp's.

Proposed Storm System Improvements

All of the proposed inlets, pipes and ditches were analyzed using StormCad, Culvert Master and Flow Master programs. Calculations for the proposed culvert improvements can be found in Appendix I: Proposed Culvert Improvements.

The proposed systems will be sized to collect and convey the estimated 100-year runoff. The 8x8 RCBC's will convey flow from design points MN1 ($Q_{100}=454.0$ cfs) and MN2 ($Q_{100}=363.1$ cfs) to detention pond MN. The DBPS amendment also addresses this change from the approved Falcon Area DBPS. One 10-foot CDOT Type-R curb inlet in sump condition will be installed at DP-3 and at DP-5. An 18-inch rcp is used to connect the inlets at DP-3 and DP-5. The storm system discharges into detention pond MN with an estimated flow of 12.0 cfs for the 100-year storm.

A new 8x8 box culvert/trail crossing will be installed at station 32+50, paralleling the 8x8 storm system, and both will outfall into the detention pond east of Meridian Road. These culverts were previously designed in the CLOMR for the Middle Tributary of the Falcon Basin, prepared by URS Corporation in January 2005. This box will also serve as the conveyance system for the flow in the proposed overflow swale on top of the box storm drain system. Also, it will convey the minor surface flow not intercepted by the internal storm system in Basin D-24, which is approximately 15 cfs for the 5-year and 28 cfs for the 100-year storms.

One 10-foot CDOT Type-R curb inlet in sump conditions will be installed at DP-1. This inlet will release directly into the 8x8 RCBC along the west side of Meridian Road.

A 10-foot CDOT Type-R at-grade curb inlet will be constructed at DP-2. This inlet will intercept 4.5 cfs and 7.4 cfs for the 5 and 100-year storms. An 18" rcp will deliver these flows directly into detention pond MN.

DP-19 is a 5-foot at-grade CDOT Type-R curb inlet, which will intercept 0.4 cfs for the 5 and 100-year storms. A 36-inch rcp stub collects the flow Basin D-23 and connects to the back of the inlet. This combined flow (DP-19 and D-23) continues through a 36-inch rcp in Foxtail Meadow Lane and Rolling Thunder Way to the existing box culvert in the West Tributary Channel. This system releases approximately 49.2 cfs into the channel.

A storm drain system is designed for flows at Rolling Thunder Way. This system connects 2 sump inlets in Rolling Thunder Way. Design point 11 is a 42" rcp stub, which will be used to intercept the sheet flow from basins D-19 and D-25. Flow from design

point 10 will be directed toward the sump inlet at design point 21. Design point 23 will be a temporary outlet point for the combined flows of design points 11, 21 and 22. This flow will be conveyed through a temporary vegetated channel, west to the West Tributary Channel, through Basin D-29 until development occurs in this area.

DP-15 and DP-16 are both 20' sump inlets (CDOT Type-R), which intercepts the street flow from Meridian Road just north of Highway 24. Both inlets connect to the proposed box culvert (DP-17) under Meridian Road, via 24-inch rcp's. The proposed drainage structure at DP-17 will be a 12-foot (W) by 3-foot (H) reinforced concrete box culvert. Using the criteria stated in the DCM, the maximum allowable HW/D for this structure is 1.2, which correlates to an elevation of 6815.40. Calculations for the new pipes have been provided in Appendix I.

Channel Improvements

The overflow swale on the south side of Woodmen Road is designed to carry a flow of 605 cfs, in the event the major storm structure should fail. The swale is a 25-foot trapezoidal channel with a flow depth of 1.92 feet and a velocity of 8.6 feet per second (fps). This swale will release into the 8 x 8 trail box under Meridian Road and will be conveyed to detention pond MN.

The roadside ditch along Basin D-12 is located east of Meridian Road from the right-in access point south to Highway 24. The ditch will carry the 100-year storm (17.2 cfs) at a depth of 0.85 feet to DP-17. The velocity in this channel is 3.94 fps.

The temporary channel from DP-23 has a 100-year flow of 200 cfs from the proposed storm system. The channel will be trapezoidal with a 50-foot bottom and 4 to 1 side slopes. The velocity of the channel is 3.61 fps with a flow depth of 1.02 feet. This channel will be graded out to match existing grade. Upon development of Basin D-29, this channel will be removed and the flow will be intercepted by an internal storm system.

A temporary roadside will carry the intercepted flow from Design Point 6 to the temporary culvert under Rolling Thunder Way. The v-ditch channel will carry a flow of 17 cfs at a depth of 1.0 feet and a velocity of 3.8 ft/s.

DRAINAGE FACILITY DESIGN

General Concept

The area south of Woodmen Road, which includes the proposed Market Place site and Meridian Road, is either routed to detention pond WU in Falcon Highlands or detention pond MN, east of the realigned Meridian Road. Flow from each of these ponds continues south, crossing under US Highway 24 and Falcon Highway, until they combine at design point WX. Pond WU was designed as part of the Falcon Highlands MDDP/PDR/FDR for Filing 1 by URS dated January 21, 2005. Detention pond MN is approximately 14.0

acre-feet with a maximum water surface elevation of 6852.80. Discharge will be through 2- 8x4 RCBC, which will release into an existing channel to US Highway 24.

Detention pond WU and the West Tributary channel were designed in the MDDP/PDR/FDR for Falcon Highlands Filing No. 2. Each of these facilities were designed based on SCS HEC-1 flows. Both of these are located within the Falcon Basin West Tributary and all basins within the current development were accounted for in the MDDP/PDR/FDR design of these structures. The HEC-1 run for the West Tributary of the Falcon Basin is included in Appendix D.

Under existing conditions, there are 6 drainage basins, 5 of which contribute to the West Tributary Channel/Pond WU and the remaining basin flows towards McLaughlin Road. (See Figure 5:Existing Drainage Plan) Currently, there are no drainage structures within any of the 6 basins. Flow is conveyed through natural, vegetated swales and channels.

In the proposed conditions, 6 of the rational basins contribute to detention pond MN, with all the remaining basins releasing into the West Tributary Channel or detention pond WU. At design point MN1 and MN2, a major storm sewer system has been designed to intercept flows from the existing culverts at Woodmen Road and deliver it to Pond MN. This allows the proposed 8x8 RCBC under Meridian Road to serve as a trail crossing and to carry only the surface runoff not intercepted by the internal storm system from Basin D-24. An internal storm system is being designed, thereby decreasing the initial flows for the trail crossing at this location. Pond MN will also receive intercepted curb and gutter flow from Basins D-1, D-2, D-4 and D-5.

The remainder of Meridian Road will convey flow through curb and gutter, and minor storm systems, which eventually discharge into the West Tributary Channel at various locations. The future commercial and multi-family developments will be overlot graded so that they will drain towards the West Tributary Channel. Upon development of these areas, internal storm drain systems will need to be designed. These systems, will also release into the West Tributary Channel.

Detention Pond MN

The Falcon Basin DBPS provided the initial precipitation data, basin delineation, CN runoff coefficients and times of concentration. The original data was processed using HEC-1 software. For this report, the data was converted to the HEC-HMS software. Other than the incorrect input for Pond W, the existing HEC-HMS used the same data in the HEC-1 analysis. Only Basin D-23 changed for the proposed condition: it has been divided into 2 basins, 23A and 23B, due to the realignment of Meridian Road, and the CN value has changed from undeveloped (60) conditions to commercial (92).

It was determined that detention pond MN is approximately 14.0 acre-feet. The existing flows at this location are 63.8 cfs and 628.3 cfs for the 5-year and 100-year storms. The developed flows entering the pond are $Q_5=94.4$ cfs and $Q_{100}=646.0$ cfs (Design Point MO in the HEC-HMS analysis). With the current outlet design, Pond MN releases flows of 46.1 cfs (72% of existing) and 459.9 cfs (73% of existing) for the 5-year and 100-year storms. The current design of Pond MN differs from that in the Falcon DBPS because the location of the pond has moved. Prior, the pond was to be located on the west side of

DEVELOPED DRAINAGE PLAN - FALCON HIGHLANDS MARKET PLACE FILING NO. 1

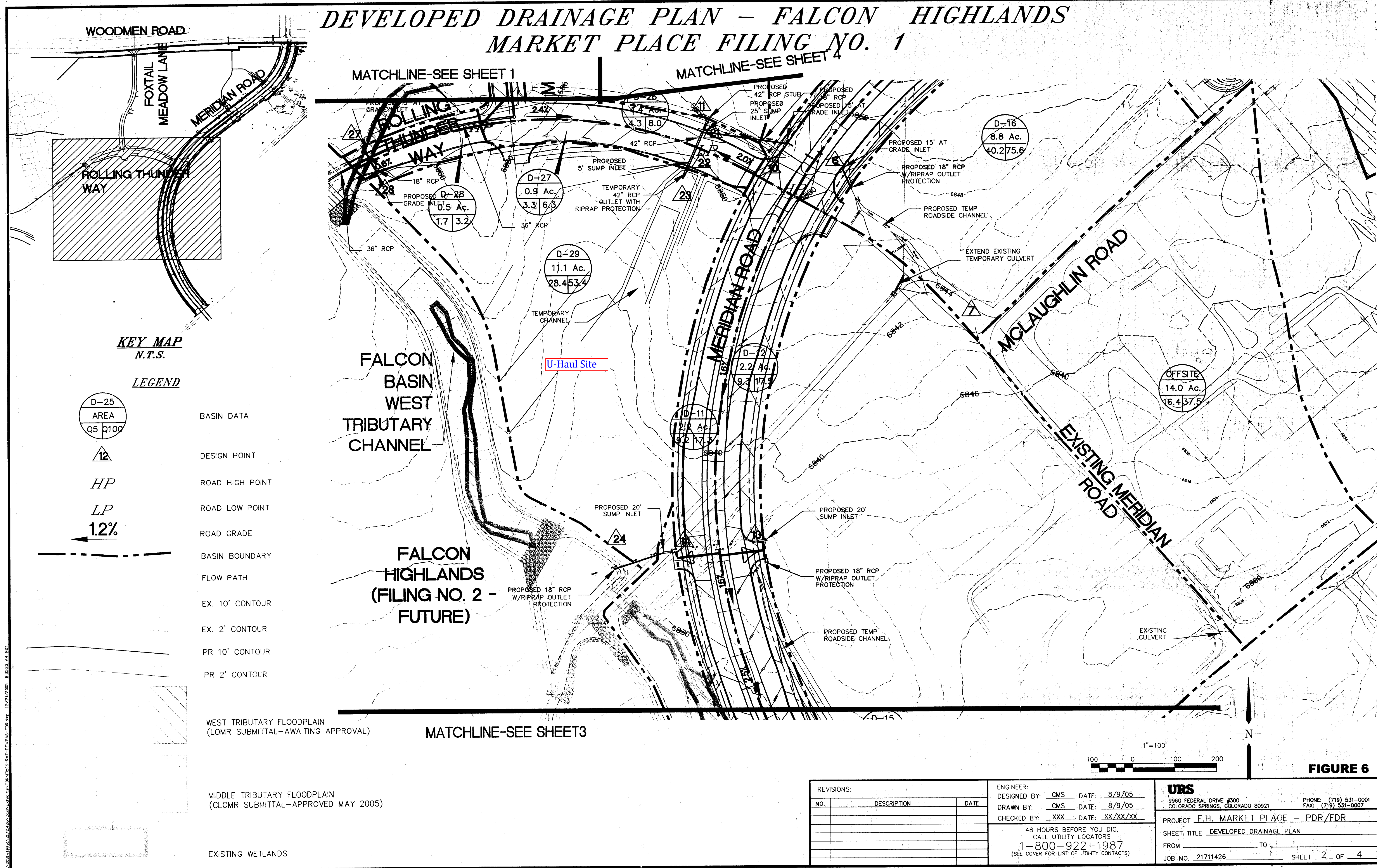

KEY MAP
N.T.S.

LEGEND

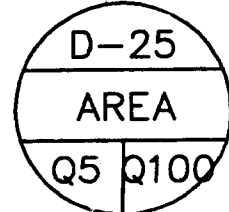

BASIN DATA



DESIGN POINT

HP

ROAD HIGH POINT

LP

ROAD LOW POINT

1.2%

ROAD GRADE

BASIN BOUNDARY

FLOW PATH

EX. 10' CONTOUR

EX. 2' CONTOUR

PR 10' CONTOUR

PR 2' CONTOUR

WEST TRIBUTARY FLOODPLAIN
(LOMR SUBMITTAL-AWAITING APPROVAL)

MIDDLE TRIBUTARY FLOODPLAIN
(CLOMR SUBMITTAL-APPROVED MAY 2005)

EXISTING WETLANDS

FIGURE 6

REVISIONS:			ENGINEER:		URS 9960 FEDERAL DRIVE #300 COLORADO SPRINGS, COLORADO 80921 PHONE: (719) 531-0001 FAX: (719) 531-0007
NO.	DESCRIPTION	DATE	DESIGNED BY:	DATE:	
			CMS	8/9/05	PROJECT F.H. MARKET PLACE - PDR/FDR SHEET TITLE DEVELOPED DRAINAGE PLAN FROM _____ TO _____ JOB NO. 21711426 SHEET 2 OF 4
			CMS	8/9/05	
			XXX	XX/XX/XX	
			48 HOURS BEFORE YOU DIG, CALL UTILITY LOCATORS 1-800-922-1987 (SEE COVER FOR LIST OF UTILITY CONTACTS)		

I:\S01\12171426\12171426\FDR\FDR-RAT-DE-04\FDR-RAT-DE-04-FDR.dwg, Layer: 02, 12/21/2005 8:39:09 AM, CP2: I:\S01\12171426\12171426\FDR-RAT-DE-04\FDR-RAT-DE-04-FDR.dwg, 12/21/2005 8:39:33 AM, KST

**MARKET PLACE FILING NO. 1- PDR & FDR - DEVELOPED CONDITIONS
(RATIONAL METHOD Q=CIA)**

BASIN	TOTAL FLOWS				AREA TOTAL (Ac)	WEIGHTED		OVERLAND				CHANNEL				Tc TOTAL (min)	INTENSITY		COMMENTS
	Q5	Q100	CA(equiv.)			Cs	C100	Cs	Length	Slope	Tco	Length	Slope	Velocity	Tcc		I5	I100	
	(c.f.s.)	(c.f.s.)	5 YR	100 YR					(ft)	(ft)	(min)	(ft)	(%)	(fps)	(min)		(in/hr)	(in/hr)	
D-1	7.0	13.2	1.38	1.45	1.53	0.90	0.95	0.90	5	2.0%	0.7	536	3.0%	3.5	2.6	5.0	5.1	9.1	
D-2	6.7	12.6	1.31	1.39	1.46	0.90	0.95	0.90	5	2.0%	0.7	624	3.0%	3.5	3.0	5.0	5.1	9.1	
D-4	5.9	11.1	1.16	1.23	1.29	0.90	0.95	0.90	5	2.0%	0.7	344	1.0%	2.0	2.9	5.0	5.1	9.1	
D-5	6.2	11.7	1.22	1.29	1.36	0.90	0.95	0.90	5	2.0%	0.7	336	1.0%	2.0	2.8	5.0	5.1	9.1	
D-6	9.5	17.8	2.02	2.13	2.24	0.90	0.95	0.90	5	2.0%	0.7	925	1.6%	2.5	6.1	6.8	4.7	8.4	
D-7	9.4	17.6	1.96	2.07	2.18	0.90	0.95	0.90	5	2.0%	0.7	867	1.6%	2.5	5.7	6.4	4.8	8.5	
D-11	9.2	17.3	1.96	2.07	2.18	0.90	0.95	0.90	5	2.0%	0.7	928	1.6%	2.5	6.1	6.8	4.7	8.3	
D-12	9.3	17.5	1.94	2.04	2.15	0.90	0.95	0.90	5	2.0%	0.7	848	1.6%	2.5	5.6	6.3	4.8	8.5	
D-14	11.6	21.7	2.36	2.49	2.62	0.90	0.95	0.90	5	2.0%	0.7	873	2.0%	2.8	5.1	5.8	4.9	8.7	
D-15	10.5	19.7	2.09	2.20	2.32	0.90	0.95	0.90	5	2.0%	0.7	797	2.0%	2.8	4.7	5.4	5.0	8.9	
D-16	40.2	75.6	7.88	8.32	8.76	0.90	0.95	0.90	10	2.0%	0.9	647	2.0%	2.8	3.8	5.0	5.1	9.1	
D-17	92.9	174.5	21.50	22.70	23.89	0.90	0.95	0.90	10	2.0%	0.9	1,315	2.0%	2.8	7.7	8.7	4.3	7.7	
D-18	3.6	6.8	0.72	0.76	0.81	0.90	0.95	0.90	35	2.0%	1.8	760	2.8%	3.3	3.8	5.5	5.0	8.8	
D-19	27.6	51.8	5.40	5.70	6.00	0.90	0.95	0.90	25	2.0%	1.5	425	2.0%	2.8	2.5	5.0	5.1	9.1	
D-20	42.9	80.7	8.43	8.90	9.37	0.90	0.95	0.90	145	5.5%	2.6	475	2.5%	3.2	2.5	5.1	5.1	9.1	
D-21	44.8	85.2	11.12	11.87	15.03	0.74	0.79	0.90	140	6.8%	2.4	1,385	2.0%	2.8	8.1	10.5	4.0	7.2	
D-22	4.1	7.7	1.15	1.22	1.28	0.90	0.95	0.25	35	2.0%	7.5	1,305	2.8%	3.3	6.6	14.0	3.6	6.3	
D-23	43.6	82.0	11.63	12.27	12.92	0.90	0.95	0.90	25	5.3%	1.1	2,100	2.4%	3.1	11.4	12.5	3.8	6.7	
D-24	74.1	139.2	15.88	16.76	17.64	0.90	0.95	0.90	105	5.7%	2.2	1,030	3.3%	3.6	4.7	6.9	4.7	8.3	
D-25	15.8	29.8	3.69	3.90	4.10	0.90	0.95	0.25	25	2.9%	5.6	550	2.0%	2.8	3.2	8.8	4.3	7.6	
D-26	4.3	8.0	1.28	1.35	1.42	0.90	0.95	0.25	35	2.0%	7.5	1,735	2.8%	3.3	8.7	16.2	3.3	5.9	
D-27	3.3	6.3	0.77	0.82	0.86	0.90	0.95	0.25	25	2.0%	6.3	440	2.4%	3.1	2.3	8.7	4.3	7.7	
D-28	1.7	3.2	0.42	0.45	0.47	0.90	0.95	0.25	25	2.0%	6.3	360	0.6%	1.5	3.9	10.2	4.1	7.2	
D-29	28.4	53.4	10.03	10.58	11.14	0.90	0.95	0.25	230	3.5%	16.0	955	1.5%	2.4	6.6	22.5	2.8	5.0	
D-30	12.1	27.8	3.29	4.23	9.41	0.35	0.45	0.25	60	10.0%	5.8	1,020	1.4%	2.3	7.3	13.0	3.7	6.6	
D-31	0.5	1.2	0.11	0.14	0.32	0.35	0.45	0.25	10	2.0%	4.0	285	0.6%	1.5	3.1	7.1	4.6	8.2	
OFFSITE	16.4	37.5	4.89	6.28	13.96	0.35	0.45	0.25	20	2.0%	5.7	1,370	1.2%	2.2	10.4	16.1	3.4	6.0	
Formula:	C*I*A	C*I*A	Q/I	Q/I	156.71					*1				*2	*3	Tco+Tcc	*4	*6	
														20			1.5	2.67	

- 1* $Tco = 1.87 * (1.1 - C5) * (L^{0.5}) * ((S * 100)^{-0.33})$ (DCM page 5-11)
- 2* $Vc = 20 * S^{0.5}$ (USDCM RO-4)
- 3* $Tcc = 1/V * L/60$
- 4* $I5 = (26.65 * 1.50) / (10 + Tc)^{0.76}$ (City Letter of 1/7/2003)
- 6* $I100 = (26.65 * 2.67) / (10 + Tc)^{0.76}$ (City Letter of 1/7/2003)

MARKET PLACE FILING NO. 1- PDR & FDR - DEVELOPED CONDITIONS

SURFACE ROUTING

DESIGN POINT	CONTRIBUTING BASINS	CA (equivalent)		Tc (min.)	INTENSITY		TOTAL FLOWS		
		CA(5)	CA(100)		I(5) (in/hr)	I(100) (in/hr)	Q(5) (cfs)	Q(100) (cfs)	
1	D-1	1.38	1.45	5.0	5.2	9.1	7.1	13.2	
		TRAVEL TIME							
		1.38	1.45	Type/flow	Length (ft)	Velocity (fps)	d. Time (min)	T. Time (min)	
					2.9	0.0	5.0		
2	D-2	1.31	1.39	5.0	5.2	9.1	6.8	12.6	
		TRAVEL TIME							
		1.31	1.39	Type/flow	Length (ft)	Velocity (fps)	d. Time (min)	T. Time (min)	
					2.8	0.0	5.0		
3	D-4	1.16	1.23	5.0	5.2	9.1	6.0	11.1	
		TRAVEL TIME							
		1.16	1.23	Type/flow	Length (ft)	Velocity (fps)	d. Time (min)	T. Time (min)	
			83		3.3	0.4	5.4		
5	D-5	1.22	1.29	5.0	5.2	9.1	6.4	11.7	
		TRAVEL TIME							
		1.22	1.29	Type/flow	Length (ft)	Velocity (fps)	d. Time (min)	T. Time (min)	
					4.5	0.0	5.0		
6	D-7	1.96	2.07	6.4	4.8	8.4	9.4	17.4	
		TRAVEL TIME							
		1.96	2.07	Type/flow	Length (ft)	Velocity (fps)	d. Time (min)	T. Time (min)	
					4.5	0.0	6.4		
7	DP-6 (INLET) D-16	0.62	0.80	6.4	4.8	8.4	40.8	76.5	
		7.88	8.32	TRAVEL TIME					
		8.51	9.12	Type/flow	Length (ft)	Velocity (fps)	d. Time (min)	T. Time (min)	
			77		4.7	0.3	6.7		
10	D-6	2.02	2.13	6.8	4.7	8.2	9.5	17.5	
		TRAVEL TIME							
		2.02	2.13	Type/flow	Length (ft)	Velocity (fps)	d. Time (min)	T. Time (min)	
			83		5.8	0.2	7.0		
11	D-19 D-25	5.40	5.70	8.8	4.3	7.4	38.7	71.3	
		3.69	3.90	TRAVEL TIME					
		9.09	9.60	Type/flow	Length (ft)	Velocity (fps)	d. Time (min)	T. Time (min)	
					0.0	0.0	8.8		
13	D-12	1.94	2.04	6.3	4.8	8.4	9.4	17.2	
		TRAVEL TIME							
		1.94	2.04	Type/flow	Length (ft)	Velocity (fps)	d. Time (min)	T. Time (min)	
			98		6.1	0.3	6.5		

DP 11: D19, D25 = 10.1 acres

Entrance to Ex. 42" RCP at NE corner site under Rolling Thunder

DESIGN POINT	CONTRIBUTING BASINS	CA (equivalent)		Tc (min.)	INTENSITY		TOTAL FLOWS		
		CA(5)	CA(100)		I(5) (in/hr)	I(100) (in/hr)	Q(5) (cfs)	Q(100) (cfs)	
14	D-11	1.96	2.07	6.8	4.7	8.2	9.2	17.0	
		TRAVEL TIME							
		1.96	2.07	Type/flow	Length (ft)	Velocity (fps)	d. Time (min)	T. Time (min)	6.8
15	D-15	2.09	2.20	5.4	5.1	8.9	10.6	19.6	
		TRAVEL TIME							
		2.09	2.20	Type/flow	Length (ft)	Velocity (fps)	d. Time (min)	T. Time (min)	8.3
16	D-14	2.36	2.49	5.8	5.0	8.6	11.7	21.5	
		TRAVEL TIME							
		2.36	2.49	Type/flow	Length (ft)	Velocity (fps)	d. Time (min)	T. Time (min)	5.9
17	DP-7 DP-13 D-17 OFFSITE	8.51	9.12	8.7	4.3	7.5	157.9	300.6	
		1.94	2.04						
		21.50	22.70						
		4.89	6.28						
18	DP-17 DP-15 (INLET) DP-16 (INLET)	36.83	40.14	5.9	4.9	8.6	181.2	345.5	
		0.00	0.07						
		0.00	0.00						
		36.83	40.21	Type/flow	Length (ft)	Velocity (fps)	d. Time (min)	T. Time (min)	6.2
19	D-18	0.72	0.76	5.5	5.0	8.8	3.6	6.7	
		TRAVEL TIME							
		0.72	0.76	Type/flow	Length (ft)	Velocity (fps)	d. Time (min)	T. Time (min)	5.7
20	D-24	15.88	16.76	6.9	4.7	8.2	74.2	136.9	
		TRAVEL TIME							
		15.88	16.76	Type/flow	Length (ft)	Velocity (fps)	d. Time (min)	T. Time (min)	7.2
21	D-26 DP-10 (INLET) D-22 DP-19 (INLET)	1.28	1.35	16.2	3.2	5.7	10.2	12.3	
		0.64 ✓	0.82 ✓						
		1.15	1.22						
		0.06 ✓	0.04 ✓						
22	D-27 DP 21 (INLET)	0.77	0.82	8.7	4.3	7.5	3.3	6.1	
		3.13	0.00	3.43	0.00	TRAVEL TIME			
		3.90	0.77	4.25	0.82	Type/flow	Length (ft)	Velocity (fps)	d. Time (min)

DESIGN POINT	CONTRIBUTING BASINS	CA (equivalent)		Tc (min.)	INTENSITY		TOTAL FLOWS		
		CA(5)	CA(100)		I(5) (in/hr)	I(100) (in/hr)	Q(5) (cfs)	Q(100) (cfs)	
DP 23: D19, D25, D27, D26, D22, D6, D18 = 16.71 acres									
23	DP-11	9.09	9.60	10.5	4.0	6.9	39.2	72.2	
	DP-22 (INLET)	0.77	0.82						
	TRAVEL TIME								
		9.86	10.41	Type/flow	Length (ft)	Velocity (fps)	d. Time (min)	T. Time (min)	
	16.71 ac x 0.90=15.04	16.71 ac x 0.95=15.87		139	8.4	0.3			
25	DP-18	36.83	40.21	13.0	3.6	6.3	221.9	1479.1	
	POND WU	19.44	188.25						
	DP-14	1.96	2.07						
	D-30	3.29	4.23						
	TRAVEL TIME								
	61.53	234.76	Type/flow	Length (ft)	Velocity (fps)	d. Time (min)	T. Time (min)		
				83	5.8	0.2	13.3		
26	DP-3 (INLET)	0.00	0.02	7.2	4.6	8.1	160.9	788.5	
	DP-5 (INLET)	0.00	0.09						
	DP-2 (INLET)	0.29	0.41						
	DP-20	15.88	16.76						
	BECKETT PROP	3.06	3.23						
	DP-MN1	7.07	37.20						
	DP-MN2	8.61	40.20						
	TRAVEL TIME								
	34.91	97.91	Type/flow	Length (ft)	Velocity (fps)	d. Time (min)	T. Time (min)		
					5.8	0.0	7.2		
27	D-31	0.11	0.14	7.1	4.6	8.1	0.5	1.2	
	TRAVEL TIME								
		0.11	0.14	Type/flow	Length (ft)	Velocity (fps)	d. Time (min)	T. Time (min)	
				139	8.4	0.3	7.3		
28	D-28	0.42	0.45	10.2	4.0	7.0	1.7	3.1	
	TRAVEL TIME								
		0.42	0.45	Type/flow	Length (ft)	Velocity (fps)	d. Time (min)	T. Time (min)	
				139	8.4	0.3	10.5		

**MARKET PLACE FILING NO. 1- PDR & FDR - DEVELOPED CONDITIONS
INLET CALCULATIONS**

DP	Inlet size L(i)	INLET TYPE	CROSS SLOPE	STREET SLOPE	Q(5)	Q(100)	Q ₅						Q ₁₀₀					
							Qi	CA(eqv.)	FB	CA(eqv.)	DEPTH (max)	SPREAD	Qi	CA(eqv.)	FB	CA(eqv.)	DEPTH (max)	SPREAD
2	15	FLOW-BY	2.0%	0.5%	7	13	5.3	1.02	2	0.29	0.42	16.9	8.8	0.97	4	0.41	0.51	21.2
3	10	SUMP	2.0%	SAG	6	11	6.0	1.16	0	0.00	0.50		10.9	1.20	0	0.02	0.50	
5	10	SUMP	2.0%	SAG	6	12	6.4	1.22	0	0.00	0.50		10.9	1.20	1	0.09	0.50	
6	15	FLOW-BY	2.0%	1.0%	9	17	6.4	1.34	3	0.62	0.42	16.7	10.7	1.27	7	0.80	0.51	21.0
10	15	FLOW-BY	2.0%	1.0%	9	17	6.5	1.37	3	0.64	0.42	16.8	10.7	1.31	7	0.82	0.51	21.1
13	20	SUMP	2.0%	SAG	9	17	9.4	1.94	0	0.00	0.50		17.2	2.04	0	0.00	0.50	
14	20	SUMP	2.0%	SAG	9	17	9.2	1.96	0	0.00	0.50		17.0	2.07	0	0.00	0.50	
15	20	SUMP	2.0%	SAG	11	20	10.6	2.09	0	0.00	0.50		18.9	2.14	1	0.07	0.50	
16	25	SUMP	2.0%	SAG	12	22	11.7	2.36	0	0.00	0.50		21.5	2.49	0	0.00	0.50	
19	5	FLOW-BY	2.0%	2.8%	1	1	0.4	0.09	0	0.06	0.19	5.3	0.4	0.05	0	0.04	0.19	5.4
21	25	SUMP	2.0%	SAG	10	12	10.2	3.13	0	0.00	0.50		12.3	2.17	0	0.00	0.50	
22	5	SUMP	2.0%	SAG	3	6	3.3	0.77	0	0.00	0.50		6.1	0.82	0	0.00	0.50	
27	5	FLOW-BY	2.0%	0.6%	1	1	0.4	0.08	0	0.03	0.21	6.2	0.8	0.10	0	0.05	0.25	8.4
28	10	FLOW-BY	2.0%	0.6%	2	3	1.4	0.35	0	0.08	0.28	9.7	2.3	0.33	1	0.12	0.33	12.2

Scenario: 100-year

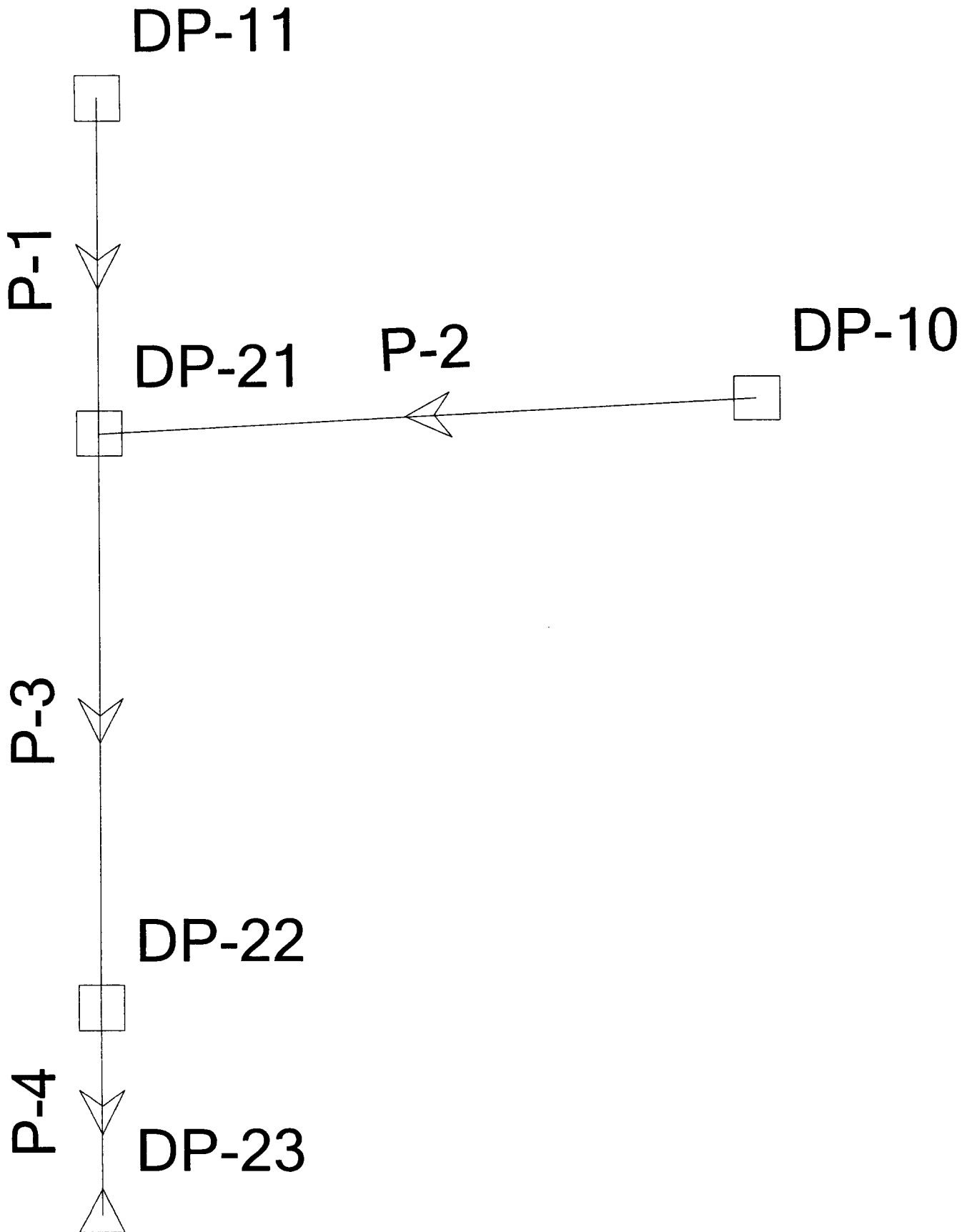

Calculation Results Summary

Scenario: 5-year

>>>> Info: DP-10 No bypass target specified. Bypass is assumed to travel to DP-23.

>>>> Info: Subsurface Network Rooted by: DP-23

>>>> Info: Subsurface Analysis iterations: 2

>>>> Info: Convergence was achieved.

CALCULATION SUMMARY FOR SURFACE NETWORKS

Label	Inlet Type	Inlet	Total Intercepted Flow (cfs)	Total Bypassed Flow (cfs)	Capture Efficiency (%)	Gutter Spread (ft)	Gutter Depth (ft)
DP-10	Curb Inlet	Curb Type R 10'	0.00	0.00	100.0	0.00	0.00
DP-22	Curb Inlet	Curb Type R 10'	3.38	0.00	100.0	9.11	0.16
DP-21	Curb Inlet	Curb Type R 10'	11.20	0.00	100.0	11.70	0.23
DP-11	Generic Inlet	Generic Default 100%	70.74	0.00	100.0	0.00	0.00

CALCULATION SUMMARY FOR SUBSURFACE NETWORK WITH ROOT: DP-23

Label	Number of Sections	Section Size	Section Shape	Length (ft)	Total System Flow (cfs)	Average Velocity (ft/s)	Hydraulic Grade Upstream (ft)	Hydraulic Grade Downstream (ft)
P-4	1	42 inch	Circular	27.33	68.60	8.78	6,842.51	6,842.26
P-3	1	42 inch	Circular	94.00	66.24	8.61	6,843.24	6,842.65
P-1	1	42 inch	Circular	36.02	70.74	8.87	6,843.83	6,843.51
P-2	1	18 inch	Circular	188.17	0.00	0.00	6,847.13	6,843.24

Label	Total System Flow (cfs)	Ground Elevation (ft)	Hydraulic Grade Line In (ft)	Hydraulic Grade Line Out (ft)
DP-23	68.53	6,842.00	6,839.66	6,839.66
DP-22	68.60	6,846.23	6,842.51	6,842.51
DP-21	66.24	6,846.47	6,843.24	6,843.24
DP-11	70.74	6,846.00	6,843.83	6,843.83
DP-10	0.00	6,850.88	6,847.13	6,847.13

Completed: 12/19/2005 12:20:11 PM

Scenario: 5-year

combined

Label	Up. Node	Dn. Node	L (ft)	Size	Up. Inlet Area (acres)	Up. Calc. Sys. CA (acres)	Up. Inlet Rat. Q (cfs)	System Rational Q (cfs)	Q Full (cfs)	Avg. v (ft/s)	Up. Gr Elev. (ft)	Up. HGL (ft)	Up. Invert (ft)	Dn. Gr. Elev. (ft)	Dn. HGL (ft)	Dn. Invert (ft)	S (ft/ft)	Desc.
P-4	DP-22	DP-23	27.33	42 inch	0.77	20.23	3.38	68.60	71.23	8.78	6,846.23	6,842.51	6,839.80	6,842.00	6,839.66	6,839.66	0.005013	
P-1	DP-11	DP-21	36.02	42 inch	16.17	16.17	70.74	70.74	71.12	8.87	6,846.00	6,843.83	6,841.05	6,846.47	6,843.24	6,840.87	0.004997	
P-3	DP-21	DP-22	94.00	42 inch	3.29	19.46	11.20	66.24	71.14	8.61	6,846.47	6,843.24	6,840.57	6,846.23	6,842.51	6,840.10	0.005000	
P-2	DP-10	DP-21	188.17	18 inch	0.00	0.00	0.00	0.00	16.35	0.00	6,850.88	6,847.13	6,847.13	6,846.47	6,843.24	6,842.57	0.024233	

Profile
Scenario: 5-year

Profile: Rolling Thunder Way

Scenario: 5-year

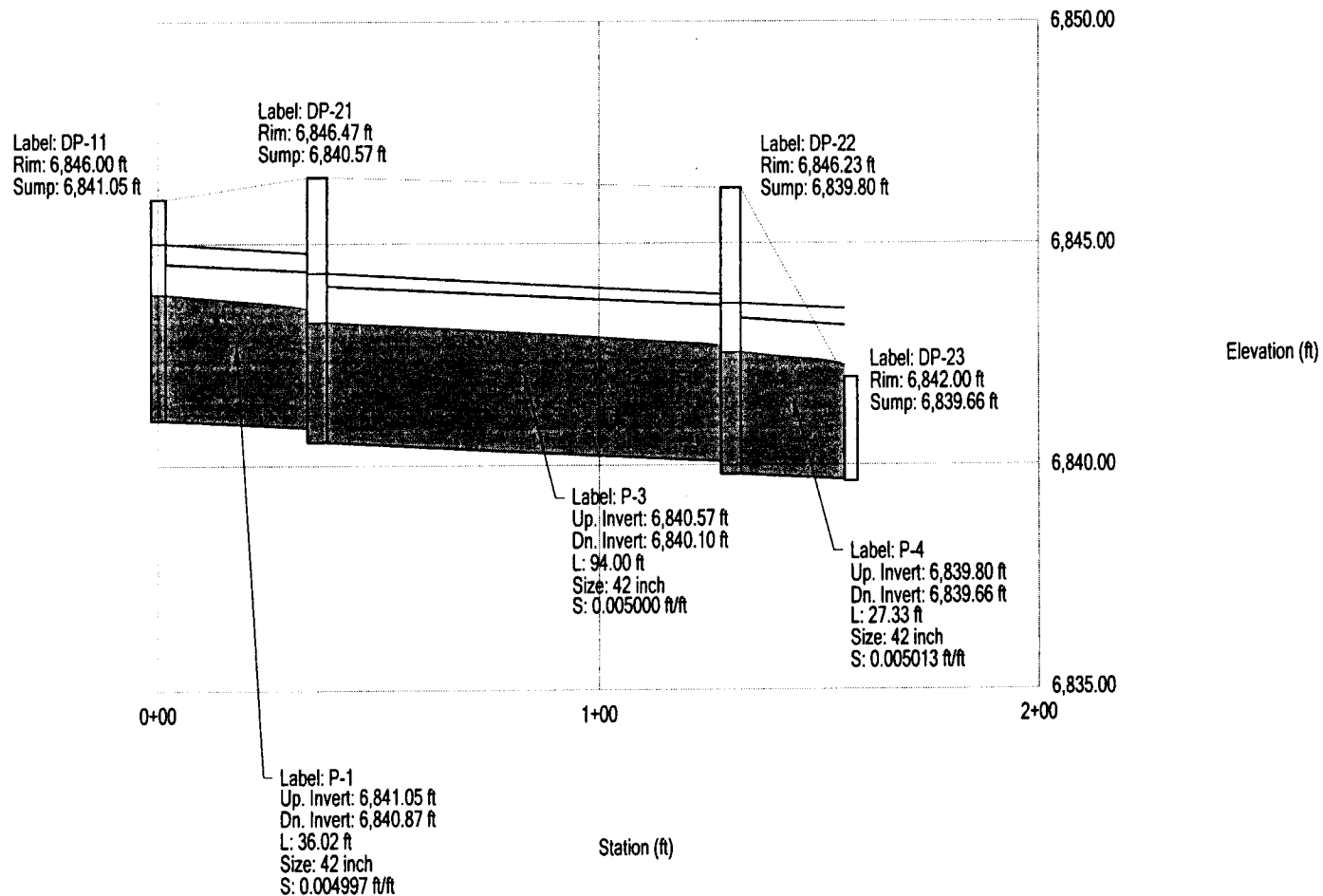

Profile
Scenario: 5-year

Profile: Meridian Road Connection-DP 10
Scenario: 5-year

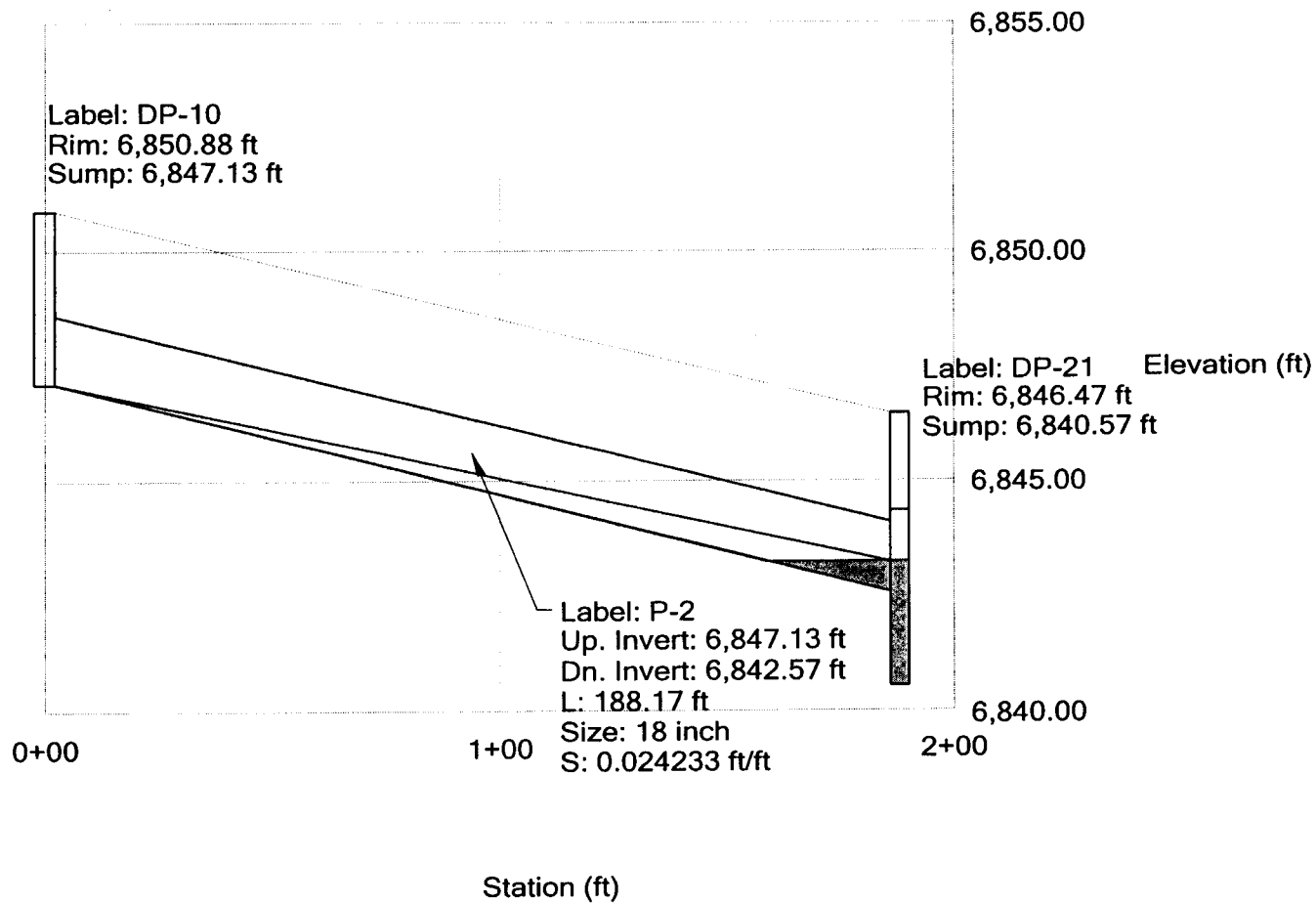

Calculation Results Summary

=====
 Scenario: 100-year

>>> Info: DP-10 No bypass target specified. Bypass is assumed to travel to DP-23.

>>> Info: Subsurface Network Rooted by: DP-23

>>> Info: Subsurface Analysis iterations: 2

>>> Info: Convergence was achieved.

CALCULATION SUMMARY FOR SURFACE NETWORKS

Label	Inlet Type	Inlet	Total Intercepted Flow (cfs)	Total Bypassed Flow (cfs)	Capture Efficiency (%)	Gutter Spread (ft)	Gutter Depth (ft)
DP-10	Curb Inlet	Curb Type R 10'	7.66	10.44	42.3	18.61	0.50
DP-22	Curb Inlet	Curb Type R 10'	6.41	0.00	100.0	15.86	0.32
DP-21	Curb Inlet	Curb Type R 10'	15.61	0.00	100.0	14.60	0.29
DP-11	Generic Inlet	Generic Default 100%	74.68	0.00	100.0	0.00	0.00

CALCULATION SUMMARY FOR SUBSURFACE NETWORK WITH ROOT: DP-23

Label	Number of Sections	Section Size	Section Shape	Length (ft)	Total System Flow (cfs)	Average Velocity (ft/s)	Hydraulic Grade Upstream (ft)	Hydraulic Grade Downstream (ft)
P-4	1	42 inch	Circular	27.33	83.82	9.65	6,842.89	6,842.52
P-3	1	42 inch	Circular	94.00	79.15	9.19	6,843.68	6,842.89
P-1	1	42 inch	Circular	36.02	74.68	8.89	6,843.95	6,843.68
P-2	1	18 inch	Circular	188.17	7.66	5.56	6,848.20	6,843.68

Label	Total System Flow (cfs)	Ground Elevation (ft)	Hydraulic Grade Line In (ft)	Hydraulic Grade Line Out (ft)
DP-23	83.74	6,842.00	6,839.66	6,839.66
DP-22	83.82	6,846.23	6,842.89	6,842.89
DP-21	79.15	6,846.47	6,843.68	6,843.68
DP-11	74.68	6,846.00	6,843.95	6,843.95
DP-10	7.66	6,850.88	6,848.20	6,848.20

=====
 Completed: 12/19/2005 12:19:10 PM

Scenario: 100-year

combined

Label	Up. Node	Dn. Node	L (ft)	Size	Up. Inlet Area (acres)	Up. Calc. Sys. CA (acres)	Up. Inlet Rat. Q (cfs)	System Rational Q (cfs)	Q Full (cfs)	Avg. v (ft/s)	Up. Gr Elev. (ft)	Up. HGL (ft)	Up. Invert (ft)	Dn. Gr. Elev. (ft)	Dn. HGL (ft)	Dn. Invert (ft)	S (ft/ft)	Desc.
P-4	DP-22	DP-23	27.33	42 inch	0.82	13.90	6.41	83.82	71.23	9.65	6,846.23	6,842.89	6,839.80	6,842.00	6,839.66	6,839.66	0.005013	
P-1	DP-11	DP-21	36.02	42 inch	9.60	9.60	74.68	74.68	71.12	8.89	6,846.00	6,843.95	6,841.05	6,846.47	6,843.68	6,840.87	0.004997	
P-3	DP-21	DP-22	94.00	42 inch	2.58	13.08	15.61	79.15	71.14	9.19	6,846.47	6,843.68	6,840.57	6,846.23	6,842.89	6,840.10	0.005000	
P-2	DP-10	DP-21	188.17	18 inch	2.13	0.90	18.10	7.66	16.35	5.56	6,850.88	6,848.20	6,847.13	6,846.47	6,843.68	6,842.57	0.024233	

Profile
Scenario: 100-year

Profile: Rolling Thunder Way

Scenario: 100-year

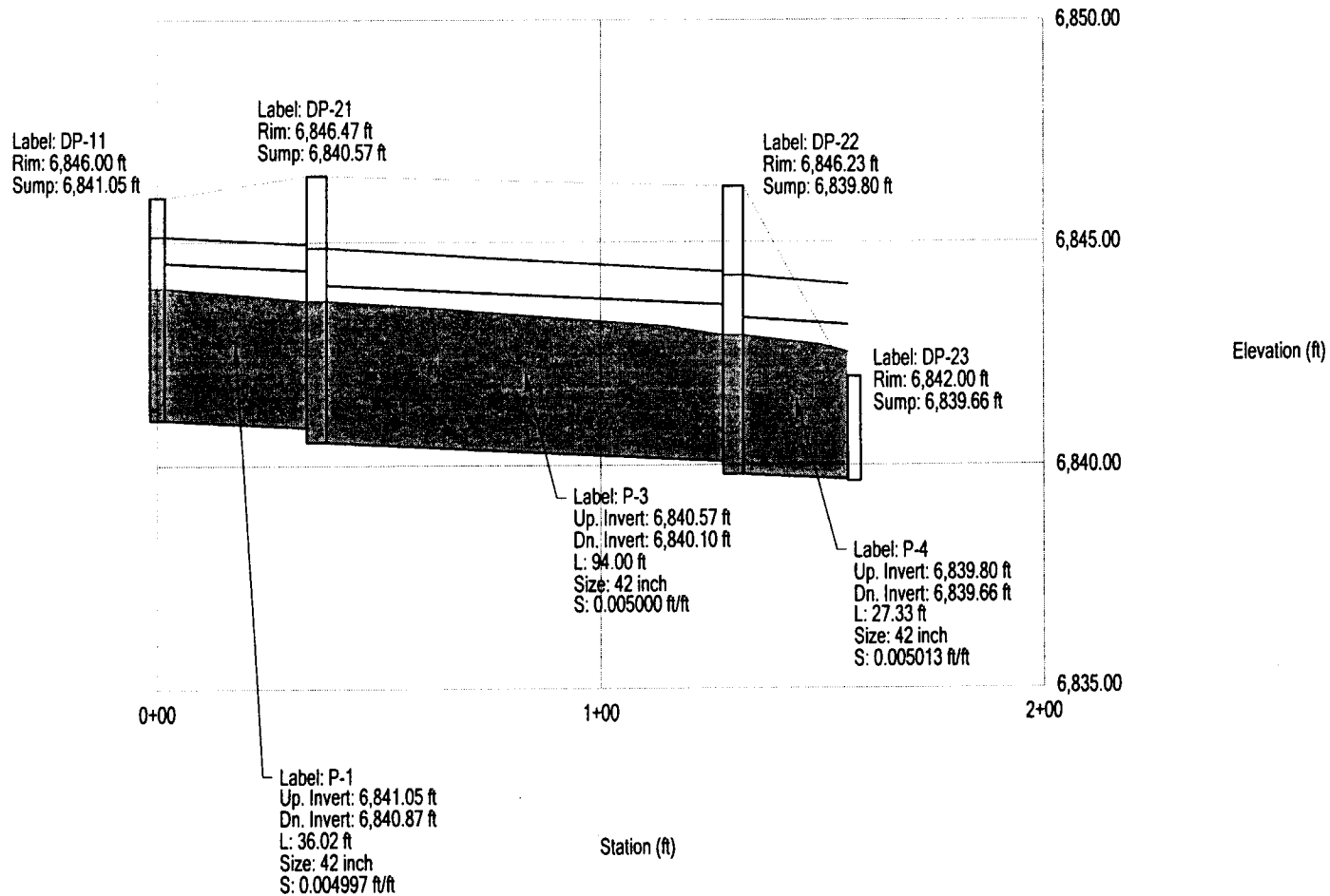

Profile
Scenario: 100-year

Profile: Meridian Road Connection-DP 10
Scenario: 100-year

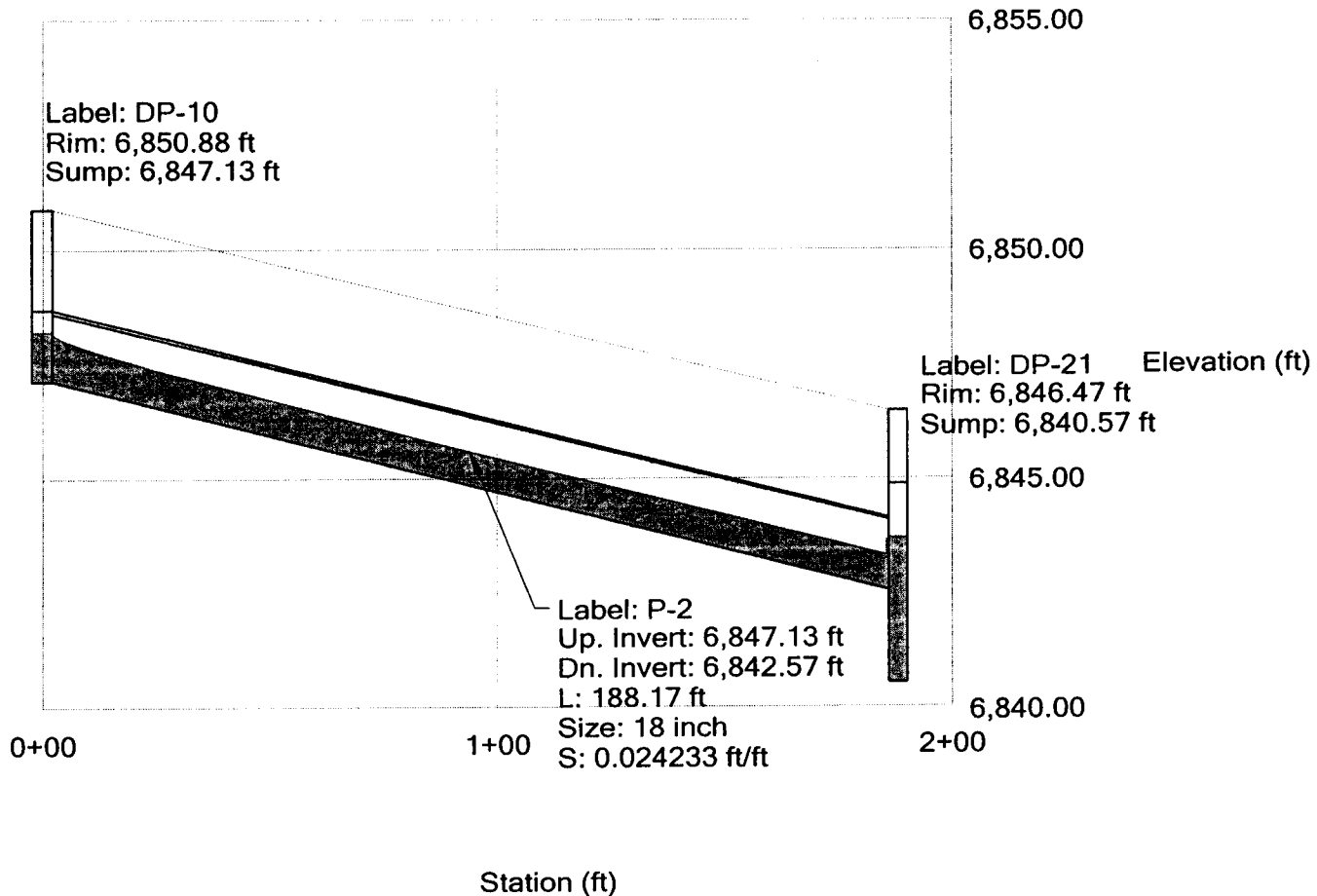



Market Place Filing No. 2
FINAL DRAINAGE LETTER
El Paso County, Colorado
November, 2008

Prepared for:

Phantom II Partners
6255 Barrel Race Dr
Colorado Springs, Colorado 80923

Prepared by:

Springs Engineering
31 N Tejon Street
Suite 315
Colorado Springs, CO 80903
Phone: 719-227-7388

Project No. 078-08-018

VERSION # 1
DATE 12/1/08

Market Place Filing No. 2
Final Drainage Report/Letter

proposed low point, DP-C. At this location a curb cut will be installed, along with a small riprap drainage swale to direct flows to a proposed Type C inlet. Flows from this basin are 2.7 cfs and 5.1 cfs for the 5 and 100-year events, respectively.

Basin D-25d is 0.26 acres. This basin consists of the majority of the proposed private roadway. Flow is conveyed through the curb and gutter to the south. At DP-D, on the south side of the roadway, prior to the Meridian Road intersection, a 5' Type R inlet will be installed. This basin generates 1.2 cfs for the 5-year storm and 2.2 cfs for the 100-year storm.

Basin D-25e is 1.49 acres and consists of the eastern portion of Lot 2, which is not currently being developed. This basin will have grading occur for grades to match into existing from the proposed private roadway. Flows in this basin will sheetflow down the proposed slope til meeting existing ground, at which time flows will continue to a proposed temporary channel along Meridian Road.

Basin D-25f is 0.05 acres and consists of the entrance of the private roadway from Meridian Road. This basin will sheetflow across the pavement to a proposed curb cut. A riprap rundown will convey this flow into the proposed channel along Meridian Road. Flows at this location are 0.2 and 0.4 cfs for the minor and major storms.

STORM SYSTEM:

There are two storm systems designed for this site. Design Point B is a 5' type R sump inlet which intercepts flow from Basin D-25b. It will cross under the proposed private roadway through an 18" rcp, which releases into the proposed channel.

DP-C is a type C inlet, which will intercept flow from Basin D-25c. Flows from this basin will be directed towards the inlet via a riprap swale from the curb cut located in the parking lot. Inlet DP-C will connect to a 5' type R inlet located in the private road. From this inlet, the system will release into the proposed temporary ditch. Both pipes in this system are 24" rcp. Riprap protection will be installed at the outlet of the pipe. Refer to the appendix for an analysis of both storm systems.

The temporary channel is designed to carry a flow of 13.1 cfs. The channel geometry consists of a trapezoidal ditch with a 5' bottom width, 4 to 1 side slopes, a channel slope of 1.0 % and a height of 2'. Based on these parameters, the channel will have a velocity of 2.61 ft/s and a flow depth of 8.0 inches. The velocity is well within the range allowed by the criteria manual for a natural channel, and there is 16 inches of freeboard for the channel. Design of this channel is included in the appendix.

From this location, Basin D25e and flow from the channel are all combined at DP-11, an existing culvert under Rolling Thunder Way. From this report, DP-11 has flows of 36.7 cfs and 67.7 cfs. The approved Market Place Filing No. 1 Report shows flows of 38.7 and 71.3 cfs. Based on the new analysis for this area, the developed flows at DP-11 are less than those previously assumed. Therefore there will be no adverse impacts to any of the downstream facilities from this area.

WATER QUALITY:

No water quality will be necessary for this site, as all flows are directed towards Pond WU which has a water quality facility.

POND WU DISCUSSION:

All previous drainage reports (including Falcon Highlands Market Place Filing No. 1 FDR) have shown storm runoff from Lot 7 to enter Pond WU. Based on the proposed conditions for the area, the construction of this project the outlet structure of the pond will need to be modified. Based on the entire build out of the Falcon Highlands development, a recommendation has been determined, which will allow the 5-year storm to release at a historic rate. This recommendation also enhances the 100-year release rate from the pond. The recommendation, to ensure the 5-year historic release rate is to cover on the of the two grate openings on top of the orifice pipes and to cover both of the 24" pipe openings in the headwall. This will leave all of the 12" pipes open and the second grate open. Based on these modifications, the historic rates will be met. See Table below for comparison of flows.

Design Point	5-Yr Historic	5-Yr Proposed	100-Yr Historic	100-Year Proposed
WU	148	141	1657	1132
WV	149	149	1650	1120

EROSION CONTROL

During construction, best management practices for erosion control will be employed based on the City of Colorado Springs/El Paso County Drainage Criteria and Volume II (the Erosion Control Manual) and the erosion control plans. During construction, silt fencing, a temporary sediment basin and vehicle-tracking controls will be in place to minimize erosion from the site. Silt fencing will be placed along the south (downhill) side of the site. This will inhibit suspended sediment from leaving the site during construction. Silt fencing is to remain in place until vegetation is reestablished after completion of construction. The sediment basin will be graded in along the proposed temporary channel, downstream of all construction activities. Best erosion control practices will be utilized as deemed necessary by the Contractor, Engineer or County Inspector and are not limited to the measures described above.

CONCLUSION

The proposed drainage design will be effective to control damage from design storm runoff. This Drainage Report for the Site is in accordance with Section 4.5 of the El Paso County Drainage Criteria manual.

If you have any questions or comments, please contact me at 719-227-7388.

Sincerely,
Springs Engineering

Charlene Sammons, P. E..
Project Engineer

DEVELOPED DRAINAGE PLAN MARKET PLACE FILING NO. 2

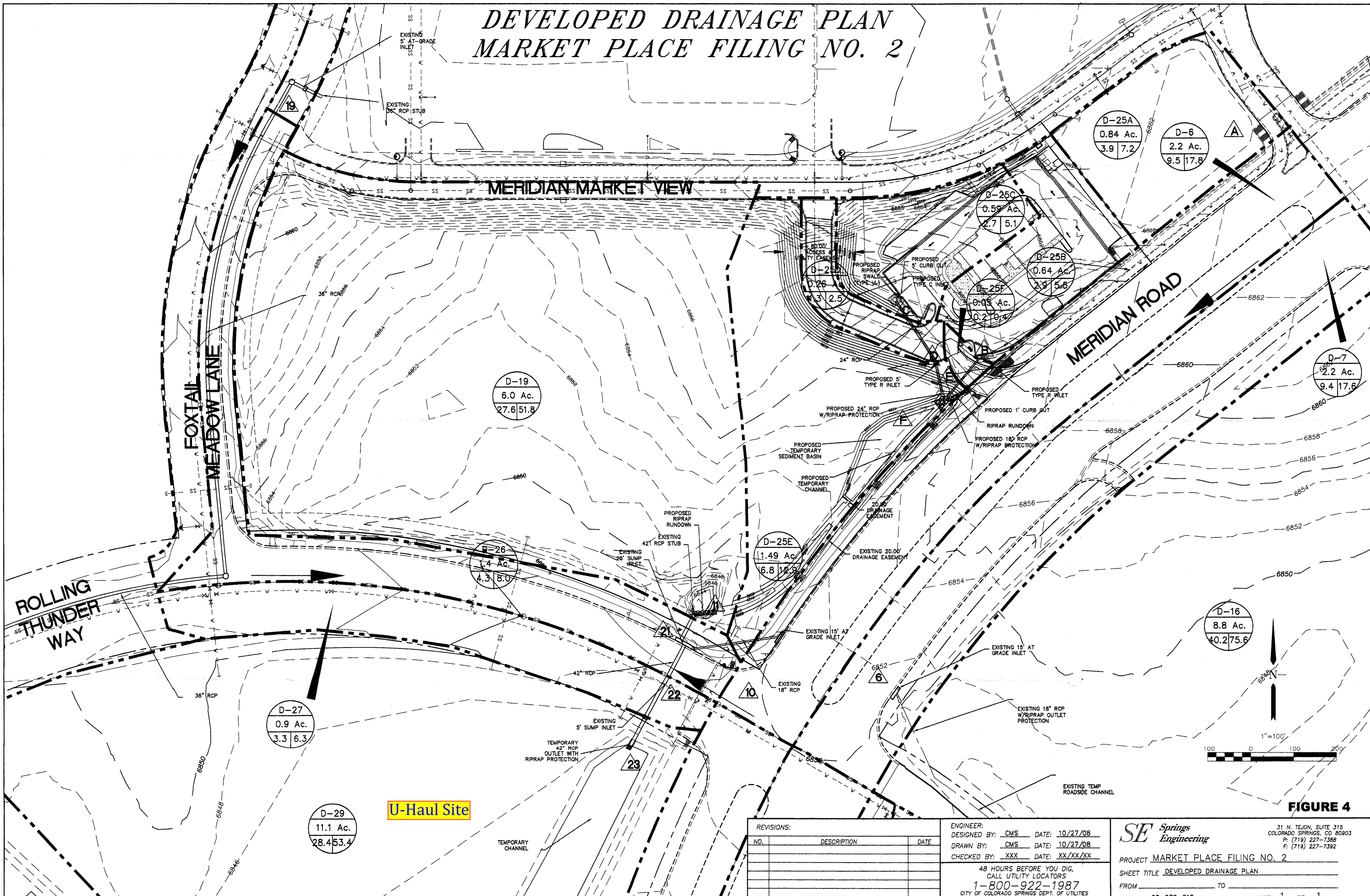

U-Haul Site

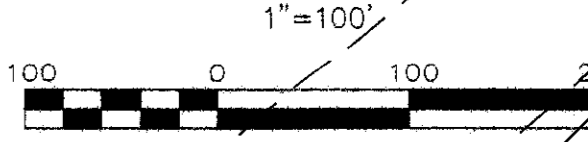

FIGURE 4

REVISIONS:		
NO.	DESCRIPTION	DATE

ENGINEER:	DESIGNED BY: <u>CMS</u>	DATE: <u>10/27/08</u>
	DRAWN BY: <u>CMS</u>	DATE: <u>10/27/08</u>
	CHECKED BY: <u>XXX</u>	DATE: <u>XX/XX/XX</u>

48 HOURS BEFORE YOU DIG,
CALL UTILITY LOCATORS
1-800-922-1987
CITY OF COLORADO SPRINGS DEPT. OF UTILITIES
GAS, ELECTRIC, WATER AND WASTEWATER

SE Springs Engineering
31 N. TEJON, SUITE 315
COLORADO SPRINGS, CO 80903
P: (719) 227-7388
F: (719) 227-7392

PROJECT MARKET PLACE FILING NO. 2
SHEET TITLE DEVELOPED DRAINAGE PLAN
FROM _____ TO _____
JOB NO. 08-078-01B SHEET 1 OF 1

DESIGN POINT	CONTRIBUTING BASINS	CA (equivalent)		Tc (min.)	INTENSITY		TOTAL FLOWS	
		CA(5)	CA(100)		I(5) (in/hr)	I(100) (in/hr)	Q(5) (cfs)	Q(100) (cfs)
10	D-6	2.02	2.13	6.8	4.7	8.2	9.5	17.5
		TRAVEL TIME						
		2.02	2.13	Type/flow	Length (ft)	Velocity (fps)	d. Time (min)	T. Time (min)
					83	5.8	0.2	7.0
11	D-19 D-25e DP-E	5.40	5.70	7.6	4.5	7.9	36.7	67.7
		1.34	1.42					
		1.38	1.46	TRAVEL TIME				
		8.13	8.58	Type/flow	Length (ft)	Velocity (fps)	d. Time (min)	T. Time (min)
				0.0	0.0	7.6		
13	D-12	1.94	2.04	6.3	4.8	8.4	9.4	17.2
		TRAVEL TIME						
		1.94	2.04	Type/flow	Length (ft)	Velocity (fps)	d. Time (min)	T. Time (min)
			98	6.1	0.3	6.5		
14	D-11	1.96	2.07	6.8	4.7	8.2	9.2	17.0
		TRAVEL TIME						
		1.96	2.07	Type/flow	Length (ft)	Velocity (fps)	d. Time (min)	T. Time (min)
				5.2	0.0	6.8		
15	D-15	2.09	2.20	5.4	5.1	8.9	10.6	19.6
		TRAVEL TIME						
		2.09	2.20	Type/flow	Length (ft)	Velocity (fps)	d. Time (min)	T. Time (min)
			347	2.0	2.9	8.3		
16	D-14	2.36	2.49	5.8	5.0	8.6	11.7	21.5
		TRAVEL TIME						
		2.36	2.49	Type/flow	Length (ft)	Velocity (fps)	d. Time (min)	T. Time (min)
			62	9.0	0.1	5.9		
17	DP-7 DP-13 D-17 OFFSITE	8.51	9.12	8.7	4.3	7.5	157.9	300.6
		1.94	2.04					
		21.50	22.70					
		4.89	6.28	TRAVEL TIME				
		36.83	40.14	Type/flow	Length (ft)	Velocity (fps)	d. Time (min)	T. Time (min)
			36	1.5	0.4	9.1		
18	DP-17 DP-15 (INLET) DP-16 (INLET)	36.83	40.14	5.9	4.9	8.6	181.2	345.5
		0.00	0.07					
		0.00	0.00	TRAVEL TIME				
		36.83	40.21	Type/flow	Length (ft)	Velocity (fps)	d. Time (min)	T. Time (min)
			139	8.4	0.3	6.2		

Entrance to Ex. 42" RCP at NE corner site under Rolling Thunder

DESIGN POINT	CONTRIBUTING BASINS	CA(equivalent)		Tc (min.)	INTENSITY		TOTAL FLOWS	
		CA(5)	CA(100)		I(5) (in/hr)	I(100) (in/hr)	Q(5) (cfs)	Q(100) (cfs)
19	D-18	0.72	0.76	5.5	5.0	8.8	3.6	6.7
		TRAVEL TIME						
		0.72	0.76	Type/flow	Length (ft)	Velocity (fps)	d. Time (min)	T. Time (min)
					62	9.0	0.1	5.7
21	D-26	1.28	1.35	16.2	3.2	5.7	10.2	12.3
	DP-10 (INLET)	0.64	0.82					
	D-22	1.15	1.22					
	DP-19 (INLET)	0.06	0.04					
		TRAVEL TIME						
		3.13	2.17	Type/flow	Length (ft)	Velocity (fps)	d. Time (min)	T. Time (min)
					139	8.4	0.3	16.5
22	D-27	0.77	0.82	8.7	4.3	7.5	3.3	6.1
	DP 21 (INLET)	0.00	0.00					
	TRAVEL TIME							
		0.77	0.82	Type/flow	Length (ft)	Velocity (fps)	d. Time (min)	T. Time (min)
					139	8.4	0.3	8.9
23	DP-11	8.13	8.58	10.5	4.0	6.9	35.3	65.1
	DP-22 (INLET)	0.77	0.82					
	TRAVEL TIME							
		8.90	9.39	Type/flow	Length (ft)	Velocity (fps)	d. Time (min)	T. Time (min)
					139	8.4	0.3	10.8
24	D-29	10.03	10.58	22.5	2.7	4.8	51.7	95.4
	DP-23	8.90	9.39					
	TRAVEL TIME							
		18.93	19.98	Type/flow	Length (ft)	Velocity (fps)	d. Time (min)	T. Time (min)
					83	5.8	0.2	22.7
25	DP-18	36.83	40.21	13.0	3.6	6.3	221.9	1479.1
	POND WU	19.44	188.25					
	DP-14	1.96	2.07					
	D-30	3.29	4.23					
	TRAVEL TIME							
		61.53	234.76	Type/flow	Length (ft)	Velocity (fps)	d. Time (min)	T. Time (min)
					83	5.8	0.2	13.3

Ex. 42" RCP at NE corner site under Rolling Thunder draining into U-Haul site

Basin D-29 is U-Haul site. DP 24 is U-Haul site plus Ex. 42" RCP flows



MDDP & DBPS AMENDMENT

BENT GRASS DEVELOPMENT

El Paso County, Colorado

PREPARED FOR:
Challenger Communities, LLC
8605 Explorer Dr., Suite 250
Colorado Springs, CO 80920

PREPARED BY:
Galloway & Company, Inc.
1155 Kelly Johnson Blvd., Suite 305
Colorado Springs, CO 80920

DATE:
January 2021
Revised: March 2021
Revised: April 2021
Revised: June 2021
Revised: August 2021
Revised: September 2021

PUDSP-20-005



any new development and detention will be required for new development north of Bent Grass Meadows Drive. Also, in the future conditions scenario, Pond SR-4 and existing Pond MN from the Falcon DBPS will receive flows from the improved school site. The HEC-HMS has been updated and is included in Appendix B. As discussed previously, the "School Site" have been added as an additional Basin MT060a, which is routed to the regional detention facility SR-4.

Basin MT070, described in the Falcon DBPS, was analyzed to include the improvements made to the site within Basin MT070 and the effects it has on existing Pond MN.

From the analysis, Pond SR-4's 100-yr. receiving flows increased from 1,000 cfs to 1072.8 cfs. Based on the increase in impervious area, Basin MT070's Curve Number increased from 67 to 68. Subsequently, the 100-yr. receiving flows entering existing Pond MN decreased to 727.3 cfs from 850 cfs.

Release rates for SR-4 are 14.8 cfs for the 2-year storm and 700.3 cfs for the 100-year storm. Falcon DBPS has 2-year storm listed as 27 cfs and 100-year storm as 730 cfs. This gives a decrease of 12.2 cfs and 29.7 cfs for the 2 and 100-year events respectively.

Pond MN release rates 14.4 cfs for the 2-year storm and 691.7 cfs for the 100-year storm. The DBPS has release rates listed as 32 cfs for the 2-year storm and 820 cfs for the 100-year storm. This gives a decrease of 17.6 cfs and 128.3 cfs for the 2 and 100-year events respectively.

The West Tributary site does include the addition of proposed water quality ponds with the Bent Grass development, under the current scenario. Under future conditions, additional water quality facilities will be necessary for any other new developments. Existing Pond WU, further south in the West Tributary, near Highway 24, is a regional detention facility for areas (approximately 2,312 acres) just upstream of the pond, as well as providing water quality for the west side of the same Falcon Highlands area.

Pond WU release rates 45.9 for the 2-year storm and 921.2 cfs for the 100-year storm. The DBPS has release rates listed as 55 cfs for the 2-year storm and 1000 cfs for the 100-year storm. This gives a decrease of 9.1 cfs and 78.8 cfs for the 2 and 100-year events respectively.

XI. Maintenance

The proposed channels are to be private facilities. They will be maintained by the Bent Grass Metropolitan district. When completion of future DBPS construction improvements and upon the Board of County Commissioners acceptance the channels, Reaches RWT 204 & RWT210, will then be owned and maintained by El Paso County along with all drainage facilities within the public Right-of-Way.

XII. Wetlands Mitigation

No wetlands are located on site.

XIII. Floodplain Statement

According to the Federal Emergency Management Agency (FEMA) Flood Insurance Rate Map number 08041C0553G, effective December 7, 2018, there is a floodplain in a portion of the project area. A copy of the FIRM Panel is included in Appendix A.

The portion of channel that has a floodplain designation is only the RWT210 and RWT204 portions of the channel. It is unknown why the western channel, RWT202 is unmapped since it is the larger contributor

STAGE - STORAGE - DISCHARGE TABLE (POND WU - OUTLET REVISIONS)

per UDFCD UD-Detention Spreadsheet

Elevation	Stage	Orifice Plate	Horiz Weir	Total Collection Capacity (WOCV & Weir)	Controlling Flowrate Culvert #1 (48")	Controlling Flowrate Culvert #2 (60")	Controlling Flowrate Culvert #3 (60")	Controlling Flowrate Culvert #4 (60")	Total Controlling Flowrate - Outlet Culverts	Spill Way	Total Outflow*
[ft]	[ft]	[cfs]	[cfs]	[cfs]	[cfs]	[cfs]	[cfs]	[cfs]	[cfs]	[cfs]	[cfs]
6816.30	0.00	0.00	0.00	0.00	0.00	0.00	0.00	0.00	0.00	0.00	0.00
6818.20	1.90	1.34	0.00	1.34	1.34	1.34	1.34	1.34	5.36	0.00	1.34
6819.00	2.70	2.18	0.00	2.18	2.18	2.18	2.18	2.18	8.72	0.00	2.18
6820.00	3.70	3.28	0.00	3.28	3.28	3.28	3.28	3.28	13.12	0.00	3.28
6821.00	4.70	4.53	0.00	4.53	4.53	4.53	4.53	4.53	18.12	0.00	4.53
6822.00	5.70	5.90	78.71	84.61	84.61	84.61	84.61	84.61	338.44	0.00	84.61
6823.00	6.70	6.91	544.70	551.61	116.75	134.68	153.58	150.75	555.76	0.00	551.61
6824.00	7.70	7.76	1233.69	1241.44	135.78	174.76	189.73	187.47	687.74	0.00	687.74
6825.00	8.70	8.51	2087.92	2096.43	152.52	207.28	220.03	218.07	797.90	0.00	797.90
6826.00	9.70	9.19	3080.00	3089.19	167.63	235.34	246.62	244.87	894.46	0.00	894.46
6827.00	10.70	9.83	4192.88	4202.71	181.43	260.37	270.62	269.03	981.45	0.00	981.45
6828.00	11.70	10.42	5414.65	5425.07	194.30	283.23	292.66	291.20	1061.39	0.00	1061.39
6829.00	12.70	10.98	6249.18	6260.16	206.36	304.32	313.16	311.78	1135.62	16.43	1152.05
6830.00	13.70	11.52	6659.12	6509.89	217.74	324.10	332.39	331.10	1205.33	148.29	1353.62
6830.20	13.90	11.62	6738.12	6509.99	219.95	327.91	336.10	334.82	1218.78	183.81	1402.59

* - Based on Spillway flow plus lesser flow of Total Collection Capacity (WOCV & Weir) or Total Controlling Flowrate - Outlet Culverts

FUTURE HMS MODEL - 100 YEAR STORM

Hydrologic Element	Drainage Area (MI ²)	Peak Discharge (CFS)	Time of Peak	Volume (AC-FT)
RWT150	0.14453	193.3	01Jan2011, 06:22	16.8
WT150-REV	0.13081	202.5	01Jan2011, 06:08	15
Paint Brush Hills Pond B1	0.27534	235.6	01Jan2011, 06:29	31.8
W34B2-REV	0.09359	141.8	01Jan2011, 06:07	10.2
Paint Brush Hills Pond B2	0.36893	234.3	01Jan2011, 06:43	38.9
JWT150	0.36893	234.3	01Jan2011, 06:43	38.9
RWT160	0.36893	234.2	01Jan2011, 06:49	38.8
WT160-REV	0.07348	109.9	01Jan2011, 06:06	7.5
JWT160	0.44241	244.8	01Jan2011, 06:48	46.3
RWT174	0.44241	244.7	01Jan2011, 06:56	46.2
WT170-REV	0.106015	85.2	01Jan2011, 06:19	9.2
W34-CY-REV	0.0465469	38.1	01Jan2011, 06:16	3.8
JWT172	2.378328	981.9	01Jan2011, 06:56	199.7
RWT176	2.378328	981.6	01Jan2011, 06:57	199.7
Sub Regional Pond SR2	2.378328	972.9	01Jan2011, 07:01	194.8
JWT174	2.378328	972.9	01Jan2011, 07:01	194.8
RWT180	2.378328	972.1	01Jan2011, 07:10	194.2
WT180-REV	0.04094	29.3	01Jan2011, 06:19	3.2
JWT180	2.419268	978	01Jan2011, 07:10	197.4
RWT202	2.419268	977.7	01Jan2011, 07:16	197.1
WT200-N	0.191	121	01Jan2011, 06:29	16.5
WT200-W	0.068	64.4	01Jan2011, 06:13	5.9
WT190	0.0574561	74.7	01Jan2011, 06:05	5
The Meadows Pond #1	0.0574561	2.1	01Jan2011, 08:29	2.8
JWT190	0.0574561	2.1	01Jan2011, 08:29	2.8
RWT204	0.0574561	2.1	01Jan2011, 08:46	2.7
40	2.7357241	1029.1	01Jan2011, 07:15	222.1
RWT206	2.7357241	1027.9	01Jan2011, 07:17	221.9
BG	0.184	255.6	01Jan2011, 06:17	24.7
WT210-N	0.074	77.5	01Jan2011, 06:17	7.8
CC	2.9937241	1075.3	01Jan2011, 07:16	254.4
RWT210	2.9937241	1074.9	01Jan2011, 07:20	254.1
WT210-S	0.117	116.2	01Jan2011, 06:19	12.4
JWT210	3.1107241	1093.7	01Jan2011, 07:20	266.5
RWT232	3.1107241	1093.3	01Jan2011, 07:23	266.1
WT220-S	0.118	178.8	01Jan2011, 06:08	13.3
JWT220	0.118	178.8	01Jan2011, 06:08	13.3
RWT234	0.118	177.6	01Jan2011, 06:18	13.3
JWT232	3.2287241	1107.7	01Jan2011, 07:23	279.4
RWT236	3.2287241	1107.7	01Jan2011, 07:23	279.4
WT230	0.19818	346.7	01Jan2011, 06:05	23.1
JWT234	3.4269041	1125.3	01Jan2011, 07:23	302.4

West Trib adj
to U-Haul site

FUTURE HMS MODEL - 100 YEAR STORM

Hydrologic Element	Drainage Area (MI ²)	Peak Discharge (CFS)	Time of Peak	Volume (AC-FT)
RWT240	3.4269041	1124.7	01Jan2011, 07:26	302.2
WT240	0.0761461	160.3	01Jan2011, 06:01	9.1
Regional Pond WU North	3.5030502	1130.7	01Jan2011, 07:27	310.1
Regional Pond WU Diversion	3.5030502	1092	01Jan2011, 07:27	266.8
Old Meridian	0.03359	85	01Jan2011, 06:07	6.1
RWT-OM	0.03359	84.2	01Jan2011, 06:12	6.1
Regional Pond WU South	3.5366402	921.2	01Jan2011, 07:48	265.7
RWT240_Diversion Reach	0	38.7	01Jan2011, 07:32	43.1
JWT240	3.5366402	959.8	01Jan2011, 07:48	308.8
RWT250	3.5366402	959.5	01Jan2011, 07:49	308.7
WT250	0.14695	291.4	01Jan2011, 06:02	17.1
JWT250	3.6835902	971.8	01Jan2011, 07:49	325.8
RWT260	3.6835902	971.4	01Jan2011, 07:59	324.8
WT260	0.1388002	77.5	01Jan2011, 06:34	11.5
JWT260	3.8223904	985.5	01Jan2011, 07:58	336.4
RWT291	3.8223904	985.4	01Jan2011, 08:01	336.1
WT270	0.0324738	57.1	01Jan2011, 06:04	3.6
JWT270	0.0324738	57.1	01Jan2011, 06:04	3.6
RWT292	0.0324738	56.9	01Jan2011, 06:08	3.5
JWT292	3.8548642	988	01Jan2011, 08:01	339.7
RWT295	3.8548642	987.9	01Jan2011, 08:02	339.6
WT280	0.26695	251.8	01Jan2011, 06:12	22.3
JWT280	0.26695	251.8	01Jan2011, 06:12	22.3
RWT294	0.26695	251.2	01Jan2011, 06:15	22.2
JWT294	4.1218142	1005.7	01Jan2011, 08:02	361.8
RWT296	4.1218142	1005.3	01Jan2011, 08:07	361.1
MT040	0.30842	455.2	01Jan2011, 06:11	38.1
MT030	0.15663	228.6	01Jan2011, 06:05	15.1
MT020	0.0902033	143.1	01Jan2011, 06:04	9
JMT020	0.0902033	143.1	01Jan2011, 06:04	9
RMT030	0.0902033	141.8	01Jan2011, 06:17	8.9
JMT030	0.2468333	294.4	01Jan2011, 06:07	24
RMT040	0.2468333	293	01Jan2011, 06:11	24
Woodmen Hills Pond H	0.5552533	751.7	01Jan2011, 06:11	61.7
JMT040	0.5552533	751.7	01Jan2011, 06:11	61.7
RMT050	0.5552533	745.8	01Jan2011, 06:14	61.7
MT050	0.11861	109.7	01Jan2011, 06:18	11.4
JMT050	0.6738633	851.9	01Jan2011, 06:14	73.1
RMT062	0.6738633	849.2	01Jan2011, 06:16	73
MT010	0.28989	139.9	01Jan2011, 06:24	17.7
The Meadows Pond #2	0.28989	63.5	01Jan2011, 06:55	14.1
JMT010	0.28989	63.5	01Jan2011, 06:55	14.1

U-Haul is in
this basin

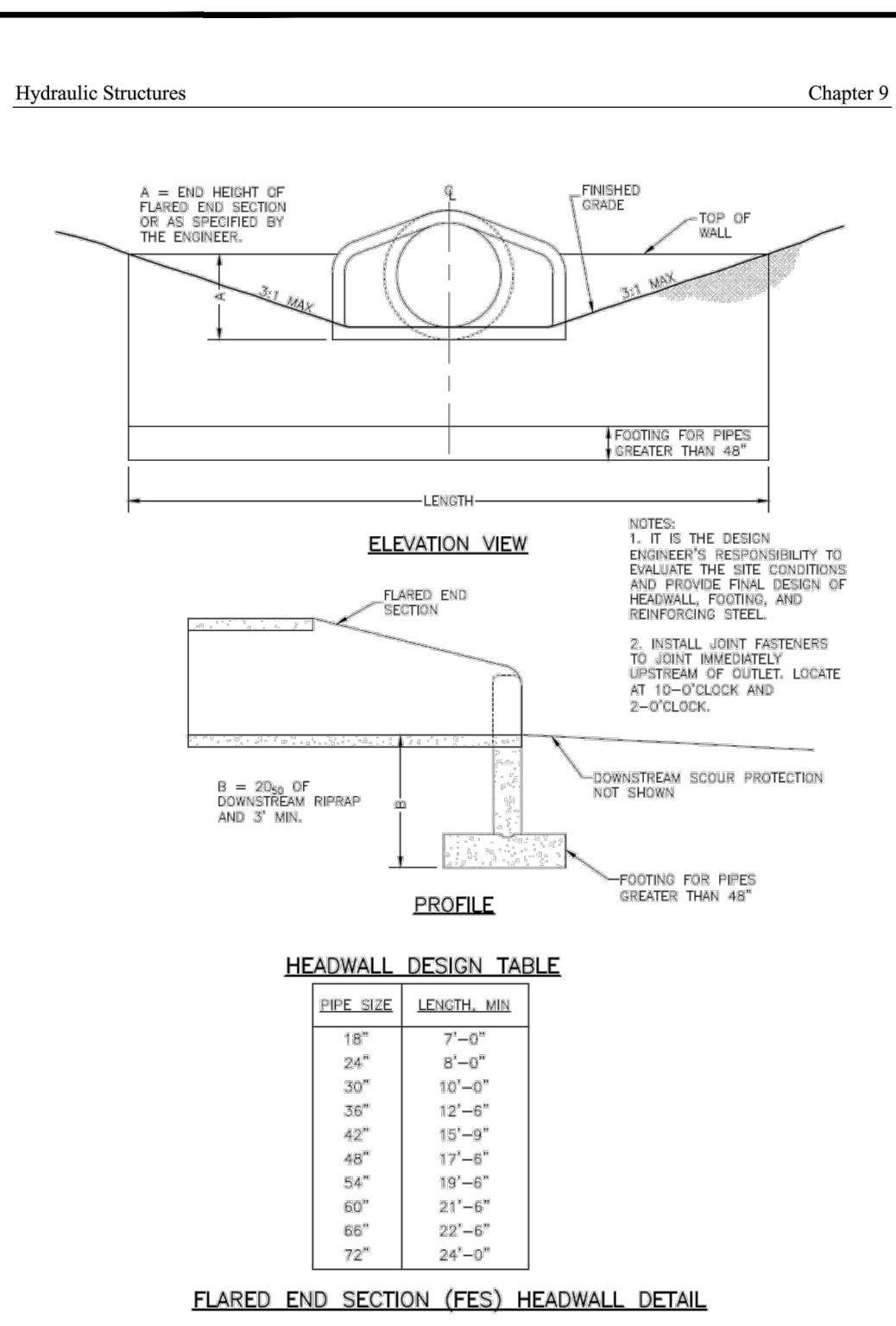
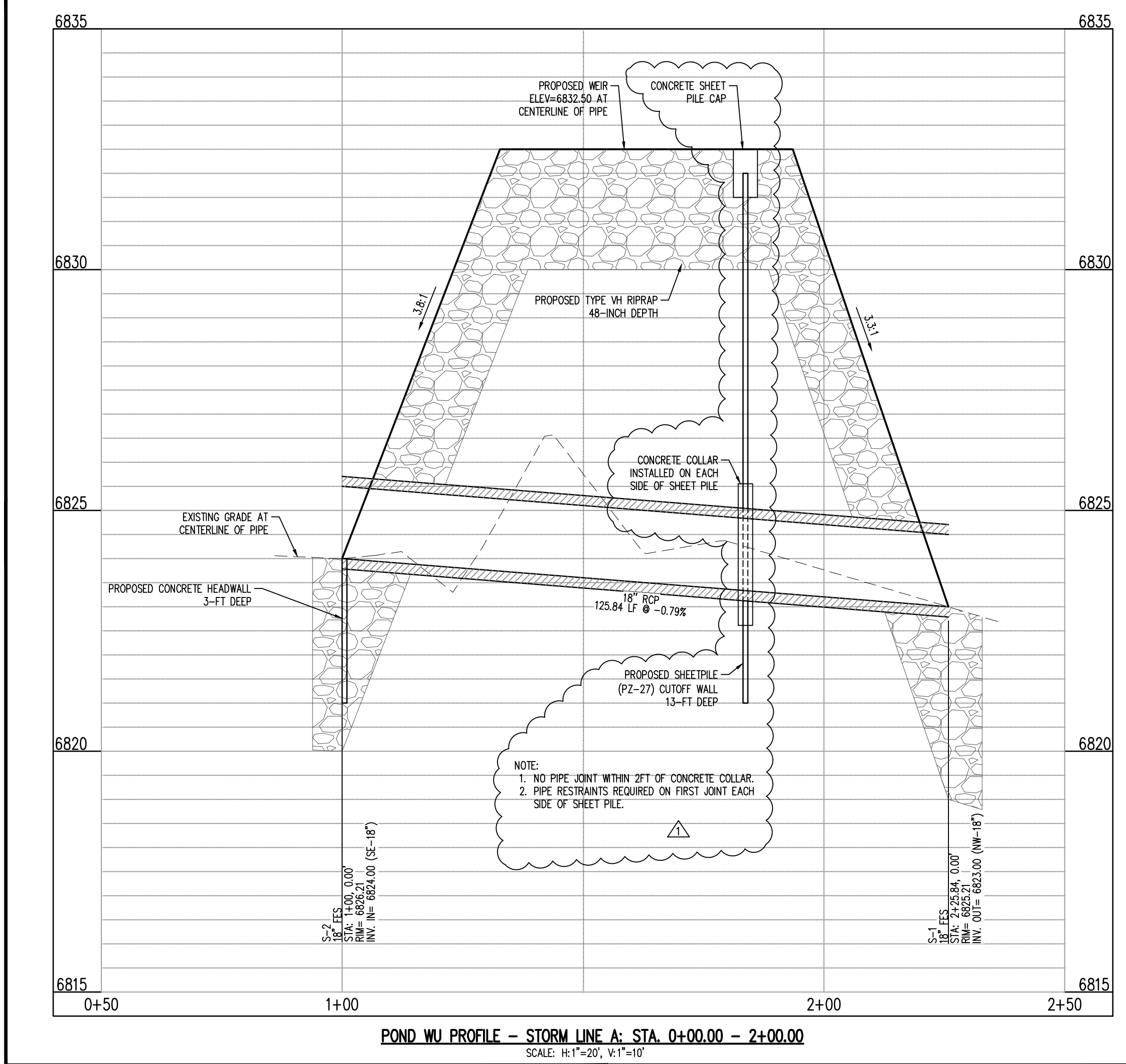
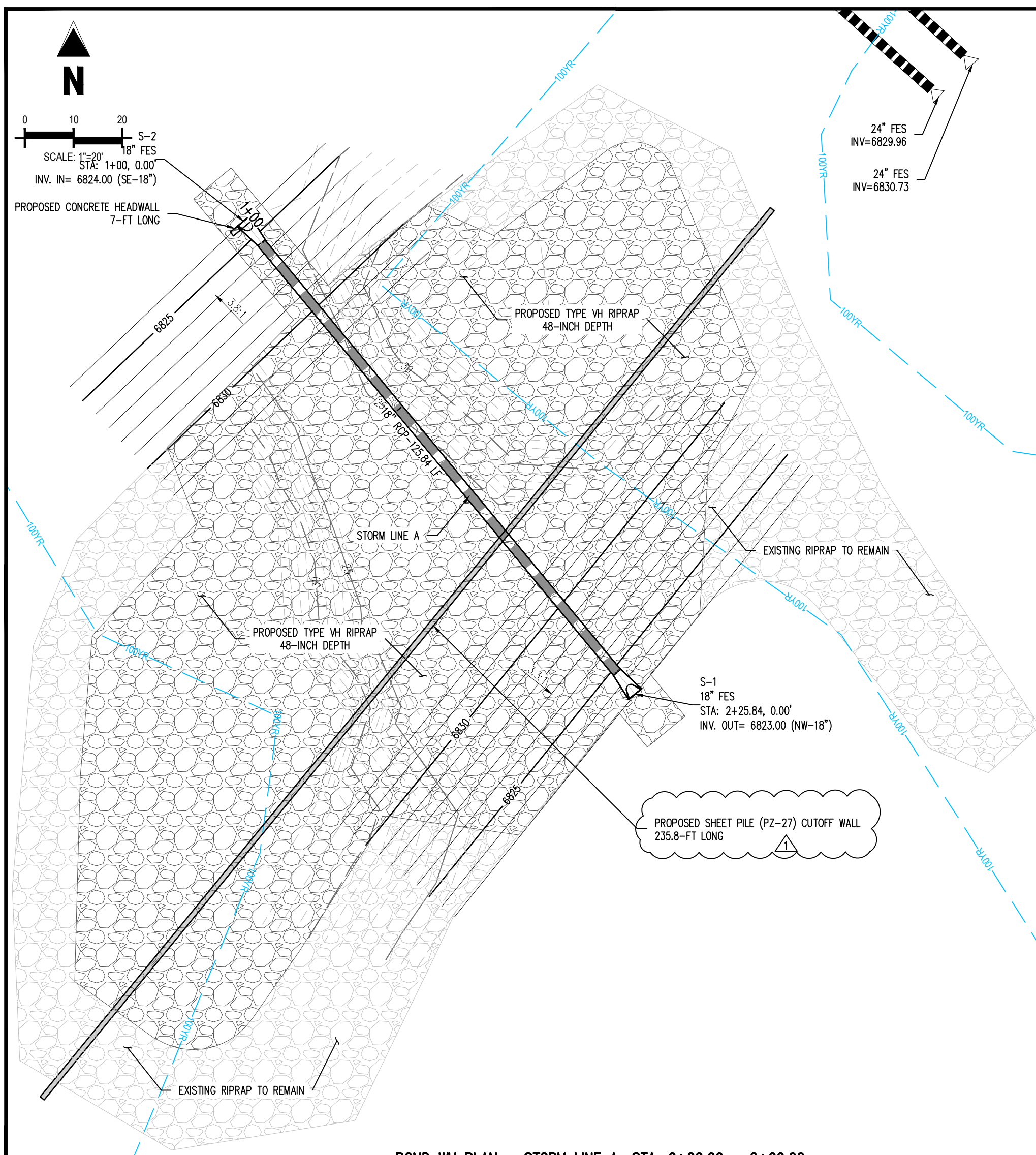

9-62 Urban Drainage and Flood Control District
Urban Storm Drainage Criteria Manual Volume 2
November 2016

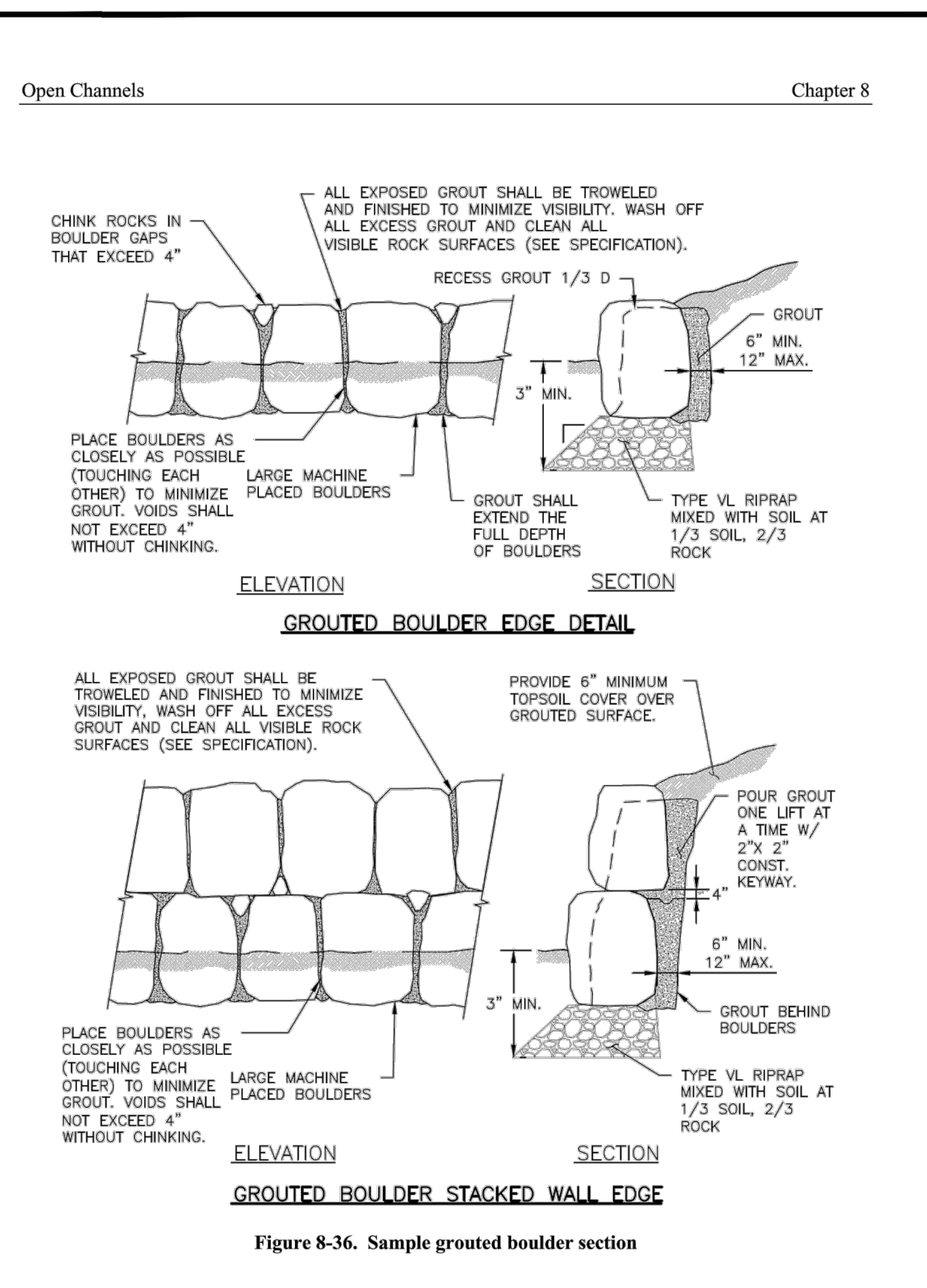

8-82 Urban Drainage and Flood Control District
Urban Storm Drainage Criteria Manual Volume 1
January 2016

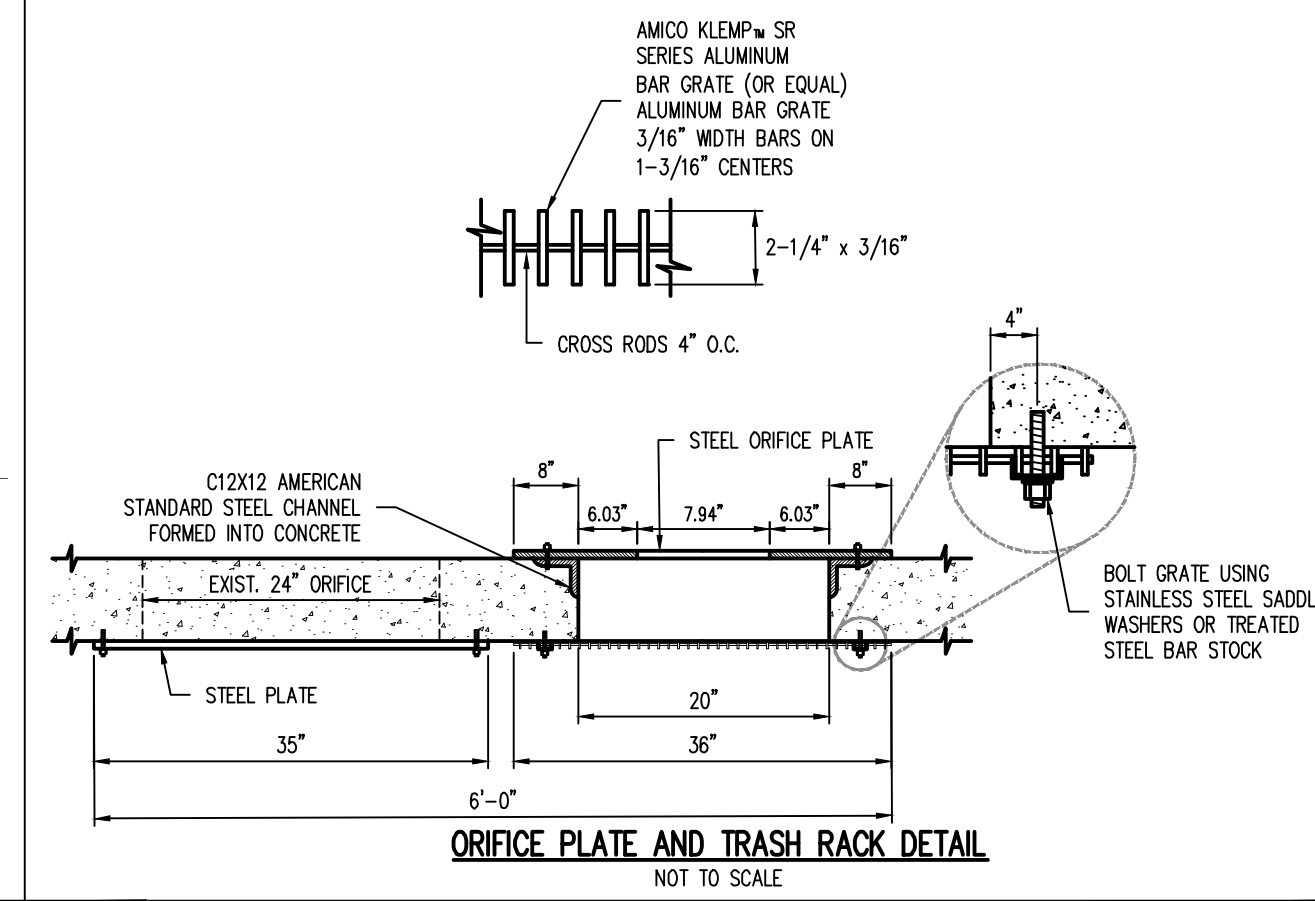
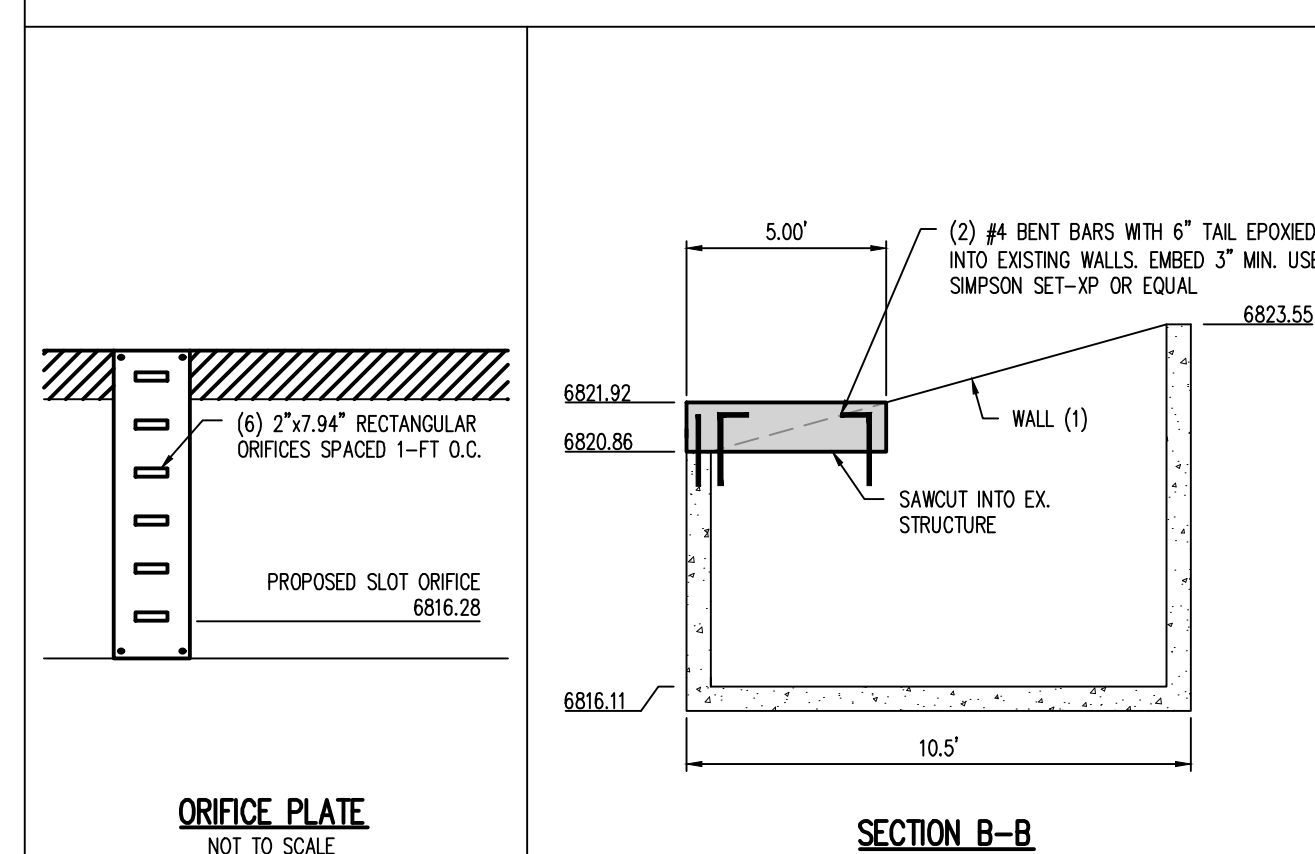
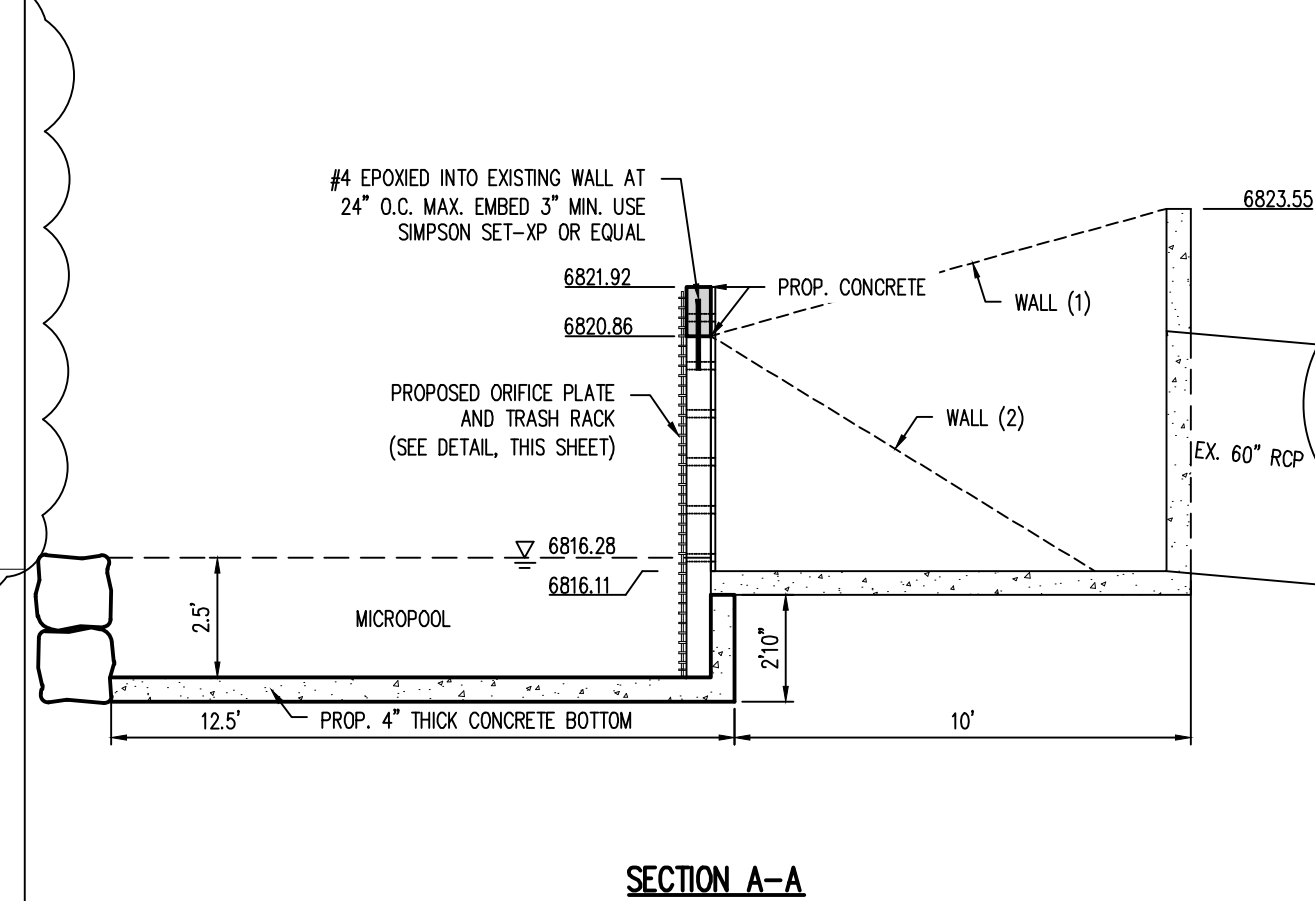
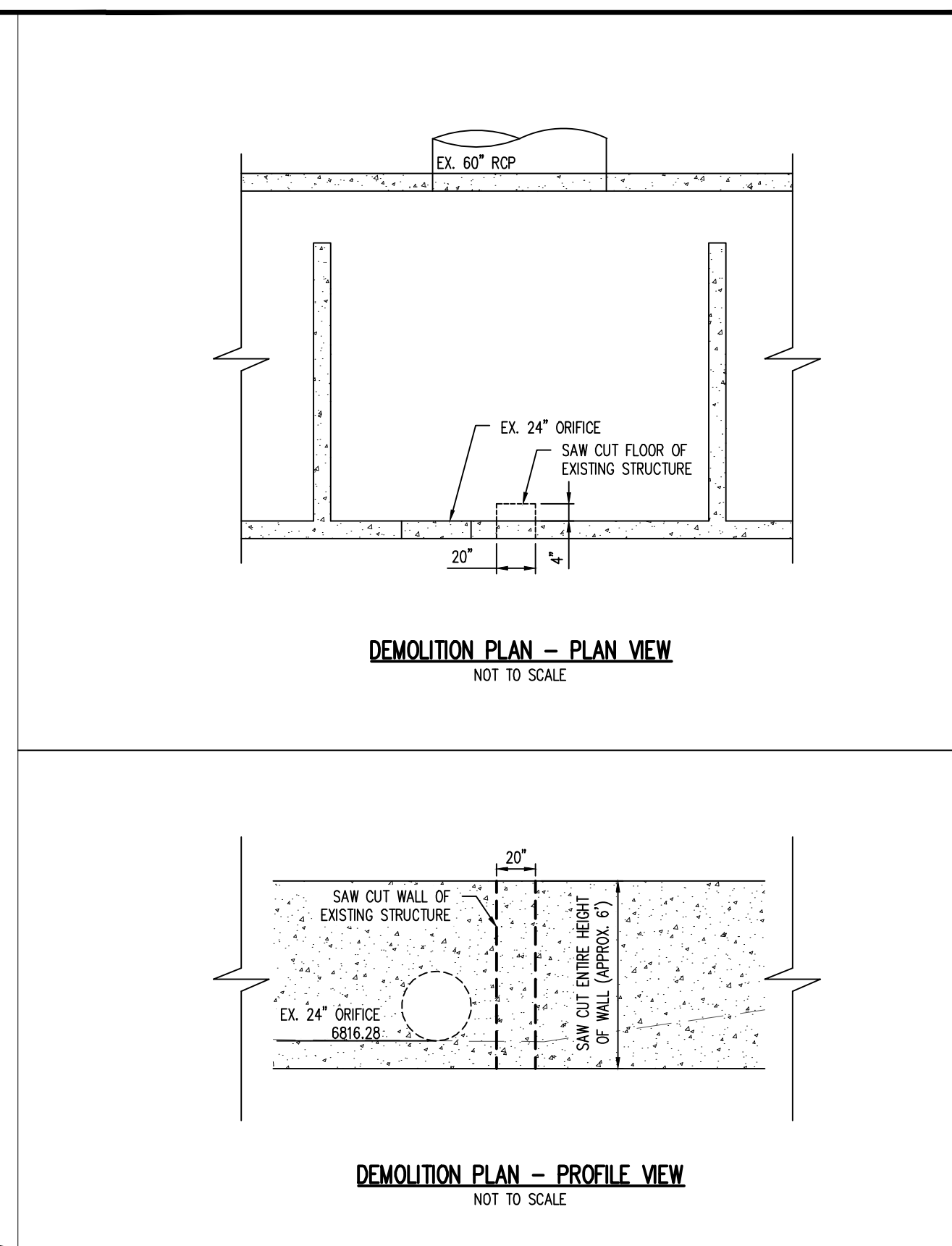
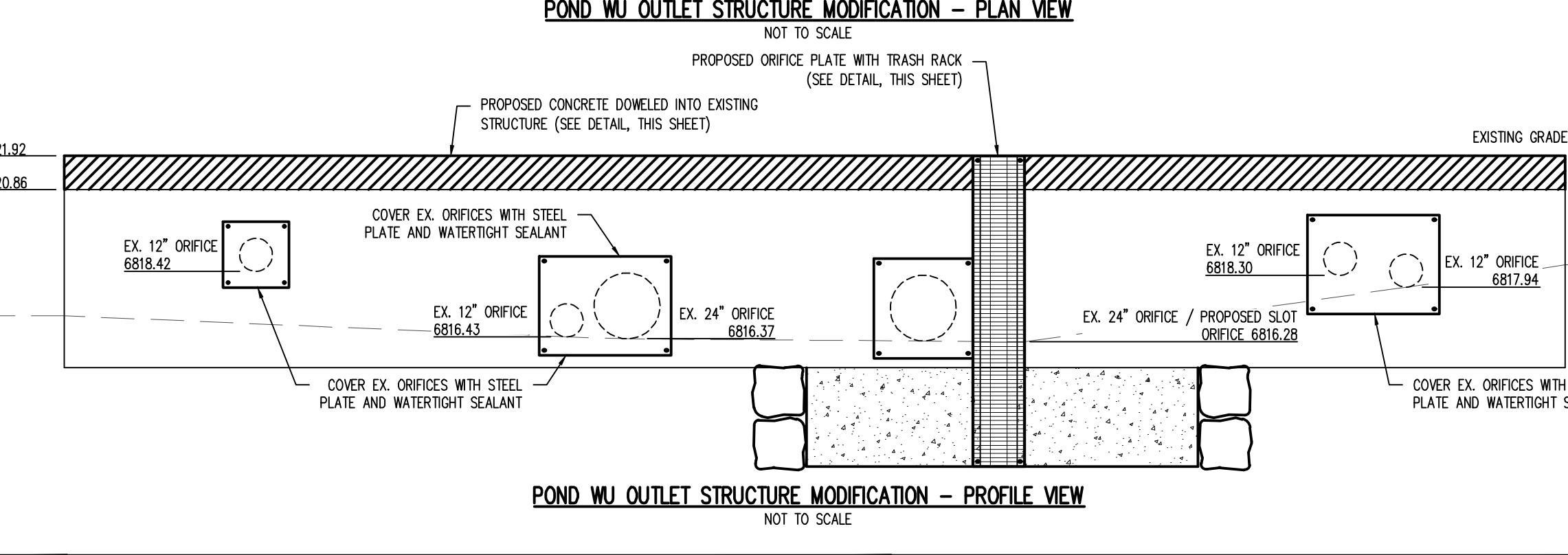
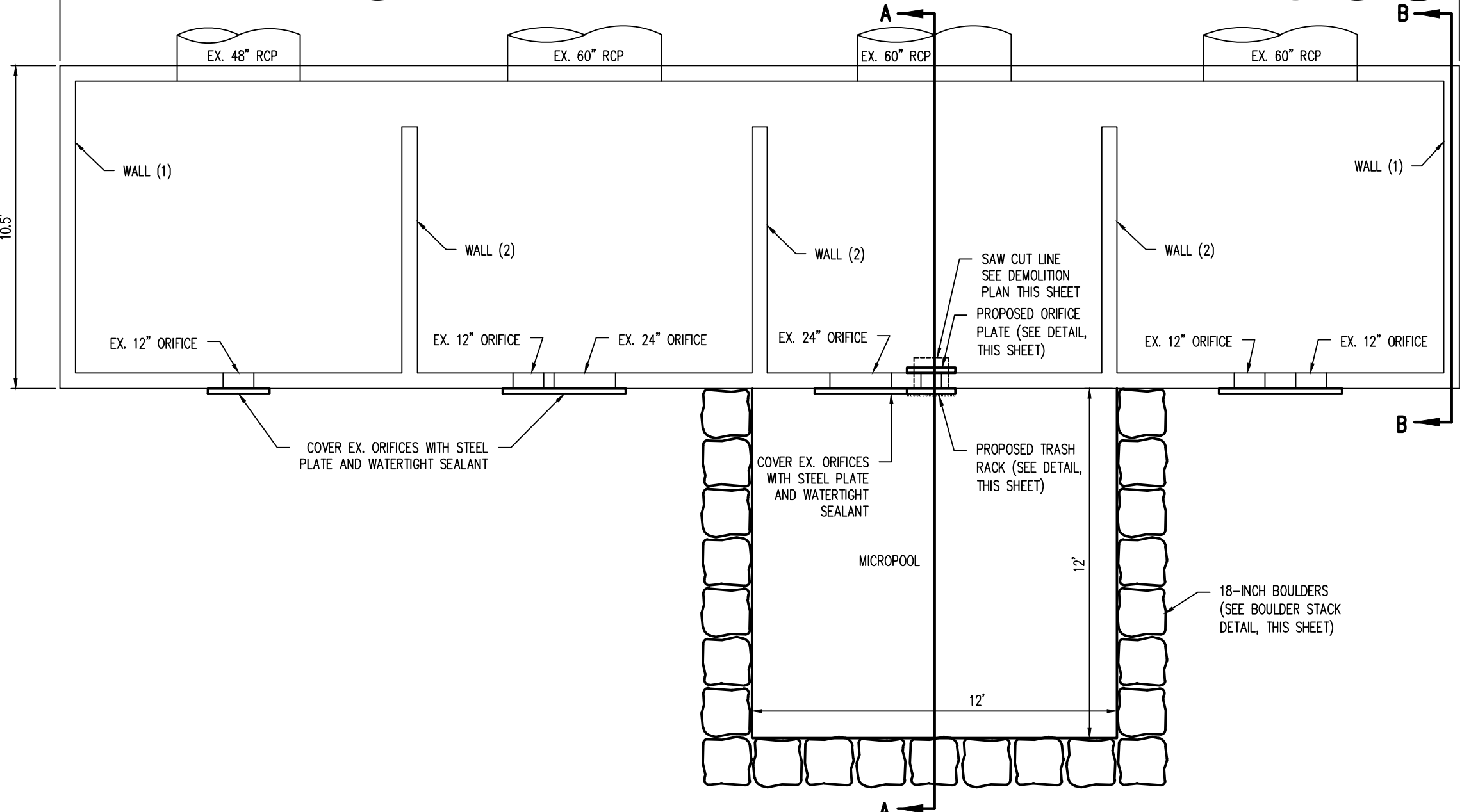
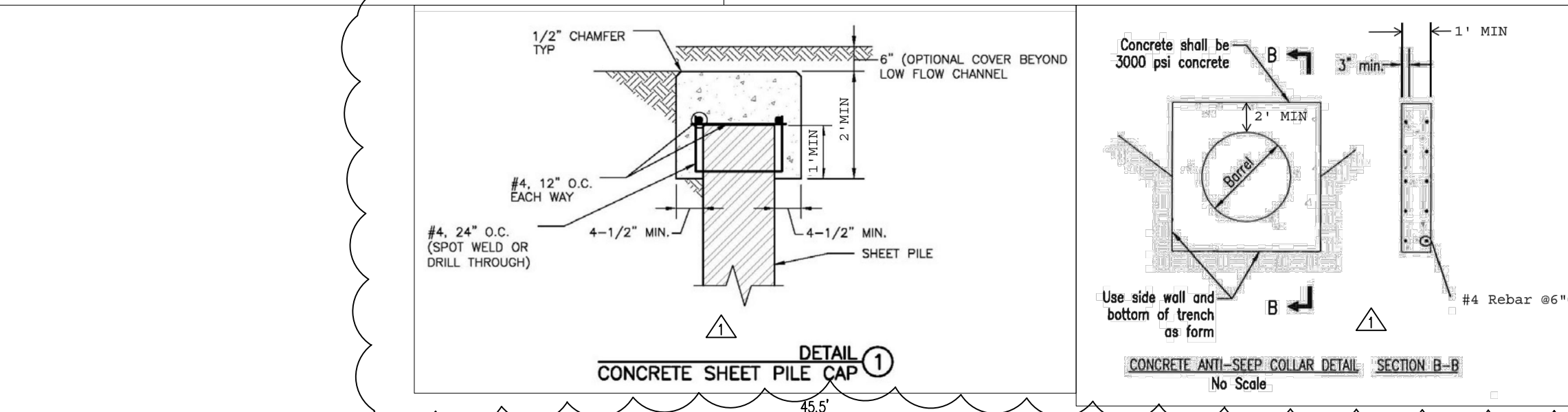

Galloway
1155 Kelly Johnson Blvd., Suite 305
Colorado Springs, CO 80920
719.900.7220
gallowayus.com

PROFESSIONAL ENGINEER
03/04/2021

COPYRIGHT
THESE PLANS ARE AN INSTRUMENT OF SERVICE AND ARE THE PROPERTY OF GALLOWAY, AND MAY NOT BE DUPLICATED, DISCLOSED, OR REPRODUCED WITHOUT THE WRITTEN CONSENT OF GALLOWAY. COPYRIGHTS AND INFRINGEMENTS WILL BE ENFORCED AND PROSECUTED.

CHALLENGER HOMES

FINAL GRADING & EROSION CONTROL PLANS
BENT GRASS RESIDENTIAL FILING NO. 2
FOR
CHALLENGER COMMUNITIES, LLC.
BENT GRASS MEADOWS DRIVE & MERIDIAN ROAD
FALCON, CO 80831 - EL PASO COUNTY

#	Date	Issue / Description	Init.
1	03/04/21	CUT OFF WALL TO SHEET PILE	RGD

APPROVED
Engineering Department
03/08/2021 9:37:35 AM
dsdnijkamp
EPC Planning & Community
Development Department

Project No: CLH000014.2D
Drawn By: JDP
Checked By: RGD
Date: 3/4/2021

FALCON DRAINAGE BASIN PLANNING STUDY
SELECTED PLAN REPORT
FINAL - SEPTEMBER 2015

Prepared for:



El Paso County Public Services Department
3275 Akers Drive
Colorado Springs, CO 80922

Prepared By:



Matrix Design Group
2435 Research Parkway, Suite 300
Colorado Springs, CO 80920

Matrix Project No. 10.122.003

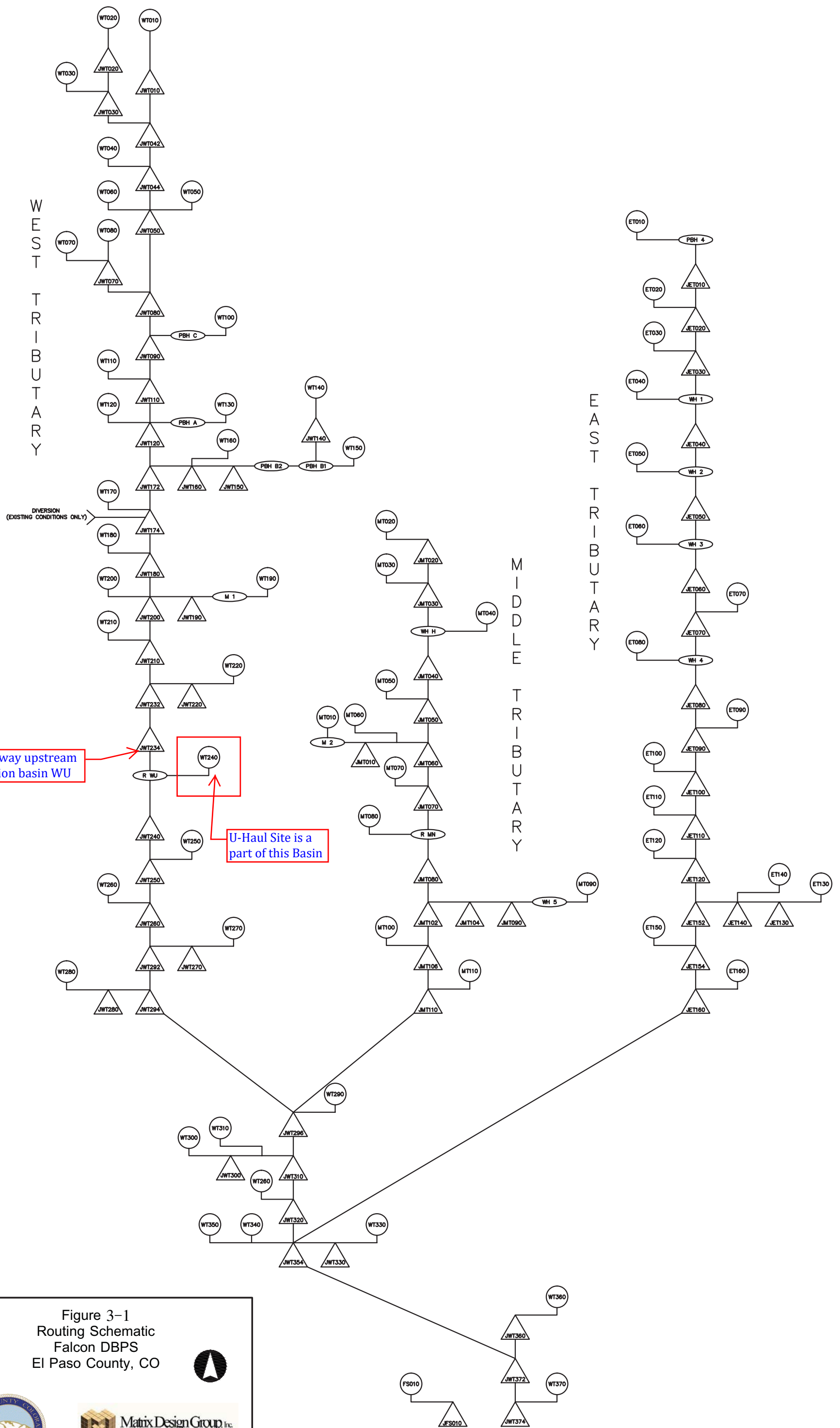

Figure 3-1
Routing Schematic
Falcon DBPS
El Paso County, CO



DRAWING NOT TO SCALE

Bridge and Culvert Crossing Replacements

The proposed size for crossing replacements includes the infrastructure necessary to provide the bridge or culvert with sufficient capacity to adhere to DCM criteria. Costs were estimated using a regression equation developed for this DBPS that was based on 2012 UDFCD master plan costs. Note that several crossings (e.g., WT 5-2, WT 4, WT 1, and MT 1) require such a large number of cells to comply with criteria that the proposed configurations are likely impractical. These locations may necessitate consideration of a more comprehensive capital improvement project including raising the roadway profile to achieve feasibility. The quantities and costs for all crossing replacements are provided in Table 6-11.

Table 6-11. Crossing Replacement Cost Estimate

Crossing	Location	Q100 (cfs)	Proposed Size	Length	Total Cost
WT 14	Burgess Rd.	89	5'	66	\$ 31,585
WT 13	Pine Park Trl.	89	5'	53	\$ 28,525
Pond WU Inlet Structure	Tamlin Rd.	1,110	(8) 6' x 12'	74	\$ 658,410
WT 6	Falcon Hwy.	1,000	(5) 6' x 12'	43	\$ 249,775
WT 5	Meridian Rd.	1,100	3'	43	\$ 8,651
WT 5-2	Meridian Rd.	1,100	(25) 3' x 10'	43	\$ 718,121
WT 4	W. Condor Rd.	1,500	(11) 5' x 12'	48	\$ 528,324
WT 3	Garrett Rd.	1,500	(3) 9' x 12'	46	\$ 218,292
WT 1	Blaney Rd.	2,200	(16) 5' x 12'	40	\$ 636,648
MT 7	Owl Ln.	299	(9) 2' x 4'	58	\$ 207,465
MT 6	Woodmen Rd.	840	(3) 5'	200	\$ 166,177
MT 6-2	Woodmen Rd.	840	(3) 5'	220	\$ 181,365
MT 5-1	McLaughlin Rd.	820	(3) 7' x 12'	48	\$ 191,098
MT 2	Swingline Rd.	840	(3) 8' x 12'	83	\$ 343,147
MT 1	Falcon Hwy.	860	(11) 4' x 12'	45	\$ 433,032
ET 31	Stapleton Dr.	200	(2) 4' x 12'	302	\$ 525,026
ET 19	Eastonville Rd.	530	7' x 10'	39	\$ 63,340
ET 13	Pinto Pony Rd.	300	(2) 6' x 8'	50	\$ 113,991
ET 11	Falcon Hwy.	400	(2) 6' x 8'	40	\$ 84,348
ET 10	N. Condor Rd.	590	(3) 7' x 10'	44	\$ 162,656
ET 9	Sunset Trl.	490	(2) 6' x 8'	40	\$ 84,102
ET 4	Garrett Rd.	640	(2) 5' x 8'	61	\$ 106,060
Subtotal					\$ 5,740,139
Engineering/Construction Admin. (15%)					\$ 861,021
Contingency (20%)					\$ 1,148,028
Total					\$ 7,749,187

No crossing improvements were necessary at WT 10, WT 7-2, MT 4, or ET 30 since the hydraulic condition at these locations were within criteria as noted in Table 6-7. Crossings WT 7-1, MT 3, and ET 14 were not resized because they are CDOT structures. Crossing WT 11 was not resized because it is located under a private drive. Other crossings, including WT 9, ET 32, ET 26, and ET 15, were not resized because the degree of criteria exceedance was so minor that they did not warrant replacement.

6.3.5. Immediate Action Required

There are 6 locations where immediate action is required in order to preserve the existing reach conditions as shown in Figure 6-1. These locations are at points adjacent to pristine channel reaches, or Natural Channel Design reaches, where current erosion or deposition has been identified. If left unmitigated, the issues at these locations have the potential to propagate and worsen the existing condition, thereby necessitating additional reach improvement costs. These locations can be addressed by implementing the recommended reach alternative for the impaired reach at the sites that are identified while improvements for the remainder of the impaired reaches can be constructed at a later date.

6.3.6. Protect In Place

There are several relatively pristine reaches of channel throughout the Falcon Watershed that are currently in a stable condition. Additionally, there are several reaches throughout the Falcon Watershed that have already been improved and appear to be stable. Preserving both of these reach conditions would not require a direct reach improvement cost. However, upstream detention improvements may be required depending on the location of the reach.

6.3.7. Reach Phasing Priority

Reach construction should be phased so that planned upstream detention ponds are constructed prior to reach construction. This method of phasing protects the reach alternatives from being damaged as a result of higher than designed for flows being released into the reach. A phasing priority of 1 means the reach can be constructed. Higher phasing priority numbers indicate more upstream detention ponds should be built prior to construction of the reach in question. The phasing priority for each of the reaches is provided in Appendix D.

6.4. Cost Summary

Costs for all detention ponds, reach improvements, bridge and culvert replacements, and roadside ditches are summarized in Table 6-12.

Table 6-12. Cost Summary

Alternative	Cost ¹
Detention Ponds	\$ 6,822,546
Roadside Ditches	\$ 835,874
Reaches ²	\$ 34,066,842
Bridge & Culvert Crossings	\$ 7,749,187
Total	\$ 49,474,449

Notes:

¹Includes all construction and additional costs

²Reaches includes both Natural Channel Design and Small Drop Structure reaches

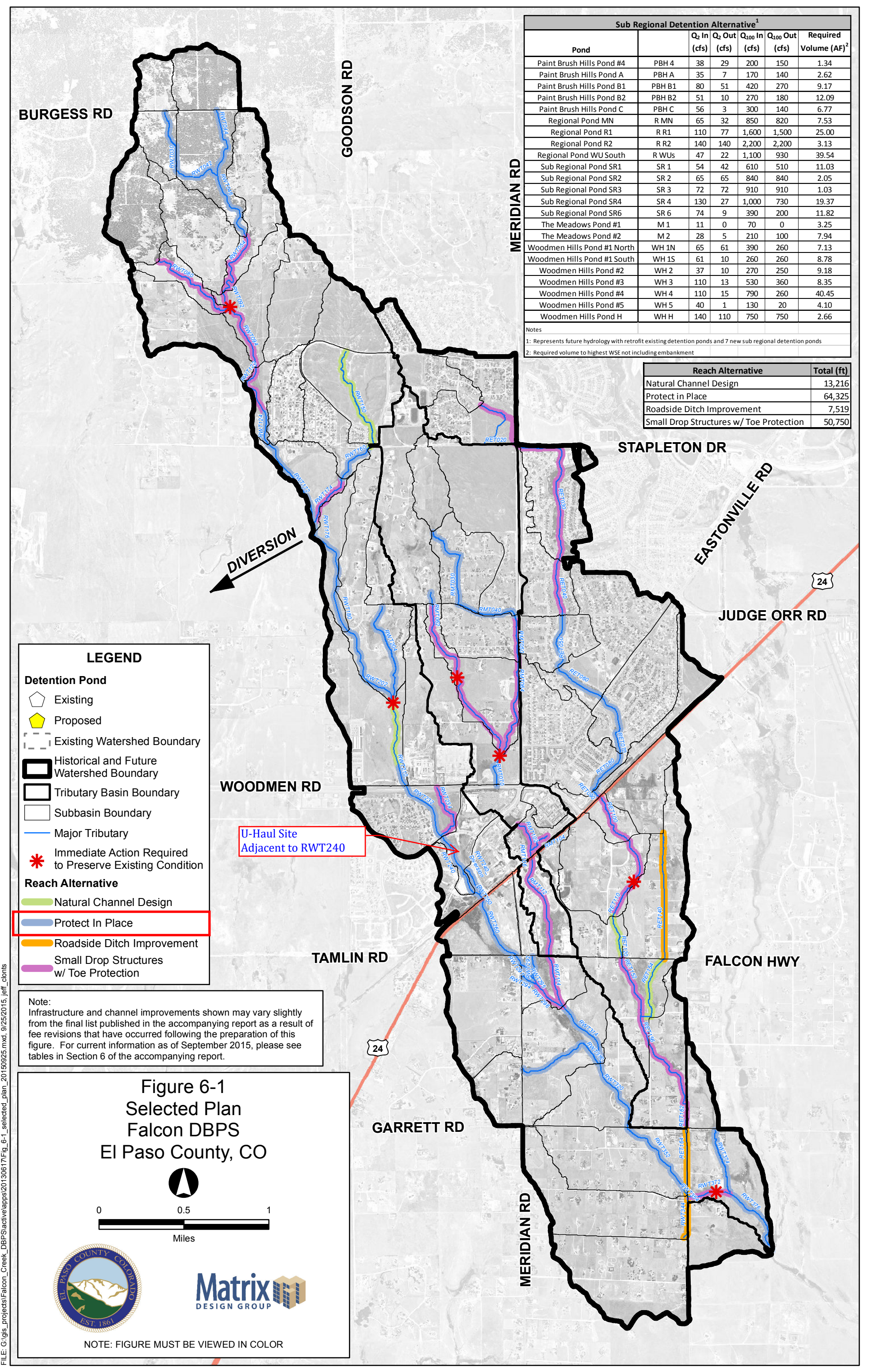

Sub Regional Detention Alternative ¹						
Pond		Q ₂ In (cfs)	Q ₂ Out (cfs)	Q ₁₀₀ In (cfs)	Q ₁₀₀ Out (cfs)	Required Volume (AF) ²
Paint Brush Hills Pond #4	PBH 4	38	29	200	150	1.34
Paint Brush Hills Pond A	PBH A	35	7	170	140	2.62
Paint Brush Hills Pond B1	PBH B1	80	51	420	270	9.17
Paint Brush Hills Pond B2	PBH B2	51	10	270	180	12.09
Paint Brush Hills Pond C	PBH C	56	3	300	140	6.77
Regional Pond MN	R MN	65	32	850	820	7.53
Regional Pond R1	R R1	110	77	1,600	1,500	25.00
Regional Pond R2	R R2	140	140	2,200	2,200	3.13
Regional Pond WU South	R WUs	47	22	1,100	930	39.54
Sub Regional Pond SR1	SR 1	54	42	610	510	11.03
Sub Regional Pond SR2	SR 2	65	65	840	840	2.05
Sub Regional Pond SR3	SR 3	72	72	910	910	1.03
Sub Regional Pond SR4	SR 4	130	27	1,000	730	19.37
Sub Regional Pond SR6	SR 6	74	9	390	200	11.82
The Meadows Pond #1	M 1	11	0	70	0	3.25
The Meadows Pond #2	M 2	28	5	210	100	7.94
Woodmen Hills Pond #1 North	WH 1N	65	61	390	260	7.13
Woodmen Hills Pond #1 South	WH 1S	61	10	260	260	8.78
Woodmen Hills Pond #2	WH 2	37	10	270	250	9.18
Woodmen Hills Pond #3	WH 3	110	13	530	360	8.35
Woodmen Hills Pond #4	WH 4	110	15	790	260	40.45
Woodmen Hills Pond #5	WH 5	40	1	130	20	4.10
Woodmen Hills Pond H	WH H	140	110	750	750	2.66

Notes
 1: Represents future hydrology with retrofit existing detention ponds and 7 new sub regional detention ponds
 2: Required volume to highest WSE not including embankment

Reach Alternative	Total (ft)
Natural Channel Design	13,216
Protect in Place	64,325
Roadside Ditch Improvement	7,519
Small Drop Structures w/ Toe Protection	50,750

LEGEND

Detention Pond
 Existing
 Proposed

Existing Watershed Boundary
 Historical and Future Watershed Boundary
 Tributary Basin Boundary
 Subbasin Boundary
 Major Tributary

Reach Alternative
 Natural Channel Design
 Protect In Place
 Roadside Ditch Improvement
 Small Drop Structures w/ Toe Protection

Note:
 Infrastructure and channel improvements shown may vary slightly from the final list published in the accompanying report as a result of fee revisions that have occurred following the preparation of this figure. For current information as of September 2015, please see tables in Section 6 of the accompanying report.

Figure 6-1
 Selected Plan
 Falcon DBPS
 El Paso County, CO



NOTE: FIGURE MUST BE VIEWED IN COLOR

Sheet 6-9 Falcon DBPS Conceptual Plan West Tributary El Paso County, CO

- Drainageway Crossing
 - Stream Centerline
 - Existing Approximate 100-yr Floodplain*
 - Floodplain Study Limit
 - Storm Sewer**
 - Inlet
 - Manhole
 - Pipe
 - Reach Improvements**
 - Natural Channel Design
 - Protect In Place
 - Roadside Ditch Improvement
 - Small Drop Structures w/ Toe Protection
 - Existing Detention
 - Proposed Detention
 - Proposed Detention Grading
 - Small Drop Structure
 - Cross Vane
 - Immediate Action Required to Preserve Existing Condition
- 0 100 200 Feet

Regional Pond WU South
 EURV = 14 AF
 100-yr Volume = 40 AF
 Q_{2 in} = 47 cfs
 Q_{2 out} = 22 cfs
 Q_{100 in} = 1100 cfs
 Q_{100 out} = 930 cfs
 See Detail on Sheet 6-55

Approximate Limits of Split Flow for Existing 100-yr Floodplain

Pond WU Inlet Structure - Tamlin Rd.
 EX Size: 1.5' Circular RCP (x3)
 PR Size: 12' (W) x 6' (H) Concrete Box (x8)

WT 9 - Meridian Rd.
 EX Size: 10' (W) x 6' (H) Concrete Box (x4)

RWU Outlet

WT 7-2 - Rail Road
 EX Size: 54' (W) x 7.41' (H) Wood Bridge

WT 7-1 - Hwy. 24
 EX Size: 12' (W) x 6' (H) Concrete Box (x3)

Small Drop Structure
 See Detail on Sheet 6-54

U-Haul Site

Note:
 Infrastructure and channel improvements shown may vary slightly from the final list published in the accompanying report as a result of fee revisions that have occurred following the preparation of this figure. For current information as of September 2015, please see tables in Section 6 of the accompanying report.

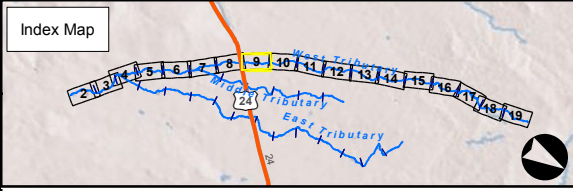

FILE: G:\gis\projects\Falcon_Creek_DBPS\active\apps\20130617\mapbook\sel\Alt West Trib. 20151230.mxd, 1/11/2016, Jeff Clonts

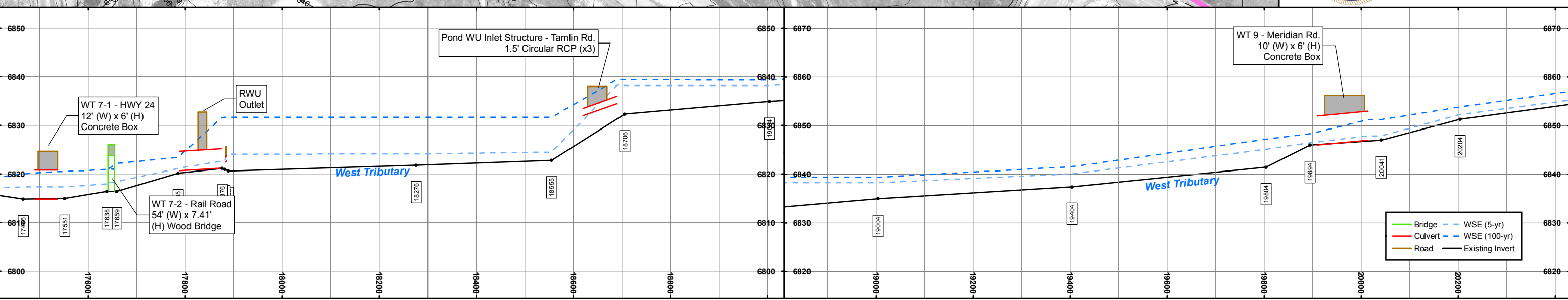

APPENDIX E

Exhibit A: Drainage Plan – Existing Conditions

Exhibit B: Drainage Plan – Proposed Conditions

LEGEND

A
1.84 AC
0.76 0.83
C5 RUNOFF COEF

PROPOSED BASIN DESIGNATION
DRAINAGE BASIN ACRES
C100 RUNOFF COEFFICIENT

EXISTING DRAINAGE BASIN BOUNDARY

DESIGN POINT
STORMWATER EMERGENCY OVERFLOW PATH
R.O.W. / PROPERTY LINE
EXISTING EASEMENT
EXISTING STORM SEWER
EXISTING CONTOURS
EXISTING FLOW DIRECTION AND SLOPE
EXISTING 100 YEAR FLOODPLAIN
EXISTING TIME OF CONCENTRATION PATH

SUB-BASIN AND DESIGN POINT DISCHARGES

BASIN & DESIGN POINT	CONTRIBUTING BASINS	5-YR FLOW	100-YR FLOW
EX-A		0.4 cfs	2.9 cfs
EX-B		3.0 cfs	21.7 cfs
EX-C		0.0 cfs	0.3 cfs
OS-1		1.4 cfs	2.6 cfs
DP 23		40.0 cfs	70.9 cfs
DP E1	DP23, EX-B, OS-1	37.7 cfs	83.3 cfs

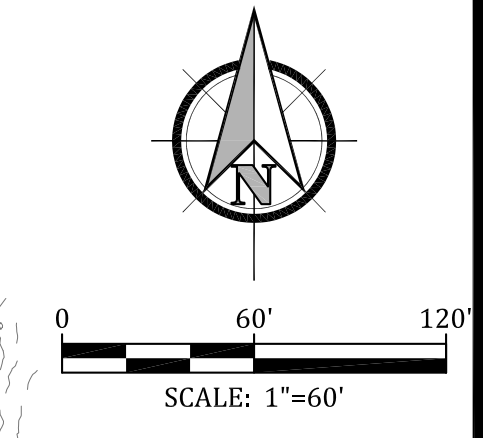
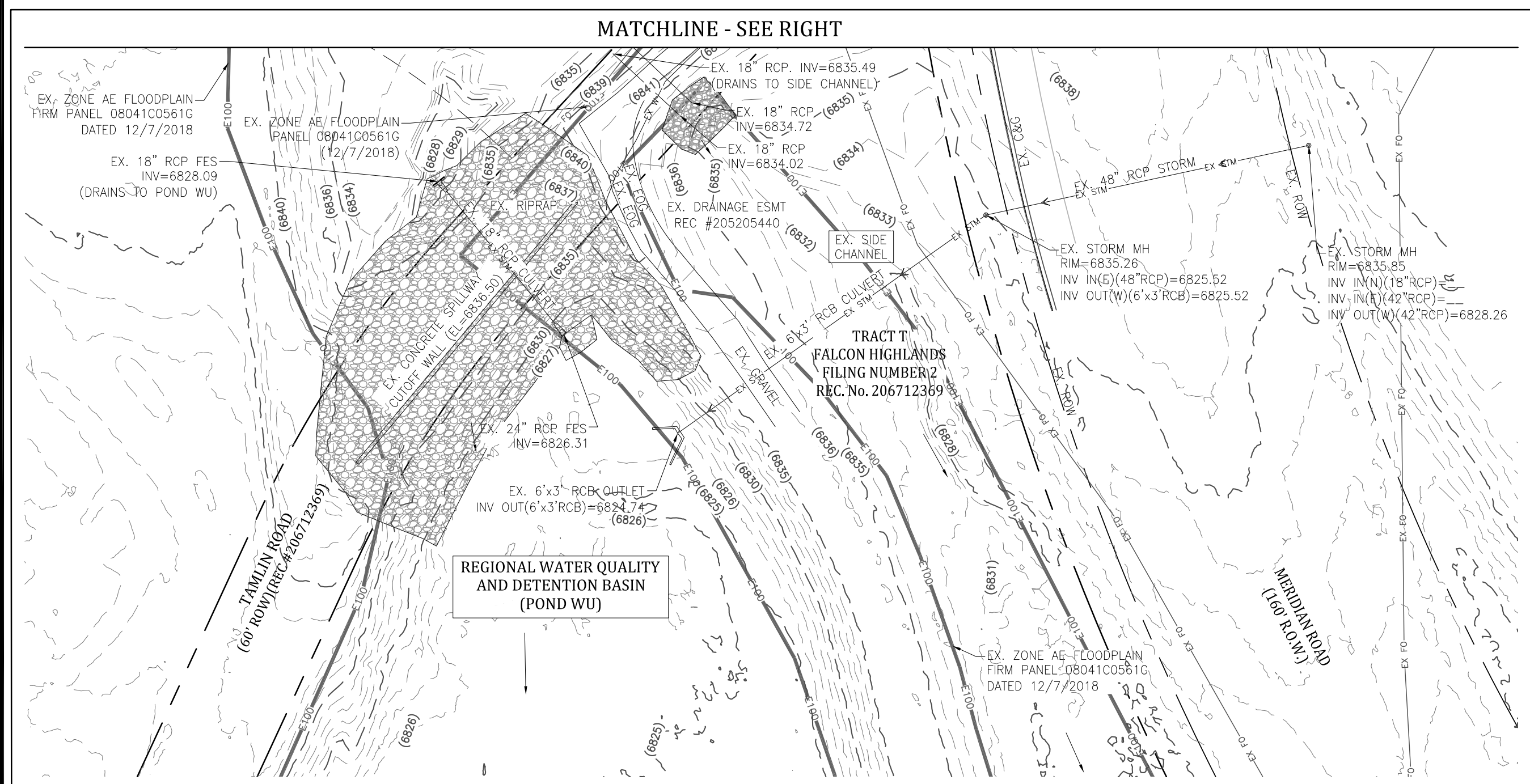

GENERAL NOTES:

REVISIONS:

NO.	DATE	INITIALS	NOTES
1			
2			
3			
4			
5			
6			
7			
8			

PROFESSIONAL SEAL:

Kiowa
Engineering Corporation
7175 West Jefferson Avenue, Suite 2500
Lakewood, CO 80125
(303) 692-0369

AMERCO
REAL ESTATE COMPANY

CONSTRUCTION DEPARTMENT
2727 NORTH CENTRAL AVENUE
PHOENIX, ARIZONA 85004
P: (602) 263-6502
F: (602) 277-1026

SITE ADDRESS:
U-HAUL at Falcon
Rolling Thunder Way
Falcon, CO 80831

SHEET CONTENTS:
DRAINAGE PLAN -
EXISTING CONDITIONS

866077

DRAWN: JRD	A
CHECKED: MWE	
DATE: 8/26/22	

© COPYRIGHT AMERCO REAL ESTATE COMPANY

LEGEND

A PROPOSED BASIN DESIGNATION
 1.84 AC DRAINAGE BASIN ACRES
 0.76 0.83 C100 RUNOFF COEFFICIENT

DIRECTIONAL FLOW ARROW
 DRAINAGE BASIN BOUNDARY
 HYDRAULIC STRUCTURE IDENTIFIER
 STORM SEWER IDENTIFIER

DESIGN POINT
 STORMWATER EMERGENCY OVERFLOW PATH
 R.O.W. / PROPERTY LINE
 EXISTING EASEMENT
 EXISTING STORM SEWER
 EXISTING CONTOURS
 PROPOSED CONTOURS
 EXISTING FLOW DIRECTION AND SLOPE
 PROPOSED FLOW DIRECTION AND SLOPE
 PROPOSED SLOPE
 PROPOSED CURB AND GUTTER
 EXISTING 100 YEAR FLOODPLAIN
 PROPOSED TIME OF CONCENTRATION CHOSEN PATH
 PROPOSED STORM SEWER PIPE AND MANHOLE
 PROPOSED STORM GRATED INLET
 PROPOSED STORM CURB INLET

SUB-BASIN AND DESIGN POINT DISCHARGES

BASIN & DESIGN POINT	CONTRIBUTING BASINS	5-YR FLOW	100-YR FLOW
OS-1		1.4 cfs	2.6 cfs
A		4.5 cfs	8.8 cfs
B		9.1 cfs	16.4 cfs
C		2.0 cfs	4.2 cfs
D		0.1 cfs	0.4 cfs
E		1.4 cfs	2.6 cfs
F.1		1.0 cfs	1.8 cfs
F.2		2.1 cfs	3.9 cfs
G		1.2 cfs	2.6 cfs
H		0.3 cfs	0.5 cfs
J		2.6 cfs	4.9 cfs
K		2.3 cfs	8.6 cfs
K-Dev		9.3 cfs	17.9 cfs
L		0.4 cfs	2.6 cfs
L-Dev		3.5 cfs	6.8 cfs
DP 1	A, D, E	5.6 cfs	11.2 cfs
DP 1A	H, DP 1	5.7 cfs	11.3 cfs
DP 2	OS-1, B	9.5 cfs	17.1 cfs
DP 3	DP 1A, DP 2	14.5 cfs	28.0 cfs
DP 4	C, F.1	2.9 cfs	5.9 cfs
DP 5	F.2, G	3.1 cfs	6.2 cfs
DP 6	K, L	2.7 cfs	11.1 cfs
DP 23		40.0 cfs	70.9 cfs
DP 24	DP 4, DP 23	42.6 cfs	76.2 cfs
DP 25	DP 5, DP 24	45.0 cfs	81.1 cfs
DP 26	J, DP 3, DP 25	59.5 cfs	108.1 cfs
DP 27	L, DP 26	58.3 cfs	108.1 cfs
DP 27-Dev	L-Dev, DP 26	60.9 cfs	113.7 cfs
DP 28	K, DP 27	60.3 cfs	116.2 cfs
DP 28-Dev	K-Dev, DP 27	68.3 cfs	127.9 cfs

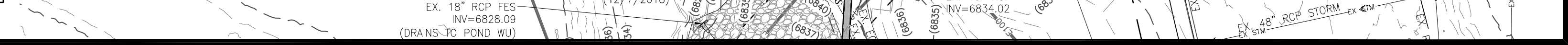
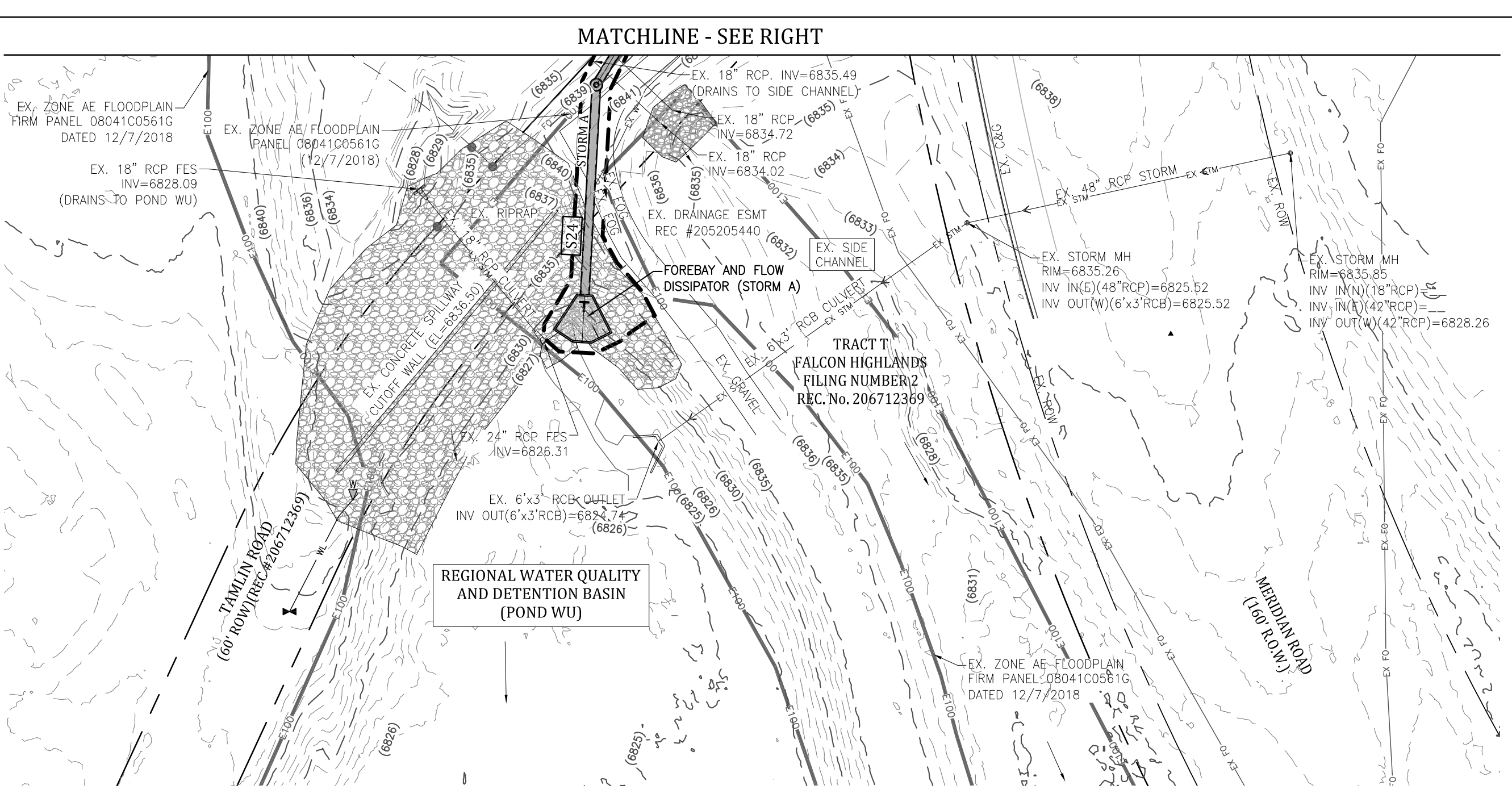

GENERAL NOTES:

REVISIONS:

NO.	DATE	INITIALS	NOTES
1			
2			
3			
4			
5			
6			
7			
8			

PROFESSIONAL SEAL:

Kiowa
 Engineering Corporation
 7175 West Jefferson Avenue, Suite 2500
 Lakewood, CO 80226
 (303) 692-0369

AMERCO
 REAL ESTATE COMPANY

CONSTRUCTION DEPARTMENT
 2727 NORTH CENTRAL AVENUE
 PHOENIX, ARIZONA 85004
 P: (602) 263-6502
 F: (602) 277-1026

SITE ADDRESS:
 U-HAUL at Falcon
 Rolling Thunder Way
 Falcon, CO 80831

SHEET CONTENTS:
 DRAINAGE PLAN -
 PROPOSED CONDITIONS

866077

DRAWN: JRD
 CHECKED: MWE
 DATE: 8/26/22

B

© COPYRIGHT AMERCO REAL ESTATE COMPANY